

MPLUS

SUPPLEMENTARY PRODUCT LINE
FOR SPECIFIC APPLICATIONS



Mplus...

NEW

MITSUBISHI MATERIALS

INTRODUCING THE NEW GENERAL CATALOGUE C009 – 2022/2023

TARGETED, COMPACT, HANDY.

Mitsubishi Materials' wide product portfolio is now shown in catalogues that represent individual application areas, offering users fast and easy access to targeted product information.

There is now a set of catalogues in small, practical sizes that comprise the following five volumes:

- **TURNING TOOLS**
- **DRILLING TOOLS**
- **SOLID MILLING TOOLS**
- **INDEXABLE MILLING TOOLS**
- **MPLUS**

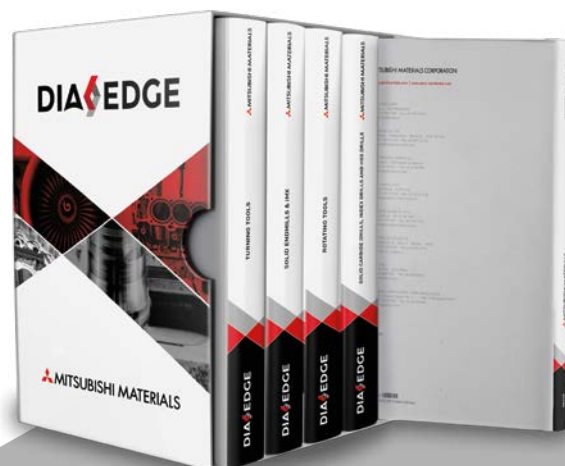

NEW DESIGN

EASY HANDLING

HIGHER FLEXIBILITY

INDIVIDUAL APPLICATION AREAS

The slipcase provided enables easy storage and offers the required space for all future catalogues, including the product news brochures that will be published within the 2-year life cycle of the catalogue. Each new product news brochure published within the 2-year cycle will completely replace the previous version. Therefore, please dispose of old versions when new ones are supplied to ensure that the collection is up to date.

NOTES:

- With this publication, all previous general catalogues and product news brochures lose their validity.
- The product news catalogues are released twice a year, in April and October.
- The new general catalogue can be ordered only as a set of five. **Order number: C009E**



DIGITAL VERSION

For the digital version of the catalogue, please scan the QR code or visit us at www.mhg-mediastore.net

MPLUS



COOPERATION - OVERCOMING BOUNDARIES

MPlus is a complementary product line that enriches the existing product range.

A wide range of supplementary tools in cooperation with partners across Europe that meet specific customer needs.

Outstanding tools and sophisticated tooling solutions for the metalworking industry.

Mplus...



MPLUS TOOLING

**SUPPLEMENTARY PRODUCT LINE
FOR SPECIFIC APPLICATIONS**

INDEX

TURNING TOOLS

MINI-EY-IC/MINI-EY

Precision grooving system. With and without internal coolant supply.

6

INDEXABLE MILLING TOOLS

ARM

Multi-functional high feed cutter for mould & die machining.

17

SIDE AND FACE MILLING CUTTER SERIES

Side and face machining with low cutting resistance, vertical mount, double-sided inserts for DCV series.

26

LSE445-E

General purpose face milling cutters.

41

NSE300-E/NSE400-E

Shoulder milling cutter for general machining.

45

RRD

Round insert type cutters – Versatile performance and long tool life.

48

DRILLING TOOLS

TAF

Indexable insert drill – Featuring a tough body that creates low drilling noise.

63

MINI-EY-SERIES

PRECISION GROOVING SYSTEM



Mplus...

MINI-EY-IC

WITH INTERNAL COOLANT

The new advanced Mini-EY-IC series with internal coolant supply provides a positive step in usability. The improved coolant supply reduces heat generation as well as enabling longer tool life. Optimised chip control and higher cutting parameters, plus increased wear resistance means greater efficiencies can be achieved.

PRODUCT RANGE

- Insert width: 2 mm and 3 mm
- Holder size: 12 x 12, 16 x 16, 20 x 20
- Hand: R/L
- Max. cut off diameter: Ø 25 mm, 32 mm, 42 mm

APPLICATION

- External grooving and cut off

FEATURES

- Higher cutting parameters
- Cost effective double sided inserts
- Sizes 12 & 16 with clamping screw axis tilted at 115° for easy, on machine access
- Internal coolant supply

LONGER TOOL LIFE

EXCELLENT SURFACES

IMPROVED CHIP CONTROL

INCREASED WEAR RESISTANCE

WITH INTERNAL COOLANT



MINI-EY

WITH EXTERNAL COOLANT

The Mini-EY is designed for swiss-type lathes as a precision grooving system. A range of suitable insert grades and chipbreakers makes it usable for steels, stainless steels, cast irons and difficult-to-cut materials. Complete with economical double sided inserts.

PRODUCT RANGE

- Insert width: 1.5 mm – 3.0 mm
- Holder size: 10x10, 12x12, 16x16
- Hand: R/L
- Max. cut off diameter: Ø 25 mm, 32 mm

APPLICATION

- External grooving and cut off

FEATURES

- Cost effective double sided Inserts
- Designed for swiss-type lathes



LONG TOOL LIFE

GOOD SURFACE FINISHES

EXCELLENT CHIP CONTROL

TMplus...

MINI-EY-IC

WITH INTERNAL COOLANT SUPPLY

00° type mono block holder

Insert	GY2M○○○○○○○○○○	-GS -GM	Insert	GY2M○○○○○○○○○○	-GS -GM
Insert	GY2M○○○○○○○○○○	-GU	Insert	GY2M○○○○○○○○○○	-GU
Insert	GY2G○○○○○○○○○○	-MF	Insert	GY2M○○○○○○○○R/L○○	-GM

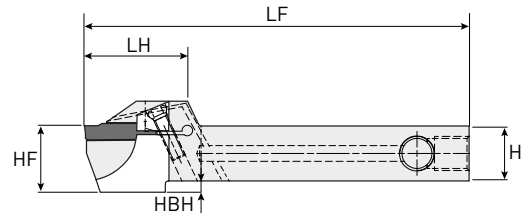
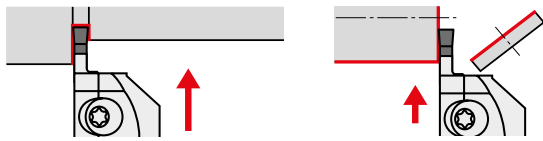

Right hand tool holder shown.

Order number	Stock	Seat size	CW	Hand	CDX	CUTDIA	H	B	LF	LH	HF	HBH
EYHL1212D125-IC	●	D	2.0	L	12.5	25	12	12	110	30	16	4
EYHR1212D125-IC	●			R	12.5	25	12	12	110	30	16	4
EYHL1212F125-IC	●	F	3.0	L	12.5	25	12	12	110	30	16	4
EYHR1212F125-IC	●			R	12.5	25	12	12	110	30	16	4
EYHL1616D160-IC	●	D	2.0	L	16.0	32	16	16	110	33.5	16	—
EYHR1616D160-IC	●			R	16.0	32	16	16	110	33.5	16	—
EYHL1616F160-IC	●	F	3.0	L	16.0	32	16	16	110	33.5	16	—
EYHR1616F160-IC	●			R	16.0	32	16	16	110	33.5	16	—
EYHL2020F210-IC	●	F	3.0	L	21.0	42	20	20	125	37	20	—
EYHR2020F210-IC	●			R	21.0	42	20	20	125	37	20	—

1. When using insert widths 2.39 mm and 2.50 mm with E type seat sizes, in F type holders, the centre height will differ.
2. Dimensions shown are when the gauge insert is used. If other insert geometries are used then LF, LH and HF values may vary.
3. Size 12 holder without socket.
4. Sizes 12 & 16 with clamping screw axis tilted at 115° for easy on machine access.







MINI-EY-IC

CUTTING MODE AND INSERTS

Holder number	Cutting mode (Right hand holder shown)	Insert Geometry/Insert number
EYHC1212D125-IC		GY2M0300F030N-GU
EYHC1212F125-IC		GY2M0200D020N-GU
EYHC1616D160-IC		GY2M0200D020N-GS
EYHC1616F160-IC		GY2M0300F020N-GS
EYHC2020F210-IC		GY2M0200D020N-GM
		GY2M0300F030N-GM
		GY2M0200D020R05-GM
		GY2M0200D020L05-GM
		GY2M0300F030R05-GM
		GY2M0300030L05-GM

1. ○ = R/L

SPARE PARTS

Holder number	 Clamp screw	 Wrench	 Plug	 Adaptor
EYHC1212D125-IC			Plug-M08-100-05	—
EYHC1212F125-IC				
EYHC1616D160-IC	TS406 (Clamp Torque: 3.5 Nm)	TKY15R		
EYHC1616F160-IC			Plug-G1/8-05	Socket-G1/8
EYHC2020F210-IC				

1. Wrench : z : Clamp screw

2. ○ = R/L

MINI-EY

WITH EXTERNAL COOLANT SUPPLY

00° type mono block holder

Insert	GY2M○○○○○○○○○○	-GS	Insert	GY2M○○○○○○○○○○	-GS
		-GM			-GM
Insert	GY2M○○○○○○○○○○	-GU	Insert	GY2M○○○○○○○○○○	-GU
Insert	GY2G○○○○○○○○○○	-MF	Insert	GY2M○○○○○○○○○○R/L○○	-GM

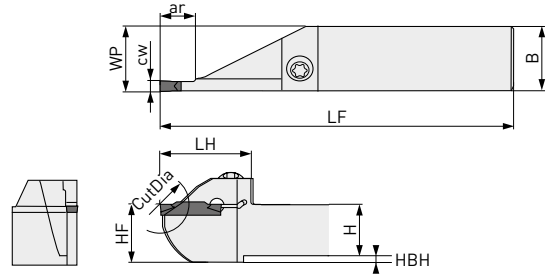
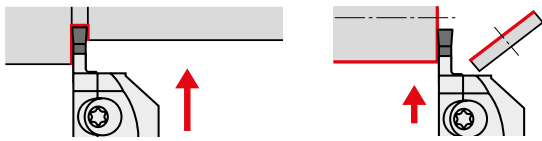

Right hand tool holder shown.

Order number	Stock	Seat size	CW	Hand	CDX	CUTDIA	H	B	LF	LH	HF	HBH
EYHR1212C125	●	C	1.5	R	12.5	25	12	12	110	20	16	4
EYHL1212C125	●			L	12.5	25	12	12	110	20	16	4
EYHR1010D125	●	D	2.0	R	12.5	25	10	10	110	20	14	4
EYHL1010D125	●			L	12.5	25	10	10	110	20	14	4
EYHR1212D125	●	D	2.0	R	12.5	25	12	12	110	20	16	4
EYHL1212D125	●			L	12.5	25	12	12	110	20	16	4
EYHR1212F125	●	F	3.0	R	12.5	25	12	12	110	20	16	4
EYHL1212F125	●			L	12.5	25	12	12	110	20	16	4
EYHR1616C135	●	C	1.5	R	13.5	27	16	16	110	22	16	—
EYHL1616C135	●			L	13.5	27	16	16	110	22	16	—
EYHR1616D160	●	D	2.0	R	16	32	16	16	110	22	16	—
EYHL1616D160	●			L	16	32	16	16	110	22	16	—
EYHR1616F160	●	F	3.0	R	16	32	16	16	110	22	16	—
EYHL1616F160	●			L	16	32	16	16	110	22	16	—

1. When using insert widths 2.39 mm and 2.50 mm with E type seat sizes, in F type holders, the centre height will differ.
2. Dimensions shown are when the gauge insert is used. If other insert geometries are used then LF, LH and HF values may vary.

MINI-EY



CUTTING MODE AND INSERTS

Holder number	Cutting mode (Right hand holder shown)	Insert Geometry/Insert number
EYHC1212C125		GY2M0300F030N-GU
EYHC1616C135		GY2M0200D020N-GU
EYHC1010D125		GY2M0200D020N-GS
EYHC1212D125		GY2M0300F020N-GS
EYHC1616D160		GY2M0200D020N-GM
EYHC1212F125		GY2M0300F030N-GM
EYHC1616F160		GY2M0200D020R05-GM
EYHC1212L125		GY2M0200D020L05-GM
EYHC1616L160	GY2M0300F030R05-GM	
EYHC1212L125	GY2M0300F030L05-GM	







1. ○ = R/L

SPARE PARTS

Holder number	 Clamp screw	 Wrench
EYHC1212C125	TS406 (Clamp Torque: 3.5 Nm)	TKY15R
EYHC1616C135		
EYHC1010D125		
EYHC1212D125		
EYHC1616D160		
EYHC1212F125		
EYHC1616F160		

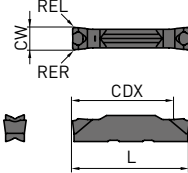
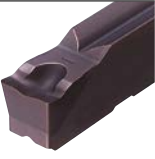
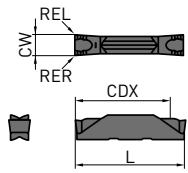
1. Wrench : z : Clamp screw
 2. ○ = R/L

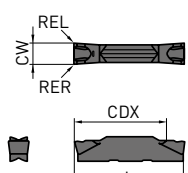
GY INSERTS

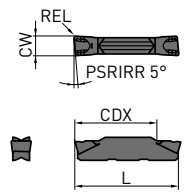
Order number	VP10RT	VP20RT	MY5015	MP9015	MP9025	NX2525	Seat size	Grooving width	Tolerance	RE	CDX	L	Geometry
FOR GROOVING/CUTTING OFF													
GY2M0200D020N-GU	●	●				●	D	2.00	±0.03	0.2	19.7	20.70	GU Breaker (For gummy steel)  
GY2M0239E020N-GU	●	●				●	E	2.39	±0.03	0.2	19.8	20.70	
GY2M0250E020N-GU	●	●				●	E	2.50	±0.03	0.2	19.5	20.70	
GY2M0300F030N-GU	●	●				●	F	3.00	±0.03	0.3	19.3	20.70	
GY2M0318F030N-GU	●	●				●	F	3.18	±0.03	0.3	19.3	20.70	
FOR CUTTING OFF													
GY2M0150C010N-GS	●	●				●	C	1.50	±0.03	0.1	13.4	14.70	GS Breaker (Low feeds)  
GY2M0200D020N-GS	●	●				●	D	2.00	±0.03	0.2	18.7	20.70	
GY2M0239E020N-GS	●	●				●	E	2.39	±0.03	0.2	18.5	20.70	
GY2M0250E020N-GS	●	●				●	E	2.50	±0.03	0.2	18.5	20.70	
GY2M0300F020N-GS	●	●				●	F	3.00	±0.03	0.2	18.5	20.70	
GY2M0318F020N-GS	●	●				●	F	3.18	±0.03	0.2	18.5	20.70	
GY2M0150C020N-GM	●	●	●	●	●	●	C	1.50	±0.03	0.2	13.9	14.70	GM Breaker (Medium feeds)  
GY2M0200D020N-GM	●	●	●	●	●	●	D	2.00	±0.03	0.2	19.4	20.70	
GY2M0239E020N-GM	●	●	●	●	●	●	E	2.39	±0.03	0.2	19.4	20.70	
GY2M0250E020N-GM	●	●	●	●	●	●	E	2.50	±0.03	0.2	19.4	20.70	
GY2M0300F030N-GM	●	●	●	●	●	●	F	3.00	±0.03	0.3	19.4	20.70	
GY2M0318F030N-GM	●	●	●	●	●	●	F	3.18	±0.03	0.3	19.4	20.70	
FOR CUTTING OFF													
GY2M0200D020R05-GM	●	●					D	2.00	±0.03	0.2	19.5	20.80	R/L05-GM Breaker  
GY2M0200D020L05-GM	●	●					D	2.00	±0.03	0.2	19.5	20.80	
GY2M0250E020R05-GM	●	●					E	2.50	±0.03	0.2	19.5	20.825	
GY2M0250E020L05-GM	●	●					E	2.50	±0.03	0.2	19.5	20.825	
GY2M0300F030R05-GM	●	●					F	3.00	±0.03	0.3	19.5	20.85	
GY2M0300F030L05-GM	●	●					F	3.00	±0.03	0.3	19.5	20.85	

Right hand insert shown.

1. When using insert widths 2.39 mm and 2.50 mm with E type seat sizes, in F type holders, the centre height will differ.

MINI-EY

RECOMMENDED CUTTING CONDITIONS

Material	Hardness	Grade	Vc	
P	Mild steel	VP20RT	165 (100-220)	
		VP10RT	170 (110-230)	
		MY5015	220 (140-300)	
		NX2525	150 (90-210)	
	Carbon steel Alloy steel	160-280 HB	VP20RT	130 (80-180)
			VP10RT	140 (90-190)
			MY5015	180 (110-250)
			NX2525	120 (70-170)
		>280 HB	VP20RT	100 (60-140)
			VP10RT	110 (70-150)
			MY5015	100 (90-210)
			NX2525	95 (55-135)
M	Stainless steel	<270 HB	VP20RT	100 (60-140)
		VP10RT	110 (70-150)	
K	Gray cast iron	Tensile Strength <300 MPa	VP20RT	130 (80-180)
		VP10RT	280 (90-190)	
		MY5015	220 (140-300)	
	Ductile cast iron	Tensile Strength <800 MPa	VP20RT	100 (60-140)
		VP10RT	110 (70-150)	
		MY5015	100 (90-210)	
S	Heat resistant alloy Titanium alloy	VP20RT	45 (30- 60)	
		VP10RT	55 (40- 70)	
		MP9015	70 (40-100)	
		MP9025	60 (30- 90)	

1. VP20RT is the first recommended grade for materials other than hardened steel.
2. For VP10RT, VP20RT and MY5015, wet cutting is recommended.

MINI-EY

RECOMMENDED CUTTING CONDITIONS

GU Breaker

Grooving, Cutting off

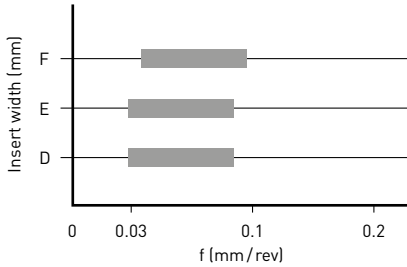

GS Breaker

Grooving, Cutting off

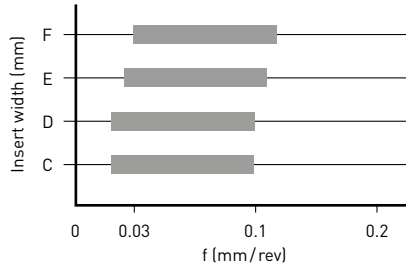

GM Breaker

Grooving, Cutting off

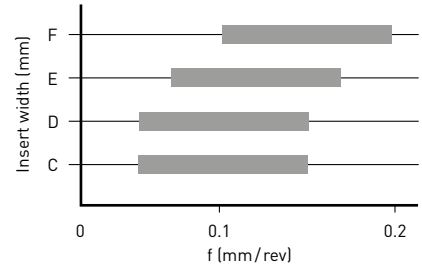

■ : 1st recommended area

Seat size	C	D	E	F
Insert width (mm)	1.50	2.00	2.39	3.00
	—	2.24	2.50	3.18
	—	—	2.74	3.24

APPLICATION EXAMPLE

Material	1.4021
Tool	GY2G0300F020N-MF VP20RT
Vc (m/min)	160
f (mm/rev)	0.22
Cutting mode	Semi finishing
Coolant	Internal coolant
Machine	Multi spindle machine MS32

Results Tool life was doubled compared to the conventional tool.

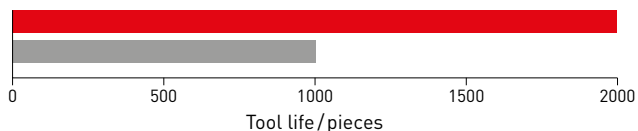

Material	1.4021
Tool	GY2G0300F020N-MF VP20RT
Vc (m/min)	160
f (mm/rev)	0.18 / 0.07
Cutting mode	Finish cutting
Coolant	Internal coolant
Machine	Multi spindle machine MS32

Results Tool life was 4 times longer than the conventional tool.

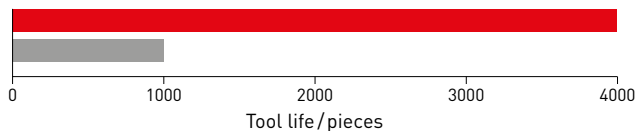

Material	1.4305
Tool	GY2M0200D020N-GM VP20RT
Vc (m/min)	160
f (mm/rev)	0.08 / 0.04
Cutting mode	Cutting off
Coolant	Internal coolant
Machine	Swiss Type Machine

Results Tool life was doubled compared to the conventional tool.

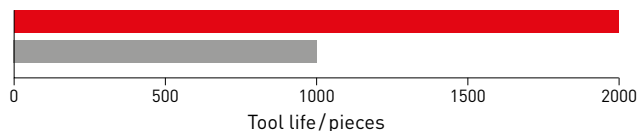

Material	1.4305
Tool	GY2M0200D020N-GM VP20RT
Vc (m/min)	120
f (mm/rev)	0.08 / 0.04
Cutting mode	Cutting off
Coolant	Internal coolant
Machine	Swiss type machine

Results Tool life was doubled compared to the conventional tool.

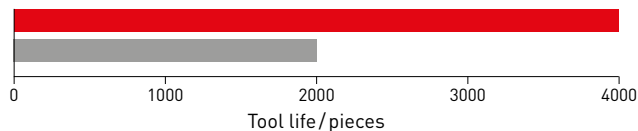

ARM

MULTI-FUNCTIONAL HIGH FEED CUTTER
FOR MOULD & DIE MACHINING



Mplus...

ARM

MULTI-FUNCTIONAL HIGH FEED CUTTER FOR MOULD & DIE MACHINING

ARM is a multifunctional high-performance cutter that provides process stability even at high feed rates. Its individual design as well as the advanced technical features promise high material removal rates combined with effective chip control.



PRODUCT RANGE

ARM07:

- Arbor type: DC Ø 40 mm
- Shank type: DC Ø 16 – 32 mm
- Weldon type: DC Ø 16 – 32 mm
- Screw in type: DC Ø 16 – 42 mm

ARM09:

- Arbor type: DC Ø 40 – 66 mm
- Shank type: DC Ø 25 – 35 mm
- Weldon type: DC Ø 25 – 32 mm
- Screw in type: DC Ø 25 – 42 mm

ARM11:

- Arbor type: DC Ø 50 – 80 mm
- Shank type: DC Ø 32 mm
- Screw in type: DC Ø 32 – 35 mm

APPLICATION

- Mould & die machining
- Roughing
- High feed cutting
- Face milling
- Copying
- Helical milling
- Pocketing





IDEAL FOR DEEP CAVITIES

- Internal coolant holes for air blow increases reliability due to effective chip disposal
- Ideal for high volume machining

HIGH PRODUCTIVITY FOR ROUGHING APPLICATIONS

- Time saving when machining high hardness plastic injection moulds and forging dies
- Ideal for high feed machining path strategies

COST EFFICIENT SOLUTION

- Economical 4 cutting edges
- Reinforced cutting edge geometry
- Versatile VP15TF grade for varied applications
- The micro-grain substrate and Miracle coating provide excellent welding resistance



BENEFITS

- High metal removal rates
- Near nett shape material remaining
- Process stability and security
- High rigidity for high feed rates
- Long tool life in both soft and hard materials
- Economic cost/performance ratio due to 4 cutting edges
- For high volume roughing
- Proven performance for machining of plastic injection moulds
- Versatile range of cutters available



ARM

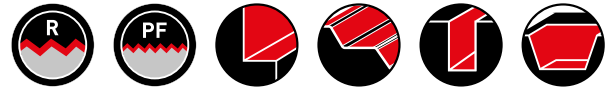

HIGH FEED MILLING CUTTER FOR MOULD & DIE

P M K H

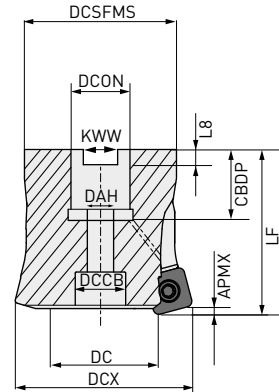

Right hand tool holder only.

ARBOR TYPE

Order number	Stock	CICT	DCX	DC	LF	DCON	CBDP	DAH	DCSFMS	KWW	L8	APMX	DCCB	Inserts
ARM07-040A07R	●	7	40	27.9	40	16	18	9	38.5	8.4	5.6	1.2	12	SPMX073505
ARM09-040A05R	●	5	40	22.9	40	16	18	9	38.5	8.4	5.6	1.4	12	SPMX094506
ARM09-042A05R	●	5	42	24.9	40	16	18	9	38.5	8.4	5.6	1.4	12	
ARM09-050A06R	●	6	50	33	40	22	20	11	49	10.4	6.3	1.4	17	
ARM09-052A07R	●	7	52	35	40	22	20	11	49	10.4	6.3	1.4	17	SPMX115506
ARM09-066A08R	●	8	66	48.9	50	27	22	13	60	12.4	7	1.4	19	
ARM11-050A05R	●	5	50	29.4	40	22	20	11	49	10.4	6.3	1.8	17	
ARM11-052A05R	●	5	52	31.4	40	22	20	11	49	10.4	6.3	1.8	17	SPMX115506
ARM11-063A06R	●	6	63	42.4	50	27	22	13	60	12.4	7	1.8	19	
ARM11-066A07R	●	7	66	45.4	50	27	22	13	60	12.4	7	1.8	19	
ARM11-080A08R	●	8	80	59.3	50	27	22	13	64	12.4	7	1.8	19	

25

SET BOLT

DCX	Set bolt	Geometry
∅ 40-42	M8-C	
∅ 50-52	M10-C	
∅ 63-80	M12-C	

ARM

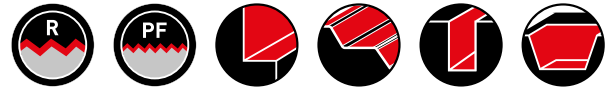

HIGH FEED MILLING CUTTER FOR MOULD & DIE

P M K H

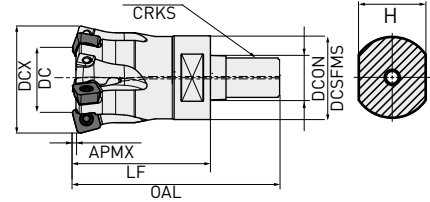

Right hand tool holder only.

SCREW-IN TYPE

Order number	Stock	CICT	DCX	DC	LF	DCON	DCSFMS	OAL	H	CRKS	APMX	Inserts
ARM07R162AM08	●	2	16	4	23	8.5	14	40	12	M8	0.6	SPMX073505
ARM07R203AM10	●	3	20	7.5	30	10.5	18	48	15	M10	1.2	
ARM07R254AM12	●	4	25	12.5	35	12.5	21	56	19	M12	1.2	
ARM07R325AM16	●	5	32	19.5	43	17	29	66	22	M16	1.2	
ARM07R356AM16	●	6	35	22.9	43	17	29	66	22	M16	1.2	
ARM07R427AM16	●	7	42	29.9	43	17	29	66	22	M16	1.2	
ARM09R252AM12	●	2	25	8	35	12.5	21	56	19	M12	1.4	SPMX094506
ARM09R324AM16	●	4	32	15	43	17	29	66	22	M16	1.4	
ARM09R354AM16	●	4	35	17.9	43	17	29	66	22	M16	1.4	
ARM09R425AM16	●	5	42	24.9	43	17	29	66	22	M16	1.4	SPMX115506
ARM11R323AM16	●	3	32	11.7	43	17	29	66	22	M16	1.8	
ARM11R353AM16	●	3	35	14.6	43	17	29	66	22	M16	1.8	

ARM

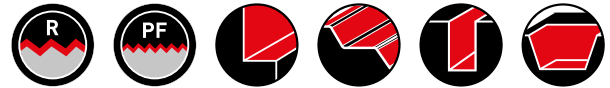

HIGH FEED MILLING CUTTER FOR MOULD & DIE

P M K H

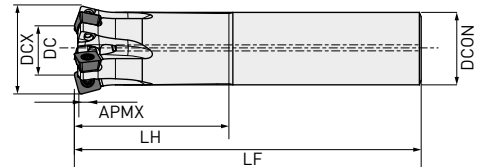

CYLINDRICAL SHANK

Order number	Stock	CICT	DCX	DCON	DC	LF	LH	APMX	Inserts
ARM07R162SA16S	●	2	16	16	4	85	25	0.6	
ARM07R162SA20S	●	2	16	20	4	130	30	0.6	
ARM07R203SA20S	●	3	20	20	7.5	130	30	1.2	SPMX073505
ARM07R254SA25S	●	4	25	25	12.5	140	40	1.2	
ARM07R325SA32S	●	5	32	32	19.5	150	50	1.2	
ARM09R252SA25S	●	2	25	25	8	140	40	1.4	
ARM09R252SA25L	●	2	25	25	8	200	40	1.4	
ARM09R324SA32S	●	4	32	32	15	150	50	1.4	SPMX094506
ARM09R324SA32L	●	4	32	32	15	200	50	1.4	
ARM09R354SA32S	●	4	35	32	17.9	150	50	1.4	
ARM11R323SA32S	●	3	32	32	11.7	150	50	1.8	SPMX115506

ARM

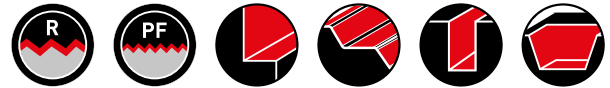

HIGH FEED MILLING CUTTER FOR MOULD & DIE

P M K H

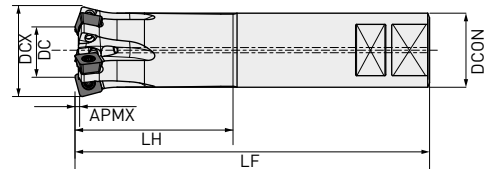

WELDON SHANK

Order number	Stock	CICT	DCX	DCON	DC	LF	LH	APMX	Inserts
ARM07R162WA16S	●	2	16	16	4	85	25	0.6	
ARM07R162WA20S	●	2	16	16	4	130	30	0.6	
ARM07R203WA20S	●	3	20	20	7.5	130	30	1.2	SPMX073505
ARM07R254WA25S	●	4	25	25	12.5	140	40	1.2	
ARM07R325WA32S	●	5	32	32	19.5	150	50	1.2	
ARM09R252WA25S	●	2	25	25	8	140	40	1.4	
ARM09R324WA32S	●	4	32	32	15	150	50	1.4	SPMX094506

INSERTS

Order number	Class	Honing*	VP15TF	VP10H	IC	S	RE	Shape
SPMX073505ZNEN-FT	M	E	●	●	7.0	3.5	0.5	
SPMX073505ZNSN-FT	M	S	●	●	7.0	3.5	0.5	
SPMX094506ZNEN-FT	M	E	●	●	9.7	4.4	0.6	
SPMX094506ZNSN-FT	M	S	●	●	9.7	4.4	0.6	
SPMX115506ZNEN-FT	M	E	●	●	11.6	5.4	0.6	
SPMX115506ZNSN-FT	M	S	●	●	11.6	5.4	0.6	

* Honing:
E: Round,
S: Chamfer + Hone

SPARE PARTS

Insert type		
	Clamp screw	Wrench
SPMX073505	TPS3	TIP10W
SPMX094506	TPS4C	TIP15W -C
SPMX115506	TPS43C	TIP15W -C

ARM

RECOMMENDED CUTTING CONDITIONS

Material	Hardness	Insert	Grade	Standard milling				High feed milling					
				Vc	fz	ap	ae	Vc	fz	ap	ae		
P Mild steel	<180HB	SPMX073505	VP15TF	170 (120-220)	1.0	0.3/0.8	100%/DC	200	1.0	0.4	100%/DC		
		SPMX094506			1.2	0.5/1	100%/DC		1.4	0.5	100%/DC		
		SPMX115506			1.5	0.8/1.5	100%/DC		1.4	0.8	100%/DC		
	Carbon steel, Alloy steel	180-280HB	SPMX073505	VP15TF	150 (100-200)	0.9	0.3/0.5	100%/DC	200			100%/DC	
			SPMX094506			1	0.5/0.7	100%/DC		1.2	0.5	100%/DC	
			SPMX115506			1.2	0.6/1.5	100%/DC		1.2	0.8	100%/DC	
Alloy tool steel	<350HB	SPMX073505	VP15TF	120 (80-140)	0.9	0.3/0.5	100%/DC	180	0.9	0.3	100%/DC		
		SPMX094506			1	0.5/0.7	100%/DC		0.8	0.4	100%/DC		
		SPMX115506			1	0.5/1	100%/DC		0.8	0.6	100%/DC		
Pre-hardened steel	35-45HRC	SPMX073505	VP15TF	100 (70-130)	0.75	0.25/0.4	100%/DC	150	0.75	0.3	100%/DC		
		SPMX094506			0.8	0.4/0.6	100%/DC		0.8	0.4	100%/DC		
		SPMX115506			0.8	0.4/0.8	100%/DC		0.8	0.5	100%/DC		
	Stainless steel	<200HB	SPMX073505	VP15TF	100 (60-120)	0.75	0.25/0.4	100%/DC	150	0.75	0.3	100%/DC	
			SPMX094506			0.8	0.4/0.6	100%/DC		0.8	0.4	100%/DC	
			SPMX115506			0.8	0.4/0.8	100%/DC		0.8	0.5	100%/DC	
M PH, Duplex	>200HB	SPMX073505	VP10H	120 (90-150)	0.8	0.4/0.6	100%/DC	150	0.8	0.4	100%/DC		
		SPMX094506			0.8	0.4/0.8	100%/DC		0.8	0.5	100%/DC		
		SPMX073505											
		SPMX094506											
K Gray cast iron	<200HB	SPMX073505	VP15TF	100 (60-120)	0.3	0.4/0.8	100%/DC	-	-	-	-		
		SPMX094506			0.4	0.5/1	100%/DC		-	-	-		
		SPMX115506			0.4	0.6/1.5	100%/DC		-	-	-		
		SPMX073505			0.3	0.25/0.4	100%/DC		-	-	-		
Ductile cast iron	<450MPa	SPMX094506	VP15TF	70 (50- 90)	0.4	0.3/0.5	100%/DC	-	-	-	-		
		SPMX115506			0.4	0.4/0.8	100%/DC		-	-	-		
		SPMX073505											
		SPMX094506											
H Hardened steel	40-55HRC	SPMX073505	VP15TF	120 (80-160)	1.0	0.3/0.6	100%/DC	-	-	-	-		
		SPMX094506			1.2	0.5/0.8	100%/DC		-	-	-		
		SPMX115506			1.2	0.6/1.5	100%/DC		-	-	-		
		Hardened steel	40-55HRC	SPMX073505	VP15TF	70 (50- 90)	0.8	0.25/0.5	100%/DC	120	-	-	-
				SPMX094506			1	0.4/0.6	100%/DC		0.5	0.25	100%/DC
				SPMX115506			1	0.5/0.8	100%/DC		0.6	0.3	100%/DC
Hardened steel	40-55HRC	SPMX073505	VP10H	90 (70-120)	0.6	0.3/0.5	100%/DC	120	0.5	0.25	100%/DC		
		SPMX094506			0.6	0.3/0.6	100%/DC		0.6	0.3	100%/DC		
		SPMX115506			0.6	0.3/0.6	100%/DC		0.6	0.4	100%/DC		

NOTE FOR PROGRAMMING

When using ARM cutters, please program as an RE radius cutter.
The approximate uncut portions for the program are as follows:

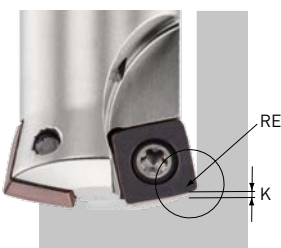

Insert size	RE	K
07	1.7	0.82
09	2.3	1.6
11	2.695	2.1

SIDE AND FACE MILLING CUTTER SERIES

SIDE AND FACE MACHINING WITH LOW CUTTING
RESISTANCE VERTICAL MOUNT DOUBLE-SIDED INSERTS
FOR DCV SERIES

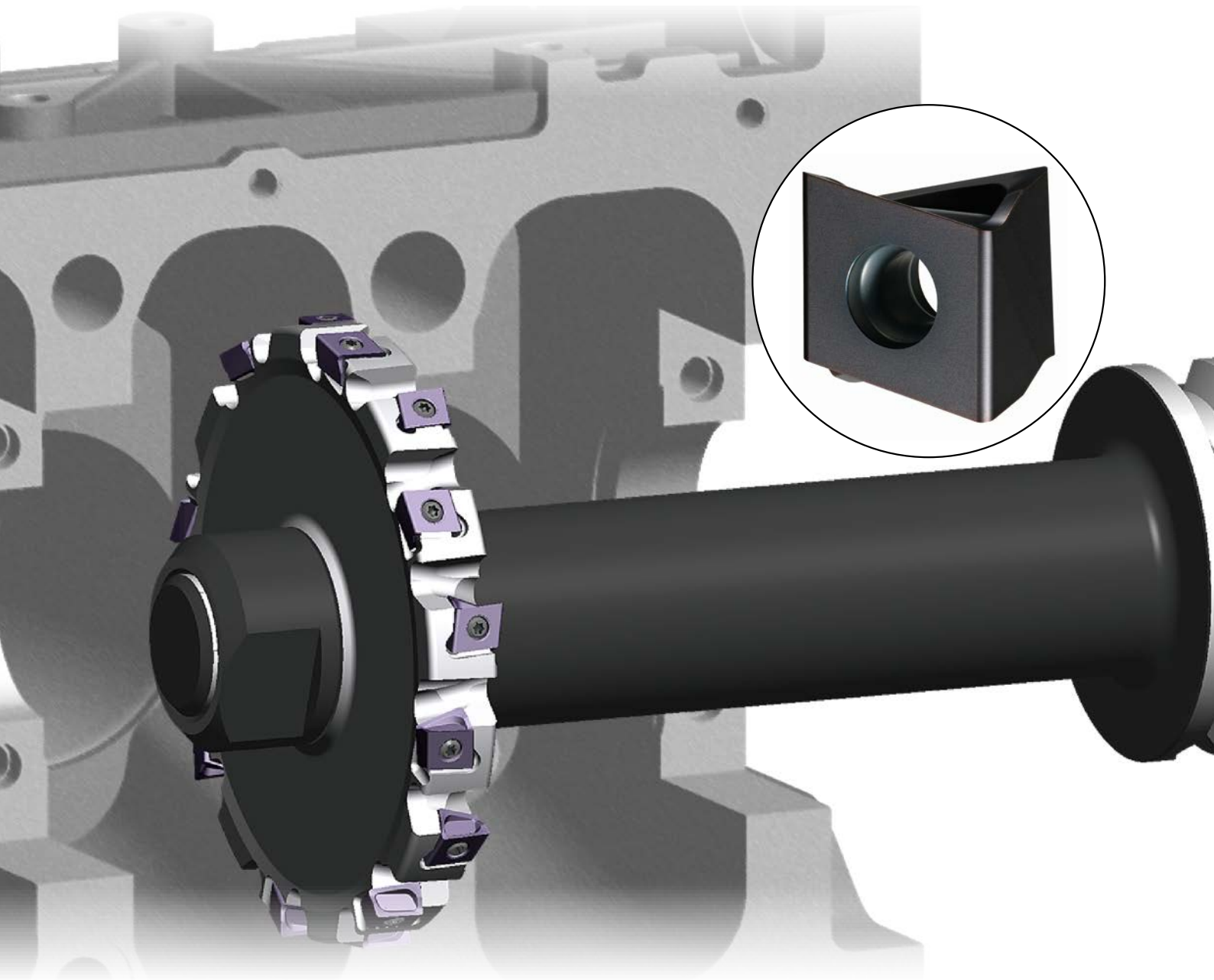

*M*plus...

DCV3 / DCV4 / DCV5

EXCHANGEABLE INSERTS

ECONOMICAL INSERT DESIGN

Tangential type insert with 4 cutting edges.

SECURE CLAMPING

Special seating surfaces ensure all different insert radius sizes are securely clamped.

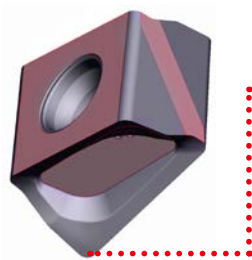

Corner radius R 0.4 mm

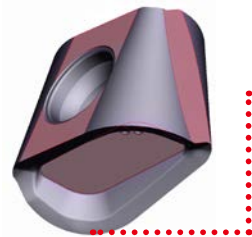

NEW Corner radius R 4.0 mm for DCV3
Corner radius R 5.0 mm for DCV4
Corner radius R 7.0 mm for DCV5

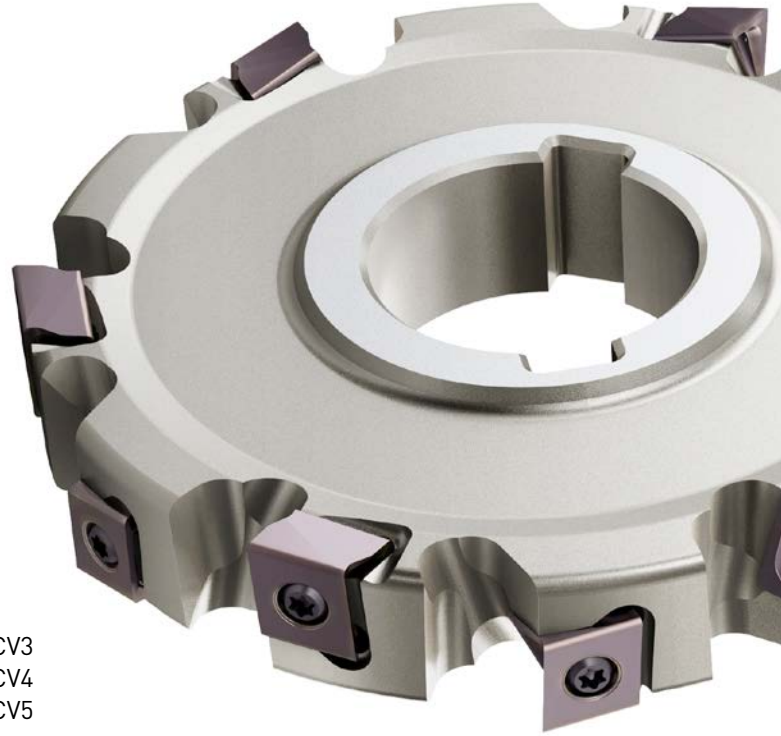

Cutter body with inserts : GAMF : + 8° GAMP : + 3°

LOW CUTTING RESISTANCE INSERT → PREFERRED SHARPNESS

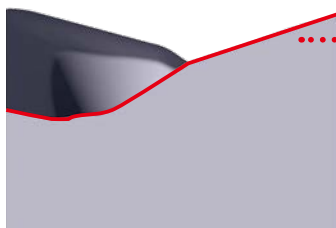

Tough cutting edge
(Convex curve)

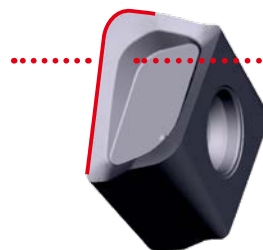

Double-phased helical
rake angles

HIGH PRECISION CORNER RADIUS

PRECISION INSERTS FOR FORMING ACCURATE CORNER RADII IN THE WORKPIECE.

R 0.4 – R 3.0 mm

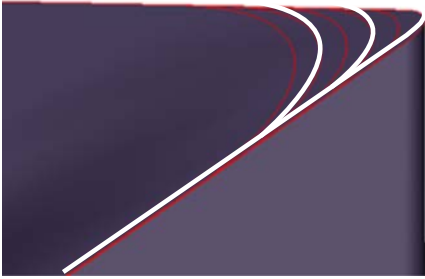

R 3.0 – R 7.0 mm

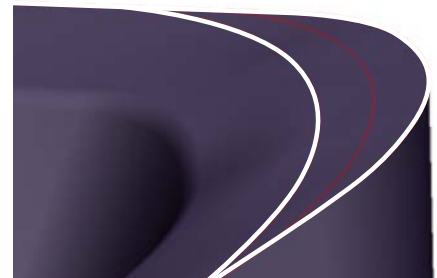

CONSISTENT GEOMETRY

Cutting width and diameter do not change even when different corner radius inserts are used.

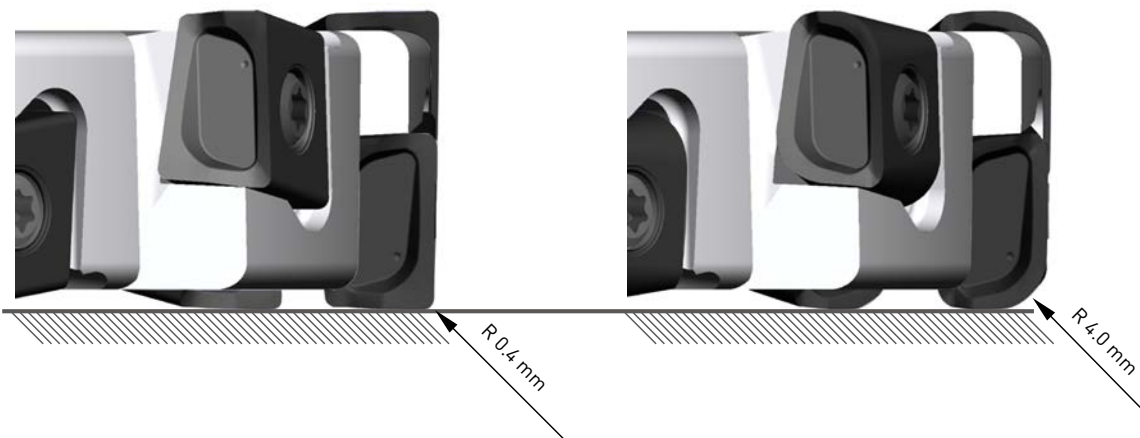

LARGE VARIETY OF CORNER RADII AVAILABLE

NEW

DCV3 = R 0.4 – R 4.0 mm

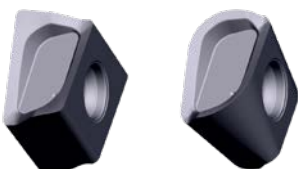

DCV4 = R 0.4 – R 5.0 mm

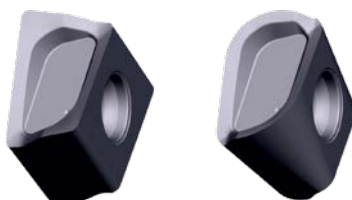

DCV5 = R 0.4 – R 7.0 mm

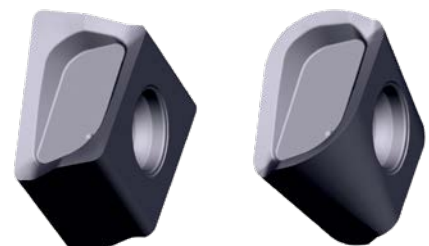

NEW*Mplus...*

DCV3

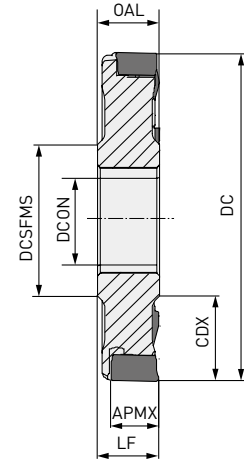
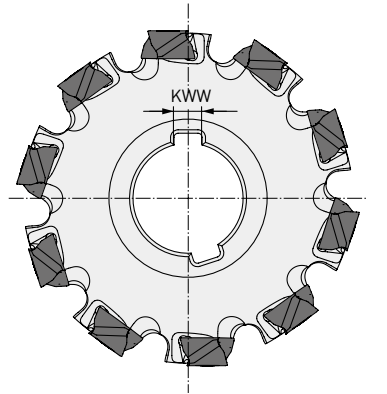
**P** **K**

Max. APMX: 8.6 mm

HALF SIDE

DC	ZNF	LF = OAL	CDX	DCON	DCSFMS	KWW	
80 - 99.9	8		20.0	27	40	7	
100 - 124.9	10	≥12	27.0	32	46	8	LNGU09
125 - 160.0	12		35.0	40	55	10	

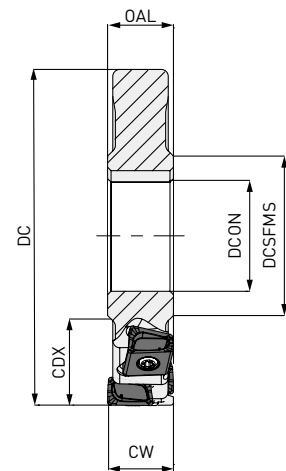
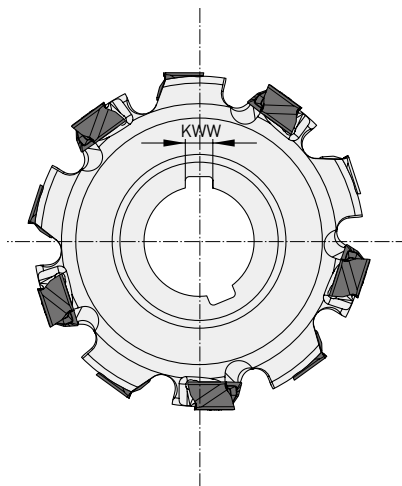
40 

Largest width CW: 17.2 mm

FULL SIDE

DC	ZNF	ZNP	LF = OAL	CW	CDX	DCON	DCSFMS	KWW	
80 - 99.9	4	8		12-17.2	20.0	27	40	7	
100 - 124.9	5	10	≥12	12-17.2	27.0	32	46	8	LNGU09
125 - 160.0	6	12		12-17.2	35.0	40	55	10	

1. Multi level designs available for each size. Please contact our technical department (MMC Hartmetall GmbH - special@mmchg.de) for details of any geometry not shown.

40 

NEW

DCV3



P K

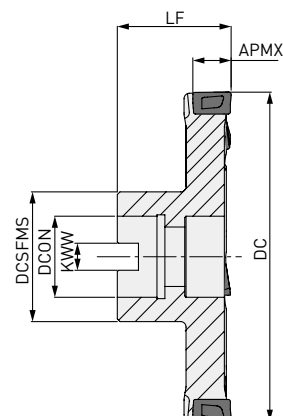
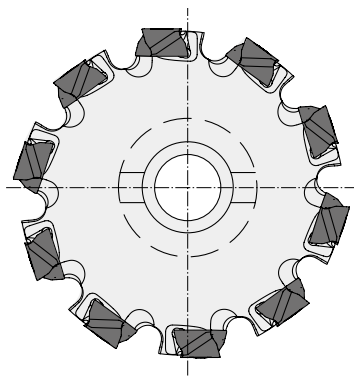

Max. APMX: 8.6 mm

HALF SIDE ARBOR

DC	ZEFP	LF	CDX	DCON	DCSFMS	KWW	
80 - 99.9	8	50	20.0	27	40	12.4	LNGU09
100 - 124.9	10	60	27.0	32	46	14.4	
125 - 160.0	12	60	35.0	40	55	16.4	

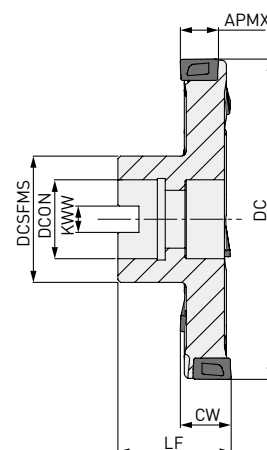
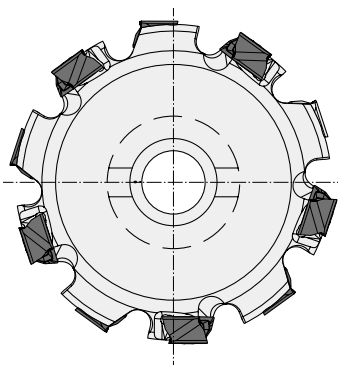
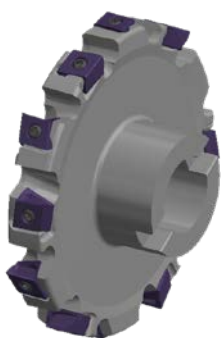

Largest width CW: 17.2 mm

FULL SIDE ARBOR



DC	ZEFP	LF	CW	CDX	DCON	DCSFMS	KWW	
80 - 99.9	8	50	12-17.2	20.0	27	40	12.4	LNGU09
100 - 124.9	10	60	12-17.2	27.0	32	46	14.4	
125 - 160.0	12	60	12-17.2	35.0	40	55	16.4	

1. Multi level designs available for each size. Please contact our technical department (MMC Hartmetall GmbH - special@mmchg.de) for details of any geometry not shown.



DCV3

SPARE PARTS

Tool holder type		TQ (Nm)		
	Clamp screw	Clamp torque	Wrench	Anti-seize lubricant
DCV3 LNGU09060PNEOM	TS304	1.5	TKY08W	MK1KS

INSERT

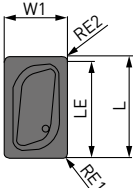
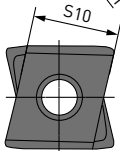
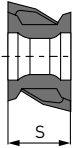
Order number	VP15TF	Hand	Class	Honing	L	LE	S	S10	RE1	W1	Shape	Geometry
NEW LNGU090604PNER-M	●	R	G	E	9	8.6	6	8.5	0.4	6		
NEW LNGU090608PNER-M	●	R	G	E	9	8.6	6	8.5	0.8	6		
NEW LNGU090612PNER-M	●	R	G	E	9	8.6	6	8.5	1.2	6		
NEW LNGU090616PNER-M	●	R	G	E	9	8.6	6	8.5	1.6	6		
NEW LNGU090620PNER-M	●	R	G	E	9	8.6	6	8.5	2	6		
NEW LNGU090624PNER-M	●	R	G	E	9	8.6	6	8.5	2.4	6		
NEW LNGU090630PNER-M	●	R	G	E	9	8.6	6	8.5	3	6		
NEW LNGU090640PNER-M	●	R	G	E	9	8.6	6	8.5	4	6		
NEW LNGU090604PNEL-M	●	L	G	E	9	8.6	6	8.5	0.4	6		
NEW LNGU090608PNEL-M	●	L	G	E	9	8.6	6	8.5	0.8	6		
NEW LNGU090612PNEL-M	●	L	G	E	9	8.6	6	8.5	1.2	6		
NEW LNGU090616PNEL-M	●	L	G	E	9	8.6	6	8.5	1.6	6		
NEW LNGU090620PNEL-M	●	L	G	E	9	8.6	6	8.5	2	6		
NEW LNGU090624PNEL-M	●	L	G	E	9	8.6	6	8.5	2.4	6		
NEW LNGU090630PNEL-M	●	L	G	E	9	8.6	6	8.5	3	6		
NEW LNGU090640PNEL-M	●	L	G	E	9	8.6	6	8.5	4	6		

[10 inserts in one case]

DCV4



P K

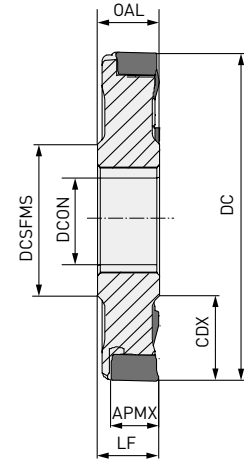
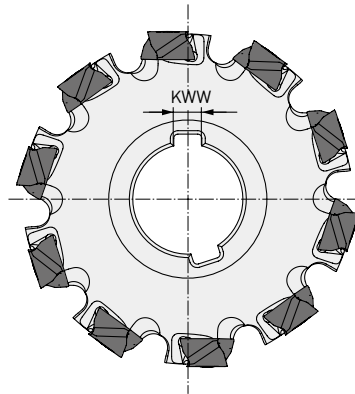
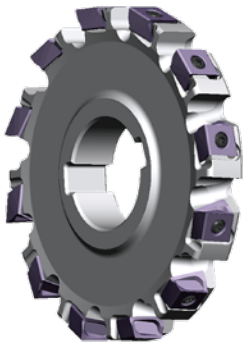

Max. APMX: RE1 < 3.0 mm 12.2 mm
RE1 > 3.0 mm 11.4 mm

HALF SIDE

DC	ZEFP	LF = OAL	CDX	DCON	DCSFMS	KWW	
80 - 99.9	8	18	20.0	27	40	7	LNGU13
100 - 124.9	10		27.0	32	46	8	
125 - 159.9	12		35.0	40	55	10	
160 - 200	14		52.5	40	55	10	

40 

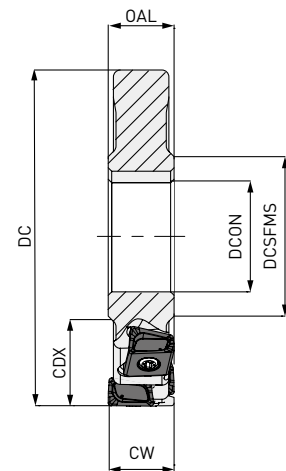
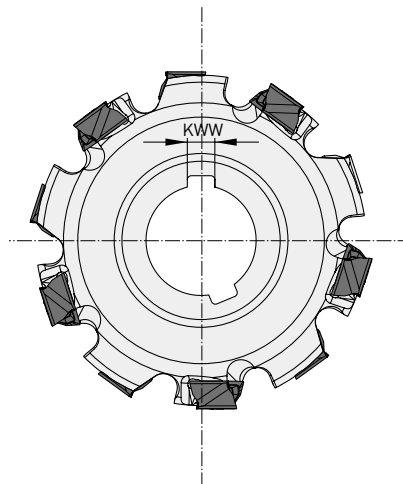

Largest width CW: 24 mm

FULL SIDE

DC	ZEFP	CW	CDX	DCON	DCSFMS	KWW	
80 - 99.9	4	18-24	20.0	27	40	7	LNGU13
100 - 124.9	5	18-24	27.0	32	46	8	
125 - 159.9	6	18-24	35.0	40	55	10	
160 - 200	7	18-24	52.5	40	55	10	

1. Multi level designs available for each size. Please contact our technical department (MMC Hartmetall GmbH - special@mmchg.de) for details of any geometry not shown.

40 

DCV4



P K

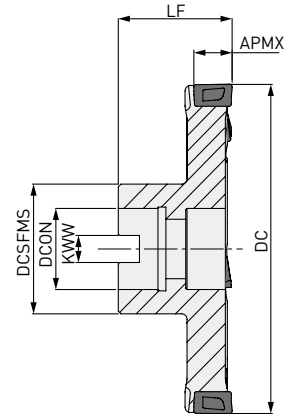
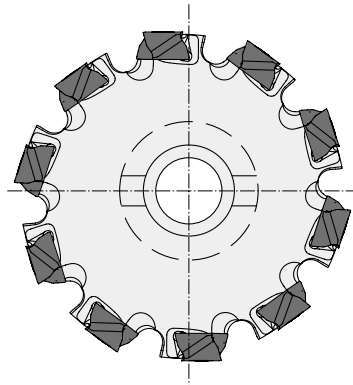
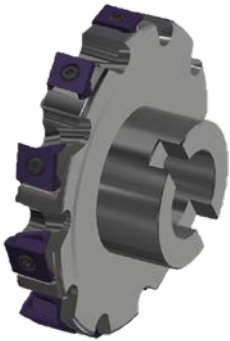

Max. APMX: RE1 < 3.0 mm 12.2 mm
RE1 > 3.0 mm 11.4 mm

HALF SIDE ARBOR

DC	ZEFP	LF	CDX	DCON	DCSFMS	KWW	
80 - 99.9	8 - 10	50	20	27	40	12.4	LNGU13
100 - 124.9	10 - 12	60	27	32	46	14.4	
125 - 159.9	12 - 14	60	35	40	55	16.4	
160 - 200	14 - 20	70	52.5	40	55	16.4	

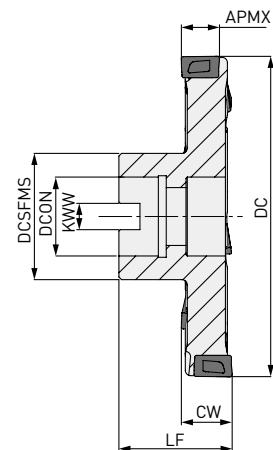
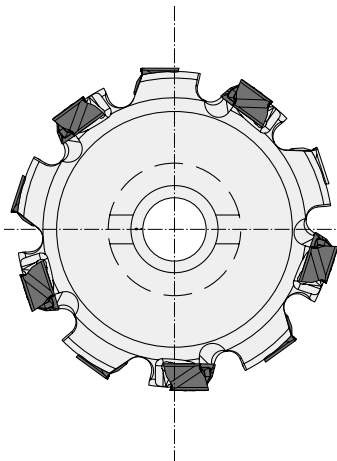

40 

Largest width CW: 24 mm

FULL SIDE ARBOR



DC	ZEFP	LF	CW	CDX	DCON	DCSFMS	KWW	
80 - 99.9	8 - 10	50	18-24	20	27	40	12.4	LNGU13
100 - 124.9	10 - 12	60	18-24	27	32	46	14.4	
125 - 159.9	12 - 14	60	18-24	35	40	55	16.4	
160 - 200	14 - 20	70	18-24	52.5	40	55	16.4	

1. Multi level designs available for each size. Please contact our technical department (MMC Hartmetall GmbH - special@mmchg.de) for details of any geometry not shown.

40 

DCV4

SPARE PARTS

Tool holder type		TQ (Nm)		
	Clamp screw	Clamp torque	Wrench	Anti-seize lubricant
DCV4 LNGU13080PNE	TS406	3.5	TKY15T	MK1KS

INSERT

Order number	MP6120	VP15TF	Hand	Class	Honing	L	LE	S	S10	RE1	RE2	W1	Shape	Geometry
LNGU130804PNER-M	●		R	G	E	13.0	12.2	8.0	11.0	0.4	0.8	8.0		
LNGU130804PNEL-M	●		L	G	E	13.0	12.2	8.0	11.0	0.4	0.8	8.0		
LNGU130808PNER-M	●		R	G	E	13.0	12.2	8.0	11.0	0.8	0.8	8.0		
LNGU130808PNEL-M	●		L	G	E	13.0	12.2	8.0	11.0	0.8	0.8	8.0		
LNGU130812PNER-M	●		R	G	E	13.0	12.2	8.0	11.0	1.2	0.8	8.0		
LNGU130812PNEL-M	●		L	G	E	13.0	12.2	8.0	11.0	1.2	0.8	8.0		
LNGU130816PNER-M	●		R	G	E	13.0	12.2	8.0	11.0	1.6	0.8	8.0		
LNGU130816PNEL-M	●		L	G	E	13.0	12.2	8.0	11.0	1.6	0.8	8.0		
LNGU130820PNER-M	●		R	G	E	13.0	12.2	8.0	11.0	2.0	0.8	8.0		
LNGU130820PNEL-M	●		L	G	E	13.0	12.2	8.0	11.0	2.0	0.8	8.0		
LNGU130824PNER-M	●		R	G	E	13.0	12.2	8.0	11.0	2.4	0.8	8.0		
LNGU130824PNEL-M	●		L	G	E	13.0	12.2	8.0	11.0	2.4	0.8	8.0		
LNGU130830PNER-M	●		R	G	E	13.0	11.4	8.0	11.0	3.0	1.6	8.0		
LNGU130830PNEL-M	●		L	G	E	13.0	11.4	8.0	11.0	3.0	1.6	8.0		
LNGU130840PNER-M	●		R	G	E	13.0	11.4	8.0	11.0	4.0	1.6	8.0		
LNGU130840PNEL-M	●		L	G	E	13.0	11.4	8.0	11.0	4.0	1.6	8.0		
LNGU130850PNER-M	●		R	G	E	13.0	11.4	8.0	11.0	5.0	1.6	8.0		
LNGU130850PNEL-M	●		L	G	E	13.0	11.4	8.0	11.0	5.0	1.6	8.0		
LNGU130804PNER-R	●	●	R	G	E	13.0	12.2	8.0	11.0	0.4	0.8	8.0		
LNGU130804PNEL-R	●	●	L	G	E	13.0	12.2	8.0	11.0	0.4	0.8	8.0		
LNGU130808PNER-R	●	●	R	G	E	13.0	12.2	8.0	11.0	0.8	0.8	8.0		
LNGU130808PNEL-R	●	●	L	G	E	13.0	12.2	8.0	11.0	0.8	0.8	8.0		
LNGU130812PNER-R	●	●	R	G	E	13.0	12.2	8.0	11.0	1.2	0.8	8.0		
LNGU130812PNEL-R	●	●	L	G	E	13.0	12.2	8.0	11.0	1.2	0.8	8.0		
LNGU130816PNER-R	●	●	R	G	E	13.0	12.2	8.0	11.0	1.6	0.8	8.0		
LNGU130816PNEL-R	●	●	L	G	E	13.0	12.2	8.0	11.0	1.6	0.8	8.0		
LNGU130820PNER-R	●	●	R	G	E	13.0	12.2	8.0	11.0	2.0	0.8	8.0		
LNGU130820PNEL-R	●	●	L	G	E	13.0	12.2	8.0	11.0	2.0	0.8	8.0		
LNGU130824PNER-R	●	●	R	G	E	13.0	12.2	8.0	11.0	2.4	0.8	8.0		
LNGU130824PNEL-R	●	●	L	G	E	13.0	12.2	8.0	11.0	2.4	0.8	8.0		
LNGU130830PNER-R	●	●	R	G	E	13.0	11.4	8.0	11.0	3.0	1.6	8.0		
LNGU130830PNEL-R	●	●	L	G	E	13.0	11.4	8.0	11.0	3.0	1.6	8.0		
LNGU130840PNER-R	●	●	R	G	E	13.0	11.4	8.0	11.0	4.0	1.6	8.0		
LNGU130840PNEL-R	●	●	L	G	E	13.0	11.4	8.0	11.0	4.0	1.6	8.0		
LNGU130850PNER-R	●	●	R	G	E	13.0	11.4	8.0	11.0	5.0	1.6	8.0		
LNGU130850PNEL-R	●	●	L	G	E	13.0	11.4	8.0	11.0	5.0	1.6	8.0		

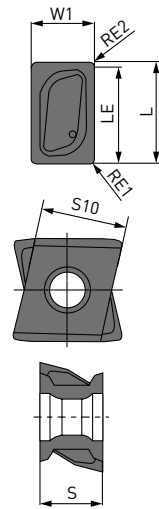

(10 inserts in one case)

DCV5



P K

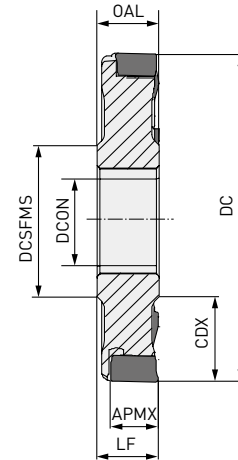
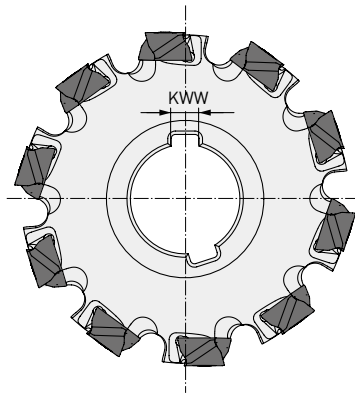

Max. APMX: RE1 < 3.0 mm 16.2 mm
RE1 > 3.0 mm 15.4 mm

HALF SIDE

DC	ZEFP	LF = OAL	CDX	DCON	DCSFMS	KWW	
100 - 124.9	8	23	27.0	32	46	8	LNGU17
125 - 159.9	10		35.0	40	55	10	
160 - 199.9	12		52.5	40	55	10	
200 - 250	16		65.0	50	70	12	

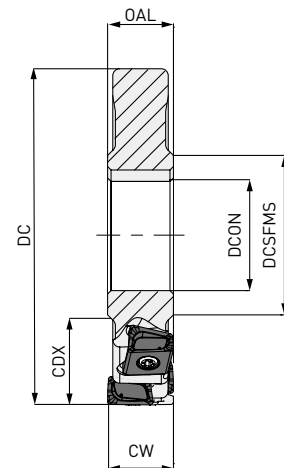
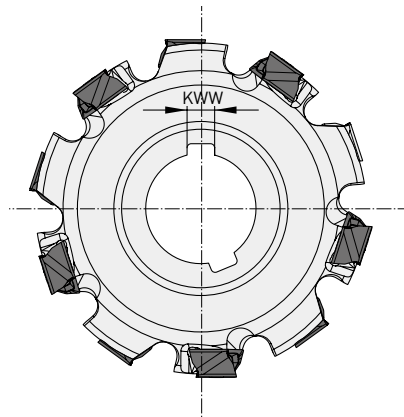

Largest width CW: 32 mm

FULL SIDE

DC	ZEFP	CW	CDX	DCON	DCSFMS	KWW	
100 - 124.9	8	23-32	27.0	32	46	8	LNGU17
125 - 159.9	10		35.0	40	55	10	
160 - 199.9	12		52.5	40	55	10	
200 - 250	16		65.0	50	70	12	

1. Multi level designs available for each size. Please contact our technical department (MMC Hartmetall GmbH - special@mmchg.de) for details of any geometry not shown.



DCV5



P K

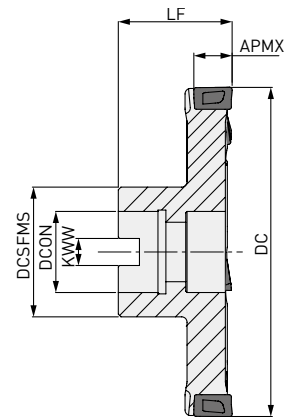
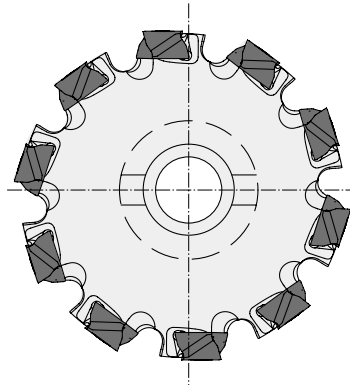

Max. APMX: RE1 < 3.0 mm 16.2 mm
RE1 > 3.0 mm 15.4 mm

HALF SIDE ARBOR

DC	ZEFP	LF	CDX	DCON	DCSFMS	KWW	
100 - 124.9	8 - 10	50	27	32	46	14.4	LNGU17
125 - 159.9	10 - 12	60	35	40	55	16.4	
160 - 199.9	12 - 14	60	52.5	40	55	16.4	
200 - 250	14 - 20	70	65	40	70	16.4	

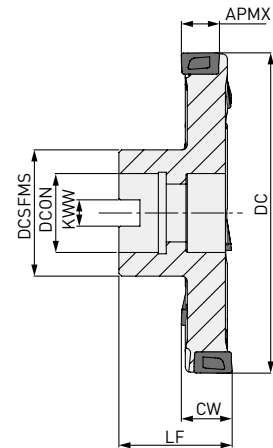
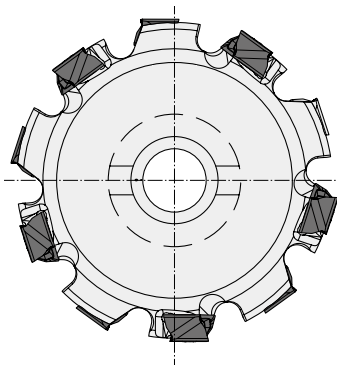
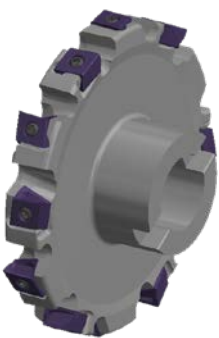

Largest width CW: 32 mm

FULL SIDE ARBOR



DC	ZEFP	LF	CW	CDX	DCON	DCSFMS	KWW	
100 - 124.9	8 - 10	60	23-32	27	32	46	14.4	LNGU17
125 - 159.9	10 - 12	60		35	40	55	16.4	
160 - 199.9	12 - 14	70		52.5	40	55	16.4	
200 - 250.0	14 - 20	70		65	40	70	16.4	

1. Multi level designs available for each size. Please contact our technical department (MMC Hartmetall GmbH - special@mmchg.de) for details of any geometry not shown.



DCV5

SPARE PARTS

Tool holder type		TQ (Nm)		
	Clamp screw	Clamp torque	Wrench	Anti-seize lubricant
DCV5 LNGU17100PNEOR	TS53	7.5	TKY25T	MK1KS

INSERT

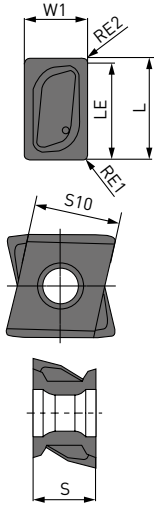
Order number	MP6120	VP15TF	Hand	Class	Honing	L	LE	S	S10	RE1	RE2	W1	D1	Shape	Geometry
LNGU171004PNER-R	●	●	R	G	E	17.0	16.2	10.0	13.0	0.4	0.8	10.0	5.5		
LNGU171004PNEL-R	●	●	L	G	E	17.0	16.2	10.0	13.0	0.4	0.8	10.0	5.5		
LNGU171008PNER-R	●	●	R	G	E	17.0	16.2	10.0	13.0	0.8	0.8	10.0	5.5		
LNGU171008PNEL-R	●	●	L	G	E	17.0	16.2	10.0	13.0	0.8	0.8	10.0	5.5		
LNGU171012PNER-R	●	●	R	G	E	17.0	16.2	10.0	13.0	1.2	0.8	10.0	5.5		
LNGU171012PNEL-R	●	●	L	G	E	17.0	16.2	10.0	13.0	1.2	0.8	10.0	5.5		
LNGU171016PNER-R	●	●	R	G	E	17.0	16.2	10.0	13.0	1.6	0.8	10.0	5.5		
LNGU171016PNEL-R	●	●	L	G	E	17.0	16.2	10.0	13.0	1.6	0.8	10.0	5.5		
LNGU171020PNER-R	●	●	R	G	E	17.0	16.2	10.0	13.0	2.0	0.8	10.0	5.5		
LNGU171020PNEL-R	●	●	L	G	E	17.0	16.2	10.0	13.0	2.0	0.8	10.0	5.5		
LNGU171024PNER-R	●	●	R	G	E	17.0	16.2	10.0	13.0	2.4	0.8	10.0	5.5		
LNGU171024PNEL-R	●	●	L	G	E	17.0	16.2	10.0	13.0	2.4	0.8	10.0	5.5		
LNGU171030PNER-R	●	●	R	G	E	17.0	15.4	10.0	13.0	3.0	1.6	10.0	5.5		
LNGU171030PNEL-R	●	●	L	G	E	17.0	15.4	10.0	13.0	3.0	1.6	10.0	5.5		
LNGU171040PNER-R	●	●	R	G	E	17.0	15.4	10.0	13.0	4.0	1.6	10.0	5.5		
LNGU171040PNEL-R	●	●	L	G	E	17.0	15.4	10.0	13.0	4.0	1.6	10.0	5.5		
LNGU171050PNER-R	●	●	R	G	E	17.0	15.4	10.0	13.0	5.0	1.6	10.0	5.5		
LNGU171050PNEL-R	●	●	L	G	E	17.0	15.4	10.0	13.0	5.0	1.6	10.0	5.5		
LNGU171060PNER-R	●	●	R	G	E	17.0	15.4	10.0	13.0	6.0	1.6	10.0	5.5		
LNGU171060PNEL-R	●	●	L	G	E	17.0	15.4	10.0	13.0	6.0	1.6	10.0	5.5		
LNGU171070PNER-R	●	●	R	G	E	17.0	15.4	10.0	13.0	7.0	1.6	10.0	5.5		
LNGU171070PNEL-R	●	●	L	G	E	17.0	15.4	10.0	13.0	7.0	1.6	10.0	5.5		

[10 inserts in one case]

APPLICATION EXAMPLES

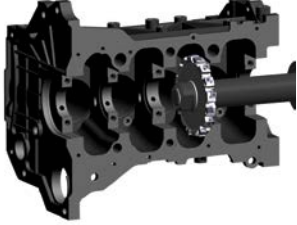
Tool	DCV4 Ø 300 mm	DCV4 Ø 160 mm
Insert (Grade)	LNGU130804PNER-M (VP15TF)	LNGU130804PNER-M (VP15TF)
	Brake caliper (DIN GGG40.3)	Cylinder block (DIN GG25)
Workpiece		
n (min ⁻¹)	120	500
Vc (m/min)	113	201
fz (mm/t.)	0.09-0.24	0.14
Vf (mm/min)	150-400	500
ap (mm)	1.0-2.0	1.0
Cutting Mode	Dry cutting	Dry cutting
Machine	Machining centre	Horizontal

Results	Approximately 2 x longer tool life than conventional products. Excellent dimensional accuracy and surface finish. Improved machining efficiency gave a 30 % reduction in tooling costs.	1.5 x better machining efficiency than conventional products. Approximately double tool life. Stable cutting with minimal sound and provided a good surface finish. Improved machining efficiency and longer tool life.
---------	---	---

1. The above application examples are customer's application examples, and can differ from the recommended conditions.

UNIQUE SIDE CUTTER SERIES

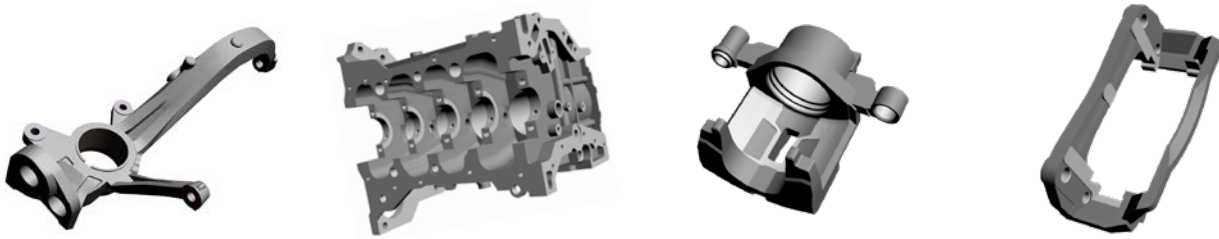

Taking advantage of the latest technology, materials and cutter geometry.

CLASSIFIED

	DCV3	DCV4	DCV5
Material	P K	P K	P K
Low cutting resistance	◎	◎	◎
Toughness	◎	◎	◎
Insert shape		Vertical	Vertical
ZNF		Double sided insert	Double sided insert
ZNP	4	4	4
Half side Max. depth of cut APMX	RE ≤ 4.0 mm 8.6 mm RE ≥ 3.0mm 11.4 mm	RE ≤ 3.0 mm 12.2 mm RE ≥ 3.0mm 11.4 mm	RE ≤ 3.0 mm 16.2 mm RE ≥ 3.0 mm 15.4 mm
Full side Max. cutting dia DC	Ø 300 mm	Ø 400 mm	Ø 660 mm

DCV3 / DCV4 / DCV5

RECOMMENDED CUTTING CONDITIONS

SHOULDER MILLING

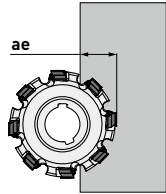
Material	Hardness	Grade	Vc	ap	ae	fz	Cutting mode
P Steel	≤180HB	MP6120 VP15TF	150 (130-180)	≤APMX	<10%	0.10 (0.08-0.15)	
					<30%		
					≤50%		
					≤2.0		
Carbon steel/ Alloy steel	180-280HB	MP6120 VP15TF	150 (130-180)	≤APMX	<10%	0.10 (0.08-0.15)	
					<30%		
					≤50%		
					≤2.0		
K Cast iron	Tensile strength ≤ 350MPa	VP15TF	150 (130-180)	≤APMX	<10%	0.10 (0.08-0.15)	
					<30%		
					≤50%		
					≤2.0		
Gray cast iron	Tensile strength ≤ 450MPa	VP15TF	130 (110-160)	≤APMX	<10%	0.10 (0.08-0.15)	
					<30%		
					≤50%		
					≤2.0		
Ductile cast iron	Tensile strength ≤ 800MPa	VP15TF	130 (110-160)	≤APMX	<10%	0.10 (0.08-0.15)	
					<30%		
					≤50%		
					≤2.0		

FACE MILLING

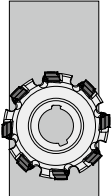
Material	Hardness	Grade	Vc	ap	fz	Cutting mode		
P Steel	≤180HB	MP6120 VP15TF	150 (130-180)	≤APMX	0.10 (0.08-0.15)			
							≤2.0	0.12 (0.08-0.20)
							≤4.0	0.10 (0.08-0.15)
Carbon steel/ Alloy steel	180-280HB	MP6120 VP15TF	150 (130-180)	≤APMX	<10%	0.10 (0.08-0.15)		
					<30%			
					≤50%			
K Cast iron	Tensile strength ≤ 350MPa	VP15TF	150 (130-180)	≤APMX	<10%	0.10 (0.08-0.15)		
					<30%			
					≤50%			
Gray cast iron	Tensile strength ≤ 450MPa	VP15TF	150 (130-180)	≤APMX	<10%	0.10 (0.08-0.15)		
					<30%			
					≤50%			
Ductile cast iron	Tensile strength ≤ 800MPa	VP15TF	130 (110-160)	≤APMX	<10%	0.10 (0.08-0.15)		
					<30%			
					≤50%			

LSE445/NSE300/400

GENERAL FACE MILLING SERIES WITH 20° POSITIVE
INSERTS FOR RELIABLE AND EFFICIENT MACHINING



*M*plus...

LSE445



45° FACE MILLING GENERAL CUTTING

P M K N



C H:45°
A.R:+19° T:+13°
RR:-2° I:+15°

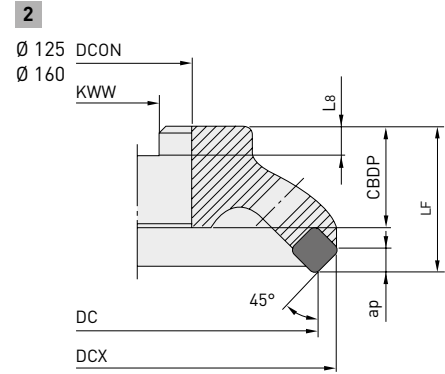
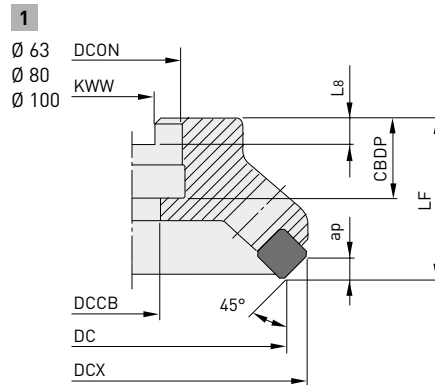

ARBOR TYPE

Order number	Stock		ZEFP	DC	DCX	LF	DCON	CBDP	DCCB	KWW	L8	WT	APMX	Type
	R	L												
	LSE445-063A05R/L-E	●												
LSE445-080A06R/L-E	●	□	6	80	93.5	50	27	22	13.5	12.4	7.0	1.0	5.5	1
LSE445-100A07R/L-E	●	□	7	100	113.5	50	32	25	17.5	14.4	8.0	1.4	5.5	1
LSE445-125B09R/L-E	□	□	9	125	138.5	50	40	32	—	16.4	9.0	2.0	5.5	2
LSE445-160B11R/L-E	□	□	11	160	173.5	50	40	32	—	16.4	9.0	3.0	5.5	2



SPARE PARTS

Tool holder number	Shim	Shim screw	Wedge	Clamp screw	Wrench	Wrench
LSE445 -063A05R/L-E				LS10T		
LSE445 -080A04R/L-E						
LSE445-100A07R/L-E	STBE445NF	CS300890T	CWSE445TR	LS15T	TKY25T	TKY08F
LSE445-125B09R/L-E						
LSE445 -160B11R/L-E						

*1 Clamp Torque (N • m) : LS10T=8.5. LS15T=8.5. CS300890T=1.0

LSE445

RECOMMENDED CUTTING CONDITIONS

Material	Hardness	Grade	Vc	fz
P Mild steel	<180HB	F7030	300 (200-360)	0.2 (0.1-0.3)
		NX4545		
		UTi20T	240 (170-300)	
		UP20M		
P Carbon steel Alloy steel	180-280HB	F7030	250 (170-300)	0.2 (0.1-0.3)
		NX4545		
		UTi20T	200 (140-240)	
		UP20M		
M Stainless steel	<200HB	UTi20T	140 (100-170)	0.15 (0.1-0.2)
		UP20M		
K Cast iron	Tensile Strength <450MPa	MC5020	200 (130-240)	0.2 (0.1-0.3)
		F5010		
		F5020	160 (110-190)	
		HTi10		
N Aluminium alloy	—	UTi20T	1000 (200-1500)	0.15 (0.05-0.25)
		MD220		
N Aluminium alloy	—	HTi10	1000 (700-1200)	0.12 (0.05-0.2)
		HTi10		

1. Revolution (min^{-1}) = $(1000 \times \text{Cutting speed}) \div (3.14 \times \text{ØD1})$
2. Table feed (mm/min) = Feed per tooth \times Number of teeth \times Cutter revolution



NSE300/400



90° FACE MILLING GENERAL CUTTING

P **M** **K** **N**



C H: 0°
A.R: +16° T: +5° - +8°
R.R: +5° - +8° l: +16°

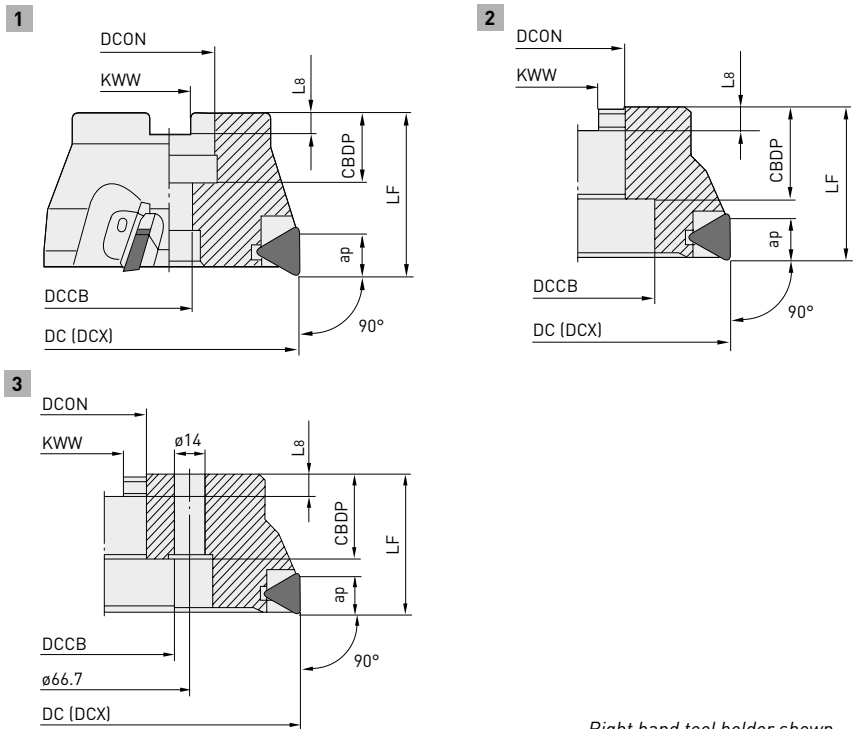

Right hand tool holder shown.

ARBOR TYPE

Order number	Stock	ZEFP	DC	DCX	LF	DCON	CBDP	DCCB	KWW	L8	WT	APMX	Type
NSE300-050A04R-E	●	4	50	50	40	22	20	11	10.4	6.3	0.3	12.5	1
NSE300-063A05R-E	●	5	63	63	40	22	20	11	10.4	6.3	0.5	12.5	1
NSE300-080A06R-E	●	6	80	80	50	27	22	13.5	12.4	7	1.1	12.5	1
NSE300-100A08R-E	●	8	100	100	50	32	25	17.5	14.4	8	2.1	12.5	1
NSE300-125B10R-E	●	10	125	125	63	40	32	56	16.4	9	3.2	12.5	2
NSE300-160C12R-E	□	12	160	160	63	40	29	56	16.4	9	5.4	12.5	3
NSE400-080A06R-E	□	6	80	80	50	27	22	13.5	12.4	7	1.1	17	1
NSE400-100A07R-E	□	7	100	100	50	32	25	17.5	14.4	8	2.1	17	1
NSE400-125B08R-E	□	8	125	125	63	40	32	56	16.4	9	3.2	17	2
NSE400-160C10R-E	□	10	160	160	63	40	29	56	16.4	9	5.4	17	3



SPARE PARTS

Tool holder number	Locator	Wedge-T	Locator	Wedge-T	Clamp screw	Locator screw	Wrench (Clamp screw)	Wrench (Sold separately)
NSE300-050A04R-E		CWTSE300TR			LS19T		TKY15T	
NSE300-063A05R-E	SPTSE300R							
NSE300-080A06R-E		CWNSE300TR			LS10T	TS32		TKY08F
NSE300-160C12R-E							TKY25T	
NSE400-E			SPTSE400R	CWSE300TR	LS10TS			

* Clamp Torque (N • m) : LS10T=8.5. LS10TS=8.5. LS19T=5.0. TS32=1.0

● : Inventory maintained. □ : Produced to order only

INSERTS

P	Steel	●	●	●	●	●	●	●	●	Cutting conditions : ●:Stable cutting ●:General cutting ✖:Unstable cutting
M	Stainless steel	●	●	●	●	●	●	●	●	
K	Cast iron	✖	✖	✖	✖	✖	✖	✖	✖	Honing: ●:Round F:Sharp S:Chamfer + Hone T:Chamfer Z:Strong
N	Non-ferrous metal	●	●	●	●	●	●	●	●	

Order number	Class	Honing	F7030	MC5020	VP15TF	UP20M	NX2525	NX4545	UT120T	HT10	IC	S	BS	RE	Shape
TECN1603PEFR1W	C	F	●							★	9.525	3.175	1.4	0.4	
TECN1603PEER1W	C	E	●							★	9.525	3.175	1.4	0.4	
TECN1603PETR1W	C	T					★	★	★		9.525	3.175	1.4	0.4	
TEEN1603PEFR1	E	F								●	9.525	3.175	1.4	0.4	
TEEN1603PEER1	E	E								●	9.525	3.175	1.4	0.4	
TEEN1603PETR1	E	T				●	●	●	●		9.525	3.175	1.4	0.4	
TEEN1603PESR1	E	S	●	●							9.525	3.175	1.4	0.4	
TEEN1603PEZR1	E	Z					●				9.525	3.175	1.4	0.4	
TECN2204PEFR1	C	F								★	12.7	4.76	1.4	1.0	
TECN2204PETR1	C	T							★		12.7	4.76	1.4	1.0	
TEEN2204PEFR1	E	F								●	12.7	4.76	1.4	1.0	
TEEN2204PEER1	E	E			★					●	12.7	4.76	1.4	1.0	
TEEN2204PETR1	E	T				●	★	●	●		12.7	4.76	1.4	1.0	
TEEN2204PESR1	E	S	●	●							12.7	4.76	1.4	1.0	
Inserts with breaker															
TEER1603PEER-JS	E	E	●							●	9.525	3.175	1.4	0.4	
TEER2204PEER-JS	E	E	●							★	12.7	4.76	1.4	1.0	

NSE300/400

RECOMMENDED CUTTING CONDITIONS

Material	Hardness	Grade	Vc	fz
P Mild steel	<180HB	F7030	240 (160-290)	0.2 (0.1-0.3)
		NX4545		
		UTi20T	190 (125-230)	
		UP20M		
P Carbon steel Alloy steel	180-280HB	F7030	200 (135-240)	0.2 (0.1-0.3)
		NX4545		
		UTi20T	160 (110-190)	
		UP20M		
M Stainless steel	<200HB	UTi20T	160 (125-200)	0.2 (0.1-0.3)
		UP20M		
K Cast iron	Tensile strength <450MPa	MC5020	200 (130-240)	0.2 (0.1-0.3)
		F5010		
		F5020	160 (110-190)	
		HTi10		
N Aluminium alloy	-	MD220	1000 (200-1500)	0.15 (0.05-0.25)
		HTi10	800 (560-960)	0.12 (0.05-0.2)

1. Revolution (min^{-1}) = $(1000 \times \text{Cutting speed}) \div (3.14 \times \text{ØD1})$

2. Table feed (mm/min) = Feed per tooth \times Number of teeth \times Cutter revolution



RRD

ROUND INSERT TYPE CUTTERS

VERSATILE PERFORMANCE AND LONG TOOL LIFE



Mplus...

RRD

PRODUCT FEATURES



- Round insert type cutter for mould & die machining
- Versatile range of insert grades for machining up to 60 HRC
- Large range of cutters available, arbor, screw-in, shank and Weldon types
- Wide range of insert sizes, R2.5, 3.5, 5.0, 6.0 and 8.0

RRD

ROUND INSERT TYPE CUTTERS

RRD CUTTERS



FEATURES

Inserts are available in 3 different tolerances to suit all applications.

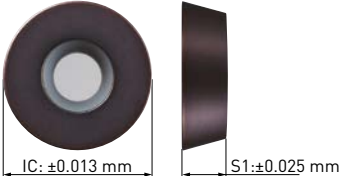
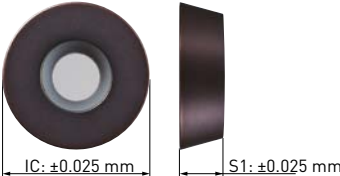
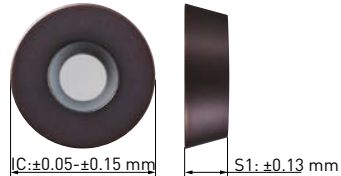
RDHX	RDZX	RDMX
<ul style="list-style-type: none"> • Ground (H Tolerance) • For high precision • For semi-finishing and finishing 	<ul style="list-style-type: none"> • Precision sintered (E Tolerance) • For universal use • Economical insert with long tool life 	<ul style="list-style-type: none"> • Sintered (M Tolerance) • For universal use • For roughing and semi-finishing
 <p>IC: ± 0.013 mm S1: ± 0.025 mm</p>	 <p>IC: ± 0.025 mm S1: ± 0.025 mm</p>	 <p>IC: $\pm 0.05 - \pm 0.15$ mm S1: ± 0.13 mm</p>

GRADE OVERVIEW

	P	Coated carbide					Uncoated carbide	K	Coated carbide		Uncoated carbide	H	Coated carbide		
↑ Wear resistance	P01	VP05HT	VP10H	VP15TF	VP20M	F7030	UT120T	K01	VP15TF	UT120T	H01	VP05HT	VP10H	VP15TF	
↓ Toughness	P20						K10			H10					
	P30						K20			H20					
	P40						K30			H30					

RRD N

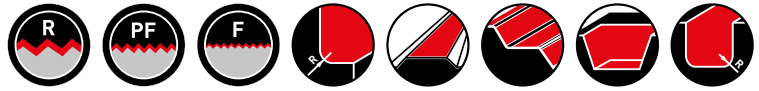

P **K** **H**

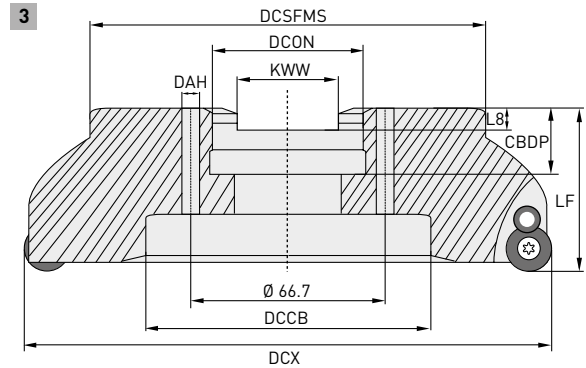
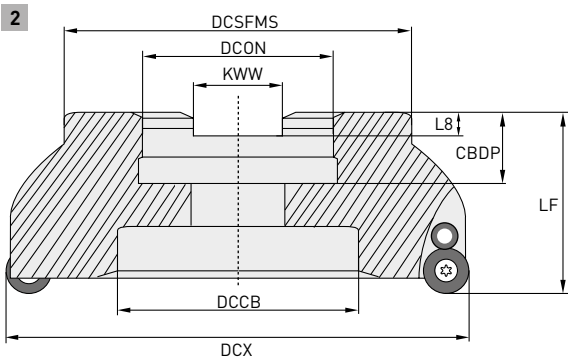
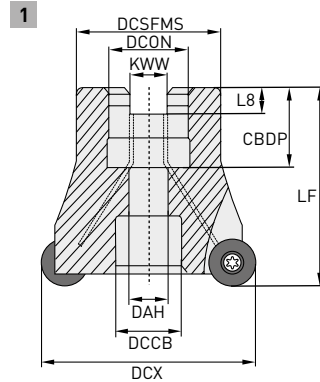

Right hand tool holder only.

ARBOR TYPE (Neutral)

Order number	Stock	APMX	DCX	DC	LF	DCON	CBDP	DAH	DCSFMS	KWW	L8	DCCB	ZEFP			
RRD050N-042A06R	●	5	42	32	44	16	18	9	33	8.4	5.7	15	6	○	1	RDH/M/Z 1003M0
RRD050N-052A07R	●	5	52	42	50	22	20	11	44	10.4	6.3	18	7	○	1	
RRD060N-042A05R	●	6	42	30	42	16	18	9	33	8.4	5.7	15	5	○	1	RDH/M/Z 12T3M0
RRD060N-050A05R	●	6	50	38	50	22	20	11	44	10.4	6.3	18	5	○	1	
RRD060N-052A05R	●	6	52	40	50	22	20	11	44	10.4	6.3	18	5	○	1	RDH/M/Z 1604M0
RRD060N-063A06R	●	6	63	51	50	22	20	11	44	10.4	6.3	18	6	○	1	
RRD080N-050A04R	●	8	50	34	50	22	20	11	44	10.4	6.3	18	4	○	1	RDH/M/Z 1604M0
RRD080N-052A04R	●	8	52	36	50	22	20	11	4	10.4	6.3	18	4	○	1	
RRD080N-052A05R	●	8	52	36	50	22	20	11	4	10.4	6.3	18	5	○	1	RDH/M/Z 1604M0
RRD080N-063A05R	●	8	63	47	50	22	20	11	4	10.4	6.3	18	5	○	1	
RRD080N-066A05R	●	8	66	50	50	27	22	13.5	53	12.4	7.2	20	5	○	1	RDH/M/Z 1604M0
RRD080N-080A06R	●	8	80	64	52	27	22	13.5	64	12.4	7.2	20	6	○	1	
RRD080N-100A07R	●	8	100	84	52	32	29	—	72	14.4	8	46	7	—	2	RDH/M/Z 1604M0
RRD080N-125B08R	●	8	125	109	52	40	30	—	82	16.4	9	58	8	—	2	
RRD080N-160C09R	□	8	160	144	52	40	29	14	90	16.4	9	92	9	—	3	





1. ○ = With through coolant holes



● : Inventory maintained. □ : Produced to order only

RRD N

SPARE PARTS

Order number	RE					
		Shim	Shim screw	Clamp screw	Insert clamp screw	Wrench
RRD050N-	042A06R	5			—	
	052A07R					
RRD060N-	042A05R	6	—	B-TS35	TS1001	TKY15F
	050A05R					
	052A05R					
	063A06R					
	050A04R					
RRD080N-	052A04R	8	KS-12	B-TS45	214	TKY20F
	052A05R					
	063A05R					
	066A05R					
	080A06R					
	100A07R					
	125B08R					
160C09R						

RRD P

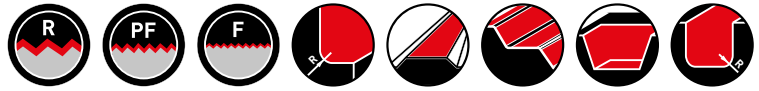

P K H

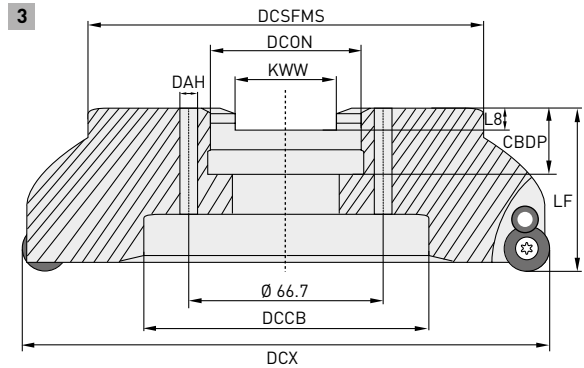
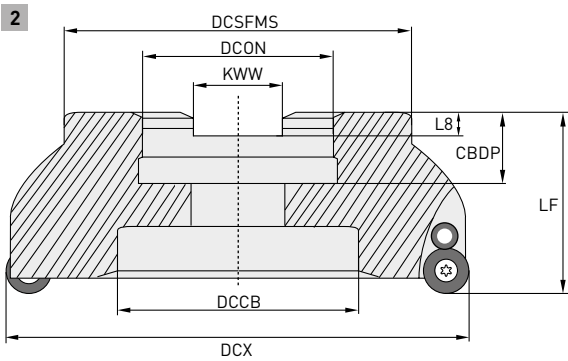
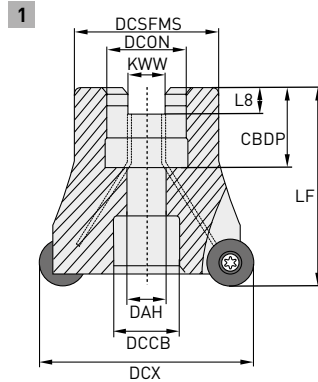

Right hand tool holder only.

ARBOR TYPE (Positive)

Order number	Stock	APMX	DCX	DC	LF	DCON	CBDP	DAH	DCSFMS	KWW	L8	DCCB	ZIPP	Typ		
RRD060P-050A05R	●	6	50	38	50	22	20	11	44	10.4	6.3	18	5	○	1	RDH/M/Z 12T3M0E
RRD060P-052A05R	●	6	52	40	50	22	20	11	44	10.4	6.3	18	5	○	1	
RRD060P-063A06R	●	6	63	51	50	22	20	11	44	10.4	6.3	18	6	○	1	
RRD060P-066A06R	●	6	66	54	52	27	22	13.5	53	12.4	7.2	20	6	○	1	
RRD060P-080A07R	●	6	80	68	50	27	22	13.5	64	12.4	7.2	20	7	○	1	
RRD080P-050A04R	●	8	50	34	50	22	20	11	44	10.4	6.3	18	4	○	1	RDH/M/Z 1604M0E
RRD080P-063A05R	●	8	63	47	50	22	20	11	44	10.4	6.3	18	5	○	1	
RRD080P-066A05R	●	8	66	50	50	27	22	13.5	53	12.4	7.2	20	5	○	1	
RRD080P-080A06R	●	8	80	64	52	27	22	13.5	64	12.4	7.2	20	6	○	1	
RRD080P-100A07R	●	8	100	84	52	32	29	—	72	14.4	8	46	7	—	2	
RRD080P-125B08R	●	8	125	109	52	40	30	—	82	16.4	9	58	8	—	2	
RRD080P-160C09R	●	8	160	144	52	40	29	14	90	16.4	9	92	9	—	3	





1. ○ = With through coolant holes



● : Inventory maintained. □ : Produced to order only

RRD P

SPARE PARTS

Order number	RE						
		Shim	Shim screw	Clamp screw	Insert clamp screw	Wrench	
RRD060P-	050A05R						
	052A05R						
	063A06R	6	—	—	B-TS35	TS1001	TKY15F
	066A06R						
	080A07R						
RRD080P-	050A04R						
	063A05R						
	066A05R						
	080A06R	8	KS-12	B-TS45	214	—	TKY20F
	100A07R						
	125B08R						
	160C09R						

RRD

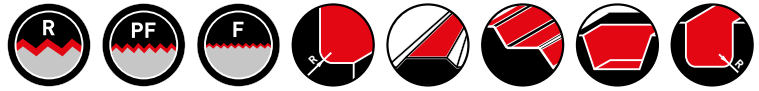

P **K** **H**

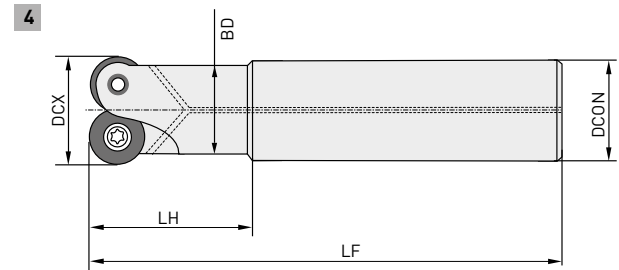
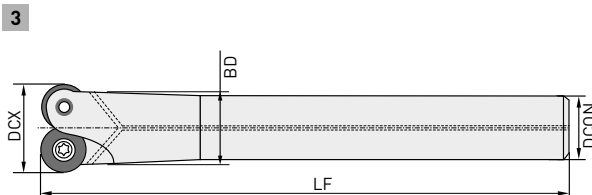
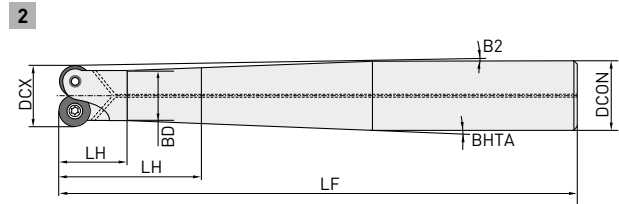
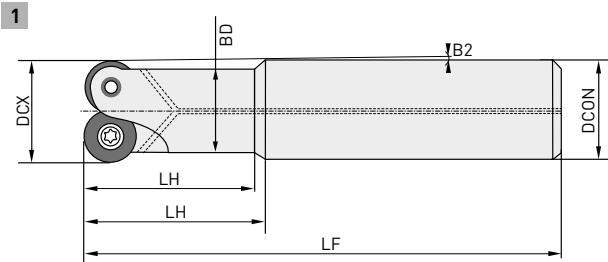
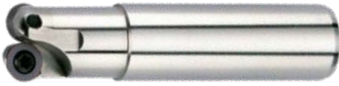





Right hand tool holder only.

STRAIGHT SHANK TYPE

Order number	Stock	APMX	DCX	DCON	LF	LU	LH	BD	B2	BHTA	ZEFP	Typ	
RRD025R102S10Z	●	2.5	10	10	75	—	23	—	—	0.89	2	4	RDH/Z 0501M0
RRD025R123S12Z	●	2.5	12	12	75	—	23	11	—	—	3	4	
RRD025R154S16Z	●	2.5	15	16	80	22	22.5	14	1.4	45	4	1	
RRD035R122S10Z	●	3.5	12	10	75	23	—	11	—	—	2	3	RDH/M/Z 07T1M0
RRD035R122S12Z	●	3.5	12	12	75	—	23	11	—	—	2	4	
RRD035R122S16Z	□	3.5	12	16	88	15	18.4	11	4	8.37	2	2	
RRD035R122S16ZL	●	3.5	12	16	128	15	22.4	11	2.36	3.87	2	2	
RRD035R122S16ZM	●	3.5	12	16	109	15	22.4	11	2.36	3.87	2	2	
RRD035R152S16Z	□	3.5	15	16	88	18	27.6	14	1	6.52	2	2	RDH/M/Z 0702M0
RRD035R152S16ZM	●	3.5	15	16	108	18	41.4	14	0.59	2.69	2	2	
RRD035R152S20Z	●	3.5	15	20	130	20	35.6	14	2.12	4.04	2	2	
RRD035R152S20ZM	●	3.5	15	20	150	20	41.7	14	1.64	2.9	2	2	
RRD035R152S25Z	□	3.5	15	25	176	20	36.8	14	2.64	3.8	2	2	
RRD035R153S12Z	□	3.5	15	12	75	17	—	12.8	—	—	3	3	RDH/M/Z 07T1M0
RRD035R153S16Z	□	3.5	15	16	78	29.5	30	14	1.08	45	3	1	
RRD050R202S20Z	●	5	20	20	90	—	31	18	—	—	2	4	RDH/M/Z 1003M0
RRD050R202S20ZM	●	5	20	20	110	—	51	18	—	—	2	4	
RRD050R202S25Z	●	5	20	25	136	68.5	69.5	18	2.13	45	2	1	
RRD050R202S25ZL	●	5	20	25	176	108.5	109.5	18	1.34	45	2	1	
RRD050R202S25ZM	●	5	20	25	156	88.5	89.5	18	1.64	45	2	1	

RRD

SPARE PARTS

Order number	RE						
		Shim	Shim screw	Clamp screw	Insert clamp screw	Wrench	
RRD025R-	102S10Z						
	123S12Z	2.5	—	—	B-TS20	—	TKY06F
	54S16Z						
RRD035R-	122S10Z						
	122S12Z						
	122S16Z	3.5	—	—	B-TS253	—	TKY07F
	122S16ZL						
	122S16ZM						
	152S16Z						
	152S16ZM						
	152S20Z		—	—	TS25	—	TKY08F
	152S20ZM						
	152S25Z						
RRD050R-	153S12Z		—	—	TS253	—	TKY08F
	153S16Z						
	202S20Z						
	202S20ZM						
	202S25Z	5	—	—	B-TS35	—	TKY15F
	202S25ZL						
	202S25ZM						

RRD

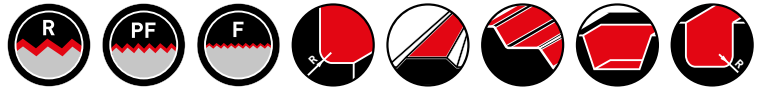

P K H

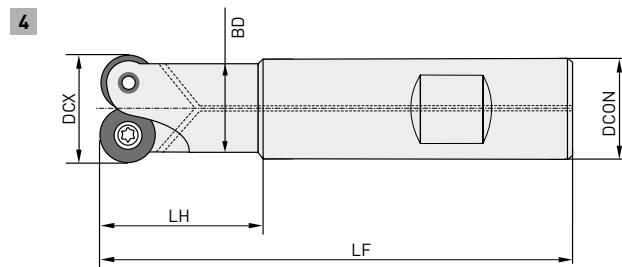
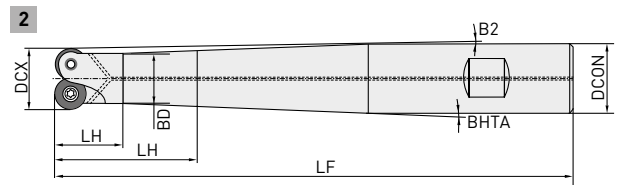
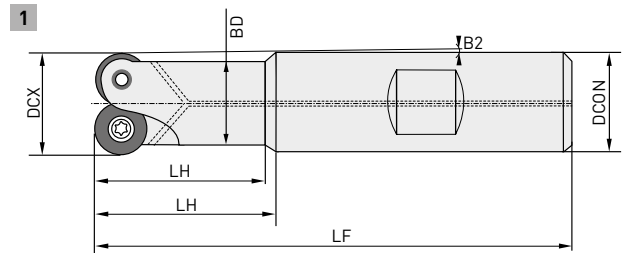
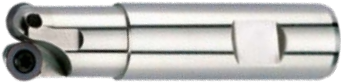





Right hand tool holder only.

WELDON SHANK TYPE

Order number	Stock	APMX	DCX	DCON	LF	LU	LH	BD	B2	BHTA	ZEFP	Typ	
RRD035R122S16W	●	3.5	12	16	88	15	18.4	11	4	8.37	2	2	RDH/M/Z 07T1M0
RRD035R122S16WL	●	3.5	12	16	128	15	22.4	11	2.36	3.87	2	2	
RRD035R122S16WM	□	3.5	12	16	108	15	22.4	11	2	3.87	2	2	
RRD035R152S16W	□	3.5	15	16	88	18	27.6	12.8	1	6.52	2	2	RDH/M/Z 0702M0
RRD035R152S16WM	□	3.5	15	16	108	18	41.38	12.8	0.59	2.69	2	2	
RRD035R152S20W	□	3.5	15	20	130	20	35.58	12.8	2.12	4.04	2	2	
RRD035R152S20WM	□	3.5	15	20	150	20	41.7	12.8	1.64	2.9	2	2	RDH/M/Z 07T1M0
RRD035R152S25W	□	3.5	15	25	176	20	36.8	12.8	3.8	2.65	2	2	
RRD035R153S16W	□	3.5	15	16	78	28.4	29.5	12.8	1.08	45	3	1	
RRD050R202S20W	●	5	20	20	90	—	31	18	—	—	2	4	RDH/M/Z 1003M0
RRD050R202S20WM	●	5	20	20	110	—	51	18	—	—	2	4	
RRD050R202S25W	●	5	20	25	136	23	37	18	2.13	4.09	2	2	
RRD050R202S25WL	□	5	20	25	176	47.6	23	18	1.34	2.25	2	2	RDH/M/Z 1003M0
RRD050R202S25WM	□	5	20	25	156	42.7	23	18	1.64	2.9	2	2	

RRD

SPARE PARTS

Order number	RE						
		Shim	Shim screw	Clamp screw	Insert clamp screw	Wrench	
	122S16W						
	122S16WL	—	—	B-TS253	—	TKY07F	
	122S16WM						
RRD035R-	152S16W						
	152S16WM	3.5					
	152S20W			TS25		TKY08F	
	152S20WM	—	—		—		
	152S25W						
	153S16W			TS253			
RRD050R-	202S20W						
	202S20WM						
	202S25W	5	—	—	B-TS35	—	TKY15F
	202S25WL						
	202S25WM						

RRD

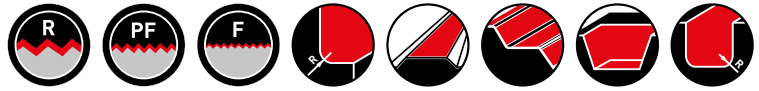

P **K** **H**

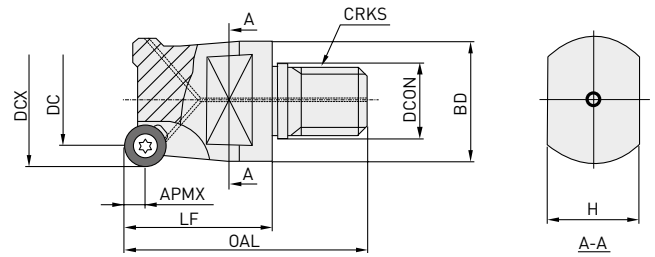





Right hand tool holder only.

SCREW-IN TYPE

Order number	Stock	APMX	DCX	DC	OAL	LF	DCON	DCSFMS	CRKS	H	ZEFP	
RRD025R102M5	□	2.5	10	5	35	20	5.5	9.9	M5	6	2	
RRD025R123M8	●	2.5	12	7	38	20	8.5	13.5	M8	9	3	RDH/Z
RRD025R154M8	●	2.5	15	10	38	20	8.5	13.5	M8	10	4	0501M0
RRD025R205M10	●	2.5	20	15	44	25	10.5	18	M10	15	5	
RRD035R122M8	●	3.5	12	5	46	28	8.5	13.5	M8	9	2	
RRD035R153M8	●	3.5	15	8	46	28	8.5	13.5	M8	10	3	
RRD035R204M10	●	3.5	20	13	47	28	10.5	18	M10	15	4	RDH/M/Z
RRD035R255M12	●	3.5	25	18	50	28	12.5	21	M12	17	5	07T1M0
RRD035R306M16	●	3.5	30	23	51	28	17	29	M16	22	6	
RRD035R357M16	●	3.5	35	28	51	28	17	29	M16	22	7	
RRD035R152M8	●	3.5	15	8	46	28	8.5	13.5	M8	10	2	RDH/M/Z
RRD035R153M8X	●	3.5	15	8	43	28	8.5	13.5	M8	10	3	0702M0
RRD050R202M10	●	5	20	10	47	28	10.5	18	M10	15	2	
RRD050R252M12	●	5	25	15	54	32	12.5	21	M12	17	2	
RRD050R253M12	●	5	25	15	54	32	12.5	21	M12	17	3	
RRD050R304M12	●	5	30	20	54	32	12.5	21	M12	17	4	RDH/M/Z
RRD050R304M16	●	5	30	20	55	32	17	29	M16	22	4	1003M0
RRD050R355M16	●	5	35	25	65	42	17	29	M16	22	5	
RRD050R426M16	●	5	42	32	65	42	17	29	M16	22	6	
RRD060R242M12	●	6	24	12	54	32	12.5	21	M12	17	2	
RRD060R353M16	●	6	35	23	65	42	17	29	M16	22	3	
RRD060R354M16	●	6	35	23	65	42	17	29	M16	22	4	RDH/M/Z
RRD060R424M16	●	6	42	30	55	32	17	29	M16	24	4	12T3M0
RRD060R425M16	●	6	42	30	65	42	17	29	M16	22	5	
RRD080R322M16	●	8	32	16	65	42	17	29	M16	22	2	RDH/M/Z 1604M0

SPARE PARTS

Order number	RE								
		Shim	Shim screw	Clamp screw	Insert clamp screw	Wrench			
RRD025R-	102M5	2.5	—	—	B-TS20	—	TKY06F		
	123M8								
	154M8								
	205M10								
RRD035R-	122M8	3.5	—	—	B-TS253	—	TKY07F		
	153M8								
	204M10								
	255M12				TS253			—	TKY08F
	306M16								
	357M16								
	152M8				TS25			—	TKY08F
153M8X									
RRD050R-	202M10	5	—	—	B-TS35	—	TKY15F		
	252M12								
	253M12								
	304M12								
	304M16								
	355M16								
426M16									
RRD060R-	242M12	6	—	—	B-TS35	—	TKY15F		
	353M16								
	354M16							TS1001	
	424M16								
425M16									
RRD080R-	322M16	8	—	—	214	—	TKY20F		

INSERTS

P	Steel	●	●	●	●	●	●
K	Cast iron		✘	✘	●	●	✘
H	Hardened materials		●		●	●	

Cutting conditions:
 ●: Stable cutting ●: General cutting ✘: Unstable cutting

Order number	Class	Honing	F7030	VP15TF	VP20M	VP10H	VP05HT	UTi20T	IC	S
RDHX0501M0E	H	E	●	●		●	●		5	1.5
RDHX0501M0S	H	S	●	●		●			5	1.5
RDHX07T1M0E	H	E	●	●		●	●		7	1.98
RDHX07T1M0S	H	S	●	●		●	●		7	1.98
RDHX0702M0E	H	E	●	●		●	●		7	2.38
RDHX0702M0S	H	S	●	●		●			7	2.38
RDHX1003M0E	H	E	●	●		●	●		10	3.18
RDHX1003M0S	H	S	●	●		●	●		10	3.18
RDHX12T3M0E	H	E	●	●		●	●		12	3.97
RDHX12T3M0S	H	S	●	●		●			12	3.97
RDHX1604M0E	H	E	●	●		●	●		16	4.76
RDHX1604M0S	H	S	●	●		●			16	4.76
RDMX07T1M0E	M	E					●		7	1.98
RDMX07T1M0T	M	T	●	●	●				7	1.98
RDMX0702M0E	M	E					●		7	2.38
RDMX0702M0T	M	T	●	●	●		□		7	2.38
RDMX1003M0E	M	E					●		10	3.18
RDMX1003M0S	M	S		●	●				10	3.18
RDMX1003M0T	M	T	●	●	●		●		10	3.18
RDMX12T3M0E	M	E					●		12	3.97
RDMX12T3M0S	M	S		●	●				12	3.97
RDMX12T3M0T	M	T	●	●	●		●		12	3.97
RDMX1604M0E	M	E					●		16	4.76
RDMX1604M0S	M	S		●	●				16	4.76
RDMX1604M0T	M	T	●	●	●		●		16	4.76
RDZX0501M0E	Z	E		●					5	1.50
RDZX07T1M0E	Z	E		●					7	1.98
RDZX0702M0E	Z	E		●					7	2.38
RDZX1003M0E	Z	E		●					10	3.18
RDZX1003M0S	Z	S	●	●					10	3.18
RDZX12T3M0E	Z	E		●					12	3.97
RDZX12T3M0S	Z	S	●	●					12	3.97
RDZX1604M0E	Z	E		●					16	4.76
RDZX1604M0S	Z	S	●	●					16	4.76

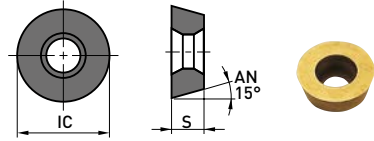

IC: ±0.013 mm S: ±0.025 mm

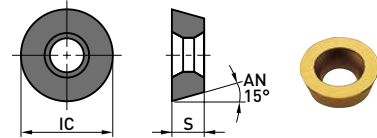

IC: ±0.05-±0.15 mm S: ±0.15 mm

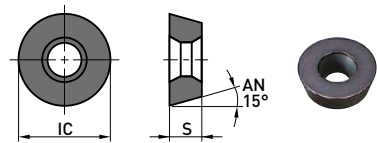

IC: ±0.025 mm S: ±0.025 mm

CUTTING EDGE PREPARATION

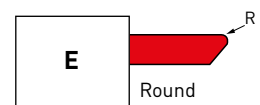
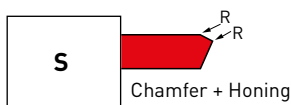

● For roughing

● For roughing and finishing

● For finishing

● : Inventory maintained. □ : Produced to order only

RRD

RECOMMENDED CUTTING CONDITIONS

CUTTING CONDITIONS FOR ROUGHING (ae = 50 % of Ø)

Material	Hardness	Grade	Vc	Ø 10-15 mm		Ø 20 mm		Ø 24-25 mm		Ø 30-42 mm		Ø 50-80 mm		Ø 100-160 mm		
				ap	fz	ap	fz	ap	fz	ap	fz	ap	fz	ap	fz	
P	Mild steel	<180HB	F7030 VP15TF	[250-320]	-0.2	0.25	-0.5	0.45	-1.0	0.35	-1.0	0.40	-1.0	0.50	-1.5	0.60
				[240-300]	0.2-0.3	0.20	0.5-1.0	0.25	1.0-2.0	0.30	1.5-2.0	0.32	1.0-1.5	0.40	1.5-2.5	0.45
				[200-280]	0.3-0.5	0.12	1.0-1.5	0.15	2.0-2.5	0.20	2.0-3.0	0.25	1.5-3.0	0.35	2.5-5.0	0.35
P	Carbon steel Alloy steel	180- 350HB	F7030 VP15TF	[220-300]	-0.2	0.20	-0.5	0.40	-1.0	0.30	-1.0	0.40	-1.0	0.50	-1.5	0.55
				[200-290]	0.2-0.3	0.15	0.5-1.0	0.20	1.0-1.5	0.25	1.5-2.0	0.30	1.0-1.5	0.38	1.5-2.5	0.40
				[160-250]	0.3-0.5	0.10	1.0-1.5	0.10	1.5-2.0	0.22	2.0-3.0	0.22	1.5-3.0	0.30	2.5-4.5	0.32
K	Cast iron	Tensile Strength <450MPa	VP15TF VP20M VP10H	[200-250]	-0.1	0.15	-0.5	0.18	-1.0	0.20	-1.0	0.25	-1.0	0.30	-1.5	0.35
				[180-230]	0.1-0.2	0.10	0.5-1.0	0.10	1.0-1.5	0.15	1.5-2.0	0.18	1.0-1.5	0.25	1.5-2.5	0.22
				[160-200]	0.2-0.25	0.10	1.0-1.5	0.10	1.5-2.0	0.12	2.0-3.0	0.15	1.5-3.0	0.18	2.5-4.5	0.20
H	Hardened steel	-52HRC -58HRC -60HRC	VP15TF VP10H VP05HT	[140-200]	-0.1	0.12	-0.1	0.14	-0.1	0.15	-0.1	0.18	-0.1	0.18	-0.1	0.20
				[110-180]	0.1-0.15	0.10	0.1-0.20	0.12	0.1-0.30	0.12	0.1-0.30	0.14	0.1-0.30	0.14	0.1-0.30	0.15
				[100-170]	0.1-0.15	0.10	0.1-0.20	0.10	0.1-0.30	0.10	0.1-0.30	0.12	0.1-0.30	0.12	0.1-0.30	0.12

1. When using a full width of cut please reduce the cutting conditions by 20 %.
2. When using a long overhang please reduce the feed rate by 20 %.

CUTTING CONDITIONS FOR FINISHING (ae = 20 % of Ø)

Material	Hardness	Grade	Vc	Ø 10-15 mm		Ø 20 mm		Ø 24-25 mm		Ø 30-42 mm		Ø 50-80 mm		Ø 100-160 mm		
				ap	fz	ap	fz	ap	fz	ap	fz	ap	fz	ap	fz	
P	Mild steel	<180HB	F7030 VP15TF	[260-360]	-0.1	0.15	-0.15	0.20	-0.15	0.25	-0.15	0.30	-0.15	0.32	-0.3	0.35
				[240-320]	0.1-0.2	0.15	0.1-0.2	0.15	0.1-0.2	0.18	0.1-0.3	0.20	0.1-0.3	0.22	0.2-0.3	0.25
				[220-280]	0.2-0.24	0.10	0.1-0.30	0.15	0.1-0.30	0.18	0.1-0.30	0.20	0.2-0.30	0.20	0.3-0.40	0.20
P	Carbon steel Alloy steel	180- 350HB	F7030 VP15TF	[250-350]	-0.1	0.12	-0.1	0.15	-0.1	0.18	-0.1	0.25	-0.1	0.28	-0.15	0.30
				[230-310]	0.1-0.15	0.12	0.1-0.30	0.15	0.1-0.30	0.15	0.1-0.30	0.20	0.1-0.3	0.22	0.15-0.3	0.25
				[210-270]	0.15-0.2	0.10	0.15-0.30	0.12	0.15-0.30	0.15	0.15-0.30	0.15	0.2-0.3	0.18	0.2-0.3	0.18
K	Cast iron	Tensile Strength <450MPa	VP15TF VP20M VP10H	[200-300]	-0.1	0.15	-0.1	0.18	-0.1	0.20	-0.1	0.22	-0.1	0.25	-0.15	0.30
				[200-280]	0.1-0.2	0.10	0.1-0.30	0.10	0.1-0.3	0.15	0.1-0.3	0.15	0.1-0.3	0.20	0.15-0.3	0.22
				[180-240]	0.2-0.25	0.10	0.2-0.40	0.10	0.2-0.4	0.12	0.2-0.4	0.12	0.2-0.4	0.15	0.2-0.4	0.18
H	Hardened steel	-52HRC -58HRC -60HRC	VP15TF VP10H VP05HT	[150-200]	-0.1	0.15	-0.1	0.14	-0.1	0.15	-0.1	0.18	-0.1	0.18	-0.1	0.20
				[120-180]	0.1-0.15	0.10	0.1-0.20	0.12	0.1-0.30	0.12	0.1-0.30	0.14	0.1-0.30	0.14	0.1-0.30	0.15
				[100-180]	0.1-0.15	0.10	0.1-0.20	0.10	0.1-0.30	0.10	0.1-0.30	0.12	0.1-0.30	0.12	0.1-0.30	0.12

1. When using a full width of cut please reduce the cutting conditions by 20 %.
2. When using a long overhang please reduce the feed rate by 20 %.

TAFS, TAFM, TAFL

INDEXABLE INSERT DRILL

LOW DRILLING NOISE AND TOUGH BODY



*M*plus...

TAFS, TAFM, TAFL

INDEXABLE INSERT DRILL

FEATURES

Tough body

- The wide web design reduces chattering.
- Lower cutting noise.
- High insert seat rigidity for reliable insert location

Economical insert

- Economical four corner use

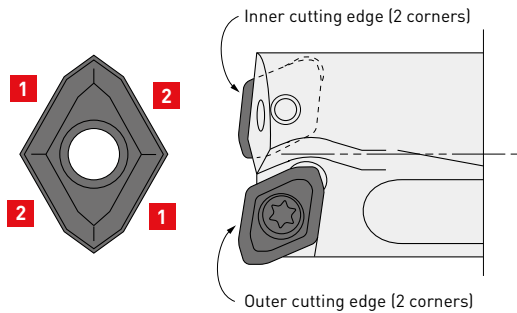
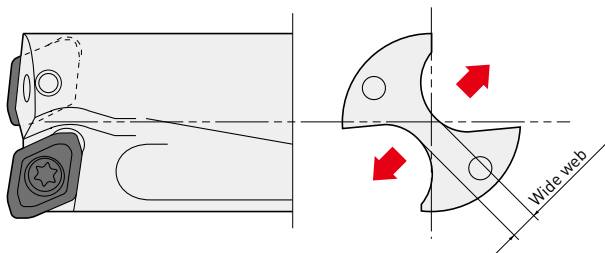

1 Inner edge

2 Outer edge



TAFS, TAFM, TAFL

CUTTING PERFORMANCE

CHIP GEOMETRY

U1 Breaker

Material	Mild steel
Drill diameter (mm)	Ø 25
Vc (m/min)	200
f (mm/rev)	0.10



U2 Breaker

Material	DIN X5CrNi189
Drill diameter (mm)	Ø 25
Vc (m/min)	150
f (mm/rev)	0.10



U3 Breaker

Material	DIN Ck45
Drill diameter (mm)	Ø 25
Vc (m/min)	150
f (mm/rev)	0.14



U3 Breaker

Material	DIN 42CrMo4
Drill diameter (mm)	Ø 25
Vc (m/min)	150
f (mm/rev)	0.12



CUTTING RESISTANCE

POWER CONSUMPTION

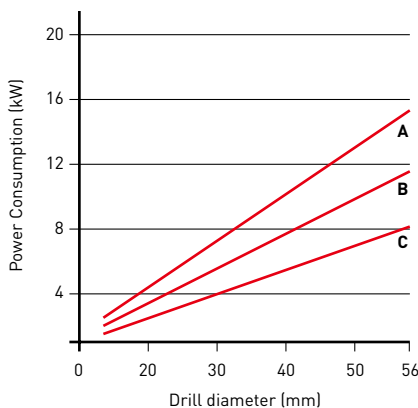

TORQUE

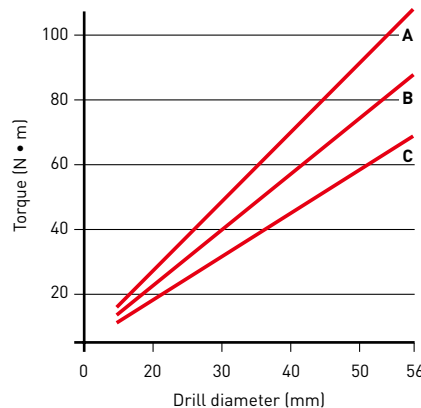

THRUST

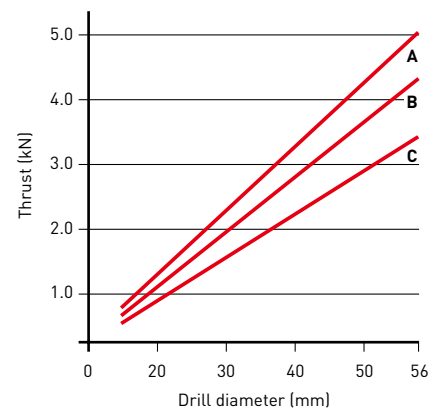

1. Workpiece: DIN X5CrNi189 (220HB) Cutting speed: 150 m/min Insert: U2 Breaker

A: f = 0.15 mm/rev B: f = 0.1 mm/rev C: f = 0.06 mm/rev

TAFS, TAFM, TAFL

CUTTING NOISE

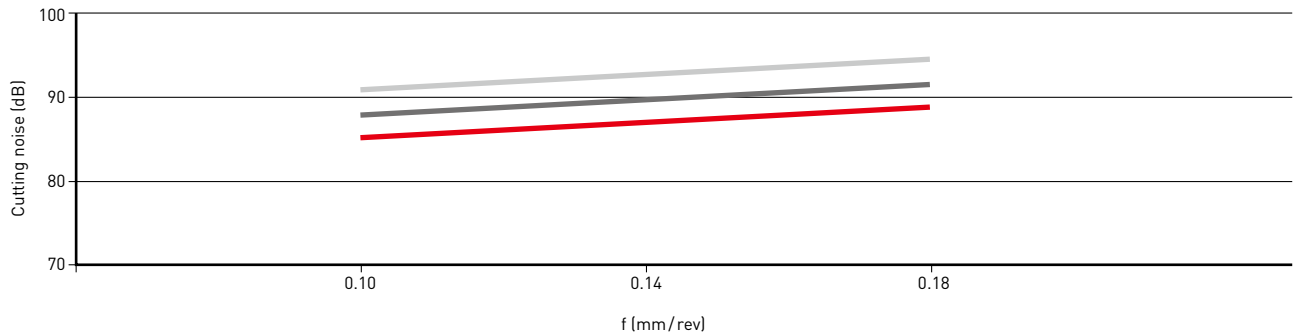

1. Workpiece: DIN 42CrMo4 (200-220 HB) Drill diameter (mm): Ø 25 Cutting speed: 150 m/min Insert: U2 Breaker

CUTTING RESISTANCE

POWER CONSUMPTION

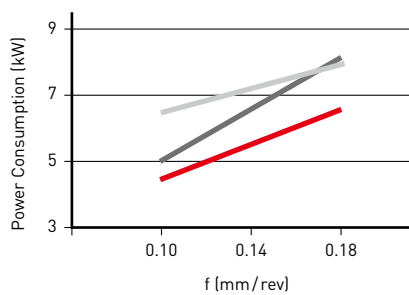

TORQUE

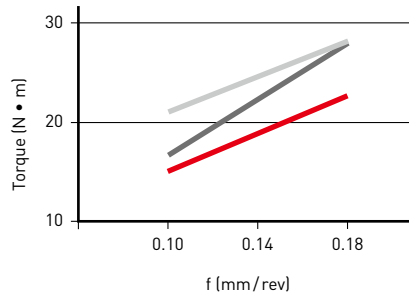

THRUST

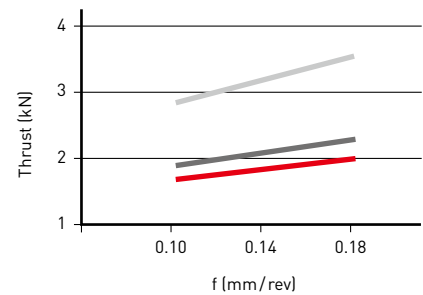

1. Workpiece: DIN 42CrMo4 (200-220 HB) Drill diameter (mm): Ø 25 Cutting speed: 150 m/min Insert: U3 Breaker

IDENTIFICATION

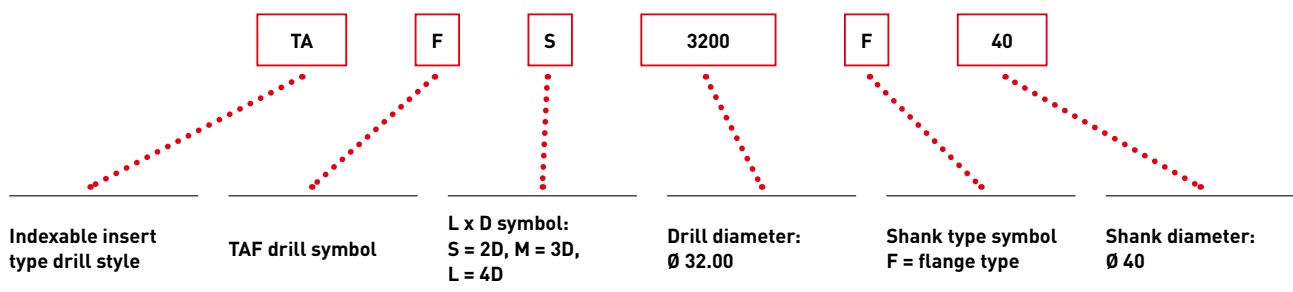

TAFS, TAFM, TAFL

P M K

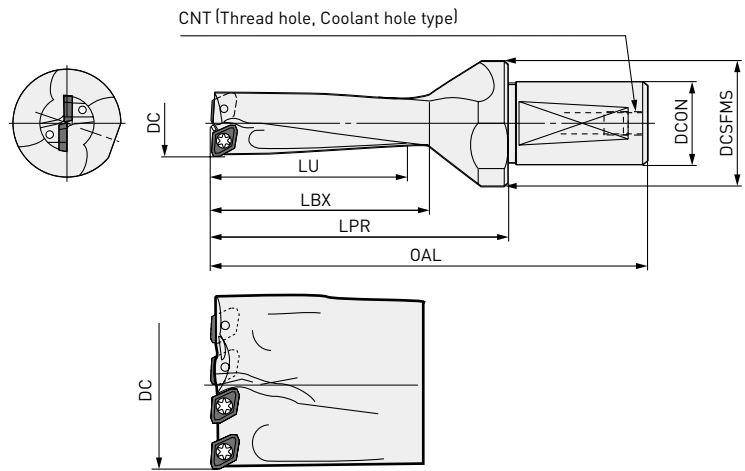

Number of Teeth = 4 (DC > 49)

Order number	Stock	DC	L/D	ZNF	LU	LBX	LPR	OAL	DCON	DCSFMS	CNT	Insert
TAFS1200F20	●		2		24	29	39	82	20	25	PT1/8	
TAFM1200F20	●	12.0	3	2	36	41	51	94	20	25	PT1/8	GCMT040204-U \odot
TAFL1200F20	●		4		48	53	63	106	20	25	PT1/8	
TAFS1250F20	●		2		25	29	39	82	20	25	PT1/8	
TAFM1250F20	●	12.5	3	2	37.5	41	51	94	20	25	PT1/8	GCMT040204-U \odot
TAFL1250F20	●		4		50	53	63	106	20	25	PT1/8	
TAFS1300F20	●		2		26	31	41	84	20	25	PT1/8	
TAFM1300F20	●	13.0	3	2	39	44	54	97	20	25	PT1/8	GCMT040204-U \odot
TAFL1300F20	●		4		52	57	67	110	20	25	PT1/8	
TAFS1350F20	●		2		27	31	41	84	20	25	PT1/8	
TAFM1350F20	●	13.5	3	2	40.5	44	54	97	20	25	PT1/8	GCMT040204-U \odot
TAFL1350F20	●		4		54	57	67	110	20	25	PT1/8	
TAFS1400F20	●		2		28	33	43	86	20	25	PT1/8	
TAFM1400F20	●	14.0	3	2	42	47	57	100	20	25	PT1/8	GCMT040204-U \odot
TAFL1400F20	●		4		56	61	71	114	20	25	PT1/8	
TAFS1450F20	●		2		29	33	43	86	20	25	PT1/8	
TAFM1450F20	●	14.5	3	2	43.5	47	57	100	20	25	PT1/8	GCMT040204-U \odot
TAFL1450F20	●		4		58	61	71	114	20	25	PT1/8	
TAFS1500F20	●		2		30	35	45	88	20	25	PT1/8	
TAFM1500F20	●	15.0	3	2	45	50	60	103	20	25	PT1/8	GPMT060204-U \odot
TAFL1500F20	●		4		60	65	75	118	20	25	PT1/8	
TAFS1550F20	●		2		31	35	45	88	20	25	PT1/8	
TAFM1550F20	●	15.5	3	2	46.5	50	60	103	20	25	PT1/8	GPMT060204-U \odot
TAFL1550F20	●		4		62	65	75	118	20	25	PT1/8	
TAFS1600F25	●		2		32	38	57	107	25	35	PT1/8	
TAFM1600F25	●	16.0	3	2	48	54	73	123	25	35	PT1/8	GPMT060204-U \odot
TAFL1600F25	●		4		64	70	89	139	25	35	PT1/8	
TAFS1650F25	●		2		33	38	57	107	25	35	PT1/8	
TAFM1650F25	●	16.5	3	2	49.5	54	73	123	25	35	PT1/8	GPMT060204-U \odot

TAFS, TAFM, TAFL

Order number	Stock	DC	L/D	ZNF	LU	LBX	LPR	OAL	DCON	DCSFMX	CNT	Insert
TAFS1700F25	●		2		34	41	59	109	25	35	PT1/8	
TAFM1700F25	●	17.0	3	2	51	58	76	126	25	35	PT1/8	GPMT060204-U○
TAFL1700F25	●		4		68	75	93	143	25	35	PT1/8	
TAFS1750F25	●		2		35	41	59	109	25	35	PT1/8	
TAFM1750F25	●	17.5	3	2	52.5	58	76	126	25	35	PT1/8	GPMT060204-U○
TAFL1750F25	●		4		70	75	93	143	25	35	PT1/8	
TAFS1800F25	●		2		36	43	61	111	25	35	PT1/8	
TAFM1800F25	●	18.0	3	2	54	61	79	129	25	35	PT1/8	GPMT070204-U○
TAFL1800F25	●		4		72	79	97	147	25	35	PT1/8	
TAFS1850F25	●		2		37	43	61	111	25	35	PT1/8	
TAFM1850F25	●	18.5	3	2	55.5	61	79	129	25	35	PT1/8	GPMT070204-U○
TAFS1900F25	●		2		38	46	63	113	25	35	PT1/8	
TAFM1900F25	●	19.0	3	2	57	65	82	132	25	35	PT1/8	GPMT070204-U○
TAFL1900F25	●		4		76	84	101	151	25	35	PT1/8	
TAFS1950F25	●		2		39	46	63	113	25	35	PT1/8	
TAFM1950F25	●	19.5	3	2	58.5	65	82	132	25	35	PT1/8	GPMT070204-U○
TAFS2000F25	●		2		40	48	65	115	25	35	PT1/8	
TAFM2000F25	●	20.0	3	2	60	68	85	135	25	35	PT1/8	GPMT070204-U○
TAFL2000F25	●		4		80	88	105	155	25	35	PT1/8	
TAFS2050F25	●		2		41	48	65	115	25	35	PT1/8	
TAFM2050F25	●	20.5	3	2	61.5	68	85	135	25	35	PT1/8	GPMT070204-U○
TAFS2100F25	●		2		42	50	67	117	25	35	PT1/8	
TAFM2100F25	●	21.0	3	2	63	71	88	138	25	35	PT1/8	GPMT070204-U○
TAFL2100F25	●		4		84	92	109	159	25	35	PT1/8	
TAFS2150F25	●		2		43	50	67	117	25	35	PT1/8	
TAFM2150F25	●	21.5	3	2	64.5	71	88	138	25	35	PT1/8	GPMT070204-U○
TAFS2200F25	●		2		44	53	69	119	25	35	PT1/8	
TAFM2200F25	●	22.0	3	2	66	75	91	141	25	35	PT1/8	GPMT070204-U○
TAFL2200F25	●		4		88	97	113	163	25	35	PT1/8	
TAFS2250F25	●		2		45	53	69	119	25	35	PT1/8	
TAFM2250F25	●	22.5	3	2	67.5	75	91	141	25	35	PT1/8	GPMT070204-U○
TAFS2300F25	●		2		46	55	71	121	25	35	PT1/8	
TAFM2300F25	●	23.0	3	2	69	78	94	144	25	35	PT1/8	GPMT090304-U○
TAFL2300F25	●		4		92	101	117	167	25	35	PT1/8	
TAFS2350F25	●		2		47	55	71	121	25	35	PT1/8	
TAFM2350F25	●	23.5	3	2	70.5	78	94	144	25	35	PT1/8	GPMT090304-U○
TAFL2350F25	●		4		94	101	117	167	25	35	PT1/8	
TAFS2400F25	●		2		48	58	73	123	25	35	PT1/8	
TAFM2400F25	●	24.0	3	2	72	82	97	147	25	35	PT1/8	GPMT090304-U○
TAFL2400F25	●		4		96	106	121	171	25	35	PT1/8	
TAFS2450F25	●		2		49	58	73	123	25	35	PT1/8	
TAFM2450F25	●	24.5	3	2	73.5	82	97	147	25	35	PT1/8	GPMT090304-U○
TAFS2500F32	●		2		50	60	75	130	32	42	PT1/8	
TAFM2500F32	●		3		75	85	100	155	32	42	PT1/8	
TAFL2500F25	●	25.0	4	2	100	110	125	180	25	35	PT1/8	GPMT090304-U○
TAFL2500F32	●		4		100	110	125	180	32	42	PT1/8	
TAFS2550F32	●		2		51	60	75	130	32	42	PT1/8	
TAFM2550F32	●	25.5	3	2	76.5	85	100	155	32	42	PT1/8	GPMT090304-U○
TAFS2600F32	●		2		52	62	77	132	32	42	PT1/8	
TAFM2600F32	●	26.0	3	2	78	88	103	158	32	42	PT1/8	GPMT090304-U○
TAFL2600F32	●		4		104	114	129	184	32	42	PT1/8	

TAFS, TAFM, TAFL

Order number	Stock	DC	L/D	ZNF	LU	LBX	LPR	OAL	DCON	DCSFMX	CNT	Insert
TAFS2650F32	●		2		53	62	77	132	32	42	PT1/8	
TAFM2650F32	●	26.5	3	2	79.5	88	103	158	32	42	PT1/8	GPMT090304-U○
TAFL2650F32	●		4		106	114	129	184	32	42	PT1/8	
TAFS2700F32	●		2		54	65	79	134	32	42	PT1/8	
TAFM2700F32	●	27.0	3	2	81	92	106	161	32	42	PT1/8	GPMT090304-U○
TAFL2700F32	●		4		108	119	133	188	32	42	PT1/8	
TAFS2750F32	●		2		55	65	79	134	32	42	PT1/8	
TAFM2750F32	●	27.5	3	2	82.5	92	106	161	32	42	PT1/8	GPMT090304-U○
TAFS2800F32	●		2		56	67	81	136	32	42	PT1/8	
TAFM2800F32	●	28.0	3	2	84	95	109	164	32	42	PT1/8	GPMT11T308-U○
TAFL2800F32	●		4		112	123	137	192	32	42	PT1/8	
TAFS2850F32	●		2		57	67	81	136	32	42	PT1/8	
TAFM2850F32	●	28.5	3	2	85.5	95	109	164	32	42	PT1/8	GPMT11T308-U○
TAFL2850F40	●		4		114	123	137	202	40	50	PT1/8	
TAFS2900F32	●		2		58	70	83	138	32	42	PT1/8	
TAFM2900F32	●	29.0	3	2	87	99	112	167	32	42	PT1/8	GPMT11T308-U○
TAFL2900F32	●		4		116	128	141	196	32	42	PT1/8	
TAFS2950F32	●		2		59	70	83	138	32	42	PT1/8	
TAFM2950F32	●	29.5	3	2	88.5	99	112	167	32	42	PT1/8	GPMT11T308-U○
TAFS3000F32	●		2		60	72	90	145	32	50	PT1/8	
TAFS3000F40	●		2		60	72	90	155	40	50	PT1/4	
TAFM3000F32	●	30.0	3	2	90	102	120	175	32	50	PT1/8	GPMT11T308-U○
TAFM3000F40	●		3		90	102	120	185	40	50	PT1/4	
TAFL3000F32	●		4		120	132	150	205	32	42	PT1/8	
TAFL3000F40	●		4		120	132	150	215	40	50	PT1/4	
TAFS3050F40	●	30.5	2	2	61	72	90	155	40	50	PT1/4	GPMT11T308-U○
TAFM3050F40	●		3		91.5	102	120	185	40	50	PT1/4	
TAFS3100F32	●		2		62	74	92	147	32	50	PT1/8	
TAFS3100F40	●		2		62	74	92	157	40	50	PT1/4	
TAFM3100F32	●	31.0	3	2	93	105	123	178	32	50	PT1/8	GPMT11T308-U○
TAFM3100F40	●		3		93	105	123	188	40	50	PT1/4	
TAFL3100F32	●		4		124	135	154	209	32	42	PT1/8	
TAFL3100F40	●		4		124	136	154	219	40	50	PT1/4	
TAFS3200F32	●		2		64	77	94	149	32	50	PT1/8	
TAFS3200F40	●		2		64	77	94	159	40	50	PT1/4	
TAFM3200F32	●	32.0	3	2	96	109	126	181	32	50	PT1/8	GPMT11T308-U○
TAFM3200F40	●		3		96	109	126	191	40	50	PT1/4	
TAFL3200F32	●		4		128	141	158	213	32	42	PT1/8	
TAFL3200F40	●		4		128	141	158	223	40	50	PT1/4	
TAFS3300F32	●		2		66	79	96	151	32	50	PT1/8	
TAFS3300F40	●		2		66	79	96	161	40	50	PT1/4	
TAFM3300F32	●	33.0	3	2	99	112	129	184	32	50	PT1/8	GPMT11T308-U○
TAFM3300F40	●		3		99	112	129	194	40	50	PT1/4	
TAFL3300F32	●		4		132	145	162	217	32	42	PT1/8	
TAFL3300F40	●		4		132	145	162	227	40	50	PT1/4	
TAFS3400F32	●		2		68	82	98	153	32	50	PT1/8	
TAFS3400F40	●		2		68	82	98	163	40	50	PT1/4	
TAFM3400F32	●	34.0	3	2	102	116	132	187	32	50	PT1/8	GPMT11T308-U○
TAFM3400F40	●		3		102	116	132	197	40	50	PT1/4	
TAFL3400F32	●		4		136	150	166	231	32	42	PT1/8	
TAFL3400F40	●		4		136	150	166	231	40	50	PT1/4	

TAFS, TAFM, TAFL

Order number	Stock	DC	L/D	ZNF	LU	LBX	LPR	OAL	DCON	DCSFMX	CNT	Insert
TAFS3500F32	●	35.0	2	2	70	84	100	155	32	50	PT1/8	GPMT140408-U○
TAFS3500F40	●		2		70	84	100	165	40	50	PT1/4	
TAFM3500F32	●		3		105	119	135	190	32	50	PT1/8	
TAFM3500F40	●		3		105	119	135	200	40	50	PT1/4	
TAFL3500F32	●		4		140	154	170	235	32	42	PT1/8	
TAFL3500F40	●		4		140	154	170	235	40	50	PT1/4	
TAFS3600F32	□	36.0	2	2	72	86	102	157	32	50	PT1/8	GPMT140408-U○
TAFS3600F40	□		2		72	86	102	167	40	50	PT1/4	
TAFM3600F32	□		3		108	122	138	193	32	50	PT1/8	
TAFM3600F40	□		3		108	122	138	203	40	50	PT1/4	
TAFL3600F32	□		4		144	158	174	229	32	42	PT1/8	
TAFL3600F40	□		4		144	158	174	239	40	50	PT1/4	
TAFS3700F32	□	37.0	2	2	74	89	104	159	32	50	PT1/8	GPMT140408-U○
TAFS3700F40	□		2		74	89	104	169	40	50	PT1/4	
TAFM3700F32	□		3		111	126	141	196	32	50	PT1/8	
TAFM3700F40	□		3		111	126	141	206	40	50	PT1/4	
TAFL3700F32	□		4		148	163	178	233	32	42	PT1/8	
TAFL3700F40	□		4		148	163	178	243	40	50	PT1/4	
TAFS3750F32	□	37.5	2	2	75	89	104	159	32	50	PT1/8	GPMT140408-U○
TAFS3750F40	□		2		75	89	104	169	40	50	PT1/4	
TAFM3750F32	□		3		112.5	126	141	196	32	50	PT1/8	
TAFM3750F40	□		3		112.5	126	141	206	40	50	PT1/4	
TAFL3750F32	□		4		150	163	178	233	32	42	PT1/8	
TAFL3750F40	□		4		150	163	178	243	40	50	PT1/4	
TAFS3800F32	□	38.0	2	2	76	91	106	161	32	50	PT1/8	GPMT140408-U○
TAFS3800F40	□		2		76	91	106	171	40	50	PT1/4	
TAFM3800F32	□		3		114	129	144	199	32	50	PT1/8	
TAFM3800F40	□		3		114	129	144	209	40	50	PT1/4	
TAFL3800F32	□		4		152	167	182	247	32	42	PT1/8	
TAFL3800F40	□		4		152	167	182	247	40	50	PT1/4	
TAFS3900F32	□	39.0	2	2	78	94	108	163	32	50	PT1/8	GPMT140408-U○
TAFS3900F40	□		2		78	94	108	173	40	50	PT1/4	
TAFM3900F32	□		3		117	133	147	202	32	50	PT1/8	
TAFM3900F40	□		3		117	133	147	212	40	50	PT1/4	
TAFL3900F32	□		4		156	172	186	251	32	42	PT1/8	
TAFL3900F40	□		4		156	172	186	251	40	50	PT1/4	
TAFS4000F32	□	40.0	2	2	80	96	110	165	32	50	PT1/8	GPMT140408-U○
TAFS4000F40	□		2		80	96	110	175	40	50	PT1/4	
TAFM4000F32	□		3		120	136	150	205	32	50	PT1/8	
TAFM4000F40	□		3		120	136	150	215	40	50	PT1/4	
TAFL4000F32	□		4		160	176	190	245	32	42	PT1/8	
TAFL4000F40	□		4		160	176	190	255	40	50	PT1/4	
TAFS4100F40	□	41.0	2	2	82	98	112	177	40	50	PT1/4	GPMT140408-U○
TAFM4100F40	□		3		123	139	153	218	40	50	PT1/4	
TAFL4100F40	□		4		164	180	194	259	40	50	PT1/4	
TAFS4200F40	□	42.0	2	2	84	101	114	179	40	50	PT1/4	GPMT140408-U○
TAFM4200F40	□		3		126	143	156	221	40	50	PT1/4	
TAFL4200F40	□	4	168	185	198	263	40	50	PT1/4			
TAFS4300F40	□	43.0	2	2	86	103	116	181	40	50	PT1/4	GPMT140408-U○
TAFM4300F40	□		3		129	146	159	224	40	50	PT1/4	
TAFL4300F40	□		4		172	189	202	267	40	50	PT1/4	

TAFS, TAFM, TAFL

Order number	Stock	DC	L/D	ZNF	LU	LBX	LPR	OAL	DCON	DCSFMX	CNT	Insert
TAFS4400F40	<input type="checkbox"/>		2		88	106	118	183	40	50	PT1/4	
TAFM4400F40	<input type="checkbox"/>	44.0	3	2	132	150	162	227	40	50	PT1/4	GPMT140408-U
TAFL4400F40	<input type="checkbox"/>		4		176	194	206	271	40	50	PT1/4	
TAFS4500F40	<input type="checkbox"/>		2		90	108	120	185	40	54	PT1/4	
TAFM4500F40	<input type="checkbox"/>	45.0	3	2	135	153	165	230	40	54	PT1/4	GPMT140408-U
TAFL4500F40	<input type="checkbox"/>		4		180	198	210	275	40	54	PT1/4	
TAFS4600F40	<input type="checkbox"/>		2		92	110	122	187	40	54	PT1/4	
TAFM4600F40	<input type="checkbox"/>	46.0	3	2	138	156	168	233	40	54	PT1/4	GPMT140408-U
TAFL4600F40	<input type="checkbox"/>		4		184	202	214	279	40	54	PT1/4	
TAFS4700F40	<input type="checkbox"/>		2		94	113	124	189	40	54	PT1/4	
TAFM4700F40	<input type="checkbox"/>	47.0	3	2	141	160	171	236	40	54	PT1/4	GPMT140408-U
TAFL4700F40	<input type="checkbox"/>		4		188	207	218	283	40	54	PT1/4	
TAFS4800F40	<input type="checkbox"/>		2		96	115	126	191	40	54	PT1/4	
TAFM4800F40	<input type="checkbox"/>	48.0	3	2	144	163	174	239	40	54	PT1/4	GPMT140408-U
TAFL4800F40	<input type="checkbox"/>		4		192	211	222	287	40	54	PT1/4	
TAFS4900F40	<input type="checkbox"/>		2		98	118	133	198	40	58	PT1/4	
TAFM4900F40	<input type="checkbox"/>	49.0	3	4	147	167	182	247	40	58	PT1/4	GPMT090304-U
TAFL4900F40	<input type="checkbox"/>		4		196	216	231	296	40	58	PT1/4	
TAFS5000F40	<input type="checkbox"/>		2		100	120	135	200	40	58	PT1/4	
TAFM5000F40	<input type="checkbox"/>	50.0	3	4	150	170	185	250	40	58	PT1/4	GPMT090304-U
TAFL5000F40	<input type="checkbox"/>		4		200	220	235	300	40	58	PT1/4	
TAFS5100F40	<input type="checkbox"/>		2		102	122	137	202	40	58	PT1/4	
TAFM5100F40	<input type="checkbox"/>	51.0	3	4	153	173	188	253	40	58	PT1/4	GPMT090304-U
TAFL5100F40	<input type="checkbox"/>		4		204	224	239	304	40	58	PT1/4	
TAFS5200F40	<input type="checkbox"/>		2		104	125	139	204	40	58	PT1/4	
TAFM5200F40	<input type="checkbox"/>	52.0	3	4	156	177	191	256	40	58	PT1/4	GPMT090304-U
TAFL5200F40	<input type="checkbox"/>		4		208	229	243	308	40	58	PT1/4	
TAFS5300F40	<input type="checkbox"/>		2		106	127	141	206	40	63	PT1/4	
TAFM5300F40	<input type="checkbox"/>	53.0	3	4	159	180	194	259	40	63	PT1/4	GPMT090304-U
TAFL5300F40	<input type="checkbox"/>		4		212	233	247	312	40	63	PT1/4	
TAFS5400F40	<input type="checkbox"/>		2		108	128	143	208	40	63	PT1/4	
TAFM5400F40	<input type="checkbox"/>	54.0	3	4	162	182	197	262	40	63	PT1/4	GPMT090304-U
TAFL5400F40	<input type="checkbox"/>		4		216	236	251	316	40	63	PT1/4	
TAFS5500F40	<input type="checkbox"/>		2		110	130	145	210	40	63	PT1/4	
TAFM5500F40	<input type="checkbox"/>	55.0	3	4	165	185	200	265	40	63	PT1/4	GPMT090304-U
TAFL5500F40	<input type="checkbox"/>		4		220	240	255	320	40	63	PT1/4	
TAFS5600F40	<input type="checkbox"/>		2		112	132	147	212	40	63	PT1/4	
TAFM5600F40	<input type="checkbox"/>	56.0	3	4	168	188	203	268	40	63	PT1/4	GPMT090304-U
TAFL5600F40	<input type="checkbox"/>		4		224	244	259	324	40	63	PT1/4	

TAFS, TAFM, TAFL

INCREASED RIGIDITY TYPE DESIGN

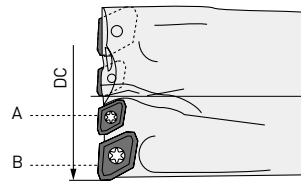
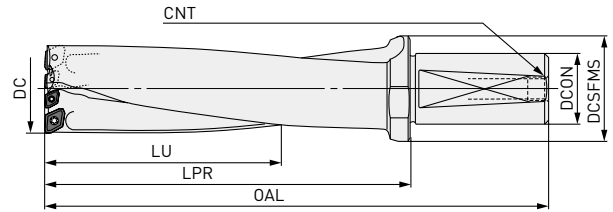
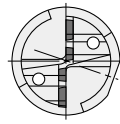

Order number	Stock	DC	L/D	ZNF	DCON	DCSFMS	CNT	OAL	LPR	LU	Inner/ Outer type	Insert
TAFS5000F40-E	<input type="checkbox"/>		2	4	40	58	PT1/4	200	135	120	A B	GPMT090304-U \odot GPMT11T308-U \odot
TAFM5000F40-E	<input type="checkbox"/>	50.0	3	4	40	58	PT1/4	250	185	170	A B	GPMT090304-U \odot GPMT11T308-U \odot
TAFL5000F40-E	<input type="checkbox"/>		4	4	40	58	PT1/4	300	235	220	A B	GPMT090304-U \odot GPMT11T308-U \odot
TAFS5100F40-E	<input type="checkbox"/>		2	4	40	58	PT1/4	202	137	122	A B	GPMT090304-U \odot GPMT11T308-U \odot
TAFM5100F40-E	<input type="checkbox"/>	51.0	3	4	40	58	PT1/4	253	188	173	A B	GPMT090304-U \odot GPMT11T308-U \odot
TAFL5100F40-E	<input type="checkbox"/>		4	4	40	58	PT1/4	304	239	224	A B	GPMT090304-U \odot GPMT11T308-U \odot
TAFS5200F40-E	<input type="checkbox"/>		2	4	40	58	PT1/4	204	139	125	A B	GPMT090304-U \odot GPMT11T308-U \odot
TAFM5200F40-E	<input type="checkbox"/>	52.0	3	4	40	58	PT1/4	256	191	177	A B	GPMT090304-U \odot GPMT11T308-U \odot
TAFL5200F40-E	<input type="checkbox"/>		4	4	40	58	PT1/4	308	243	229	A B	GPMT090304-U \odot GPMT11T308-U \odot
TAFS5300F40-E	<input type="checkbox"/>		2	4	40	63	PT1/4	206	141	127		
TAFM5300F40-E	<input type="checkbox"/>	53.0	3	4	40	63	PT1/4	259	194	180	A	GPMT11T308-U \odot
TAFL5300F40-E	<input type="checkbox"/>		4	4	40	63	PT1/4	312	247	233		
TAFS5400F40-E	<input type="checkbox"/>		2	4	40	63	PT1/4	208	134	128		
TAFM5400F40-E	<input type="checkbox"/>	54.0	3	4	40	63	PT1/4	262	197	182	A	GPMT11T308-U \odot
TAFL5400F40-E	<input type="checkbox"/>		4	4	40	63	PT1/4	316	251	236		
TAFS5500F40-E	<input type="checkbox"/>		2	4	40	63	PT1/4	210	145	130		
TAFM5500F40-E	<input type="checkbox"/>	55.0	3	4	40	63	PT1/4	265	200	185	A	GPMT11T308-U \odot
TAFL5500F40-E	<input type="checkbox"/>		4	4	40	63	PT1/4	320	255	240		
TAFS5600F40-E	<input type="checkbox"/>		2	4	40	63	PT1/4	212	147	132		
TAFM5600F40-E	<input type="checkbox"/>	56.0	3	4	40	63	PT1/4	268	203	188	A	GPMT11T308-U \odot
TAFL5600F40-E	<input type="checkbox"/>		4	4	40	63	PT1/4	324	259	244		

TAFS, TAFM, TAFL

SPARE PARTS

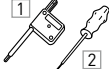
Tool holder type		
	Clamp screw	Wrench
GCMT040204-U \odot	TS2	1 TKY06F
GPMT060204-U \odot	TS2	1 TKY06F
GPMT070204-U \odot	TS25	1 TKY08F
GPMT090304-U \odot	TS3	1 TKY08F
GPMT11T308-U \odot	TS4	2 TKY15D
GPMT140408-U \odot	TS5	2 TKY25D
GPMT090304-U \odot	TS3	1 TKY08F

INSERTS

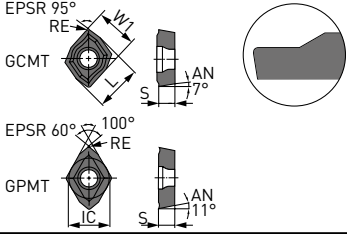
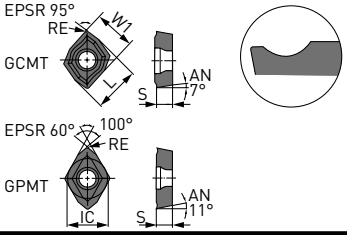
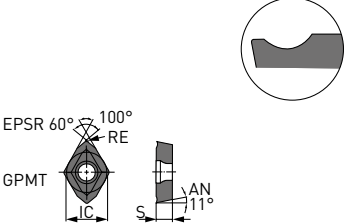
Order number	VP15TF	UP20M	GP20M	UE6020	US735	L	W1	IC	S	RE	Drill diameter	Shape
U1												
GCMT040204-U1	●					5.0	4.7	—	2.38	0.4	∅ 12 – 14.5	
GPMT060204-U1	●	●		●	●	—	—	5.56	2.38	0.4	∅ 15 – 17.5	
GPMT070204-U1	●	●		●	●	—	—	6.35	2.38	0.4	∅ 18 – 22.5	
GPMT090304-U1	●	●		●	●	—	—	7.94	3.18	0.4	∅ 23 – 27.5	
GPMT090304-U1	●	●		●	●	—	—	7.94	3.18	0.4	∅ 49 – 56	
GPMT11T308-U1	●	●		●	●	—	—	9.525	3.97	0.8	∅ 28 – 34	
GPMT140408-U1	●	●		●	●	—	—	12.70	4.76	0.8	∅ 35 – 48	
U2												
GCMT040204-U2	●		●			5.0	4.7	—	2.38	0.4	∅ 12 – 14.5	
GPMT060204-U2	●	●		●	●	—	—	5.56	2.38	0.4	∅ 15 – 17.5	
GPMT070204-U2	●	●		●	●	—	—	6.35	2.38	0.4	∅ 18 – 22.5	
GPMT090304-U2	●	●		●	●	—	—	7.94	3.18	0.4	∅ 23 – 27.5	
GPMT090304-U2	●	●		●	●	—	—	7.94	3.18	0.4	∅ 49 – 56	
GPMT11T308-U2	●	●		●	●	—	—	9.525	3.97	0.8	∅ 28 – 34	
GPMT140408-U2	●	●		●	●	—	—	12.70	4.76	0.8	∅ 35 – 48	
U3												
GPMT060204-U3	●			●	●	—	—	5.56	2.38	0.4	∅ 15 – 17.5	
GPMT070204-U3	●			●	●	—	—	6.35	2.38	0.4	∅ 18 – 22.5	
GPMT090304-U3	●			●	●	—	—	7.94	3.18	0.4	∅ 23 – 27.5	
GPMT090304-U3	●			●	●	—	—	7.94	3.18	0.4	∅ 49 – 56	
GPMT11T308-U3	●			●	●	—	—	9.525	3.97	0.8	∅ 28 – 34	
GPMT140408-U3	●			●	●	—	—	12.70	4.76	0.8	∅ 35 – 48	

TAFS, TAFM, TAFL

INSERT RECOMMENDATION

CHIPBREAKER RECOMMENDATION

Material	1st recommendation		2nd recommendation	
	GCMT	GPMT	GCMT	GPMT
		U1	U1	
P Mild steel			U2	U2
				U3
			U1	U1
				U2
Carbon steel Alloy steel Alloy tool steel	U2	U2		U2
				U3
			U1	U1
M Stainless steel	U2	U2		
				U3
			U1	U1
K Gray cast iron Ductile cast iron	U2	U3		
				U2

INSERT GRADE RECOMMENDATION

Material	Grade			
	1st recommendation		2nd recommendation	
	GCMT	GPMT	GCMT	GPMT
P Mild steel			VP15TF	VP15TF
	UP20M	UP20M		
			GP20M	
				UE6020
				US735
Carbon steel Alloy steel Alloy tool steel	VP15TF	VP15TF		
			UP20M	UP20M
	GP20M	UE6020	GP20M	VP15TF
				US735
M Stainless steel	VP15TF	VP15TF		
			UP20M	UP20M
	GP20M	US735	GP20M	
				UE6020
K Gray cast iron Ductile cast iron	VP15TF			
			UP20M	UP20M
	GP20M			UE6020
				US735
			VP15TF	

TAFS, TAFM, TAFL

RECOMMENDED CUTTING CONDITIONS

Material	Hardness	Vc				Vc					
		L/D = 2, 3		L/D = 4		Drill diameter					
		Ø 12 - Ø 14.5	Ø 15 -	Ø 16 -		Ø 12 - Ø 14.5	Ø 15 - Ø 22.5	Ø 23 - Ø 34	Ø 35 - Ø 48	Ø 49 - Ø 56	
P	Mild steel	≤180HB	150 (100-200)	200 (150-300)	140 (100-200)	U1	0.06 (0.04-0.10)	0.07 (0.04-0.10)	0.08 (0.04-0.10)	0.10 (0.04-0.12)	0.08 (0.04-0.10)
						U2	0.06 (0.04-0.10)	0.08 (0.04-0.12)	0.10 (0.04-0.12)	0.12 (0.04-0.14)	0.10 (0.04-0.12)
						U3	—	0.08 (0.04-0.12)	0.10 (0.04-0.12)	0.12 (0.04-0.14)	0.10 (0.04-0.12)
	Carbon steel	180-280 HB	120 (80-160)	150 (120-180)	100 (80-120)	U1	0.06 (0.04-0.10)	0.09 (0.06-0.12)	0.12 (0.08-0.14)	0.15 (0.08-0.18)	0.12 (0.08-0.14)
						U2	0.06 (0.04-0.10)	0.12 (0.06-0.14)	0.14 (0.08-0.18)	0.17 (0.08-0.20)	0.14 (0.08-0.18)
						U3	—	0.12 (0.06-0.14)	0.14 (0.08-0.18)	0.17 (0.08-0.20)	0.14 (0.08-0.18)
	Alloy steel	180-280 HB	120 (80-160)	150 (120-180)	100 (80-120)	U1	0.06 (0.04-0.10)	0.08 (0.06-0.10)	0.09 (0.06-0.12)	0.11 (0.06-0.14)	0.09 (0.06-0.12)
						U2	0.06 (0.04-0.10)	0.10 (0.06-0.12)	0.12 (0.08-0.16)	0.14 (0.08-0.18)	0.12 (0.08-0.16)
						U3	—	0.10 (0.06-0.12)	0.12 (0.08-0.16)	0.14 (0.08-0.18)	0.12 (0.08-0.16)
M	Stainless steel	≤200HB	100 (80-120)	150 (120-200)	110 (80-140)	U1	0.07 (0.04-0.10)	0.07 (0.04-0.10)	0.08 (0.04-0.10)	0.10 (0.04-0.12)	0.08 (0.04-0.10)
						U2	0.07 (0.04-0.10)	0.08 (0.04-0.12)	0.10 (0.04-0.14)	0.12 (0.04-0.16)	0.10 (0.04-0.14)
						U3	—	0.08 (0.04-0.12)	0.10 (0.04-0.14)	0.12 (0.04-0.16)	0.10 (0.04-0.14)
K	Cast iron	Tensile strength ≤350MPa	120 (80-160)	150 (120-180)	140 (110-160)	U1	0.07 (0.06-0.10)	0.07 (0.06-0.10)	0.10 (0.04-0.14)	0.10 (0.06-0.14)	0.10 (0.06-0.14)
						U2	0.07 (0.06-0.10)	0.15 (0.10-0.18)	0.20 (0.10-0.25)	0.20 (0.10-0.25)	0.20 (0.10-0.25)
						U3	—	0.15 (0.10-0.18)	0.20 (0.10-0.25)	0.20 (0.10-0.25)	0.20 (0.10-0.25)
	Ductile cast iron	Tensile strength ≤450MPa	120 (80-150)	150 (120-180)	100 (80-120)	U1	0.06 (0.04-0.10)	0.07 (0.06-0.10)	0.10 (0.06-0.14)	0.10 (0.06-0.14)	0.10 (0.06-0.14)
						U2	0.06 (0.04-0.10)	0.12 (0.08-0.14)	0.15 (0.08-0.20)	0.18 (0.08-0.20)	0.15 (0.08-0.20)
						U3	—	0.12 (0.08-0.14)	0.15 (0.08-0.20)	0.18 (0.08-0.20)	0.15 (0.08-0.20)

1. When using drills for l/d= 4, the feed should be reduced to 80 % of the above recommendations.

TAFS, TAFM, TAFL

JUST FIT SLEEVE [JFS]

A sleeve for the shank of the drill to allow the cutting diameter to be increased.

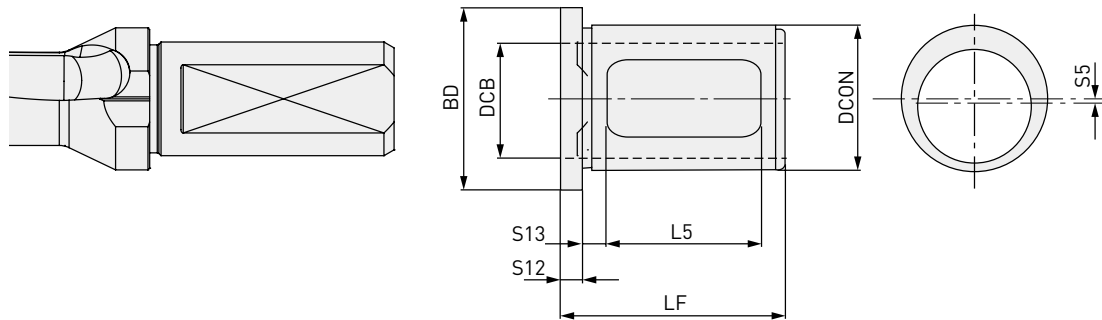

Order number	Set order number	Stock	DCB	DCON	BD	LF	L5	* Increase (S5×2)	Suitable TAF type drill
JFS2520-10	JFS-1	●	20	25	33	43	30	0.1	TAFS/M/L1200F20 - TAFS/M/L1550F20
JFS2520-20		●	20	25	33	43	30	0.2	
JFS2520-30		●	20	25	33	43	30	0.3	
JFS2520-40		●	20	25	33	43	30	0.4	
JFS2520-50		●	20	25	33	43	30	0.5	
JFS3225-10	JFS-2	●	25	32	40	50	34	0.1	TAFS/M/L1600F25 - TAFS/M/L2450F25
JFS3225-20		●	25	32	40	50	34	0.2	
JFS3225-30		●	25	32	40	50	34	0.3	
JFS3225-40		●	25	32	40	50	34	0.4	
JFS3225-50		●	25	32	40	50	34	0.5	
JFS4032-10	JFS-3	●	32	40	48	55	40	0.1	TAFS/M/L2500F32 - TAFS/M/L2950F32
JFS4032-20		●	32	40	48	55	40	0.2	
JFS4032-30		●	32	40	48	55	40	0.3	
JFS4032-40		●	32	40	48	55	40	0.4	
JFS4032-50		●	32	40	48	55	40	0.5	
JFS5040-10	JFS-4	●	40	50	68	65	50	0.1	AFS/M/L2850F40 - TAFS/M/L5600F40 TAFS/M/L5000F40-E
JFS5040-20		●	40	50	68	65	50	0.2	
JFS5040-30		●	40	50	68	65	50	0.3	
JFS5040-40		●	40	50	68	65	50	0.4	
JFS5040-50		●	40	50	68	65	50	0.5	

* Increase: Size of the increased cutting diameter.

TAFS, TAFM, TAFL

GUIDELINE FOR SELECTING A JUST FIT SLEEVE

Desired = (Drill Ø + Increase of JFS) + 0.1 mm

(Eg.) Desired diameter is 20.3 mm (oversize is taken as 0.1 mm).

$$\text{Ø } 20.3 = (\text{TAFS/M/L2000F25} + \text{JFS3225-20}) + 0.1$$

⋮
20 mm Drill

⋮
Using JFS an increase
of 0.2 mm

⋮
Oversize

Tool selected

Drill: TAFM2000F25

Just Fit Sleeve [JFS]: JFS3225-20

1. Oversize can vary due to the cutting conditions used, please use the above as a guideline.

ORDERING THE JUST FIT SLEEVE

PURCHASING METHOD 1

Oversize can vary due to the cutting conditions used. Therefore it is recommended to purchase as a set. When placing an order, please use the Set order number. (5 sleeves/set)

PURCHASING METHOD 2

It is possible to order individually. When placing an order, please use the individual order number.

APPLICATION OF JUST FIT SLEEVE

When inserting the drill into the side lock holder, align the V groove on the outer peripheral edge of the drill flange, as well as the round holes of the outer peripheral edge of the sleeve flange and the screws of the side lock holder for fixing the drill. (If the drill does not have a V groove, align the notch of the drill shank with the round holes of the sleeve.)

Insert screws A of the side lock holder directly to the open window of the sleeve and fix the drill. Tighten screw B to a degree so as not to damage the sleeve.

- Fine adjustments cannot be made for the diameter of the sleeve.
- Cannot be used with collect chuck type holders.

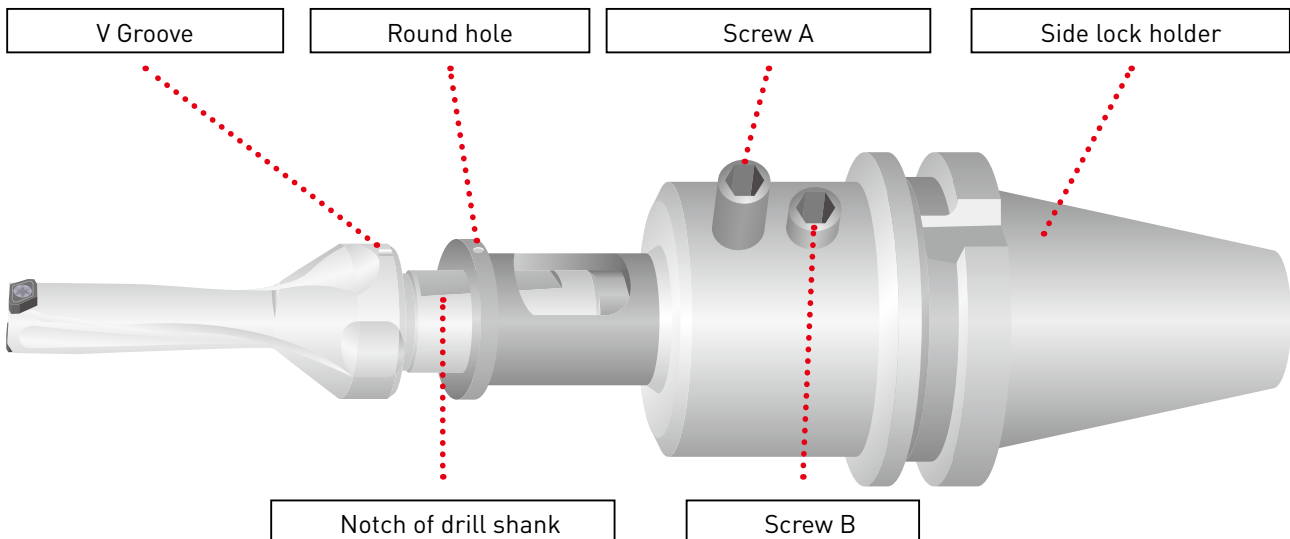

TAFS, TAFM, TAFL

APPLICATION EXAMPLES

ANGLED FACE DRILLING

Material	DIN 42CrMo4 (180 – 280 HB)
Tool	Ø 20 (3 x D)
Vc (m/min)	80
f (mm/rev)	0.08

Tool	L (mm)	L (max.)
TAF	0.11	Good
Conventional A	0.17	Good
Conventional B	0.13	Inner and outer cutting edge fractures

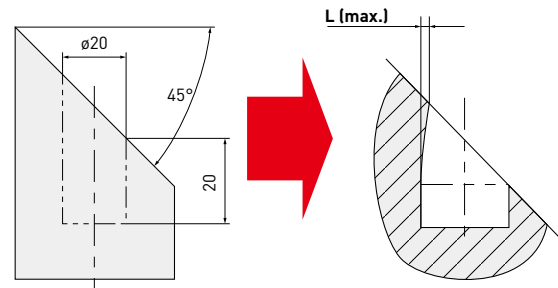

ROUND WORKPIECE DRILLING

Material	DIN Ck50 (120 HB – 180 HB)
Tool	Ø 20 (3 x D)
Vc (m/min)	50, 80, 100
f (mm/rev)	0.08 Initial cutting 0.05

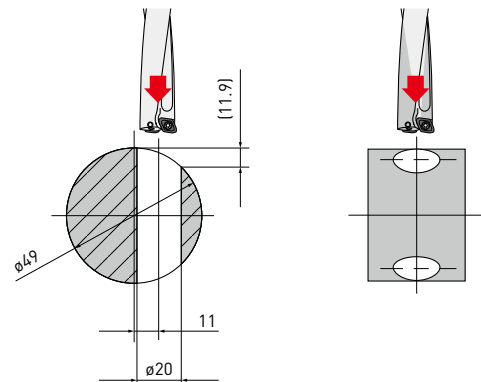

1. The inner cutting edge of a competitors drill fractured.

THROUGHHOLE DRILLING

Material	DIN Ck50 (120 – 180 HB)
Tool	Ø 20 (3 x D)
Vc (m/min)	80
f (mm/rev)	0.08

Drill oversize (to measured drill diameter)

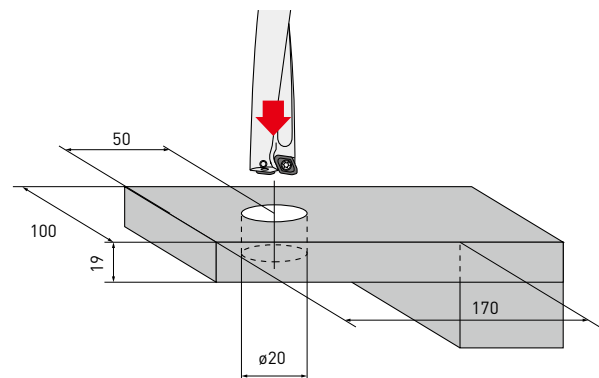
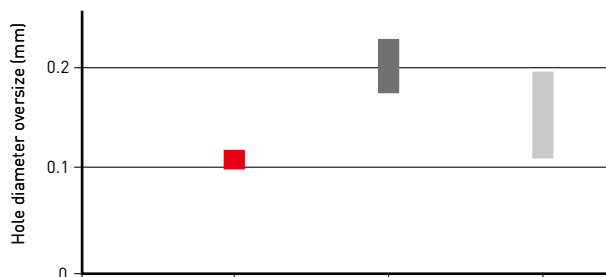

TAFS, TAFM, TAFL

APPLICATIONS

- Please ensure the highest rigidity possible exists in both machine set up and workholding.
- Refer to the following graph on the right for coolant pressure and volume. Coolant is an important factor in the efficient use of these drills.
- Cannot be used for stack drilling.
In common with many indexable insert drills, these drills produce a round disc on exit which unless evacuated may cause the drill to fracture.

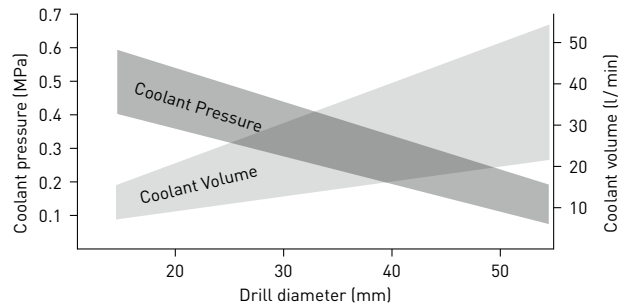

USE ON A LATHE

The inner cutting edge must be positioned between 0–0.2 mm over center.

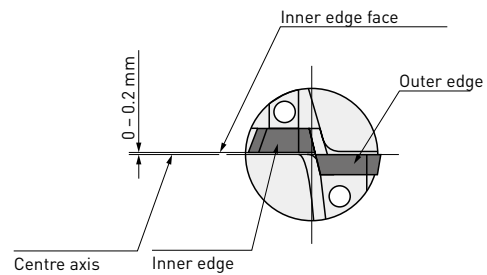

To adjust the hole diameter by off-setting the drill, the outer cutting edge and machine axis must be set parallel.

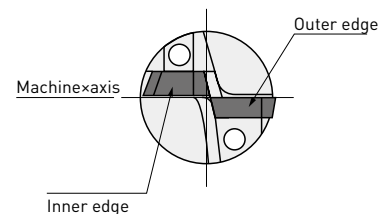

When producing an oversize hole.

The drill offset should be no more than 2 % of the diameter. It is not possible to produce an undersized hole.

When through hole drilling on a lathe the disc produced by the drill exiting the workpiece may be expelled at high velocity. To reduce the danger of injury or damage a cover guard is highly recommended.

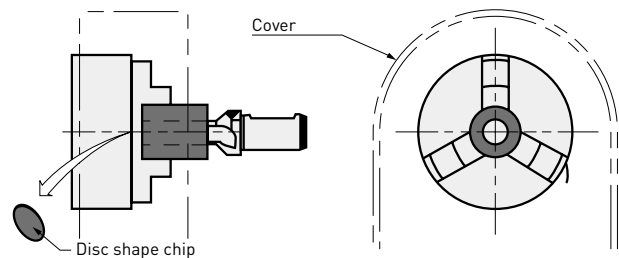

WORLDWIDE

MITSUBISHI MATERIALS CORPORATION - METALWORKING SOLUTIONS COMPANY A SYNERGY FOR SUCCESS

The Metalworking Solutions division of Mitsubishi Materials is dedicated to the development and processing of metals, cutting materials, coatings and precision tools. Profound know-how and many years of experience in manufacturing technology makes Mitsubishi Materials one of the leading suppliers in the precision cutting tool market.

The company's global market presence, with headquarters and sales offices in Japan, Europe, India, Brazil, China, Thailand, Mexico and the US, as well as a broad network of international distributors, ensures a targeted, comprehensive service.

Information exchange and technology transfer, open communication and growing synergies guarantee maximum performance and sustainable customer success.

METALWORKING SOLUTIONS COMPANY



- Sales Office
- Factory
- Distribution Centre
- Distributor
- Technical Education Centre (MTEC)



POLAND

U.K.

RUSSIA

JAPAN

CHINA

THAILAND

INDIA

TURKEY



GERMANY

MMC HARTMETALL GMBH
Comeniusstr. 2 . 40670 Meerbusch
Phone +49 2159 91890 . Fax +49 2159 918966
Email admin@mmchg.de

U.K.

MMC HARDMETAL U.K. LTD.
Mitsubishi House . Galena Close . Tamworth . Staffs. B77 4AS
Phone +44 1827 312312 . Fax +44 1827 312314
Email sales@mitsubishicarbide.co.uk

SPAIN

MITSUBISHI MATERIALS ESPAÑA, S.A.
Calle Emperador 2 . 46136 Museros/Valencia
Phone +34 96 1441711 . Fax +34 96 1443786
Email comercial@mmevalencia.es

FRANCE

MMC METAL FRANCE S.A.R.L.
6, Rue Jacques Monod . 91400 Orsay
Phone +33 1 69 35 53 53 . Fax +33 1 69 35 53 50
Email mmfsales@mmc-metal-france.fr

POLAND

MMC HARDMETAL POLAND SP. Z O.O
Al. Armii Krajowej 61 . 50 - 541 Wrocław
Phone +48 71335 1620 . Fax +48 71335 1621
Email sales@mitsubishicarbide.com.pl

RUSSIA

MMC HARDMETAL OOO LTD.
Electrozavodskaya St. 24 . build. 3 . Moscow . 107023
Phone +7 495 725 58 85 . Fax +7 495 981 39 79
Email info@mmc-carbide.ru

ITALY

MMC ITALIA S.R.L.
Viale Certosa 144 . 20156 Milano
Phone +39 0293 77031 . Fax +39 0293 589093
Email info@mmc-italia.it

TURKEY

MMC HARTMETALL GMBH ALMANYA - İZMİR MERKEZ ŞUBESİ
Adalet Mahallesi Anadolu Caddesi No: 41-1 . 15001 35530 Bayraklı / İzmir
Phone +90 232 5015000 . Fax +90 232 5015007
Email info@mmchg.com.tr

www.mmc-hardmetal.com

MP009E

Published: 2022.04 (6.0 DP), Printed in Germany