

KINTEK®

TURNING TOOLS - PORTAINSERTI



www.kintek.it

TURNING TOOLS 

PORTAINSERI 

KLEMMHALTER/BOHRSTANGEN 

PORTA-PLAQUITAS 

PORTE-PLAQUETTES 

ТОКАРНЫЙ ИНСТРУМЕНТ 

车刀 

ESTERNAL (O.D.) TURNING TOOLS

KLEMMHALTER FÜR DIE AUSSENBEARBEITUNG PORTA INSERTI PER ESTERNI
 PORTA-PLAQUITAS PARA EXTERIOR PORTA-PLAQUETTES EXTERIEURES
 ДЕРЖАВКИ ДЛЯ ВНЕШНЕГО ТОЧЕНИЯ 外部车刀

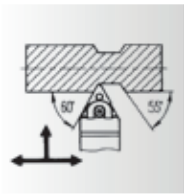

MTEN
Pag. 652

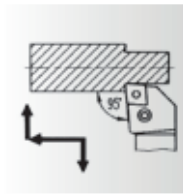

PCLN
Pag. 653

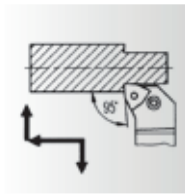

PWLN
Pag. 655

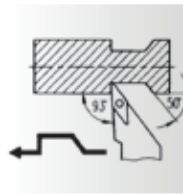

SVJB
Pag. 657

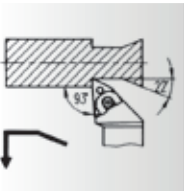

MTJN
Pag. 652

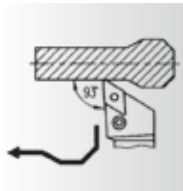

PDJN
Pag. 654

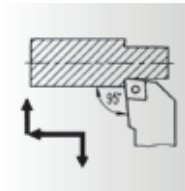

SCLC
Pag. 655



SVJC
Pag. 657

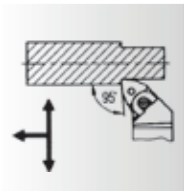

MWLN
Pag. 652

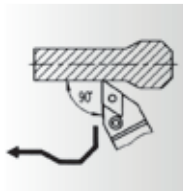

PDNN
Pag. 654

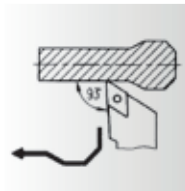

SDJC
Pag. 656

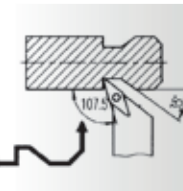

SVHB
Pag. 657

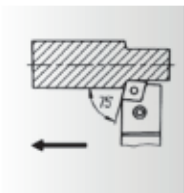

PCBN
Pag. 653

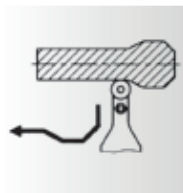

PRDC
Pag. 654

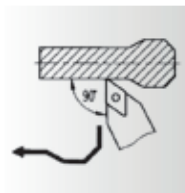

SDNC
Pag. 656

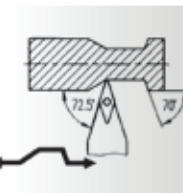

SVVB
Pag. 658

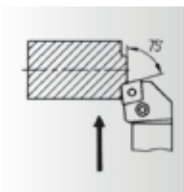

PCKN
Pag. 653

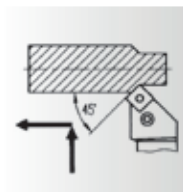

PSSN
Pag. 655

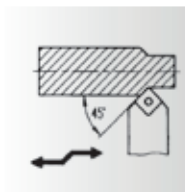

SSDC
Pag. 656

INTERNAL (I.D.) BORING BARS

BOHRSTANG FÜR INNENBEARBEITUNG BARENI PER INTERNI
 BARRAS DE MANDRINAR BARRES D'ALESAGE
 РАСТОЧНЫЕ ДЕРЖАВКИ 内部镗头

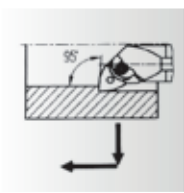

MWLN
Pag. 660

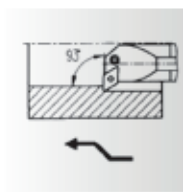

PDUN
Pag. 660

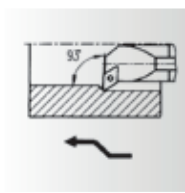

SDUC
Pag. 661

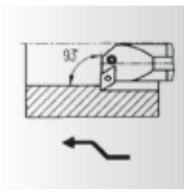

PCLN
Pag. 660

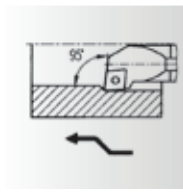

SCLC
Pag. 661

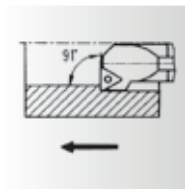

STFC
Pag. 661

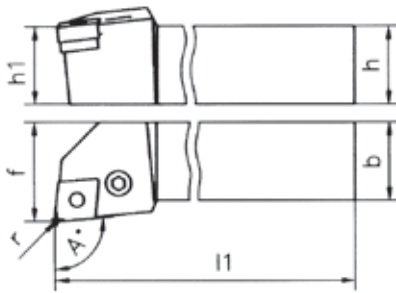
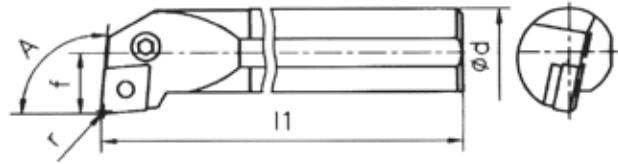
ISO5610 - External turning tools**ISO5610 - Per esterni****ISO5610 - Para exterior****ISO5610 - Aussenbearbeitung****ISO5609 - Internal turning tools****ISO5609 - Per interni****ISO5609 - Para interior****ISO5609 - Innenbearbeitung****KINTEK TURNING TOOLS****TECHNICAL DATAS****TOLERANCE**

h: h13
 b: h13
 d: g7
 f: +0/+0,5 (External)
 f: -0/-0,25 (Internal)
 l1: k16
 h1: js13

- 1 Turning tools for external and internal machining are produced of hardened steel with an hardness of 43 HRC.
- 2 The head of HM-Boring bars is made of hardened steel.
- 3 The face of turning tools for external is ground.

INSCRIBED CIRCLE OF THE INSERT	6,35	7,94	9,525	12,7	15,875	19,05	25,4
Radius r		0,4		0,8		1,2	2,4

**UTENSILI DI TORNITURA KINTEK****DATI TECNICI****TOLLERANZE**

h: h13
 b: h13
 d: g7
 f: +0/+0,5 (per esterni)
 f: -0/-0,25 (per interni)
 l1: k16
 h1: js13

- 1 Il materiale degli utensili per interni ed esterni è: acciaio bonificato, durezza 43 HRC.
- 2 La testa degli utensili in metallo duro è in acciaio bonificato.
- 3 Il piano di appoggio degli utensili per esterni è rettificato.

CERCHIO INSCRITTO DELL'INSERTO	6,35	7,94	9,525	12,7	15,875	19,05	25,4
Raggio r		0,4		0,8		1,2	2,4

**KINTEK DREHWERKZEUGE****TECHNISCHE DATEN****TOLERANZEN**

h: h13
 b: h13
 d: g7
 f: +0/+0,5 (Aussenbearbeitung)
 f: -0/-0,25 (Innenbearbeitung)
 l1: k16
 h1: js13

- 1 Die Klemmhalter und Bohrstangen werden aus Vergütungsstahl hergestellt, Harte 43 HRC.
- 2 Der Kopf der HM-Bohrstangen wird auch aus Vergütungsstahl produziert.
- 3 Die Auflagefläche aller Drehwerkzeuge ist geschliffen

INNENKREIS DER WSPLATTE	6,35	7,94	9,525	12,7	15,875	19,05	25,4
Radius r		0,4		0,8		1,2	2,4

**HERRAMIENTAS DE TORNEADO KINTEK****CARACTERISTICAS TECNICAS****TOLERANCIAS**

h: h13
 b: h13
 d: g7
 f: +0/+0,5 (para exterior)
 f: -0/-0,25 (para interior)
 l1: k16
 h1: js13

- 1 Las herramientas de torneado para mecanizado interior y exterior se producen en acero templado, con dureza 43 HRC.
- 2 La cabeza de las herramientas de metal duro está fabricada en acero templado.
- 3 El soporte de apoyo de las herramientas para exterior está rectificado

CIRCULO INSCRITO DE LA HERRAMIENTA	6,35	7,94	9,525	12,7	15,875	19,05	25,4
Radio r		0,4		0,8		1,2	2,4

ISO5610 - A usage externe

ISO5610 - Стандарт изготовления
наружных державок

ISO5610外部车刀

ISO5609 - A usage interieur

ISO5609 - Стандарт изготовления
расточных державок

ISO5609内部车刀

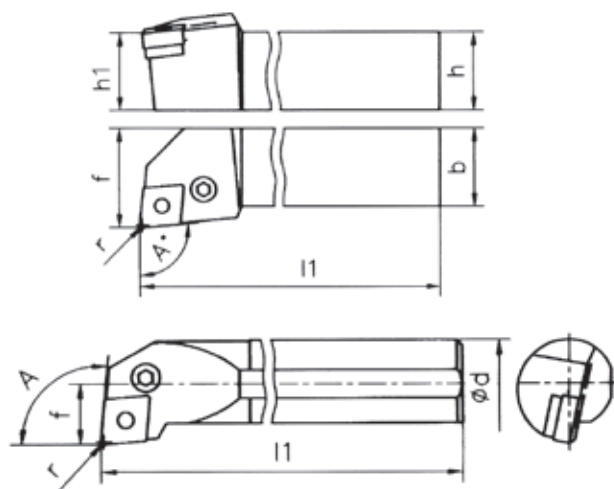

PORTE OUTILS DE TOURNAGE KINTEK

DONNEES TECHNIQUES

TOLERANCE

h: h13
b: h13
d: g7
f: +0/+0,5 (à usage externe)
f: -0/-0,25 (à usage interieur)
l1: k16
h1: js13

- 1 Le matériel utilisé pour les outils à usage externe et à usage interieur est: acier bonifié, dureté 43 HRC.
- 2 La tête des outils en carbure est fait en acier bonifié.
- 3 La partie plate des porte outils de tournage à usage externe est rectifié.

CERCLE INSCRIT DE LA PLAQUETTE	6,35	7,94	9,525	12,7	15,875	19,05	25,4
Rayon r	0,4		0,8		1,2		2,4



ТОКАРНЫЕ ДЕРЖАВКИ KINTEK

ТЕХНИЧЕСКИЕ ДАННЫЕ

ТОЧНОСТЬ

h: h13
b: h13
d: g7
f: +0/+0,5 (для наружных державок)
f: -0/-0,25 (для расточных державок)
l1: k16
h1: js13

- 1 Материал токарных державок для внешней и внутренней обработки – улучшенная сталь, твердость 43HRC.
- 2 Головки державок с твердосплавным хвостовиком сделаны также из улучшенной стали.
- 3 Торцы державок шлифованы.

ДИАМЕТР ВПИСАННОЙ ОКРУЖНОСТИ ПЛАСТИНЫ	6,35	7,94	9,525	12,7	15,875	19,05	25,4
Радиус r	0,4		0,8		1,2		2,4



KINTEK车刀

技术参数

公差

h: h13
b: h13
d: g7
f: +0/+0,5 (External)
f: -0/-0,25 (Internal)
l1: k16
h1: js13

- 1 车刀内部和外部均由硬度为43HRC的硬化刚加工制成。
- 2 HM镗头柄头部由硬化钢构成
- 3 车刀端面外部打磨

INSCRIBED CIRCLE OF THE INSERT	6,35	7,94	9,525	12,7	15,875	19,05	25,4
Radius r	0,4		0,8		1,2		2,4

IDENTIFICATION OF THE EXTERNAL (O.D.) TURNING TOOLS

BEZEICHNUNG VON KLEMMHALTERN FÜR DIE AUSSENBEARBEITUNG
IDENTIFICACION DE LOS PORTA-PLAQUITAS PARA EXTERIOR
ДЕРЖАВКИ ДЛЯ ВНЕШНЕГО ТОЧЕНИЯ

IDENTIFICAZIONE DEI PORTA INSERTI PER ESTERNI
DESIGNATION DES PORTE-PLAQUETTES EXTERIEURES
外部车刀 (O.D.) 识别

① M

Spannsystem
Clamping system
Système de serrage
Sistema di bloccaggio
Sistema de fijación
夹具系统

② W

Plattenform
Insert Shape
Forme des plaquettes
Forma degli inserti
Forma de la plaquita
插件形状

③ L

Austellwinkel
Shape of turning tools
Forme des porte-plaquettes
Forma dei portainseriti
Forma de los porta-plaquitas
车刀的形状

④ N

Freiwinkel
Clearance angle
Angle de depouil
Angolo di spoglio
Angulo de incidencia
间隙角度

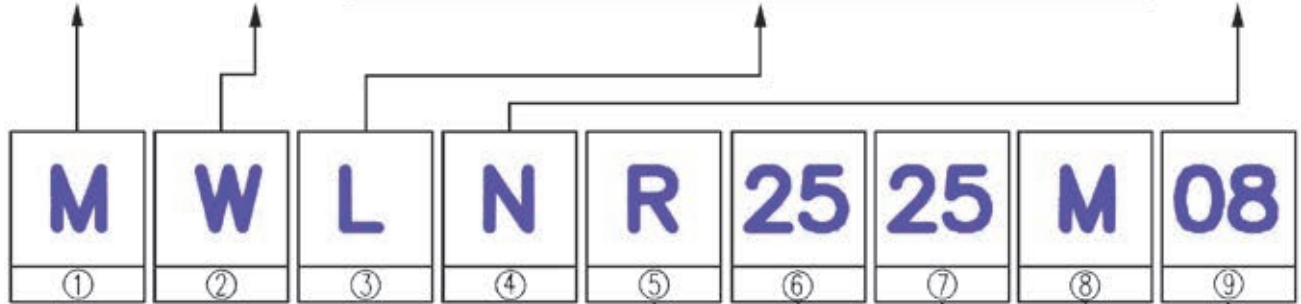
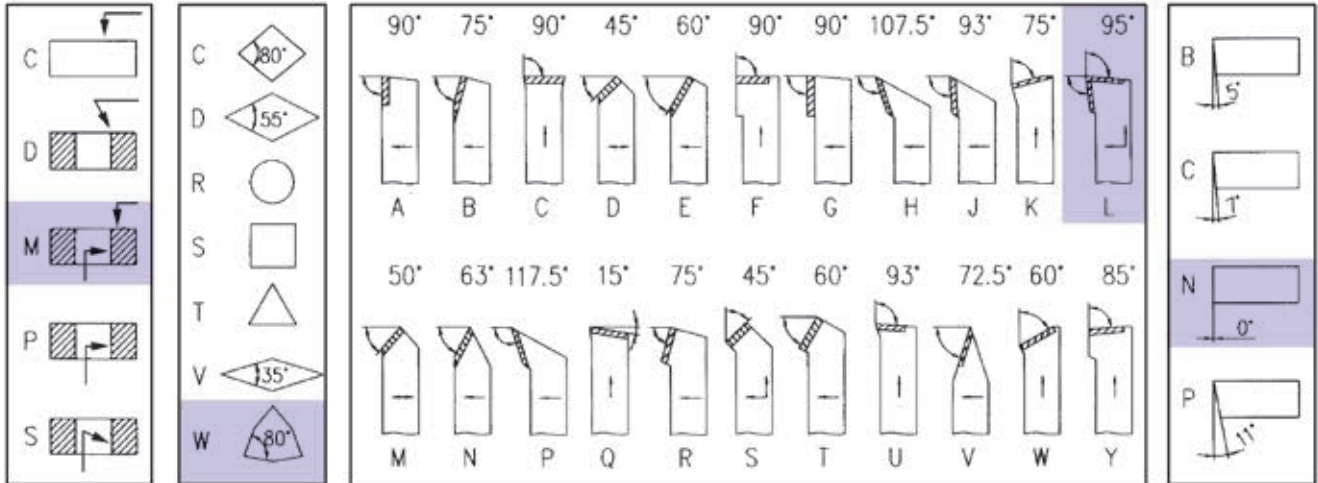

⑤ R

Vorhubrichtung
Feeding direction
Sens de l'avance
Senso di avanzamento
Dirección de corte
进给方向

⑥ 25

Schafthöhe
Shank height
Hauter des porte-plaquettes
Altezza portainserito
Altura del mango
刀柄高度

⑦ 25

Schaftbreite
Shank width
Largeur des porte-plaquettes
Larghezza portainserito
Longitud del mango
刀柄宽度

⑧ M

Werkzeuglänge
Total length
Longueur totale
Lunghezza totale
Longitud total
总长度

⑨ 08



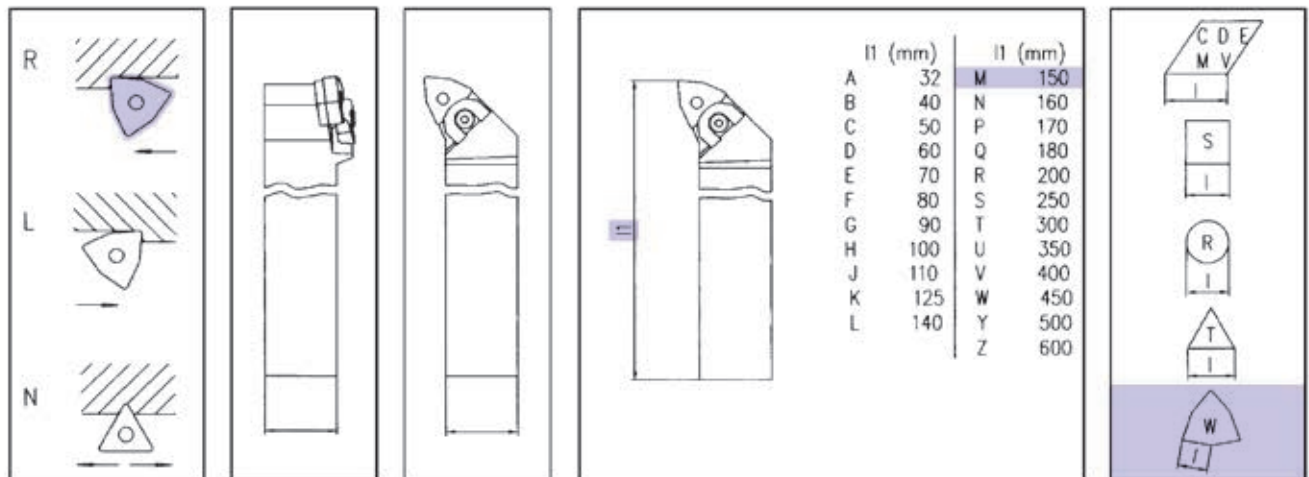

Schneidkantenlänge
Insert cutting edge length
Longueur des arêtes des plaquettes
Lunghezza del profilo inserto
Medida de la arista de las plaquetas
插件的切削边缘长度

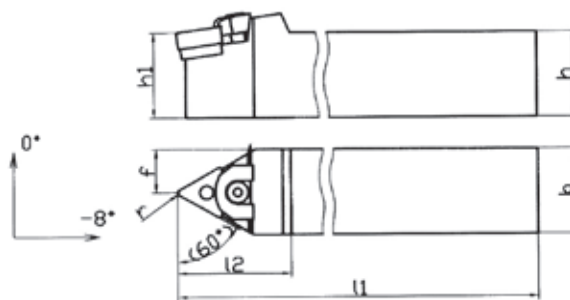

MTEN





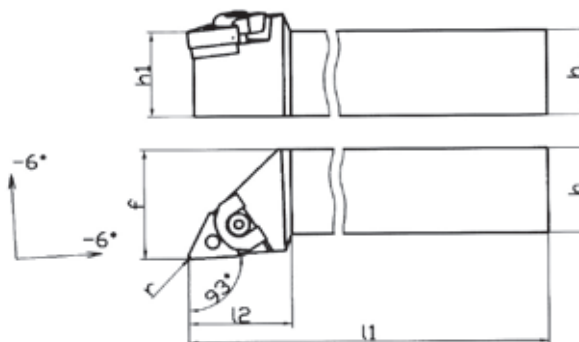

CODE N.	h	b	l1	l2	h1	f	r	INSERTS N.
MTENN 2525M22	25	25	150	35	25	12.5	0.8	TN..2204..

SUPPORT PAD	CLAMP	PIN	SCREW
 MSPTN22	 STF04	 PER03	 VT16

MTJN









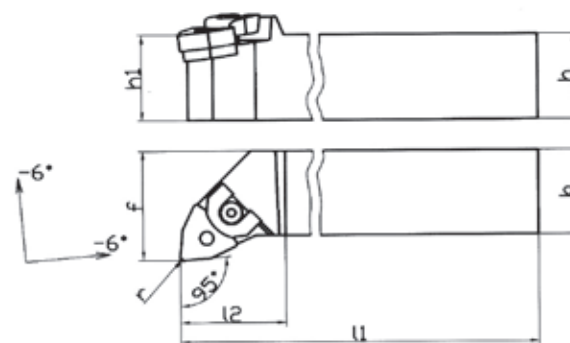





CODE N.	h	b	l1	l2	h1	f	r	INSERTS N.
MTJNR/L 2525M16	25	25	150	30	25	32	0.8	TN..1604..

SUPPORT PAD	CLAMP	PIN	SCREW
 MSPTN16	 STF01	 PER02	 VT14

MWLN





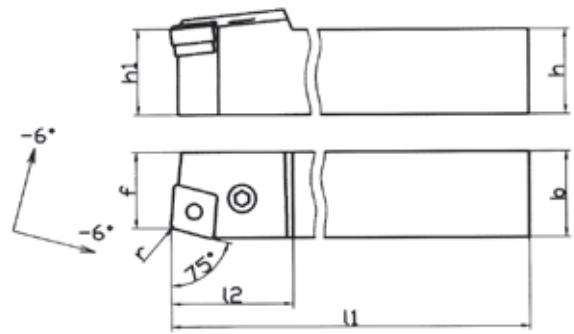

CODE N.	h	b	l1	l2	h1	f	r	INSERTS N.
MWLN/R/L 2525M08	25	25	150	31	25	32	0.8	WN..0804..
MWLN/R/L 3225P08	32	25	170	31	32	32	0.8	WN..0804..
MWLN/R/L 3232P08	32	32	170	31	32	40	0.8	WN..0804..

SUPPORT PAD	CLAMP	PIN	SCREW
 MSPWN08	 STF10	 PER03	 VT16
 MSPWN08	 STF10	 PER03	 VT16
 MSPWN08	 STF10	 PER03	 VT16

PCBN





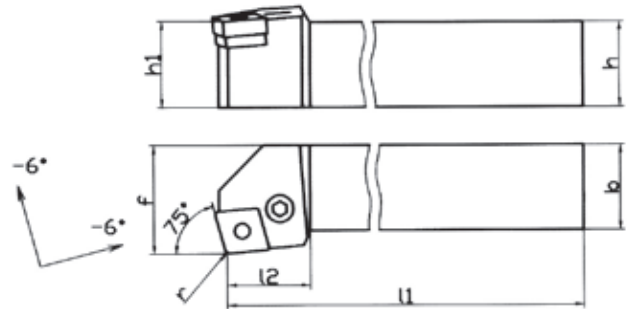

CODE N.	h	b	l1	l2	h1	f	r	INSERTS N.
PCBNR/L 2525M12	25	25	150	37	25	22	0.8	CNM.1204..
PCBNR/L 2525M16	25	25	150	37	25	22	1.2	CNM.1606..

SUPPORT PAD	SHIM PIN	LEVER	SCREW
			
SPCN12	SP02	LV02	VT02
SPCN16	SP03	LV03	VT03

PCKN





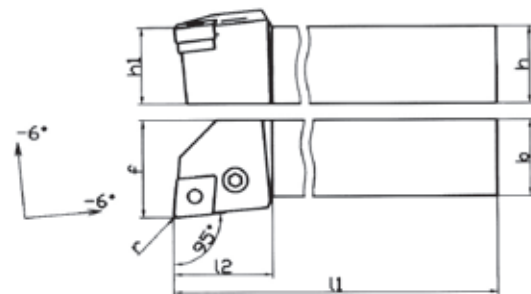

CODE N.	h	b	l1	l2	h1	f	r	INSERTS N.
PCKNR/L 2020K12	20	20	125	24	20	25	0.8	CNM.1204..
PCKNR/L 2525M12	25	25	150	26	25	32	0.8	CNM.1204..

SUPPORT PAD	SHIM PIN	LEVER	SCREW
			
SPCN12	SP02	LV02	VT02
SPCN12	SP02	LV02	VT02

PCLN





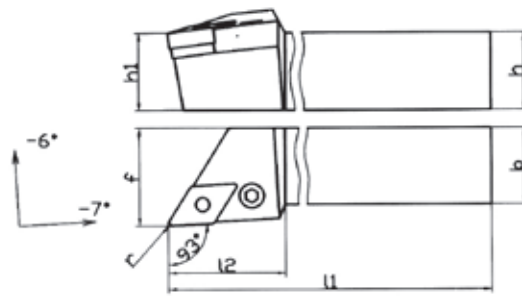

CODE N.	h	b	l1	l2	h1	f	r	INSERTS N.
PCLNR/L 1616H12	16	16	100	26	16	20	0.8	CNM.1204..
PCLNR/L 2020K12	20	20	125	28	20	25	0.8	CNM.1204..
PCLNR/L 2525M12	25	25	150	33	25	32	0.8	CNM.1204..
PCLNR/L 4040S16	40	40	250	39	40	50	1.2	CNM.1606..
PCLNR/L 2525M19	25	25	150	39	25	32	1.2	CNM.1906..
PCLNR/L 3232P19	32	32	170	39	32	40	1.2	CNM.1906..
PCLNR/L 4040S19	40	40	250	39	40	50	1.2	CNM.1906..

SUPPORT PAD	SHIM PIN	LEVER	SCREW
			
SPCN12	SP02	LV02	VT11
SPCN12	SP02	LV02	VT02
SPCN12	SP02	LV02	VT02
SPCN16	SP03	LV03	VT03
SPCN19	SP09	LV04	VT04
SPCN19	SP09	LV04	VT04
SPCN19	SP09	LV04	VT04

PDJN





CODE N.	h	b	l1	l2	h1	f	r	INSERTS N.
PDJNR/L 2020K15	20	20	125	35	20	25	0.8	DNM.1506..
PDJNR/L 2525M15	25	25	150	39	25	32	0.8	DNM.1506..
PDJNR/L 3232P15	32	32	170	39	32	40	0.8	DNM.1506..
PDJNR/L 4025R15	40	25	200	39	40	32	0.8	DNM.1506..

SUPPORT PAD	SHIM PIN	LEVER	SCREW
			
SPDN15	SP02	LV05	VT05
SPDN15	SP02	LV05	VT05
SPDN15	SP02	LV05	VT05
SPDN15	SP02	LV05	VT05

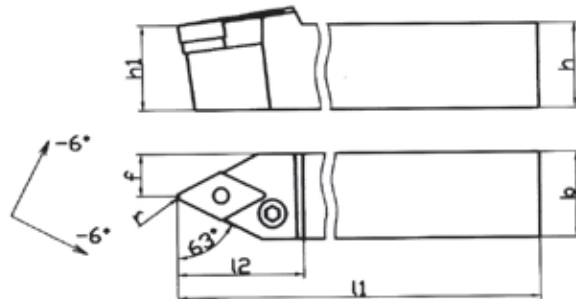
PDNN





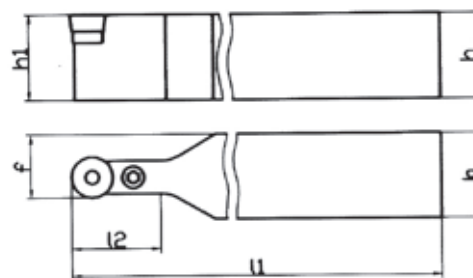

CODE N.	h	b	l1	l2	h1	f	r	INSERTS N.
PDNNR/L 2525M15	25	25	150	37	25	12.5	0.8	DNM.1506..

SUPPORT PAD	SHIM PIN	LEVER	SCREW
			
SPDN15	SP02	LV05	VT05

PRDC



CODE N.	h	b	l1	l2	h1	f	INSERTS N.
PRDCN 2525M10	25	25	150	21	25	17.5	RCM.100300.
PRDCN 2525M12	25	25	150	26	25	18.5	RCM.120400.

SUPPORT PAD	SHIM PIN	LEVER	SCREW
			
SPRC10	SP01	LV07	VT07
SPRC12	SP01	LV08	VT01

PSSN

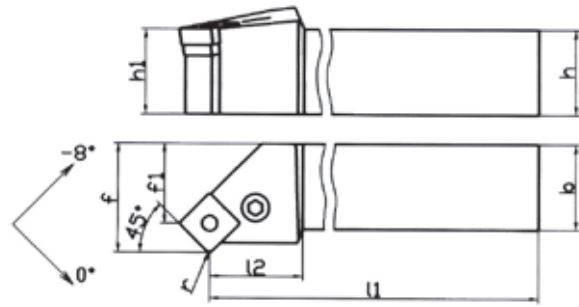

CODE N.	h	b	l1	l2	h1	f	f1	r	INSERTS N.	SUPPORT PAD	SHIM PIN	LEVER	SCREW
PSSNR/L 2020K12	20	20	125	22	20	25	17	0.8	SNM.1204..				
PSSNR/L 2525M12	25	25	150	25	25	32	24	0.8	SNM.1204..	SPSN12	SP02	LV02	VT02
PSSNR/L 3232P19	32	32	170	29	32	40	26	1.2	SNM.1906..				
PSSNR/L 4040S19	40	40	250	29	40	50	40	1.2	SNM.1906..	SPSN19	SP09	LV04	VT04

PWLN

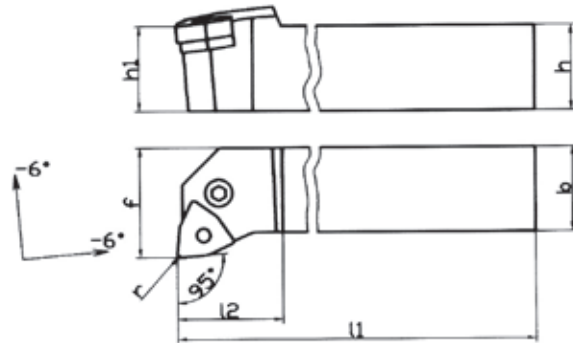

CODE N.	h	b	l1	l2	h1	f	r	INSERTS N.	SUPPORT PAD	SHIM PIN	LEVER	SCREW
PWLN/L 2020K08	20	20	125	28	20	25	0.8	WN..0804..				
PWLN/L 2525M08	25	25	150	33	25	32	0.8	WN..0804..	SPWN08	SP02	LV02	VT02

SCLC

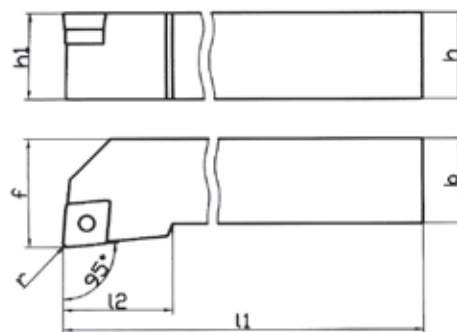

CODE N.	h	b	l1	l2	h1	f	r	INSERTS N.	SUPPORT PAD	BUSH	SCREW
SCLCR/L 2020K09	20	20	125	29	20	25	0.8	CC..09T3..			
SCLCR/L 2020K12	20	20	125	29	20	25	0.8	CC..1204..	SPCC12	VTA01	TR4

SDJC

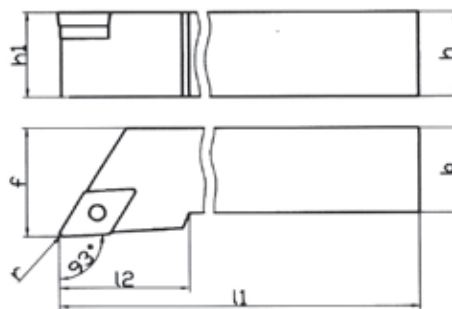

CODE N.	h	b	l1	l2	h1	f	r	INSERTS N.	SUPPORT PAD	BUSH	SCREW
SDJCR/L 1212F11	12	12	80	29	12	16	0.8	DC..11T3..		-	TR14
SDJCR/L 1616H11	16	16	100	29	16	20	0.8	DC..11T3..	SPDC11	VTA02	TR8
SDJCR/L 2020K11	20	20	125	29	20	25	0.8	DC..11T3..	SPDC11	VTA02	TR8
SDJCR/L 2525M11	25	25	150	33	25	32	0.8	DC..11T3..	SPDC11	VTA02	TR8

SDNC

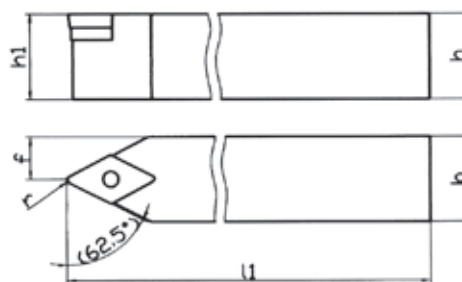

CODE N.	h	b	l1	h1	f	r	INSERTS N.	SUPPORT PAD	BUSH	SCREW
SDNCN 2020K11	20	20	125	20	10	0.8	DC..11T3..			
SDNCN 2525M11	25	25	150	25	12.5	0.8	DC..11T3..	SPDC11	VTA02	TR8

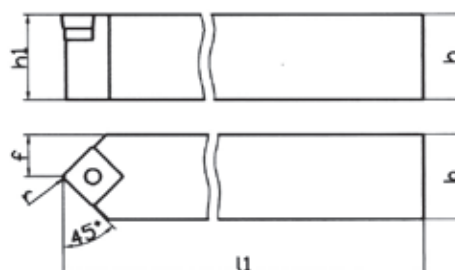

SSDC



CODE N.	h	b	l1	h1	f	r	INSERTS N.	SUPPORT PAD	BUSH	SCREW
SSDCN 1616H09	16	16	100	16	8	0.8	SCM.09T3..			
SSDCN 2020K12	20	20	125	20	10	0.8	SCM.1204..	SPSC12	VTA01	TR4

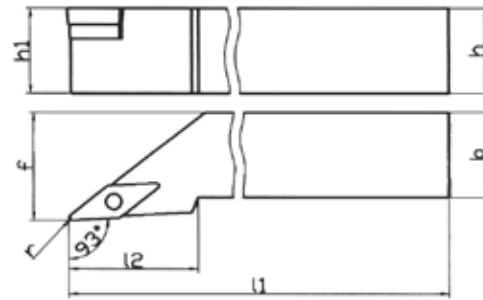

SVJB



CODE N.	h	b	l1	l2	h1	f	r	INSERTS N.	SUPPORT PAD	BUSH	SCREW
SVJBR/L 1616H11	16	16	100	29	16	20	0.4	VB..1102..			
SVJBR/L 2020K11	20	20	125	29	20	25	0.4	VB..1102..	-	-	TR1
SVJBR/L 2525M11	25	25	150	29	25	32	0.4	VB..1102..	-	-	TR1
SVJBR/L 2020K16	20	20	125	35	20	25	0.8	VB..1604..	SPVC16	VTA02	TR8
SVJBR/L 2525M16	25	25	150	35	25	32	0.8	VB..1604..	SPVC16	VTA02	TR8

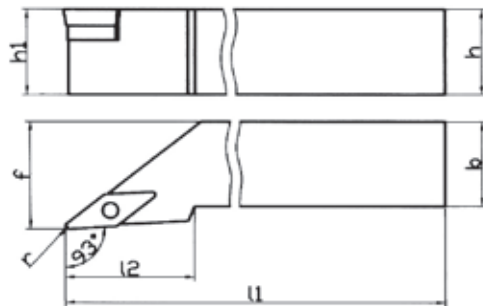

SVJC



CODE N.	h	b	l1	l2	h1	f	r	INSERTS N.	SUPPORT PAD	BUSH	SCREW
SVJCR/L 1616H11	16	16	100	23	16	20	0.4	VC..1103..			
SVJCR/L 2020K11	20	20	125	23	20	25	0.4	VC..1103..	-	-	TR1
SVJCR/L 2020K16	20	20	125	34	20	25	0.8	VC..1604..	SPVC16	VTA02	TR8

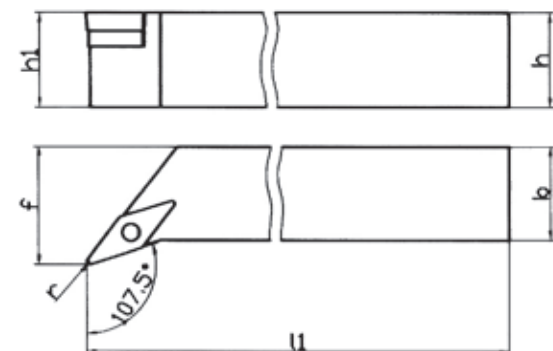

SVHB

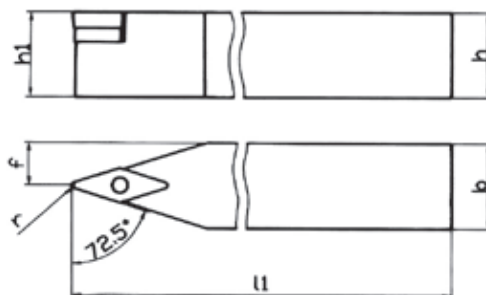

CODE N.	h	b	l1	h1	f	r	INSERTS N.	SUPPORT PAD	BUSH	SCREW
SVHBR/L 2525M16	25	25	150	25	32	0.8	VB..1604..			

SVVB



CODE N.	h	b	l1	h1	f	r	INSERTS N.	SUPPORT PAD	BUSH	SCREW
SWBN 2525M16	25	25	150	25	12.5	0.8	VB..1604..	 SPVC16	 VTA02	 TR8

15

KINTEK®

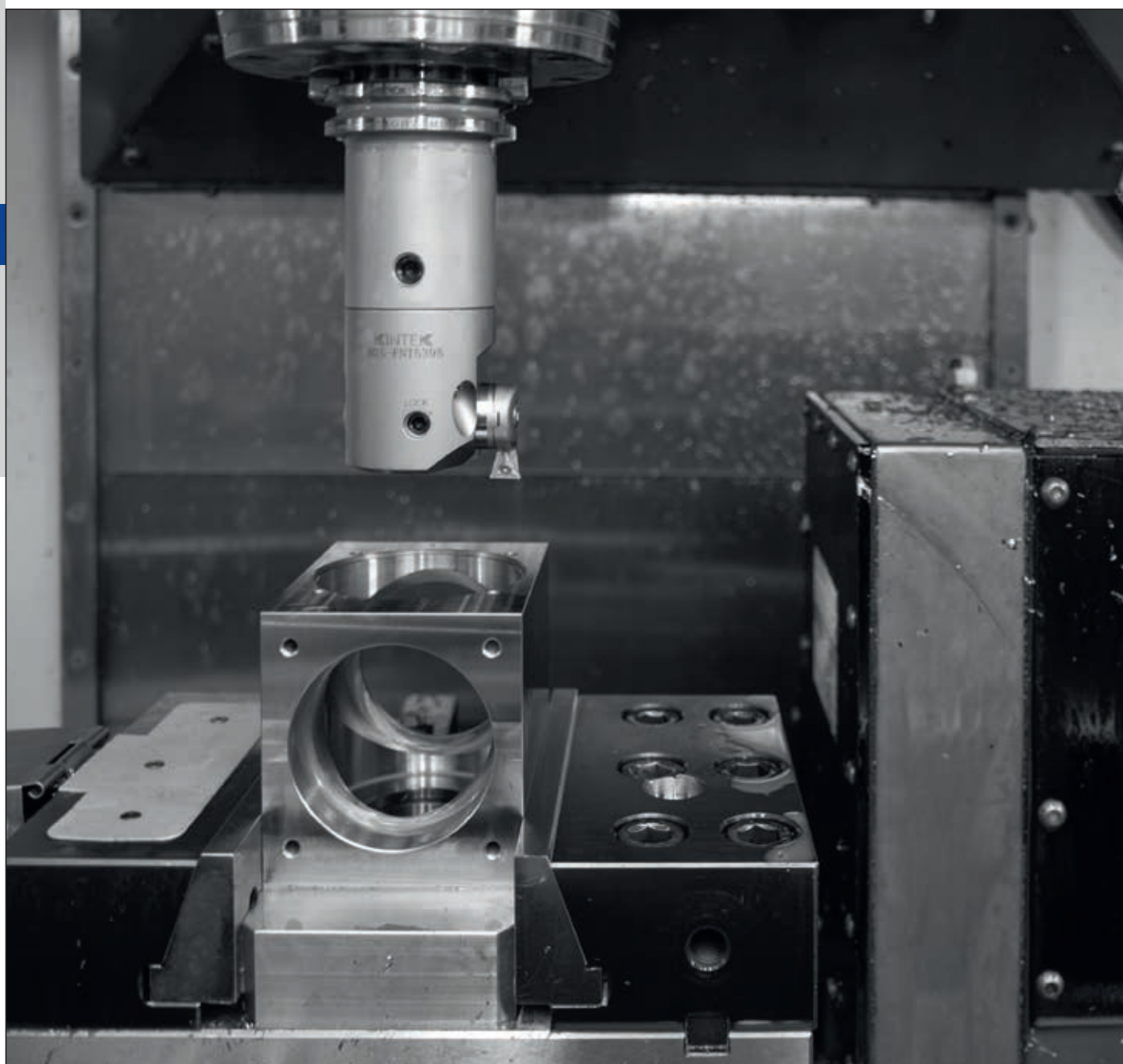

IDENTIFICATION OF THE INTERNAL (I.D.) BORING TOOLS

BEZEICHNUNG VON KLEMMHALTERN FÜR INNENBEARBEITUNG
IDENTIFICACION DE LAS BARRAS DE MANDRINAR
СИСТЕМА ОБОЗНАЧЕНИЯ РАСТОЧНЫХ ДЕРЖАВОК

IDENTIFICAZIONE DEI BARENI PER INTERNI
DESIGNATION DES BARRES D'ALEPAGE INTERIEURES
镗刀的内部标识

① S

Konstruktion
Construction
Costruzione
Fabricación
结构

A	Toll holder with oil hole Stell shank
C	Carbide shank
E	Toll holder with oil hole Carbide shank
S	Stell shank

② 25

Klemmhalterdurchmesser
Turning tools diameter
Diametre des porte-plaquettes
Diámetro dei porta inserti
Diámetro de los porta-plaquitas
车刀直径

08	ø8
10	ø10
12	ø12
16	ø16
20	ø20
25	ø25
32	ø32
40	ø40
50	ø50

③ T

Werkzeuglänge
Total length
Longueur totale
Lunghezza totale
Longitud total
总长

l1 (mm)	
F	80
H	100
K	125
M	150
P	170
Q	180
R	200
X	225
S	250
T	300
U	350
V	400
W	450
Z	600

④ P

Spannsystem
Clamping system
Système de serrage
Sistema di bloccaggio
Sistema de fijación
夹紧系统

C	
M	
P	
S	

S	25	T	P	D	U	N	R	11
①	②	③	④	⑤	⑥	⑦	⑧	⑨

⑤ D

Plattform
Insert Shape
Forme des plaquettes
Forma degli inserti
Forma de las plaquitas
插件形状

C	
D	
S	
T	
V	
W	

⑥ U

Austellwinkel
Shape of turning tools
Forme des porte-plaquettes
Forma dei portainseriti
Forma de los porta-plaquitas
车刀的形状

90°		F
75°		K
95°		L
117.5°		P
107.5°		Q
93°		U

⑦ N

Freiwinkel
Clearance angle
Angle de depouil
Angolo di spoglia
Angulo de incidencia
间隙角度

B	
C	
N	
P	

⑧ R

Vorshubrichtung
Freeding direction
Sens de l'avance
Senso di avanzamento
Dirección de corte
进给方向

R	
L	
N	

⑨ 11

Schneidkantenlänge
Insert cutting edge length
Longueur des arêtes des plaquettes
Lunghezza del profilo inserto
Medida de la arista de las plaquitas
插件的切削边缘长度

C D	
V	
S	
I	
T	
L	
W	

MWLN

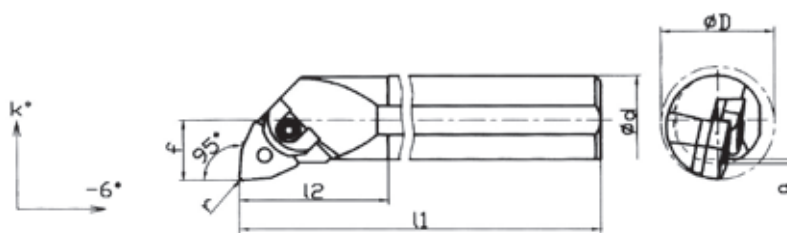

CODE N.	d	l1	l2	f	a	K°	D	r	INSERTS N.	SUPPORT PAD	CLAMP	PIN
S25SMWLN/L08	25	250	42	17	2	-12	32	0.8	WN..0804..	-	STF10	PER08
S32UMWLN/L08	32	350	49	22	2	-12	40	0.8	WN..0804..	MSPWN08	STF10	PER08
S40VMWLN/L08	40	400	56	27	2	-10	50	0.8	WN..0804..	MSPWN08	STF10	PER08
S50VMWLN/L08	50	450	63	35	2	-10	63	0.8	WN..0804..	MSPWN08	STF10	PER08

PCLN

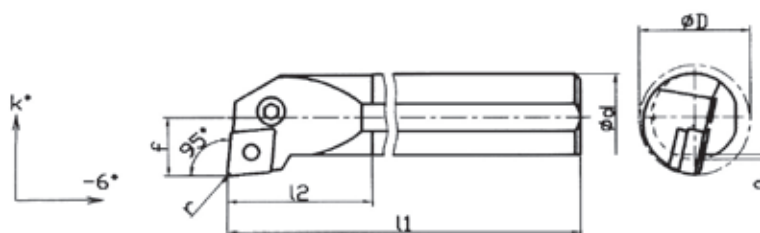

CODE N.	d	l1	l2	f	a	K°	D	r	INSERTS N.	SUPPORT PAD	SHIM PIN	LEVER	SCREW
S25TPCLNR/L12	25	300	45	17	2	-12	32	0.8	CNM..1204..	SPCN12	SP02	LV02	VT10
S32UPCLNR/L12	32	350	50	22	2	-10	40	0.8	CNM..1204..	SPCN12	SP02	LV02	VT02
S40VPCLNR/L12	40	400	60	27	2	-10	50	0.8	CNM..1204..	SPCN12	SP02	LV02	VT02
S40VPCLNR/L16	40	400	60	27	2	-10	50	1.2	CNM..1606..	SPCN16	SP03	LV03	VT03
S50WPCLNR/L16	50	450	75	35	2	-8	63	1.2	CNM..1606..	SPCN16	SP03	LV03	VT03
S50WPCLNR/L19	50	450	75	35	2	-8	63	1.2	CNM..1906..	SPCN19	SP04	LV04	VT04

PDUN

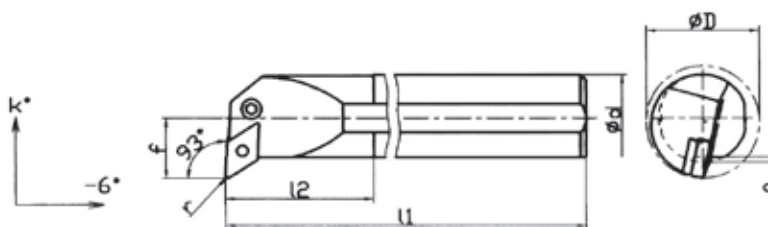

CODE N.	d	l1	l2	f	a	K°	D	r	INSERTS N.	SUPPORT PAD	SHIM PIN	LEVER	SCREW
S32UPDUNR/L15	32	350	60	22	2	-15	40	0.8	DN..1506..	SPDN15	SP02	LV05	VT05
S40VPDUNR/L15	40	400	60	27	2	-12	50	0.8	DN..1506..	SPDN15	SP02	LV05	VT05
S50WPDUNR/L15	50	450	70	35	2	-8	63	0.8	DN..1506..	SPDN15	SP02	LV05	VT05

SCLC

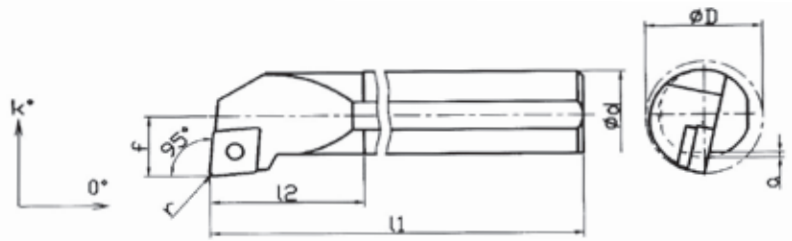

CODE N.	d	l1	l2	f	a	K°	D	r	INSERTS N.	SUPPORT PAD	BUSH	SCREW
S08HSCLCR/L06	8	100	25	6	0.5	-12	11	0.4	CC..0602..			
S10KSCLCR/L06	10	125	25	7	0.5	-10	13	0.4	CC..0602..	-	-	TR1
S12MSCLCR/L06	12	150	30	9	0.5	-10	16	0.4	CC..0602..	-	-	TR1
S16RSCLCR/L06	16	200	40	11	1	-10	20	0.4	CC..0602..	-	-	TR1
S16RSCLCR/L09	16	200	40	11	1	-10	20	0.8	CC..09T3..	-	-	TR12
S20SSCLCR/L09	20	250	40	13	1.5	-8	25	0.8	CC..09T3..	-	-	TR14
S25TSCLCR/L12	25	300	50	17	2	-5	32	0.8	CC..1204..	-	-	TR13
S32USCLCR/L12	32	350	60	22	2	-5	40	0.8	CC..1204..	SPCC12	VTA01	TR4
S40VSCLCR/L12	40	400	60	27	2	-5	50	0.8	CC..1204..	SPCC12	VTA01	TR4

SDUC

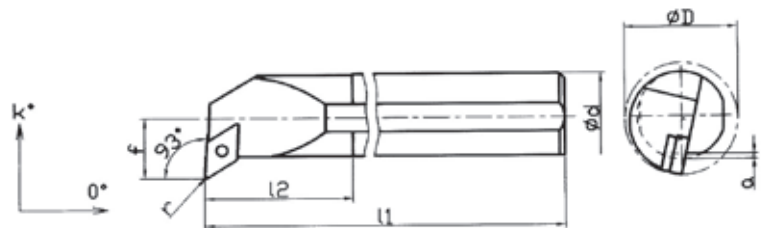

CODE N.	d	l1	l2	f	a	K°	D	r	INSERTS N.	SUPPORT PAD	BUSH	SCREW
S10KSDUCR/L07	10	125	25	7	0.5	-10	13	0.4	DC..0702..			
S12MSDUCR/L07	12	150	25	9	0.5	-10	16	0.4	DC..0702..	-	-	TR1
S16RSDUCR/L07	16	200	40	11	1	-10	20	0.4	DC..0702..	-	-	TR1
S20SSDUCR/L11	20	250	40	13	1.5	-8	25	0.8	DC..11T3..	-	-	TR12
S25TSDUCR/L11	25	300	45	17	2	-5	32	0.8	DC..11T3..	-	-	TR14
S32USDUCR/L11	32	350	60	22	2	-5	40	0.8	DC..11T3..	SPDC11	VTA02	TR8

STFC

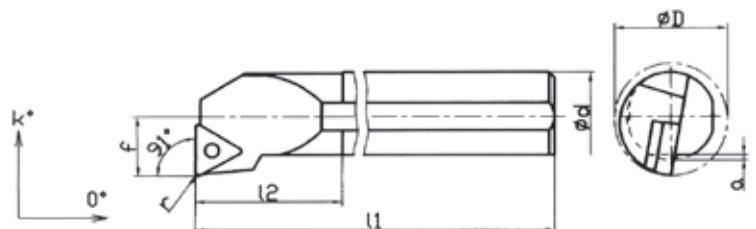

CODE N.	d	l1	l2	f	a	K°	D	r	INSERTS N.	SUPPORT PAD	BUSH	SCREW
S10KSTFCR/L11	10	125	28	7	0.5	-12	13	0.4	TC..1102..			
S16RSTFCR/L11	16	200	40	11	1	-8	20	0.4	TC..1102..	-	-	TR1
S20SSTFCR/L16	20	250	45	13	1.5	-8	25	0.8	TC..16T3..	-	-	TR14
S25TSTFCR/L16	25	300	50	17	2	-5	32	0.8	TC..16T3..	-	-	TR14
S32USTFCR/L16	32	350	50	22	2	-5	40	0.8	TC..16T3..	SPTC16	VTA02	TR8