

 MITSUBISHI MATERIALS

INDEXABLE MILLING TOOLS



DIA  **EDGE**

NEW

MITSUBISHI MATERIALS

INTRODUCING THE NEW GENERAL CATALOGUE C009 – 2022/2023

TARGETED, COMPACT, HANDY.

Mitsubishi Materials' wide product portfolio is now shown in catalogues that represent individual application areas, offering users fast and easy access to targeted product information.

There is now a set of catalogues in small, practical sizes that comprise the following five volumes:

- **TURNING TOOLS**
- **DRILLING TOOLS**
- **SOLID MILLING TOOLS**
- **INDEXABLE MILLING TOOLS**
- **MPLUS**



NEW DESIGN

EASY HANDLING

HIGHER FLEXIBILITY

INDIVIDUAL APPLICATION AREAS

The slipcase provided enables easy storage and offers the required space for all future catalogues, including the product news brochures that will be published within the 2-year life cycle of the catalogue. Each new product news brochure published within the 2-year cycle will completely replace the previous version. Therefore, please dispose of old versions when new ones are supplied to ensure that the collection is up to date.

NOTES:

- With this publication, all previous general catalogues and product news brochures lose their validity.
- The product news catalogues are released twice a year, in April and October.
- The new general catalogue can be ordered only as a set of five. **Order number: C009E**



DIGITAL VERSION

For the digital version of the catalogue, please scan the QR code or visit us at www.mhg-mediastore.net

INDEXABLE MILLING TOOLS

EFFICIENCY - PASSION FOR PERFECTION

Exceeding customer expectations; that is the motto of Mitsubishi Materials.

Mitsubishi Materials focuses on the ever-growing customer requirements and develops economically sustainable tooling solutions to meet the high demands of the market.

From efficient roughing cutters through to micron-precise indexable insert milling tools, Mitsubishi Materials is committed to the manufacture and supply of milling tools of the highest quality.

DIA EDGE

CREATE A BETTER FUTURE TOGETHER WITH OUR CUSTOMERS

Announcing DIAEDGE, our new brand of tools that brings together cutting-edge technologies, exciting all who use them.

The aim is not only to offer value with our tools, but to think together with customers, share inspiration and continue to take on new challenges.



MITSUBISHI MATERIALS

INDEX

INDEXABLE MILLING TOOLS

ROTATING TOOLS	K001
ROTATING TOOL INSERTS	L001
SPARE PARTS	N001
TECHNICAL DATA	P001
INDEX	1
GENERAL INFORMATION	



INDEXABLE MILLING TOOLS

ROTATING TOOLS

SYMBOL DESCRIPTIONS K002
 CLASSIFICATION..... K004

STANDARD OF MILLING

FACE MILLING

WSX445..... K016
 ASX445..... K026
 AHX440S..... K034
 AHX475S..... K038
 AHX640S..... K041
 AHX640W..... K048

FACE MILLING (HIGH FEED)

NEW FMAX..... K051

SHOULDER MILLING

NEW WWX400..... K056
 VOX400..... K065
 ASX400..... K068

MULTI FUNCTIONAL MILLING

NEW WJX..... K072
 VPX200..... K086
 VPX300..... K100
 APX3000..... K133
 APX4000..... K140
 AXD4000..... K155
NEW AXD4000A..... K162
 AXD7000..... K166
 AQX..... K172
 AJX..... K180
 ARP..... K238
 BRP..... K190

DEEP SHOULDER MILLING

NEW VPX200 LONG CUTTING EDGE TYPE ... K114
NEW VPX300 LONG CUTTING EDGE TYPE ... K124
 APX3000 LONG CUTTING EDGE TYPE ... K147
 APX4000 LONG CUTTING EDGE TYPE ... K151
 VFX5..... K192
 VFX6..... K196
 DCCC..... K200
 SPX..... K203
NEW ASPX..... K208

BALL NOSE END MILLING

SRF,SRB..... K212
 SRM2..... K220
 SRM2 ϕ 40, ϕ 50..... K228

RADIUS END MILLING

SUF..... K216

CHAMFER MILLING

CESP,CFSP,CGSP..... K230

T-SLOT MILLING

TSMP..... K232

VERTICAL FEED MILLING

PMF..... K234
 PMR..... K236

ARBORS

ARBORS FOR SCREW-IN TOOLS ... K244

MAXIMUM ALLOWABLE
 REVOLUTIONS FOR CUTTERS ... K246

LIST OF CUTTING

EDGE DIAMETER TOLERANCES ... K247



*Alphabetical Order Index

K034	AXH440S	K155	AXD4000	K232	TSMP
K038	AXH475S	K162	AXD4000A	K192	VFX5
K041	AXH640S	K166	AXD7000	K196	VFX6
K048	AXH640W	K190	BRP	K065	VOX400
K180	AJX	K230	CESP/CFSP/CGSP	K086	VPX200
K133	APX3000	K200	DCCC	K114	VPX300
K147	APX3000 LONG CUTTING EDGE TYPE	K051	FMAX	K100	VPX300
K140	APX4000	K234	PMF	K124	VPX300 LONG CUTTING EDGE TYPE
K151	APX4000 LONG CUTTING EDGE TYPE	K236	PMR	K072	WJX09
K172	AQX	K203	SPX	K079	WJX14
K238	ARP	K212	SRF/SRB	K016	WSX445
K208	ASPX	K216	SUF	K056	WWX400
K068	ASX400	K220	SRM2	K244	ARBORS FOR SCREW-IN TOOLS
K026	ASX445	K228	SRM2 ϕ 40, ϕ 50		

SYMBOL DESCRIPTIONS

KAPR (Cutting Edge Angle) List

15°
KAPR

30°
KAPR

45°
KAPR

50°
KAPR

60°
KAPR

90°
KAPR

R
KAPR

Application

 Face Milling

 Chamfer Milling

 Shoulder Milling with R

 Face Milling Close to a Wall

 Shoulder Milling

 Side Milling

 Slot Milling

 Step Milling

 Pocket Milling

 Slot Milling with Corner R

 Copy Milling

 T-Slot Milling

 Helical Drilling

● : Inventory maintained.

★ : Inventory maintained in Japan.

□ : Non stock, produced to order only.

Machining Precision

-  **Finish Cutting**

-  **Medium Cutting**

-  **Rough Cutting**

























Work Material Range



























- 1st Recommendation**
- P M K N S H**
- 2nd Recommendation**
- P M K N S H**
-

CLASSIFICATION (ARBOR type)

ROTATING TOOLS

K

Product Name · Shape	APMX (mm)	Features	Cutter Dia. (mm)	Work Material	Page
For General Cutting WSX445  	5	<ul style="list-style-type: none"> ● Unique design double sided insert. ● Sudden fracture & welding prevention function. ● Highly efficient chip discharge. 	Ø40 — Ø200		K016
For General Cutting ASX445  	6	<ul style="list-style-type: none"> ● Precision inexpensive moulded type 20° positive insert. ● Screw-on type. ● A wide range of chipbreakers. ● High rigidity due to carbide shim. 	Ø50 — Ø315		K026
For General Cutting AHX440S  	3	<ul style="list-style-type: none"> ● Heptagonal double sided insert. ● Economical 14 cutting edge inserts. ● Multi insert design for high feed machining. 	Ø40 — Ø160		K034
For High Feed Cutting AHX475S  	1.6	<ul style="list-style-type: none"> ● Heptagonal double sided insert. ● Economical 14 cutting edge inserts. ● Multi insert design for high feed machining. ● With through coolant holes. 	Ø50 — Ø160		K038
For General Cutting AHX640S  	6	<ul style="list-style-type: none"> ● Heptagonal double sided insert. ● Economical 14 cutting edge inserts. ● Multi insert design for high feed machining. 	Ø63 — Ø200		K041
For High Feed Cutting for Cast Iron AHX640W  	6	<ul style="list-style-type: none"> ● Heptagonal double sided insert. ● Economical 14 cutting edge inserts. ● Multi insert design for high feed machining. 	Ø80 — Ø315		K048
For High Feed Finishing FMAX  	2	<ul style="list-style-type: none"> ● Feed Maximum (FMAX) milling cutter for ultra efficient and accurate finishing. ● Light Weight, High Rigidity Body & Economy, Multi-use ● With through coolant holes. 	Ø40 — Ø125		K051
Multi Functional Milling NEW WJX09 	1.2	<ul style="list-style-type: none"> ● Negative inserts. ● Stable clamp with dovetail structure. ● Suitable for high feed machining. ● Special insert design with 6 cutting edges. ● With through coolant holes. 	Ø40 — Ø66		K072
Multi Functional Milling WJX14 	2.0	<ul style="list-style-type: none"> ● Negative inserts. ● Stable clamp with dovetail structure. ● Suitable for high feed machining. ● Special insert design with 6 cutting edges. ● With through coolant holes. 	Ø50 — Ø160		K079

Product Name · Shape	APMX (mm)	Features	Cutter Dia. (mm)	Work Material	Page
Multi Functional Cutting AJX 	1.2	<ul style="list-style-type: none"> ● 15° positive insert. ● High rigidity double clamp structure. ● Suitable for high feed cutting. ● Special insert design with 3 cutting edges. ● With through coolant holes. 	Ø50 — Ø160		K180
Multi Functional Milling of Difficult-to-cut Materials ARP  	5 6	<ul style="list-style-type: none"> ● Run-out does not occur easily when changing sections. ● Strong clamping system. ● Standardized stock of extra fine pitch. ● With through coolant holes. 	Ø40 — Ø100		K238
Multi Functional Cutting BRP  	6 8	<ul style="list-style-type: none"> ● 11° positive insert. ● Round shape insert with a strong cutting edge. ● Wide range of tools available. ● Suitable for mould machining. 	Ø40 — Ø100		K190
For General Cutting NEW WWX400  	8.2	<ul style="list-style-type: none"> ● High-stability clamping and high quality machining. ● The optimised "X-type" insert meets the demand for greater strength. ● Economical double sided 6 corners. 	Ø50 — Ø250		K056
For Cast Iron VOX400  	10	<ul style="list-style-type: none"> ● Tangential inserts with high strength cutting edge. ● Economical 8 cutting edge inserts. ● Screw-on type. 	Ø50 — Ø250		K065
For General Cutting ASX400  	10	<ul style="list-style-type: none"> ● High accuracy, high quality vertical wall. ● Low cutting force insert. ● With through air & coolant holes. 	Ø50 — Ø250		K068
Multi Functional Cutting for High Efficiency Machining VPX200  	8	<ul style="list-style-type: none"> ● Special insert design with 4 cutting edges. ● High precision, high quality insert cutting edge with finishing blade. ● With through coolant holes. 	Ø32 — Ø63		K089
Multi Functional Cutting for High Efficiency Machining VPX300  	11	<ul style="list-style-type: none"> ● Special insert design with 4 cutting edges. ● High precision, high quality insert cutting edge with finishing blade. ● With through coolant holes. 	Ø40 — Ø80		K103
For Multi Functional Cutting APX3000  	10	<ul style="list-style-type: none"> ● Low cutting force insert. ● High accuracy, high quality vertical wall. ● With through air & coolant holes. 	Ø32 — Ø100		K135













K

ROTATING TOOLS



























CLASSIFICATION (ARBOR type)

K

ROTATING TOOLS

Product Name · Shape	APMX (mm)	Features	Cutter Dia. (mm)	Work Material	Page
For Multi Functional Cutting APX4000  	15	<ul style="list-style-type: none"> ● Low cutting force insert. ● High accuracy, high quality vertical wall. ● With through air & coolant holes. 	Ø40 — Ø160		K142
Aluminium Alloy to Difficult-to-cut Material Cutting AXD4000  	14.8 15.5	<ul style="list-style-type: none"> ● Low resistance chipbreaker. ● Low resistance insert and high rigidity design for excellent performance. ● For high-speed machining. ● Multi-functional machining. ● With through coolant holes. 	Ø40 — Ø125		K155
Ultra-high Speed, Efficient Machining of Aluminium Alloys NEW AXD4000A  	14.8 15.5	<ul style="list-style-type: none"> ● Low resistance chipbreaker. ● Low resistance insert and high rigidity design for excellent performance. ● For continuous high-speed and ultra-high-speed machining. ● Multi-functional machining. 	Ø50		K162
Aluminium Alloy to Difficult-to-cut Material Cutting AXD7000  	20.4 21	<ul style="list-style-type: none"> ● Low resistance chipbreaker. ● Low resistance insert and high rigidity design for excellent performance. ● For high-speed machining. ● Multi-functional machining. ● With through coolant holes. 	Ø50 — Ø125		K166

CLASSIFICATION (SHANK type)



















Product Name · Shape	APMX (mm)	Features	Cutter Dia. (mm)	Work Material	Page
WSX445  	5	<ul style="list-style-type: none"> ● Unique design double sided insert. ● Sudden fracture & welding prevention function. ● Highly efficient chip discharge. ● With through coolant holes. 	Ø40 — Ø63		K018
ASX445  	6	<ul style="list-style-type: none"> ● Precision inexpensive moulded type 20° positive insert. ● Screw-on type. ● A wide range of chipbreakers. ● High rigidity due to carbide shim. 	Ø50 Ø63		K027
WWX400  	8.2	<ul style="list-style-type: none"> ● High-stability clamping and high quality machining. ● The optimised "X-type" insert meets the demand for greater strength. ● Economical double sided 6 corners. 	Ø50 — Ø80		K058
ASX400  	10	<ul style="list-style-type: none"> ● High tolerance M-class inserts. ● Economical 4 cutting edge inserts. ● Curved cutting edge and high rigidity holder. ● Screw-on type. 	Ø40 — Ø63		K069
VPX200  	8	<ul style="list-style-type: none"> ● Special insert design with 4 cutting edges. ● High precision, high quality insert cutting edge with finishing blade. ● With through coolant holes. 	Ø16 — Ø50		K086
VPX300  	11	<ul style="list-style-type: none"> ● Special insert design with 4 cutting edges. ● High precision, high quality insert cutting edge with finishing blade. ● With through coolant holes. 	Ø25 — Ø50		K100
APX3000  	10	<ul style="list-style-type: none"> ● High accuracy, high quality vertical wall. ● Low cutting force insert. ● With through air & coolant holes. 	Ø12 — Ø63		K133
APX4000  	15	<ul style="list-style-type: none"> ● High accuracy, high quality vertical wall. ● Low cutting force insert. ● With through air & coolant holes. 	Ø25 — Ø63		K140
AXD4000  	14.8 15.5	<ul style="list-style-type: none"> ● Low resistance chipbreaker. ● Low resistance insert and high rigidity design for excellent performance. ● For high-speed machining. ● Multi-functional machining. ● With through coolant holes. 	Ø20 — Ø40		K156



























K

ROTATING TOOLS

CLASSIFICATION (SHANK type)

ROTATING TOOLS

Product Name · Shape	APMX (mm)	Features	Cutter Dia. (mm)	Work Material	Page
AXD7000  	20.4 21	<ul style="list-style-type: none"> ● Low resistance chipbreaker. ● Low resistance insert and high rigidity design for excellent performance. ● For high-speed machining. ● Multi-functional machining. ● With through coolant holes. 	Ø32 — Ø50	N	K166
AQX  	7.4 55	<ul style="list-style-type: none"> ● The centre bottom cutting edge enables drilling without previously formed hole. ● With through coolant holes. 	Ø16 — Ø50	P M K N S H	K172
AJX 	0.6 1.2	<ul style="list-style-type: none"> ● 13° and 15° positive inserts. ● High rigidity double clamp structure. ● Suitable for high feed cutting. ● Special insert design with 3 cutting edges. ● With through coolant holes. 	Ø16 — Ø63	P M K S H	K183
WJX09  	1.2	<ul style="list-style-type: none"> ● Multi functional milling. ● Negative inserts. ● Stable clamp with dovetail structure. ● Suitable for high feed machining. ● Special insert design with 6 cutting edges. ● With through coolant holes. 	Ø25 — Ø40	P M K S H	K073
WJX14 	2.0	<ul style="list-style-type: none"> ● Multi functional milling. ● Negative inserts. ● Stable clamp with dovetail structure. ● Suitable for high feed machining. ● Special insert design with 6 cutting edges. ● With through coolant holes. 	Ø50	P M K S H	K080
ARP  	5 6	<ul style="list-style-type: none"> ● Accurate insert run out. ● Solid clamping system. ● Standard stock item of extra fine pitch. ● With through coolant holes. 	Ø25 — Ø50	M S	K239
VPX200 Long Cutting Edge   	14 42	<ul style="list-style-type: none"> ● Special insert design with 4 cutting edges. ● High precision, high quality insert cutting edge. ● With through coolant holes. 	Ø20 — Ø40	P M K N S	K115
VPX200 Shell Type   	35 42	<ul style="list-style-type: none"> ● Special insert design with 4 cutting edges. ● High precision, high quality insert cutting edge. ● With through coolant holes. 	Ø32 — Ø50	P M K N S	K116
VPX300 Long Cutting Edge   	21 42	<ul style="list-style-type: none"> ● Special insert design with 4 cutting edges. ● High precision, high quality insert cutting edge. ● With through coolant holes. 	Ø40	P M K N S	K124

Product Name · Shape	APMX (mm)	Features	Cutter Dia. (mm)	Work Material	Page
VPX300 Shell Type  	31 63	<ul style="list-style-type: none"> ● Special insert design with 4 cutting edges. ● High precision, high quality insert cutting edge. ● With through coolant holes. 	Ø40 — Ø80		K125
APX3000 Long Cutting Edge  	28 55	<ul style="list-style-type: none"> ● High accuracy, high quality vertical wall machining. ● Low cutting force insert. 	Ø20 — Ø40		K147
APX3000 Shell Type  	37 46	<ul style="list-style-type: none"> ● High accuracy, high quality vertical wall machining. ● Low cutting force insert. ● With through coolant holes. 	Ø40 Ø50		K148
APX4000 Long Cutting Edge  	56 84	<ul style="list-style-type: none"> ● High accuracy, high quality vertical wall machining. ● Low cutting force insert. ● With through air & coolant holes. 	Ø40 Ø50		K151
APX4000 Shell Type  	42 56	<ul style="list-style-type: none"> ● High accuracy, high quality vertical wall machining. ● Low cutting force insert. ● With through coolant holes. 	Ø50 Ø63		K152
DCCC  	27 83	<ul style="list-style-type: none"> ● Different helical flute angles prevents chattering. 	Ø25 — Ø40		K200
SPX  	110 261	<ul style="list-style-type: none"> ● Low cutting resistance due to the use of wavy inserts. ● Suitable for heavy cutting due to holder rigidity. 	Ø63		K203
SPX Shell Type  	58	<ul style="list-style-type: none"> ● Low cutting resistance due to the use of wavy inserts. ● Suitable for heavy cutting due to holder rigidity. 	Ø63 Ø80		K204
ASPX Shell Type  	54 75	<ul style="list-style-type: none"> ● High performance titanium alloy milling. ● Low cutting resistance due to the use of wavy inserts. ● Suitable for heavy cutting due to holder rigidity. 	Ø50 — Ø80		K208





















K



ROTATING TOOLS

CLASSIFICATION (SHANK type)

ROTATING TOOLS

K

Product Name · Shape	APMX (mm)	Features	Cutter Dia. (mm)	Work Material	Page
ASPX  	127	<ul style="list-style-type: none"> ● High performance titanium alloy milling. ● Low cutting resistance due to the use of wavy inserts. ● Suitable for heavy cutting due to holder rigidity. 	Ø80	S	K209
VFX5  	26 75	<ul style="list-style-type: none"> ● High performance titanium alloy milling. ● High rigidity design. ● Highly reliable clamping mechanism. ● With through coolant holes. 	Ø40 — Ø80	S	K192
VFX6  	31 90	<ul style="list-style-type: none"> ● High performance titanium alloy milling. ● High rigidity design. ● Highly reliable clamping mechanism. ● With through coolant holes. 	Ø63 — Ø100	S	K196
SRF/SRB  	5 17	<ul style="list-style-type: none"> ● S-shaped cutting edge provides sharpness similar to that of solid ball nose end mills. ● Highly accurate corner radius tolerance allows for high precision finishing. ● Carbide shank type available. 	Ø10 — Ø32	P K N H	K212
SUF  	1.5 5.2	<ul style="list-style-type: none"> ● Highly accurate corner radius tolerance allows for high precision finishing. ● Seamless gash. 	Ø10 — Ø32	P M K H	K216
SRM2  	12 44	<ul style="list-style-type: none"> ● Suitable for roughing to semi-finishing of small and medium moulds. ● High rigidity body design. ● Low resistance chipbreaker. ● Through coolant hole. 	Ø16 — Ø32	P M K S H	K220
SRM2 Ø40/Ø50  	54 63	<ul style="list-style-type: none"> ● Best for roughing of moulds. ● Low resistance chipbreaker. ● Highly rigid body. 	Ø40 Ø50	P K	K228
CESP·CFSP·CGSP    	5.9 10.2	<ul style="list-style-type: none"> ● Covers 5 cutting modes. ● Excellent sharpness with 11° positive inserts. ● 30°, 45° and 60° chamfer series. 	Ø8 — Ø32	P K	K230
TSMP  	11 18	<ul style="list-style-type: none"> ● T-groove order number 14, 18 and 22 are available. ● 86° rhombic shape 11° positive insert. ● Shoulder milling and inversed spot facing are also possible. 	Ø25 — Ø40	P K	K232



























Product Name · Shape	APMX (mm)	Features	Cutter Dia. (mm)	Work Material	Page
PMF 	0.1	<ul style="list-style-type: none"> ● 2 directional cutting with large overhang. ● Excellent straightness. ● Excellent wall accuracy. 	Ø50 — Ø80	P K	K234
PMR 	11	<ul style="list-style-type: none"> ● 2 directional cutting with large overhang. ● Horizontal feed cutting and oblique cutting are also possible. ● Unique shape of curved edge gives high rigidity and low resistance. 	Ø50 — Ø63	P K	K236













K

ROTATING TOOLS

CLASSIFICATION (SCREW-IN type)

ROTATING TOOLS











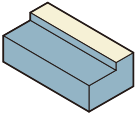

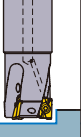
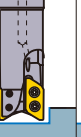
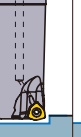



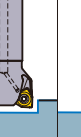

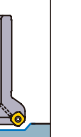
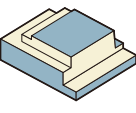
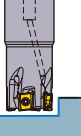
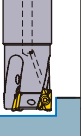



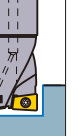

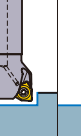

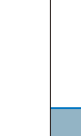
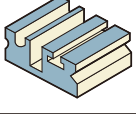



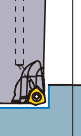

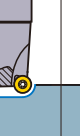
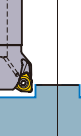

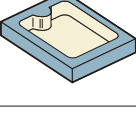



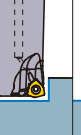

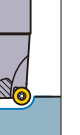

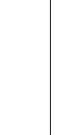
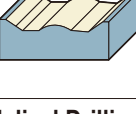



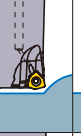

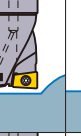



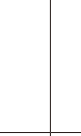
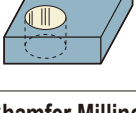

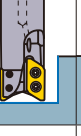
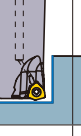
Product Name · Shape	APMX (mm)	Features	Cutter Dia. (mm)	Work Material	Page
ASX400  	10	<ul style="list-style-type: none"> ● High tolerance M-class inserts. ● Economical 4 cutting edge inserts. ● Curved cutting edge and high rigidity holder. ● Screw-on type. ● With through coolant holes. 	$\varnothing 32$ $\varnothing 40$		K069
APX3000  	10	<ul style="list-style-type: none"> ● High accuracy, high quality vertical wall machining. ● Low cutting force insert. ● With through air & coolant holes. 	$\varnothing 16 - \varnothing 40$		K136
APX4000  	15	<ul style="list-style-type: none"> ● High accuracy, high quality vertical wall machining. ● Low cutting force insert. ● With through air & coolant holes. 	$\varnothing 25 - \varnothing 40$		K143
AQX  	7.4 18	<ul style="list-style-type: none"> ● The centre bottom cutting edge enables drilling without previously formed hole. ● With through coolant holes. 	$\varnothing 16 - \varnothing 40$		K174
VPX200  	8	<ul style="list-style-type: none"> ● Special insert design with 4 cutting edges. ● High precision, high quality insert cutting edge with finishing blade. ● With through coolant holes. 	$\varnothing 16 - \varnothing 40$		K088
VPX300  	11	<ul style="list-style-type: none"> ● Special insert design with 4 cutting edges. ● High precision, high quality insert cutting edge. ● With through coolant holes. 	$\varnothing 25 - \varnothing 40$		K102
AJX 	0.6 1.2	<ul style="list-style-type: none"> ● 13° and 15° positive inserts. ● High rigidity double clamp structure. ● Suitable for high feed cutting. ● Special insert design with 3 cutting edges. ● With through coolant holes. 	$\varnothing 16 - \varnothing 40$		K182
WJX09  	1.2	<ul style="list-style-type: none"> ● Multi functional milling. ● Negative inserts. ● Stable clamp with dovetail structure. ● Suitable for high feed machining. ● Special insert design with 6 cutting edges. ● With through coolant holes. 	$\varnothing 25 - \varnothing 40$		K073
ARP  	5 6	<ul style="list-style-type: none"> ● Run-out does not occur easily when changing sections. ● Solid clamping system. ● With through coolant holes. 	$\varnothing 25 - \varnothing 40$		K240





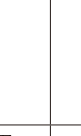

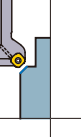

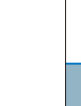

Product Name · Shape	APMX (mm)	Features	Cutter Dia. (mm)	Work Material	Page
BRP  	4 6	<ul style="list-style-type: none"> ● 11° positive insert. ● Round shape insert with a strong cutting edge. ● Wide range of tools available. ● Suitable for mould machining. 	Ø16 — Ø42		K190
SRF/SRB  	8 17	<ul style="list-style-type: none"> ● S-shaped cutting edge provides sharpness similar to that of solid ball nose end mills. ● Highly accurate corner radius tolerance allows for high precision finishing. ● Carbide shank type available. ● With through coolant holes. 	Ø16 — Ø32		K213
SUF  	2.1 5.2	<ul style="list-style-type: none"> ● Highly accurate corner radius tolerance allows for high precision finishing. ● Seamless gash. ● With through coolant holes. 	Ø16 — Ø32		K217
SRM2  	12 44	<ul style="list-style-type: none"> ● Suitable for roughing to semi-finishing of small and medium moulds. ● High rigidity body design. ● Low resistance chipbreaker. ● With through coolant holes. 	Ø16 — Ø32		K222

CLASSIFICATION

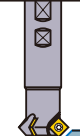
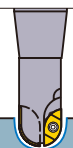
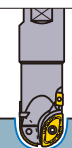
K

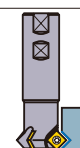
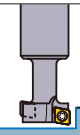
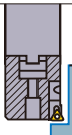
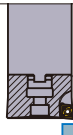
ROTATING TOOLS

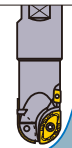
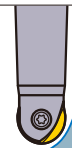
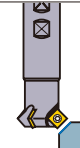
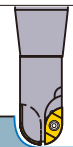
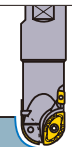
	Multi Functional Type							General Type			Long Cutting Edge Type
Product Name	VPX200 VPX300	APX3000 APX4000	AXD4000 AXD7000	NEW WJX09 WJX14	AJX	AQX	ARP	NEW WWX400	ASX400	ASX445 WSX445	NEW VPX200 VPX300 Long Cutting Edge Type
Cutting Mode	↻ K086 ↻ K100	↻ K133 ↻ K140	↻ K156 ↻ K166	↻ K073 ↻ K080	↻ K183	↻ K172	↻ K239	↻ K058	↻ K069	↻ K027 ↻ K018	↻ K114 ↻ K124
Face Milling 											
Shoulder Milling 											
Slot Milling 											
Pocket Milling 											
Copy Milling 											
Helical Drilling 											
Chamfer Milling 											
Radius Milling 											

	Long Cutting Edge Type					Ball Nose / Radius Type				Special Purpose Type			
	APX3000 APX4000 Long Cutting Edge Type  ↻ K147 ↻ K151	DCCC  ↻ K200	VFX5 VFX6  ↻ K192 ↻ K196	NEW ASPX  ↻ K208	SPX  ↻ K203	SRM2  ↻ K220	SRM2 $\phi 40/\phi 50$  ↻ K228	SRF/SRB For Finishing  ↻ K212	SUF For Finishing  ↻ K216	CESP CFSP CGSP  ↻ K230	TSMP  ↻ K232	PMF  ↻ K234	PMR  ↻ K236
									 *1	 *1			
	 *1	 *1	 *1	 *1	 *1	 *1	 *1	 *1	 *1	 *1	 *2	 *3	 *3
						 *1	 *1	 *1	 *1				
										 *1			
						 *1	 *1	 *1					

*1 V-Slot Milling *2 T-Slot Milling *3 Plunging

ROTATING TOOLS

FACE MILLING <GENERAL CUTTING>



WSX445



K

ROTATING TOOLS

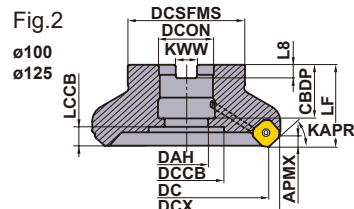
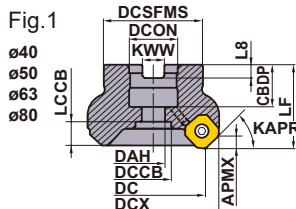

Right hand tool holder shown.

ARBOR TYPE RIGHT HAND TOOL HOLDER

KAPR : 45°

GAMP : +17°

GAMF : -6° - +1°

DC (mm)	Order Number	Stock	Coolant Hole	Number of Teeth	Type	Dimensions (mm)			WT [*] (kg)	APMX (mm)	Fig.
						DCX	LF	DCON			
40	WSX445-040A03AR	●	○	3	Coarse Pitch	52.8	40	16	0.3	5	1
40	WSX445-040A04AR	●	○	4	Fine Pitch	52.8	40	16	0.3	5	1
50	WSX445-050A03AR	●	○	3	Coarse Pitch	62.9	40	22	0.5	5	1
50	WSX445-050A04AR	●	○	4	Fine Pitch	62.9	40	22	0.4	5	1
50	WSX445-050A05AR	●	○	5	Extra Fine Pitch	62.9	40	22	0.4	5	1
63	WSX445-063A04AR	●	○	4	Coarse Pitch	75.9	40	22	0.6	5	1
63	WSX445-063A05AR	●	○	5	Fine Pitch	75.9	40	22	0.6	5	1
63	WSX445-063A06AR	●	○	6	Extra Fine Pitch	75.9	40	22	0.6	5	1
80	WSX445-080A04AR	●	○	4	Coarse Pitch	92.9	50	27	1.3	5	1
80	WSX445-080A06AR	●	○	6	Fine Pitch	92.9	50	27	1.2	5	1
80	WSX445-080A08AR	●	○	8	Extra Fine Pitch	92.9	50	27	1.1	5	1
100	WSX445-100B05AR	●	○	5	Coarse Pitch	112.9	50	32	1.9	5	2
100	WSX445-100B07AR	●	○	7	Fine Pitch	112.9	50	32	1.9	5	2
100	WSX445-100B10AR	●	○	10	Extra Fine Pitch	112.9	50	32	1.8	5	2
125	WSX445-125B06AR	●	○	6	Coarse Pitch	137.9	63	40	3.4	5	2
125	WSX445-125B08AR	●	○	8	Fine Pitch	137.9	63	40	3.4	5	2
125	WSX445-125B12AR	●	○	12	Extra Fine Pitch	137.9	63	40	3.2	5	2
160	WSX445-160C07NR	●	—	7	Coarse Pitch	172.9	63	40	4.9	5	3
160	WSX445-160C10NR	●	—	10	Fine Pitch	172.9	63	40	4.8	5	3
160	WSX445-160C16NR	●	—	16	Extra Fine Pitch	172.8	63	40	4.6	5	3
200	WSX445-200C08NR	●	—	8	Coarse Pitch	212.9	63	60	7.5	5	4
200	WSX445-200C12NR	●	—	12	Fine Pitch	212.9	63	60	7.4	5	4
200	WSX445-200C20NR	●	—	20	Extra Fine Pitch	212.8	63	60	7.2	5	4

Note 1) A set bolt to the arbor is not supplied with the body.

Note 2) Please use a set bolt of the FMC (metric) type on the cutter body from 40 to 100 in diameter (DC).

Note 3) Please use a set bolt of the FMB type on the cutter body from 125 to 200 in diameter (DC).

* WT : Tool Weight

SPARE PARTS

Arbor Type	*	
	 Clamp Screw	 Wrench (Insert)
WSX445	TPS4R	TIP15W

* Clamp Torque (N · m) : TPS4R=3.5

● : Inventory maintained. ★ : Inventory maintained in Japan.

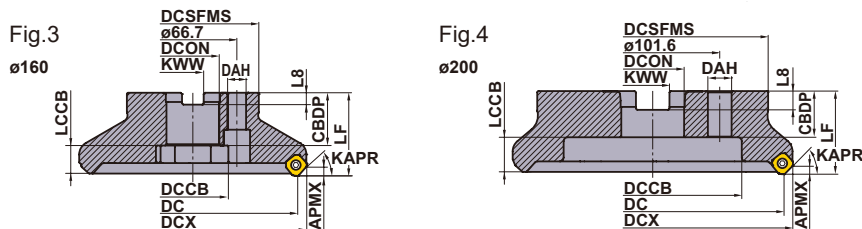

Right hand tool holder shown.

ARBOR TYPE LEFT HAND TOOL HOLDER

DC (mm)	Order Number	Stock	Coolant Hole	Number of Teeth	Type	Dimensions (mm)			WT [*] (kg)	APMX (mm)	Fig.
						DCX	LF	DCON			
80	WSX445-080A04AL	★	○	4	Coarse Pitch	92.9	50	27	1.3	5	1
100	WSX445-100B05AL	★	○	5	Coarse Pitch	112.9	50	32	1.9	5	2
125	WSX445-125B06AL	★	○	6	Coarse Pitch	137.9	63	40	3.4	5	2
160	WSX445-160C07NL	★	—	7	Coarse Pitch	172.9	63	40	4.9	5	3

Note 1) A set bolt to the arbor is not supplied with the body.

Note 2) Please use a set bolt of the FMC (metric) type on the cutter body from 80 to 100 in diameter (DC).

Note 3) Please use a set bolt of the FMB type on the cutter body from 125 to 160 in diameter (DC).

* WT : Tool Weight

SET BOLT (SOLD SEPARATELY)

Arbor Type	Set Bolt		Fig.	Reference Dimensions (mm)							Geometry
	With Coolant Hole	Without Coolant Hole		a	b	c	d	e	f	g	
	Order Number	Order Number									
WSX445-040A○○AR	HSC08025H	HSC08040	1	13	M8×1.25	33	8	5	—	—	Fig.1
WSX445-050A○○AR	HSC10030H	HSC10035	1	16	M10×1.5	40	10	6	—	—	
WSX445-063A○○AR	HSC10030H	HSC10035	1	16	M10×1.5	40	10	6	—	—	Fig.2
WSX445-080A○○A○	HSC12035H	HSC12035 (HSC12045)	1	18	M12×1.75	47 57	12	10	—	—	
WSX445-100B○○A○	MBA16033H	—	2	40	M16×2	43	10	14	6	23	
WSX445-125B○○A○	MBA20040H	—	2	50	M20×2.5	54	14	17	6	27	
WSX445-160C○○N○	No coolant hole	—	2	50	M20×2.5	54	14	17	6	27	
WSX445-200C○○NR	No coolant hole	—	1	24	M16×2	43	16	14	—	—	

Note 1) Internal coolant is necessary with the set bolt.

MOUNTING DIMENSION	> K020
SPARE PARTS	> N001
TECHNICAL DATA	> P001

ROTATING TOOLS

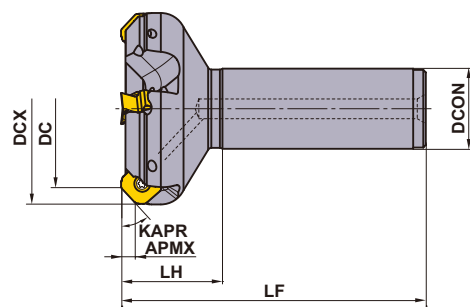
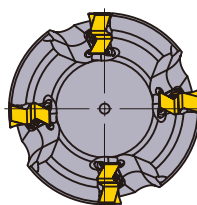

Right hand tool holder only.

K



ROTATING TOOLS

SHANK TYPE

DC (mm)	Order Number	Stock	Coolant Hole	Number of Teeth	Type	Dimensions (mm)				WT [*] (kg)	APMX (mm)
						DCX	LF	DCON	LH		
40	WSX445R4003SA32M	★	○	3	Coarse Pitch	52.8	125	32	40	0.8	5
40	WSX445R4004SA32M	★	○	4	Fine Pitch	52.8	125	32	40	0.8	5
50	WSX445R5003SA32M	★	○	3	Coarse Pitch	62.9	125	32	40	1.0	5
50	WSX445R5004SA32M	★	○	4	Fine Pitch	62.9	125	32	40	1.0	5
63	WSX445R6304SA32M	★	○	4	Coarse Pitch	75.9	125	32	40	1.2	5
63	WSX445R6305SA32M	★	○	5	Fine Pitch	75.9	125	32	40	1.2	5

* WT : Tool Weight

SPARE PARTS

Arbor Type		
	Clamp Screw	Wrench (Insert)
WSX445	TPS4R	TIP15W

* Clamp Torque (N • m) : TPS4R=3.5

● : Inventory maintained. ★ : Inventory maintained in Japan.
(10 inserts in one case)

INSERTS WITH BREAKER

Work Material	P	Steel											Cutting Conditions : ● : Stable Cutting ● : General Cutting ✦ : Unstable Cutting Honing : E : Round F : Sharp						
	M	Stainless Steel	●	●	●	●	●	●	●	●	●	●							
Shape	K	Cast Iron	●	●	●	●	●	●	●	●	●	●							
	N	Non-ferrous Metal	●	●	●	●	●	●	●	●	●	●							
	S	Heat-resistant Alloy, Titanium Alloy	●	●	●	●	●	●	●	●	●	●							
H	Hardened Steel	●	●	●	●	●	●	●	●	●	●								
Shape	Order Number	Class	Hand	Honing	Coated				Cermet	Carbide	Dimensions (mm)				Geometry				
					MC5020	MP6120	MP6130	MP7130	MP7140	MP9120	MP9130	VP15TF	VP20RT	MX3030		TF15	IC	S	BS
	SNGU140812ANFR-L	G	R	F										●	14	8.4	1.5	1.2	
	SNGU140812ANER-L	G	R	E	●	●	●	●	●	●	★	★	●		14	8.4	1.5	1.2	
	SNGU140812ANER-M	G	R	E	●	●	●	●	●	●	★	★	●		14	8.4	1.5	1.2	
	SNMU140812ANER-M	M	R	E	●	●	●	●	●	●	★	★	●		14	8.4	1.5	1.2	
	SNMU140812ANER-R	M	R	E	●	●	●				★	★			14	8.4	1.5	1.2	
	SNMU140812ANER-H	M	R	E	●	●	●				★	★			14	8.4	1.5	1.2	
	SNGU140812ANFL-L	G	L	F									★		14	8.4	1.5	1.2	
	SNGU140812ANEL-L	G	L	E	★	★	★				★	★			14	8.4	1.5	1.2	
	SNGU140812ANEL-M	G	L	E	★	★	★				★	★			14	8.4	1.5	1.2	
	SNMU140812ANEL-M	M	L	E	★	★	★				★	★			14	8.4	1.5	1.2	
SNMU140812ANEL-R	M	L	E	★	★	★				★				14	8.4	1.5	1.2		

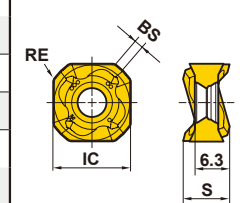

Right hand insert shown.

K
ROTATING TOOLS

WIPER INSERTS

Work Material	P	Steel											Cutting Conditions : ● : Stable Cutting ● : General Cutting ✦ : Unstable Cutting Honing : E : Round F : Sharp	
	M	Stainless Steel	●	●	●	●	●	●	●	●	●	●		
Shape	K	Cast Iron	●	●	●	●	●	●	●	●	●	●		
	S	Heat-resistant Alloy, Titanium Alloy	●	●	●	●	●	●	●	●	●	●		
	H	Hardened Steel	●	●	●	●	●	●	●	●	●	●		
Shape	Order Number	Class	Honing	Coated				Cermet	Dimensions (mm)					Geometry
				MC5020	MP6120	VP15TF	MX3020	L	W1	S	BS	RE		
	WNGU1406ANEN8C-M	G	E	●	●	●	●		16.87	16.87	6	8	1.0	

INSTRUCTIONS FOR USE OF WIPER INSERTS



Fig.1

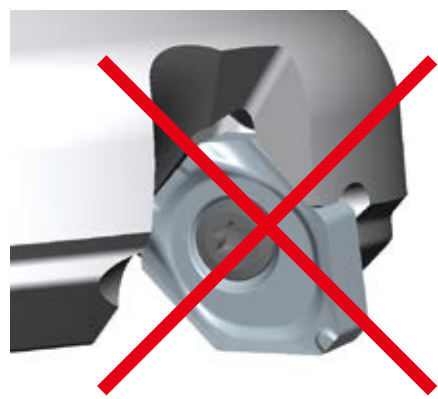

Fig.2

Wiper inserts for WSX445 are two-cornered. Please set as shown in Fig.1.

Excellent finished surfaces can be achieved with one wiper.

Set more than 2 wiper inserts, equally spaced, when the feed per revolution is larger than 8mm/rev.

SPARE PARTS > N001
TECHNICAL DATA > P001

ARBOR TYPE MOUNTING DIMENSIONS

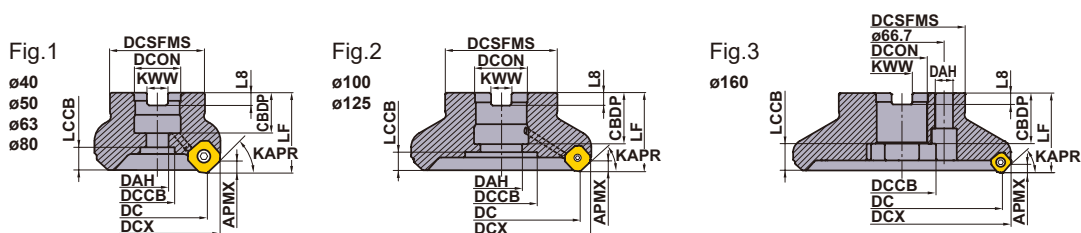

Right hand tool holder shown.

DC (mm)	Order Number	Dimensions (mm)								Fig.
		DCON	CBDP	DAH	DCCB	LCCB	DCSFMS	KWW	L8	
40	WSX445-040A03AR	16	18	9	14	13.3	37	8.4	5.6	1
40	WSX445-040A04AR	16	18	9	14	13.3	37	8.4	5.6	1
50	WSX445-050A03AR	22	20	11	17	11.3	47	10.4	6.3	1
50	WSX445-050A04AR	22	20	11	17	11.3	47	10.4	6.3	1
50	WSX445-050A05AR	22	20	11	17	11.3	47	10.4	6.3	1
63	WSX445-063A04AR	22	20	11	17	11.3	50	10.4	6.3	1
63	WSX445-063A05AR	22	20	11	17	11.3	50	10.4	6.3	1
63	WSX445-063A06AR	22	20	11	17	11.3	50	10.4	6.3	1
80	WSX445-080A04AR	27	23	13	20	14.3	56	12.4	7	1
80	WSX445-080A06AR	27	23	13	20	14.3	56	12.4	7	1
80	WSX445-080A08AR	27	23	13	20	14.3	56	12.4	7	1
80	WSX445-080A04AL	27	23	13	20	14.3	56	12.4	7	1
100	WSX445-100B05AR	32	26	26	45	16.3	78	14.4	8	2
100	WSX445-100B07AR	32	26	26	45	16.3	78	14.4	8	2
100	WSX445-100B10AR	32	26	26	45	16.3	78	14.4	8	2
100	WSX445-100B05AL	32	26	26	45	16.3	78	14.4	8	2
125	WSX445-125B06AR	40	28	30	56	21.3	89	16.4	9	2
125	WSX445-125B08AR	40	28	30	56	21.3	89	16.4	9	2
125	WSX445-125B12AR	40	28	30	56	21.3	89	16.4	9	2
125	WSX445-125B06AL	40	28	30	56	21.3	89	16.4	9	2

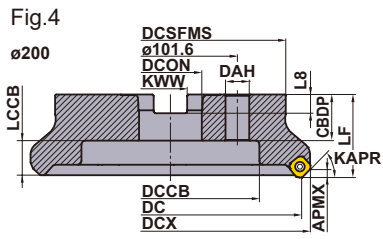

Right hand tool holder shown.

DC (mm)	Order Number	Dimensions (mm)								Fig.
		DCON	CBDP	DAH	DCCB	LCCB	DCSFMS	KWW	L8	
160	WSX445-160C07NR	40	40	14	56	21.3	100	16.4	9	3
160	WSX445-160C10NR	40	40	14	56	21.3	100	16.4	9	3
160	WSX445-160C16NR	40	40	14	56	21.3	100	16.4	9	3
160	WSX445-160C07NL	40	40	14	56	21.3	100	16.4	9	3
200	WSX445-200C08NR	60	32	18	135	29.3	160	25.7	14.22	4
200	WSX445-200C12NR	60	32	18	135	29.3	160	25.7	14.22	4
200	WSX445-200C20NR	60	32	18	135	29.3	160	25.7	14.22	4

ROTATING TOOLS

RECOMMENDED CUTTING CONDITIONS

■ Dry cutting

Work Material	Hardness	1st Recommendation	2nd Recommendation	Vc (m/min)	Finish Cutting		
					fz (mm/t.)	ap	
					L Breaker		
P					L Breaker		
Mild Steel	≤ 180HB	MP6120	VP15TF	250 (200–300)	0.15 (0.1–0.2)	≤ 1.0	
		MP6130	VP20RT	240 (190–290)	0.15 (0.1–0.2)	≤ 1.0	
		MX3030	–	180 (130–230)	0.15 (0.1–0.2)	≤ 1.0	
Carbon Steel Alloy Steel	180–350HB	MP6120	VP15TF	220 (170–270)	0.15 (0.1–0.2)	≤ 1.0	
		MP6130	VP20RT	200 (150–250)	0.15 (0.1–0.2)	≤ 1.0	
		MX3030	–	150 (120–180)	0.15 (0.1–0.2)	≤ 1.0	
Alloy Tool Steel	≤ 350HB (Annealing)	MP6120	VP15TF	220 (170–270)	0.15 (0.1–0.2)	≤ 1.0	
		MP6130	VP20RT	200 (150–250)	0.15 (0.1–0.2)	≤ 1.0	
		MX3030	–	150 (120–180)	0.15 (0.1–0.2)	≤ 1.0	
Pre-Hardened Steel	35–45HRC	MP6120	VP15TF	140 (100–180)	0.15 (0.1–0.2)	≤ 1.0	
		MP6130	VP20RT	120 (90–150)	0.15 (0.1–0.2)	≤ 1.0	
M					L Breaker		
Austenitic Stainless Steel	≤ 200HB	MP7130	VP15TF	200 (150–250)	0.15 (0.1–0.2)	≤ 1.0	
		MP7140	VP20RT	200 (150–250)	0.15 (0.1–0.2)	≤ 1.0	
		MX3030	–	130 (100–180)	0.15 (0.1–0.2)	≤ 1.0	
Austenitic Stainless Steel	>200HB	MP7130	VP15TF	170 (120–220)	0.15 (0.1–0.2)	≤ 1.0	
		MP7140	VP20RT	170 (120–220)	0.15 (0.1–0.2)	≤ 1.0	
Two-phase Stainless Steel	≤ 280HB	MP7130	VP15TF	160 (110–210)	0.15 (0.1–0.2)	≤ 1.0	
		MP7140	VP20RT	160 (110–210)	0.15 (0.1–0.2)	≤ 1.0	
Precipitation Hardening Stainless Steel	≤ 450HB	MP7130	VP15TF	150 (100–200)	0.15 (0.1–0.2)	≤ 1.0	
		MP7140	VP20RT	150 (100–200)	0.15 (0.1–0.2)	≤ 1.0	
K					L Breaker		
Gray Cast Iron	≤ 350MPa	MC5020	–	220 (200–270)	0.15 (0.1–0.2)	≤ 1.0	
		VP15TF	–	180 (130–250)	0.15 (0.1–0.2)	≤ 1.0	
		VP20RT	–	170 (120–240)	0.15 (0.1–0.2)	≤ 1.0	
		MX3030	–	150 (120–180)	0.15 (0.1–0.2)	≤ 1.0	
Ductile Cast Iron	≤ 450MPa	MC5020	–	200 (180–250)	0.15 (0.1–0.2)	≤ 1.0	
		VP15TF	VP20RT	160 (110–240)	0.15 (0.1–0.2)	≤ 1.0	
Ductile Cast Iron	≤ 800MPa	MC5020	–	200 (180–250)	0.15 (0.1–0.2)	≤ 1.0	
		VP15TF	–	160 (110–240)	0.15 (0.1–0.2)	≤ 1.0	
		VP20RT	–	150 (100–200)	0.15 (0.1–0.2)	≤ 1.0	
H					M Breaker		
Hardened Steel	40–55HRC	VP15TF	–	50 (30–70)	0.05 (0.05–0.1)	≤ 1.0	
Hardened Steel	55–62HRC	VP15TF	–	40 (20–50)	0.05 (0.05–0.1)	≤ 1.0	

Note 1) Refer to the table above and set the cutting conditions to match the application.

Note 2) Wet cutting is recommended when focusing on the surface finish. (Tool life is shorter when compared to dry cutting.)

(mm)

	Light Cutting		Medium Cutting		Rough Cutting		Heavy Cutting	
	fz (mm/t.)	ap	fz (mm/t.)	ap	fz (mm/t.)	ap	fz (mm/t.)	ap
	L,M Breaker		M Breaker		M,R Breaker		R,H Breaker	
	0.15 (0.1–0.2)	≤ 2.0	0.2 (0.15–0.25)	≤ 3.0	0.2 (0.15–0.25)	≤ 4.0	0.25 (0.2–0.3)	≤ 5.0
	0.15 (0.1–0.2)	≤ 2.0	0.2 (0.15–0.25)	≤ 3.0	0.2 (0.15–0.25)	≤ 4.0	0.25 (0.2–0.3)	≤ 5.0
	0.15 (0.1–0.2)	≤ 2.0	0.2 (0.15–0.25)	≤ 3.0	–	–	–	–
	0.15 (0.1–0.2)	≤ 2.0	0.2 (0.15–0.25)	≤ 3.0	0.2 (0.15–0.25)	≤ 4.0	0.25 (0.2–0.3)	≤ 5.0
	0.15 (0.1–0.2)	≤ 2.0	0.2 (0.15–0.25)	≤ 3.0	0.2 (0.15–0.25)	≤ 4.0	0.25 (0.2–0.3)	≤ 5.0
	0.15 (0.1–0.2)	≤ 2.0	0.2 (0.15–0.25)	≤ 3.0	–	–	–	–
	0.15 (0.1–0.2)	≤ 2.0	0.2 (0.15–0.25)	≤ 3.0	0.2 (0.15–0.25)	≤ 4.0	0.25 (0.2–0.3)	≤ 5.0
	0.15 (0.1–0.2)	≤ 2.0	0.2 (0.15–0.25)	≤ 3.0	0.2 (0.15–0.25)	≤ 4.0	0.25 (0.2–0.3)	≤ 5.0
	0.15 (0.1–0.2)	≤ 2.0	0.2 (0.15–0.25)	≤ 3.0	–	–	–	–
	0.15 (0.1–0.2)	≤ 2.0	0.2 (0.15–0.25)	≤ 3.0	0.2 (0.15–0.25)	≤ 4.0	0.25 (0.2–0.3)	≤ 5.0
	0.15 (0.1–0.2)	≤ 2.0	0.2 (0.15–0.25)	≤ 3.0	0.2 (0.15–0.25)	≤ 4.0	0.25 (0.2–0.3)	≤ 5.0
	L,M Breaker		M Breaker					
	0.15 (0.1–0.2)	≤ 2.0	0.2 (0.15–0.25)	≤ 3.0	–	–	–	–
	0.15 (0.1–0.2)	≤ 2.0	0.2 (0.15–0.25)	≤ 3.0	–	–	–	–
	0.15 (0.1–0.2)	≤ 2.0	–	–	–	–	–	–
	0.15 (0.1–0.2)	≤ 2.0	0.2 (0.15–0.25)	≤ 3.0	–	–	–	–
	0.15 (0.1–0.2)	≤ 2.0	0.2 (0.15–0.25)	≤ 3.0	–	–	–	–
	0.15 (0.1–0.2)	≤ 2.0	0.2 (0.15–0.25)	≤ 3.0	–	–	–	–
	0.15 (0.1–0.2)	≤ 2.0	0.2 (0.15–0.25)	≤ 3.0	–	–	–	–
	0.15 (0.1–0.2)	≤ 2.0	0.2 (0.15–0.25)	≤ 3.0	–	–	–	–
	L,M Breaker		M Breaker		M,R Breaker		R,H Breaker	
	0.15 (0.1–0.2)	≤ 2.0	0.2 (0.15–0.25)	≤ 3.0	0.2 (0.15–0.25)	≤ 4.0	0.25 (0.2–0.3)	≤ 5.0
	0.15 (0.1–0.2)	≤ 2.0	0.2 (0.15–0.25)	≤ 3.0	0.2 (0.15–0.25)	≤ 4.0	0.25 (0.2–0.3)	≤ 5.0
	0.15 (0.1–0.2)	≤ 2.0	0.2 (0.15–0.25)	≤ 3.0	0.2 (0.15–0.25)	≤ 4.0	0.25 (0.2–0.3)	≤ 5.0
	0.15 (0.1–0.2)	≤ 2.0	0.2 (0.15–0.25)	≤ 3.0	–	–	–	–
	0.15 (0.1–0.2)	≤ 2.0	0.2 (0.15–0.25)	≤ 3.0	0.2 (0.15–0.25)	≤ 4.0	0.25 (0.2–0.3)	≤ 5.0
	0.15 (0.1–0.2)	≤ 2.0	0.2 (0.15–0.25)	≤ 3.0	0.2 (0.15–0.25)	≤ 4.0	0.25 (0.2–0.3)	≤ 5.0
	0.15 (0.1–0.2)	≤ 2.0	0.2 (0.15–0.25)	≤ 3.0	0.2 (0.15–0.25)	≤ 4.0	0.25 (0.2–0.3)	≤ 5.0
	0.15 (0.1–0.2)	≤ 2.0	0.2 (0.15–0.25)	≤ 3.0	0.2 (0.15–0.25)	≤ 4.0	0.25 (0.2–0.3)	≤ 5.0
	0.15 (0.1–0.2)	≤ 2.0	0.2 (0.15–0.25)	≤ 3.0	0.2 (0.15–0.25)	≤ 4.0	0.25 (0.2–0.3)	≤ 5.0
	M,R Breaker		R,H Breaker					
	0.05 (0.05–0.1)	≤ 1.5	0.1 (0.05–0.15)	≤ 2.0	–	–	–	–
	0.05 (0.05–0.1)	≤ 1.5	0.1 (0.05–0.15)	≤ 2.0	–	–	–	–

K

ROTATING TOOLS

ROTATING TOOLS

RECOMMENDED CUTTING CONDITIONS

Wet Cutting

Work Material	Hardness	1st Recommendation	2nd Recommendation	Vc (m/min)	Finish Cutting		
					fz (mm/t.)	ap	
					L Breaker		
P					L Breaker		
Mild Steel	≤ 180HB	MP6120	VP15TF	150 (100–200)	0.15 (0.1–0.2)	≤ 1.0	
		MP6130	VP20RT	150 (100–200)	0.15 (0.1–0.2)	≤ 1.0	
Carbon Steel Alloy Steel	180–350HB	MP6120	VP15TF	120 (80–160)	0.15 (0.1–0.2)	≤ 1.0	
		MP6130	VP20RT	120 (80–160)	0.15 (0.1–0.2)	≤ 1.0	
Alloy Tool Steel	≤ 350HB (Annealing)	MP6120	VP15TF	120 (80–160)	0.15 (0.1–0.2)	≤ 1.0	
		MP6130	VP20RT	120 (80–160)	0.15 (0.1–0.2)	≤ 1.0	
Pre-Hardened Steel	35–45HRC	MP6120	VP15TF	100 (80–120)	0.15 (0.1–0.2)	≤ 1.0	
		MP6130	VP20RT	100 (80–120)	0.15 (0.1–0.2)	≤ 1.0	
M					L Breaker		
Austenitic Stainless Steel	≤ 200HB	MP7130	VP15TF	130 (80–180)	0.15 (0.1–0.2)	≤ 1.0	
		MP7140	VP20RT	130 (80–180)	0.15 (0.1–0.2)	≤ 1.0	
Austenitic Stainless Steel	> 200HB	MP7130	VP15TF	100 (80–150)	0.15 (0.1–0.2)	≤ 1.0	
		MP7140	VP20RT	100 (80–150)	0.15 (0.1–0.2)	≤ 1.0	
Two-phase Stainless Steel	≤ 280HB	MP7130	VP15TF	100 (80–150)	0.15 (0.1–0.2)	≤ 1.0	
		MP7140	VP20RT	100 (80–150)	0.15 (0.1–0.2)	≤ 1.0	
Precipitation Hardening Stainless Steel	≤ 450HB	MP7130	VP15TF	90 (50–140)	0.15 (0.1–0.2)	≤ 1.0	
		MP7140	VP20RT	90 (50–140)	0.15 (0.1–0.2)	≤ 1.0	
K					L Breaker		
Gray Cast Iron	≤ 350MPa	MC5020	–	180 (160–200)	0.15 (0.1–0.2)	≤ 1.0	
		VP15TF	VP20RT	130 (100–160)	0.15 (0.1–0.2)	≤ 1.0	
Ductile Cast Iron	≤ 450MPa	MC5020	–	180 (160–200)	0.15 (0.1–0.2)	≤ 1.0	
		VP15TF	VP20RT	130 (100–160)	0.15 (0.1–0.2)	≤ 1.0	
Ductile Cast Iron	≤ 800MPa	MC5020	–	180 (160–200)	0.15 (0.1–0.2)	≤ 1.0	
		VP15TF	VP20RT	110 (80–140)	0.15 (0.1–0.2)	≤ 1.0	
N					L Breaker		
Aluminium Alloy	–	TF15	–	≥ 300	0.15 (0.1–0.2)	≤ 1.0	
S					L Breaker		
Titanium Alloy	–	MP9120	VP15TF	50 (40–60)	0.05 (0.05–0.1)	≤ 1.0	
		MP9130	VP20RT	50 (40–60)	0.05 (0.05–0.1)	≤ 1.0	
Heat Resistant Alloy	–	MP9120	VP15TF	40 (20–50)	0.05 (0.05–0.1)	≤ 1.0	
		MP9130	VP20RT	40 (20–50)	0.05 (0.05–0.1)	≤ 1.0	

Note 1) Refer to the table above and set the cutting conditions to match the application.

Note 2) Wet cutting is recommended when focusing on the surface finish. (Tool life is shorter when compared to dry cutting.)

(mm)

Light Cutting		Medium Cutting		Rough Cutting		Heavy Cutting	
fz (mm/t.)	ap	fz (mm/t.)	ap	fz (mm/t.)	ap	fz (mm/t.)	ap
L,M Breaker		M Breaker		M,R Breaker		R,H Breaker	
0.15 (0.1–0.2)	≤ 2.0	0.2 (0.15–0.25)	≤ 3.0	0.2 (0.15–0.25)	≤ 4.0	0.25 (0.2–0.3)	≤ 5.0
0.15 (0.1–0.2)	≤ 2.0	0.2 (0.15–0.25)	≤ 3.0	0.2 (0.15–0.25)	≤ 4.0	0.25 (0.2–0.3)	≤ 5.0
0.15 (0.1–0.2)	≤ 2.0	0.2 (0.15–0.25)	≤ 3.0	0.2 (0.15–0.25)	≤ 4.0	0.25 (0.2–0.3)	≤ 5.0
0.15 (0.1–0.2)	≤ 2.0	0.2 (0.15–0.25)	≤ 3.0	0.2 (0.15–0.25)	≤ 4.0	0.25 (0.2–0.3)	≤ 5.0
0.15 (0.1–0.2)	≤ 2.0	0.2 (0.15–0.25)	≤ 3.0	0.2 (0.15–0.25)	≤ 4.0	0.25 (0.2–0.3)	≤ 5.0
0.15 (0.1–0.2)	≤ 2.0	0.2 (0.15–0.25)	≤ 3.0	0.2 (0.15–0.25)	≤ 4.0	0.25 (0.2–0.3)	≤ 5.0
0.15 (0.1–0.2)	≤ 2.0	0.2 (0.15–0.25)	≤ 3.0	0.2 (0.15–0.25)	≤ 4.0	0.25 (0.2–0.3)	≤ 5.0
0.15 (0.1–0.2)	≤ 2.0	0.2 (0.15–0.25)	≤ 3.0	0.2 (0.15–0.25)	≤ 4.0	0.25 (0.2–0.3)	≤ 5.0
L,M Breaker		M Breaker					
0.15 (0.1–0.2)	≤ 2.0	0.2 (0.15–0.25)	≤ 3.0	–	–	–	–
0.15 (0.1–0.2)	≤ 2.0	0.2 (0.15–0.25)	≤ 3.0	–	–	–	–
0.15 (0.1–0.2)	≤ 2.0	0.2 (0.15–0.25)	≤ 3.0	–	–	–	–
0.15 (0.1–0.2)	≤ 2.0	0.2 (0.15–0.25)	≤ 3.0	–	–	–	–
0.15 (0.1–0.2)	≤ 2.0	0.2 (0.15–0.25)	≤ 3.0	–	–	–	–
0.15 (0.1–0.2)	≤ 2.0	0.2 (0.15–0.25)	≤ 3.0	–	–	–	–
0.15 (0.1–0.2)	≤ 2.0	0.2 (0.15–0.25)	≤ 3.0	–	–	–	–
L,M Breaker		M Breaker		M,R Breaker		R,H Breaker	
0.15 (0.1–0.2)	≤ 2.0	0.15 (0.1–0.2)	≤ 2.0	0.2 (0.15–0.25)	≤ 4.0	0.25 (0.2–0.3)	≤ 5.0
0.15 (0.1–0.2)	≤ 2.0	0.15 (0.1–0.2)	≤ 2.0	0.2 (0.15–0.25)	≤ 4.0	0.25 (0.2–0.3)	≤ 5.0
0.15 (0.1–0.2)	≤ 2.0	0.15 (0.1–0.2)	≤ 2.0	0.2 (0.15–0.25)	≤ 4.0	0.25 (0.2–0.3)	≤ 5.0
0.15 (0.1–0.2)	≤ 2.0	0.15 (0.1–0.2)	≤ 2.0	0.2 (0.15–0.25)	≤ 4.0	0.25 (0.2–0.3)	≤ 5.0
0.15 (0.1–0.2)	≤ 2.0	0.15 (0.1–0.2)	≤ 2.0	0.2 (0.15–0.25)	≤ 4.0	0.25 (0.2–0.3)	≤ 5.0
0.15 (0.1–0.2)	≤ 2.0	0.15 (0.1–0.2)	≤ 2.0	0.2 (0.15–0.25)	≤ 4.0	0.25 (0.2–0.3)	≤ 5.0
L Breaker		L Breaker		L Breaker		L Breaker	
0.15 (0.1–0.2)	≤ 2.0	0.2 (0.15–0.25)	≤ 3.0	0.2 (0.15–0.25)	≤ 4.0	0.25 (0.2–0.3)	≤ 5.0
L,M Breaker		M Breaker					
0.05 (0.05–0.1)	≤ 1.5	0.1 (0.05–0.15)	≤ 2.0	–	–	–	–
0.05 (0.05–0.1)	≤ 1.5	0.1 (0.05–0.15)	≤ 2.0	–	–	–	–
0.05 (0.05–0.1)	≤ 1.5	0.1 (0.05–0.15)	≤ 2.0	–	–	–	–
0.05 (0.05–0.1)	≤ 1.5	0.1 (0.05–0.15)	≤ 2.0	–	–	–	–

K

ROTATING TOOLS

ROTATING TOOLS

FACE MILLING <GENERAL CUTTING>



ASX445

- P
- M
- K
- N
- S
- H

ROTATING TOOLS

K



ø50, ø63



Over ø80

Fig.1
ø50
ø63

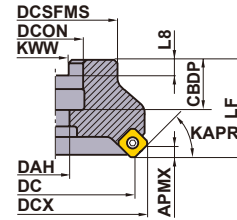

Fig.2
ø80
ø100

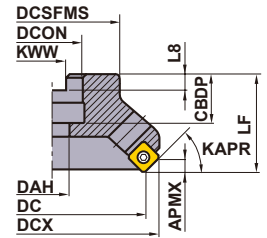

Fig.3
ø125

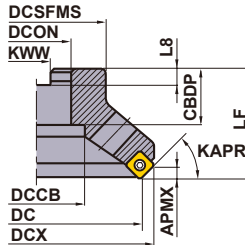

Fig.4
ø160

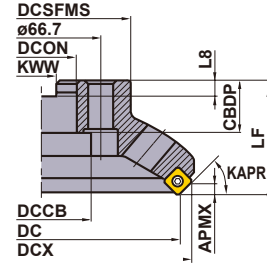
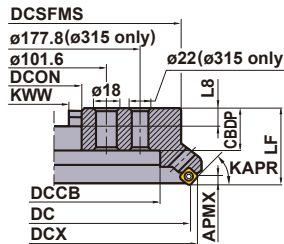

Fig.5
ø200
ø250
ø315



ARBOR TYPE

KAPR : 45°

GAMP: +20° - +23° GAMF: -13° - -10°

Right hand tool holder shown.

Type	Order Number	Stock		Number of Teeth	Dimensions (mm)									WT* (kg)	APMX (mm)	Fig.	
		R	L		DC	DCX	LF	DCON	CBDP	DAH	DCCB	DCSFMS	KWW				L8
Coarse Pitch	ASX445-050A03R	●		3	50	63.0	40	22	20	11	—	45	10.4	6.3	0.5	6	1
	ASX445-063A04R	●		4	63	75.9	40	22	20	11	—	50	10.4	6.3	0.7	6	1
	ASX445-080A04R	●		4	80	93.2	50	27	23	13	—	56	12.4	7	1.0	6	2
	ASX445-100A05R	●		5	100	113.2	50	32	26	17	—	70	14.4	8	1.6	6	2
	ASX445-125B06R	●		6	125	138.0	63	40	32	—	56	80	16.4	9	2.4	6	3
	ASX445-160C07R	●		7	160	173.0	63	40	29	—	56	100	16.4	9	3.9	6	4
	ASX445-200C08R	★		8	200	212.9	63	60	32	—	135	155	25.7	14.22	6.7	6	5
	ASX445-250C10R	★		10	250	262.9	63	60	32	—	174	200	25.7	14.22	10.5	6	5
	ASX445-315C14R	★		14	315	327.9	80	60	57	—	256.8	285	25.7	14.22	22.4	6	5
Fine Pitch	ASX445-050A04R	●		4	50	63.0	40	22	20	11	—	45	10.4	6.3	0.4	6	1
	ASX445-063A05R	●		5	63	75.9	40	22	20	11	—	50	10.4	6.3	0.6	6	1
	ASX445-080A06R/L	●	□	6	80	93.2	50	27	23	13	—	56	12.4	7	0.9	6	2
	ASX445-100A07R/L	●	□	7	100	113.2	50	32	26	17	—	70	14.4	8	1.5	6	2
	ASX445-125B08R/L	●	□	8	125	138.0	63	40	32	—	56	80	16.4	9	2.3	6	3
	ASX445-160C10R	●		10	160	173.0	63	40	29	—	56	100	16.4	9	3.6	6	4
	ASX445-200C12R/L	●	□	12	200	212.9	63	60	32	—	135	155	25.7	14.22	5.8	6	5
	ASX445-250C14R/L	★	□	14	250	262.9	63	60	32	—	174	200	25.7	14.22	10.6	6	5
	ASX445-315C18R/L	★	□	18	315	327.9	80	60	57	—	256.8	285	25.7	14.22	22.2	6	5
Extra Fine Pitch	ASX445-050A05R	●		5	50	63.0	40	22	20	11	—	45	10.4	6.3	0.4	6	1
	ASX445-063A06R	●		6	63	75.9	40	22	20	11	—	50	10.4	6.3	0.6	6	1
	ASX445-080A08R	●		8	80	93.2	50	27	23	13	—	56	12.4	7	0.9	6	2
	ASX445-100A10R/L	●	□	10	100	113.2	50	32	26	17	—	70	14.4	8	1.5	6	2
	ASX445-125B12R	●		12	125	138.0	63	40	32	—	56	80	16.4	9	2.3	6	3
	ASX445-160C16R	●		16	160	173.0	63	40	29	—	56	100	16.4	9	3.6	6	4
	ASX445-200C20R	★		20	200	212.9	63	60	32	—	135	155	25.7	14.22	6.5	6	5
	ASX445-250C24R	★		24	250	262.9	63	60	32	—	174	200	25.7	14.22	10.3	6	5
	ASX445-315C28R	★		28	315	327.9	80	60	57	—	256.8	285	25.7	14.22	21.8	6	5

* WT : Tool Weight

● : Inventory maintained. ★ : Inventory maintained in Japan.

□ : Non stock, produced to order only.

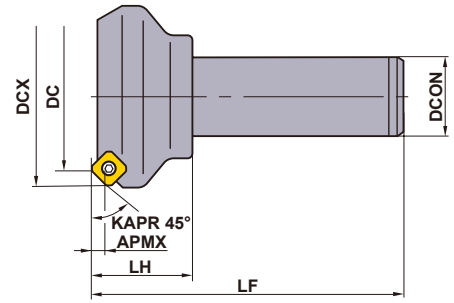
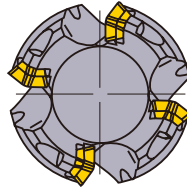

Right hand tool holder only.

SHANK TYPE

Order Number	Stock	Number of Teeth	Dimensions (mm)					APMX (mm)
	R		DC	DCX	LF	DCON	LH	
ASX445R503S32	★	3	50	63.0	125	32	40	6
ASX445R634S32	★	4	63	75.9	125	32	40	6

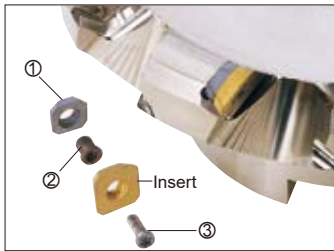

SPARE PARTS

Tool Holder Number	① Shim	② Shim Screw *	③ Clamp Screw *	Wrench (Insert)	Wrench (Shim)
ASX445	STASX445N	WCS503507H	TPS35	TIP15T	HKY35R

* Clamp Torque (N • m) : WCS503507H=5.0, TPS35=3.5

Wrench	<p>1. Wrench The ASX445 uses a TORXPLUS clamp screw. The attached wrench is for the exclusive use of this screw. To ensure the effectiveness of TORXPLUS only use the attached wrench.</p> <p>2. Hexagonal wrench The attached hexagonal wrench is for use with the seat and the shim. The wrench size is 3.5mm.</p>
Spare Parts	Only use the original parts that were supplied when purchased. If other parts are used the performance and safety can not be assured.

ROTATING TOOLS

INSERTS

Work Material	P	Steel													Cutting Conditions (Guide) :								
	M	Stainless Steel													● : Stable Cutting ● : General Cutting ✚ : Unstable Cutting								
Work Material	K	Cast Iron													Honing :								
	N	Non-ferrous Metal													E : Round F : Sharp								
	S	Heat-resistant Alloy, Titanium Alloy													S : Chamfer + Hone T : Chamfer								
Application	Shape	Order Number	Class	Honing	Coated										Cermet	Carbide	Dimensions (mm)				Geometry		
					F7030	MC5020	MP6120	MP6130	MP7130	MP7140	MP9120	MP9130	VP15TF	VP30RT	VP45N	NX4545	HTT10	IC	S	BS		RE	
ROTATING TOOLS K	JL Breaker	SEET13T3AGEN-JL	E	E	●	●	●	●	●	●	●	●	●	●	●	●	●	●	13.4	3.97	1.9	1.5	
	JM Breaker	SEMT13T3AGSN-JM	M	S	●	●	●	●	●	●	●	●	●	●	●	●	●	●	13.4	3.97	1.9	1.5	
	JH Breaker	SEMT13T3AGSN-JH	M	S	●	●	●	●	●	●	●	●	●	●	●	●	●	●	13.4	3.97	1.9	1.5	
	FT Breaker	SEMT13T3AGSN-FT	M	S	●														13.4	3.97	1.9	1.5	
	JP Breaker	SEGT13T3AGFN-JP	G	F														●	13.4	3.97	2.2	—	

Instructions for use of the JP breaker

Note 1) The JP breaker has sharp cutting edges. Wear gloves when handling.

Note 2) When machining aluminium alloy, welding to the cutting edge tends to occur, often leading to insert failure.

Note 3) Wet cutting is recommended.

● : Inventory maintained. (10 inserts in one case)

(CBN and PCD wiper inserts are available in 1 piece in one case)

WIPER INSERTS

Work Material	P	Steel	●	●	●									Cutting Conditions (Guide) : ● : Stable Cutting ● : General Cutting ✖ : Unstable Cutting Honing : E : Round F : Sharp S : Chamfer + Hone T : Chamfer			
	M	Stainless Steel	●	●	●												
K	Cast Iron	●	✖	●	●												
N	Non-ferrous Metal					●											
S	Heat-resistant Alloy, Titanium Alloy		●														
H	Hardened Steel		●														
Shape	Order Number	Class	Honing	Coated	Cermet	Coated Cermet	Carbide	CBN	PCD	Dimensions (mm)						Geometry	
				MC5020	VP15TF	NX2525	VP25N	HT105T	MB710	MD220	L	LE	W1	S	BS		RE
	WEEW13T3AGER8C	E	E	●	●						16.6	—	16.48	3.97	7.5	1.5	
	WEEW13T3AGTR8C	E	T		●	●					16.6	—	16.48	3.97	7.5	1.5	
	WEEW13T3AGFR3C	E	F						●		16.6	1.8	16.48	3.97	3.0	1.5	
	WEEW13T3AGTR3C	E	T						●		16.6	1.8	16.48	3.97	3.0	1.5	

Note 1) Wiper inserts are single-cornered.
 Note 2) CBN grade MB710 is for cast iron.
 Note 3) PCD grade MD220 is for aluminium alloy.

INSTRUCTIONS FOR USE OF WIPER INSERTS



Fig.1



Fig.2

Note 1) These wiper inserts are single-cornered.
 Note 2) Install the insert so that the cutting edge is located as shown in Fig. 1.
 Do not install the wiper insert as shown in Fig. 2. (The insert may be damaged by a too heavy cutting load.)
 Note 3) Recommended depth of cut is $ap=0.2-0.5$ (mm). (Be aware of the cutting load if the depth of cut is over the recommendation.)
 Note 4) The major cutting edge of a wiper insert is set further inside than a standard insert.
 This is to prevent heavy loads on the wiper insert. (To prevent fracture set the feed under 0.2 mm/t.)
 Note 5) Excellent finished surface can be obtained with one wiper insert.
 Note 6) When the feed per revolution is larger than the width of the wiper edge, install 2 or more wiper inserts equally spaced inside the cutting body.

RECOMMENDED CUTTING CONDITIONS WHEN USING A WIPER INSERT

Work Material	Grade	Recommended Cutting Speed (m/min)
P	VP25N	200 (80–250)
	VP15TF	180 (80–250)
M	VP15TF	120–270
K	MC5020	130–250
	VP15TF	
S	VP15TF	20–50
	VP15TF	40–80
N	MD220	650 (300–1000)

● Recommended depth of cut (ap) is 0.2mm-0.5mm and feed per tooth (fz) is up to 0.2mm/t.

SPARE PARTS > N001
 TECHNICAL DATA > P001

ROTATING TOOLS

RECOMMENDED CUTTING CONDITIONS

	Work Material	Hardness	Grade	Cutting Speed (m/min)	Finish—Light Cutting		Light—Rough Cutting		Medium—Heavy Cutting	
					Feed per Tooth (mm/t)	Breaker	Feed per Tooth (mm/t)	Breaker	Feed per Tooth (mm/t)	Breaker
K ROTATING TOOLS	P Mild Steel	≤180HB	F7030	280 (210—350)	0.15 (0.1—0.2)	JL	0.2 (0.1—0.3)	JM	0.3 (0.2—0.4)	JH
			MP6120 VP15TF	250 (200—300)	0.15 (0.1—0.2)	JL	0.2 (0.1—0.3)	JM	0.3 (0.2—0.4)	JH
			MP6130	240 (190—290)	0.15 (0.1—0.2)	JL	0.2 (0.1—0.3)	JM	0.3 (0.2—0.4)	JH
			VP30RT	230 (180—280)	0.15 (0.1—0.2)	JL	0.2 (0.1—0.3)	JM	0.3 (0.2—0.4)	JH
			NX4545	180 (130—230)	0.15 (0.1—0.2)	JL	0.2 (0.1—0.3)	JM	—	—
	Carbon Steel Alloy Steel	180—280HB	F7030	250 (200—300)	0.15 (0.1—0.2)	JL	0.2 (0.1—0.3)	JM	0.3 (0.2—0.4)	JH
			MP6120 VP15TF	220 (170—270)	0.15 (0.1—0.2)	JL	0.2 (0.1—0.3)	JM	0.3 (0.2—0.4)	JH
			MP6130	200 (150—230)	0.15 (0.1—0.2)	JL	0.2 (0.1—0.3)	JM	0.3 (0.2—0.4)	JH
			VP30RT	150 (120—180)	0.15 (0.1—0.2)	JL	0.2 (0.1—0.3)	JM	0.3 (0.2—0.4)	JH
			NX4545	150 (120—180)	0.15 (0.1—0.2)	JL	0.2 (0.1—0.3)	JM	—	—
		280—350HB	F7030	180 (130—230)	0.15 (0.1—0.2)	JL	0.2 (0.1—0.3)	JM	0.3 (0.2—0.4)	JH
			MP6120 VP15TF	140 (100—180)	0.15 (0.1—0.2)	JL	0.2 (0.1—0.3)	JM	0.3 (0.2—0.4)	JH
			MP6130	120 (90—150)	0.15 (0.1—0.2)	JL	0.2 (0.1—0.3)	JM	0.3 (0.2—0.4)	JH
			VP30RT	100 (80—160)	0.15 (0.1—0.2)	JL	0.2 (0.1—0.3)	JM	0.3 (0.2—0.4)	JH
			NX4545	100 (80—160)	0.15 (0.1—0.2)	JL	0.2 (0.1—0.3)	JM	—	—
M Stainless Steel	≤270HB	MP7130 VP15TF	220 (170—270)	0.15 (0.1—0.2)	JL	0.2 (0.1—0.3)	JM	0.3 (0.2—0.4)	JH	
		MP7140 VP30RT	200 (150—250)	0.15 (0.1—0.2)	JL	0.2 (0.1—0.3)	JM	0.3 (0.2—0.4)	JH	
		NX4545	150 (120—180)	0.15 (0.1—0.2)	JL	0.2 (0.1—0.3)	JM	—	—	
K Cast Iron Ductile Cast Iron	Tensile Strength ≤450MPa	MC5020	200 (150—250)	—	—	0.2 (0.1—0.3)	JM	0.3 (0.2—0.4)	JH FT	
	Tensile Strength ≥450MPa	VP15TF	180 (130—250)	0.15 (0.1—0.2)	JL	0.2 (0.1—0.3)	JM	0.3 (0.2—0.4)	JH	
		MC5020	110 (80—150)	—	—	0.2 (0.1—0.3)	JM	0.3 (0.2—0.4)	JH FT	
N Aluminium Alloy	—	HTi10	650 (300—1000)	0.15 (0.1—0.2)	JP	0.2 (0.1—0.3)	JP	0.3 (0.2—0.4)	JP	
S Titanium Alloy Heat Resistant Alloy (Inconel718 etc.)	—	MP9120 VP15TF	50 (40—60)	0.15 (0.1—0.2)	JL	0.2 (0.1—0.3)	JM	0.3 (0.2—0.4)	JH	
		MP9130	45 (30—55)	0.15 (0.1—0.2)	JL	0.2 (0.1—0.3)	JM	0.3 (0.2—0.4)	JH	
	—	MP9120 VP15TF	40 (20—50)	0.15 (0.1—0.2)	JL	0.2 (0.1—0.3)	JM	0.3 (0.2—0.4)	JH	
		MP9130	35 (15—45)	0.15 (0.1—0.2)	JL	0.2 (0.1—0.3)	JM	0.3 (0.2—0.4)	JH	
H Hardened Steel	40—55HRC	VP15TF	80 (60—100)	0.1 (0.05—0.15)	JL	0.15 (0.1—0.2)	JM	0.2 (0.1—0.3)	JH	

● Revolution (min⁻¹)=(1000 x Cutting Speed)÷(3.14 x DC)

● Table Feed (mm/min)=Feed per Tooth x Number of Teeth x Cutter Revolution

FEATURES

■ STABLE, LONG TOOL LIFE, HIGH ACCURACY BODY

<p>A carbide shim with Mitsubishi's proprietary Anti-Fly Insert (AFI) mechanism provides excellent insert location characteristics, permitting stable cutting even under high load conditions.</p> 	<p>The cutter body is made from a special alloy that provides high strength at high temperature. A special surface treatment improves the corrosion resistance.</p> 	<p>The ASX cutter uses screw-on type inserts that allow easy clamping of the inserts with high location precision. Indexing of the inserts can be performed without completely removing the screw.</p> 
--	---	--

■ EFFECTIVE FOR VARIOUS MACHINING APPLICATIONS

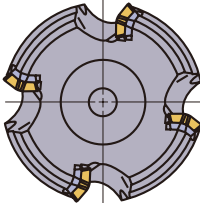
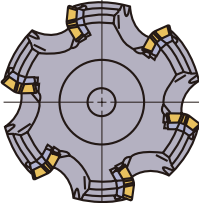
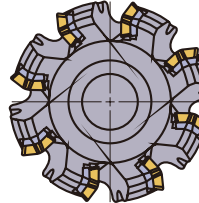
<p>● Coarse Pitch Type</p> <ol style="list-style-type: none"> 1st recommendation for cutting steels and stainless steels. For deep cutting and high feed rates with large-volume chip discharge. Smooth cutting allows longer overhang applications. 	<p>● Fine Pitch Type</p> <ol style="list-style-type: none"> 1st recommendation for cast iron, hardened steel and heat-resistant alloys. For shallow cutting with low feed rates and low-volume chip discharge. 	<p>● Extra Fine Pitch Type</p> <ol style="list-style-type: none"> 1st recommendation for cast iron. For cutting operations where chip discharge volume is small and high table feed is desired. 
---	--	---

■ CHIPBREAKERS FOR A WIDE RANGE OF APPLICATIONS

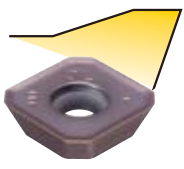
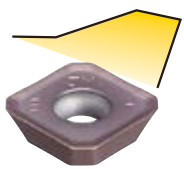
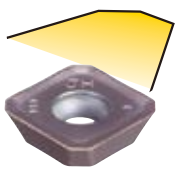
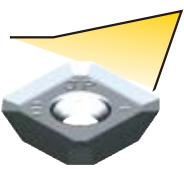
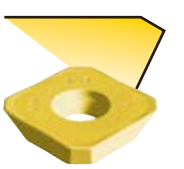
JL Finish to Light Cutting Breaker	JM Light to Semi-Heavy Cutting Breaker	JH Medium to Heavy Cutting Breaker	JP Aluminium Alloy Cutting Breaker	FT Rough Cutting for Cast Iron Breaker
				
<p>High accuracy insert with ground finished periphery. Large rake angle leading to low cutting resistance.</p> <p>① Workpiece rigidity is low.</p>	<p>High accuracy M class insert. For a wide range of work materials and cutting conditions.</p> <p>① General cutting.</p>	<p>High accuracy M class insert. Strong cutting edge for high fracture resistance.</p> <p>① Interrupted cutting. ② Scaling.</p>	<p>High accuracy insert with ground finished periphery. Large rake angle and mirror finished rake face for sharp cutting performance and high welding resistance.</p> <p>① General machining of aluminium and non ferrous metal.</p>	<p>High M class inserts. Higher fracture-resistant flat-top inserts.</p> <p>① For rough accuracy machining of scaled cast iron.</p>

■ INSERT GRADES FOR A WIDE RANGE OF MATERIALS

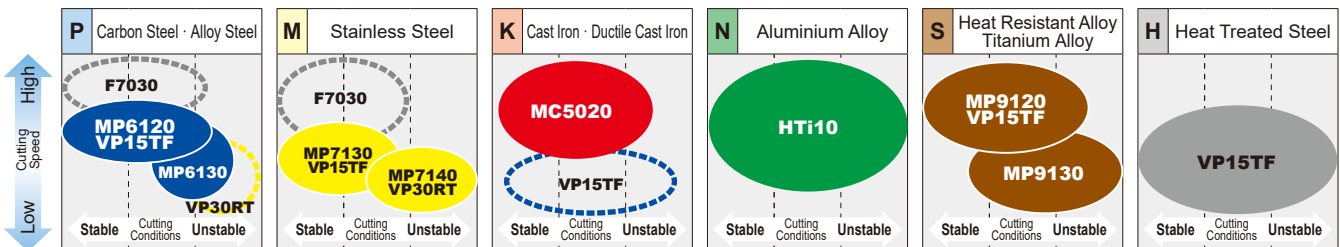

Note 1) When machining steel or stainless steel where the emphasis is on surface finish, use the cermet grade NX4545.

Stable Cutting: Continuous cutting, Constant depth of cut, Pre-machined securely clamped component cutting

Unstable Cutting: Heavy interrupted, Irregular depth of cut, Low clamping rigidity cutting

FACE MILLING

<GENERAL CUTTING>

AHX440S/475S/640S

Selection Reference Table (Cutting Edge Count and Cutting Conditions)

DC	Type	Number of Teeth	AHX440S			AHX475S			AHX640S		
			General Cutting			High Feed Machining			General Cutting		
			Stock	fr (mm/rev)	APMX	Stock	fr (mm/rev)	APMX	Stock	fr (mm/rev)	APMX
40	Fine Pitch	3	●	0.6-1.2	3						
	Extra Fine Pitch	4	●	0.8-1.6	3						
50	Fine Pitch	4	●	0.8-1.6	3	●	2.4-4.0	1.6			
	Extra Fine Pitch	5	●	1.0-2.0	3	●	3.0-5.0	1.6			
	Super Extra Fine Pitch	6	●	1.2-2.4	3						
63	Coarse Pitch	4							●	0.8-1.6	6
	Fine Pitch	5	●	1.0-2.0	3	●	3.0-5.0	1.6	●	1.0-2.0	6
	Extra Fine Pitch	6	●	1.2-2.4	3	●	3.6-6.0	1.6			
	Super Extra Fine Pitch	8	●	1.6-3.2	3						
80	Coarse Pitch	4							●	0.8-1.6	6
	Fine Pitch	6	●	1.2-2.4	3	●	3.6-6.0	1.6	●	1.2-2.4	6
	Extra Fine Pitch	8	●	1.6-3.2	3	●	4.8-8.0	1.6			
	Super Extra Fine Pitch	10	●	2.0-4.0	3						
100	Coarse Pitch	5							●	1.0-2.0	6
	Fine Pitch	7	●	1.4-2.8	3	●	4.2-7.0	1.6	●	1.4-2.8	6
	Extra Fine Pitch	9				●	5.4-9.0	1.6			
	Super Extra Fine Pitch	12	●	2.0-4.0	3						
125	Coarse Pitch	6							●	1.2-2.4	6
	Fine Pitch	8	●	1.6-3.2	3	●	4.8-8.0	1.6	●	1.6-3.2	6
	Extra Fine Pitch	10				●	6.0-10.0	1.6			
	Super Extra Fine Pitch	14	●	2.4-4.8	3						
160	Coarse Pitch	7							●	1.4-2.8	6
	Fine Pitch	10	●	2.0-4.0	3	●	6.0-10.0	1.6	●	2.0-4.0	6
	Extra Fine Pitch	12				●	7.2-12.0	1.6			
	Super Extra Fine Pitch	14	●	2.8-5.6	3						
200	Coarse Pitch	8							●	1.6-3.2	6
	Fine Pitch	12							●	2.4-4.8	6

Note 1) fr : Feed rate per revolution (AHX475S : the feed rate per cutter (fz) will be limited by the cutting width ae. Please refer to page K040 for details.)

Note 2) APMX : Maximum depths of cut (AHX440S : the maximum depths of cut will vary depending on the breaker)

Note 3) The depths of cut and feed rate are identical to the recommended conditions for carbon steel and alloy steel.

Compatibility with Inserts for AHX Series

The RE = 3.2 mm insert for use with AHX440S can be mounted on AHX475S.

All inserts for use with AHX640 can be mounted on AHX640S (note, however, that the set height will differ). The inserts for mounting on AHX640W are the MK, HK, and WK breakers.

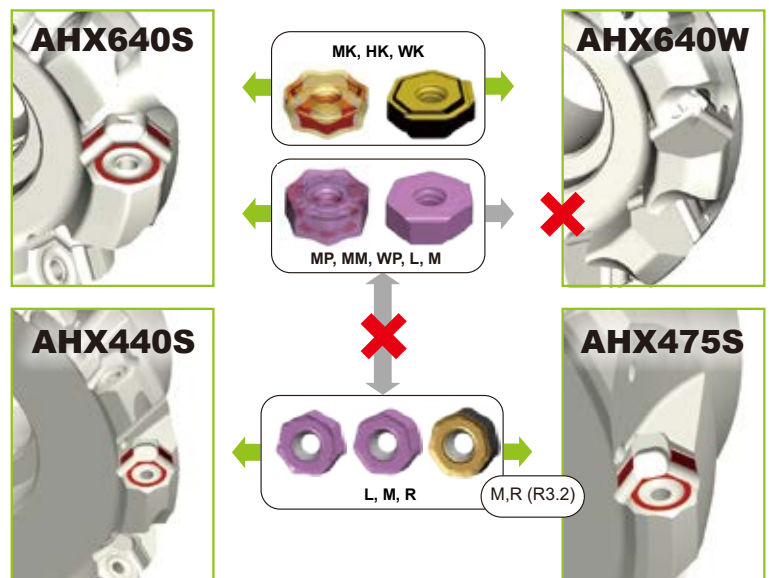

Breaker System

Breaker Series for Varied Cutting Conditions

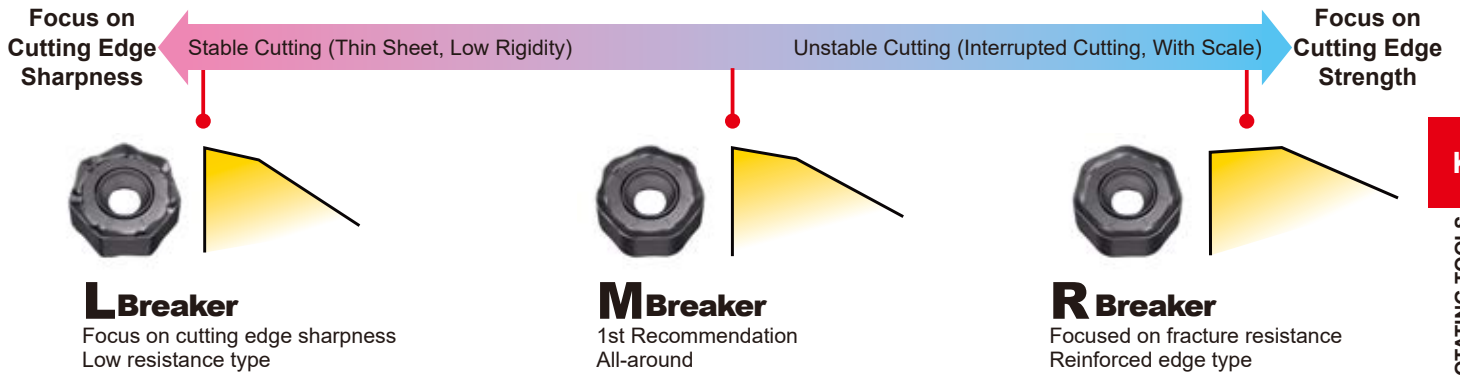

Work Material	Cutting Conditions		
	Stable Cutting	General Cutting	Unstable Cutting
P	AHX440S	M (R0.8) With Wiper	M (R3.2) Shared with AHX475
	AHX640S	MP	R Shared with AHX475
M	AHX440S	L With Wiper	M (R0.8) With Wiper
	AHX640S	MM	R
K	AHX440S	L With Wiper	M (R0.8) With Wiper
	AHX640S	MK	R Shared with AHX475

Wiper Insert of AHX640S

Based on the number of inserts and the cutting conditions, use of wiper inserts can improve overall surface finishes.



WP + combination with **MP**
Right-hand 2 corners, left-hand 2 corners.



WK + combination with **MK**
Right-hand 2 corners, left-hand 2 corners.



ROTATING TOOLS

FACE MILLING <GENERAL CUTTING>



AHX440S

- P
- M
- K
- N
- S
- H

ROTATING TOOLS

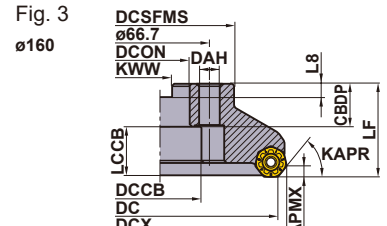
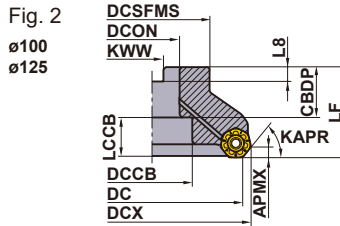
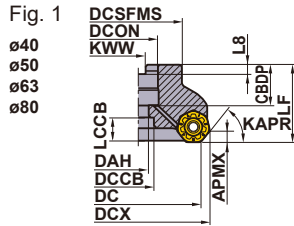

KAPR : 50°
GAMP: -6° GAMF: -7°

Right hand tool holder only.

DC (mm)	Order Number	Stock	Coolant Hole	Number of Teeth	Dimensions (mm)			Fig.	WT* (kg)	APMX (mm)
					LF	DCX	DCON			
40	AHX440S-040A03AR	●	○	3	40	48.4	16	1	0.3	3
	AHX440S-040A04AR	●	○	4	40	48.4	16	1	0.2	3
50	AHX440S-050A04AR	●	○	4	40	58.4	22	1	0.4	3
	AHX440S-050A05AR	●	○	5	40	58.4	22	1	0.4	3
	AHX440S-050A06AR	●	○	6	40	58.4	22	1	0.4	3
63	AHX440S-063A05AR	●	○	5	40	71.4	22	1	0.6	3
	AHX440S-063A06AR	●	○	6	40	71.4	22	1	0.6	3
	AHX440S-063A08AR	●	○	8	40	71.4	22	1	0.5	3
80	AHX440S-080A06AR	●	○	6	50	88.4	27	1	1.1	3
	AHX440S-080A08AR	●	○	8	50	88.4	27	1	1.1	3
	AHX440S-080A10AR	●	○	10	50	88.4	27	1	1.1	3
100	AHX440S-100B07AR	●	○	7	50	108.4	32	2	1.6	3
	AHX440S-100B10AR	●	○	10	50	108.4	32	2	1.6	3
	AHX440S-100B12AR	●	○	12	50	108.3	32	2	1.6	3
125	AHX440S-125B08AR	●	○	8	63	133.4	40	2	3.0	3
	AHX440S-125B12AR	●	○	12	63	133.4	40	2	3.0	3
	AHX440S-125B14AR	●	○	14	63	133.3	40	2	2.9	3
160	AHX440S-160C10NR	●	—	10	63	168.4	40	3	4.8	3
	AHX440S-160C14NR	●	—	14	63	168.4	40	3	4.6	3
	AHX440S-160C16NR	●	—	16	63	168.4	40	3	4.7	3

Note 1) The cutter body does not have a set bolt for an arbor. Please order the Set Bolt separately.

Note 2) The above "APMX" will vary depending on the breaker insert.

* WT : Tool Weight

SPARE PARTS

Tool Holder Number	Clamp Screw	Wrench (Insert)
AHX440S	TS35R	TKY15T

* Clamp Torque (N · m) : TS35R=3.5

SET BOLT (SOLD SEPARATELY)

Tool Holder Number	Set Bolt		Fig.	Reference Dimensions (mm)							Geometry
	With Coolant Hole	Without Coolant Hole		a	b	c	d	e	f	g	
	Order Number	Order Number									
AHX440S-040A03AR	HSC08025H	HSC08040	1	13	M8×1.25	33	8	5	—	—	Fig.1
AHX440S-050A04AR	HSC10030H	HSC10035	1	16	M10×1.5	40	10	6	—	—	
AHX440S-063A05AR	HSC10030H	HSC10035	1	16	M10×1.5	40	10	6	—	—	
AHX440S-080A06AR	HSC12035H	HSC12035 (HSC12045)	1	18	M12×1.75	47 57	12	10	—	—	Fig.2
AHX440S-100B07AR	MBA16033H	—	2	40	M16×2	43	10	14	6	23	
AHX440S-125B08AR	MBA20040H	—	2	50	M20×2.5	54	14	17	6	27	
AHX440S-160C10NR	No coolant hole	—	2	50	M20×2.5	54	14	17	6	27	

Note 1) Internal coolant is necessary with the set bolt.

● : Inventory maintained. ★ : Inventory maintained in Japan.

INSERTS

Work Material		P	Steel		Cutting Conditions (Guide) :					Honing :						
		M	Stainless Steel		● : Stable Cutting ● : General Cutting ✖ : Unstable Cutting					E : Round						
K	Cast Iron															
H	Hardened Steel															
Application	Shape	Order Number	Class	Honing	Coated						Dimensions (mm)					Geometry
					MP6120	MP6130	MP7130	MP7140	MC5020	VP15TF	IC	RE	BS	S	APMX	
Stable Cutting		NNMU130508ZER-L	M	E	●	●	●	●	●	★	13.4	0.8	1	5.77	3	
General Cutting		NNMU130508ZEN-M	M	E	●	●	●	●	●	★	13.4	0.8	1	5.57	* 4	
		NNMU130532ZEN-M	M	E	●	●	●	●	●	★	13.4	3.2	—	5.57	* 4	
Unstable Cutting		NNMU130532ZEN-R	M	E	●	●	●	●	●	★	13.4	3.2	—	5.47	* 4	
Finish Cutting		WNEU1305ZEN4C-M	E	E	●					★	13.4	2.7	4	5.1	0.5	

* When not using the Wiper, APMX = 3.5mm



Corner R on Opposite Side

If using corner R on the opposite side, APMX = 4.0 mm
 If not using the opposite corner, APMX = 3.5 mm

INSTRUCTIONS FOR USE OF WIPER INSERTS

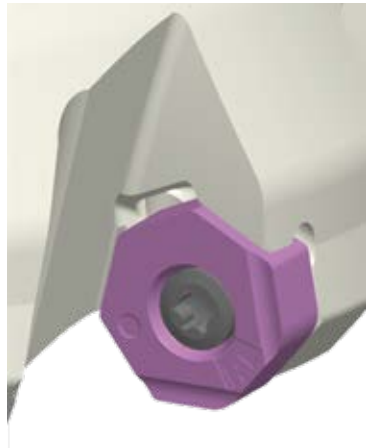

Fig.1



Fig.2

Note 1) These wiper inserts have 2 corners on right hand type and 2 corners for left hand type. Refer to Figure 1.

Note 2) A satisfactory finish surface can be achieved with one wiper insert. However, if the feed rate per revolution will be equal to or greater than the width of the wiper edge, it is recommended to install 2 or more wiper inserts spaced evenly within the cutting body.

MOUNTING DIMENSION	> K046
SPARE PARTS	> N001
TECHNICAL DATA	> P001

ROTATING TOOLS

RECOMMENDED CUTTING CONDITIONS

■ Dry Cutting

Work Material	Hardness	Grade	Vc (m/min)	fz (mm/t.)	ap (mm)	
P Mild Steel	≤180HB	MP6120,VP15TF	250(200–300)	0.3(0.2–0.4)	≤3	
		MP6130	240(190–290)	0.3(0.2–0.4)	≤3	
	Carbon Steel, Alloy Steel	180–280HB	MP6120,VP15TF	220(170–270)	0.3(0.2–0.4)	≤3
			MP6130	200(150–250)	0.3(0.2–0.4)	≤3
	Carbon Steel, Alloy Steel	280–350HB	MP6120,VP15TF	140(100–180)	0.3(0.2–0.4)	≤3
			MP6130	120(90–150)	0.3(0.2–0.4)	≤3
	Alloy Tool Steel	≤350HB (Annealing)	MP6120,VP15TF	140(100–180)	0.15(0.1–0.2)	≤1
			MP6130	120(90–150)	0.15(0.1–0.2)	≤1
Pre-hardened Steel	35–45HRC	MP6120,VP15TF	140(100–180)	0.15(0.1–0.2)	≤1	
		MP6130	120(90–150)	0.15(0.1–0.2)	≤1	
M Austenitic Stainless Steel	≤200HB	MP7130,VP15TF	200(150–250)	0.2(0.1–0.3)	≤3	
		MP7140	180(120–230)	0.2(0.1–0.3)	≤3	
		MP7130,VP15TF	150(100–200)	0.2(0.1–0.3)	≤3	
		MP7140	130(80–180)	0.2(0.1–0.3)	≤3	
	> 200HB	MP7130,VP15TF	200(150–250)	0.2(0.1–0.3)	≤3	
		MP7140	180(120–230)	0.2(0.1–0.3)	≤3	
		MP7130,VP15TF	150(100–200)	0.2(0.1–0.3)	≤3	
		MP7140	130(80–180)	0.2(0.1–0.3)	≤3	
	Ferritic and Martensitic Stainless Steel	≤200HB	MP7130,VP15TF	140(100–180)	0.15(0.05–0.25)	≤3
			MP7140	120(80–160)	0.15(0.05–0.25)	≤3
		> 200HB	MP7130,VP15TF	130(100–160)	0.15(0.05–0.25)	≤3
			MP7140	110(80–140)	0.15(0.05–0.25)	≤3
Two-phase Stainless Steel	≤280HB	MP7130,VP15TF	140(100–180)	0.15(0.05–0.25)	≤3	
		MP7140	120(80–160)	0.15(0.05–0.25)	≤3	
Precipitation Hardening Stainless Steel	< 450HB	MP7130,VP15TF	130(100–160)	0.15(0.05–0.25)	≤3	
		MP7140	110(80–140)	0.15(0.05–0.25)	≤3	
K Gray Cast Iron	Tensile Strength ≤350MPa	MC5020	220(150–300)	0.3(0.2–0.4)	≤3	
		VP15TF	180(130–230)	0.3(0.2–0.4)	≤3	
	Ductile Cast Iron	Tensile Strength ≤450MPa	MC5020	200(150–250)	0.2(0.1–0.3)	≤3
			VP15TF	170(120–220)	0.2(0.1–0.3)	≤3
	Ductile Cast Iron	Tensile Strength ≤800MPa	MC5020	170(150–200)	0.2(0.1–0.3)	≤3
			VP15TF	140(100–180)	0.2(0.1–0.3)	≤3
H Hardened Steel	40–55HRC	VP15TF	80(60–100)	0.15(0.1–0.2)	≤1	

■ Wet Cutting

Work Material	Hardness	Grade	Vc (m/min)	fz (mm/t.)	ap (mm)
M Austenitic Stainless Steel	≤200HB	MP7130,VP15TF	125(100–150)	0.15(0.1–0.2)	≤3
		MP7140	100(80–140)	0.15(0.1–0.2)	≤3
		MP7130,VP15TF	100(75–125)	0.15(0.1–0.2)	≤3
		MP7140	80(55–105)	0.15(0.1–0.2)	≤3
	> 200HB	MP7130,VP15TF	125(100–150)	0.15(0.1–0.2)	≤3
		MP7140	100(80–140)	0.15(0.1–0.2)	≤3
		MP7130,VP15TF	100(75–125)	0.15(0.1–0.2)	≤3
		MP7140	80(55–105)	0.15(0.1–0.2)	≤3
Ferritic and Martensitic Stainless Steel	≤200HB	MP7130,VP15TF	80(60–100)	0.1(0.05–0.15)	≤3
		MP7140	60(40–80)	0.1(0.05–0.15)	≤3
	> 200HB	MP7130,VP15TF	70(50–90)	0.1(0.05–0.15)	≤3
		MP7140	50(30–70)	0.1(0.05–0.15)	≤3
Two-phase Stainless Steel	≤280HB	MP7130,VP15TF	70(50–90)	0.1(0.05–0.15)	≤3
		MP7140	50(30–70)	0.1(0.05–0.15)	≤3
Precipitation Hardening Stainless Steel	< 450HB	MP7130,VP15TF	70(50–90)	0.1(0.05–0.15)	≤3
		MP7140	50(30–70)	0.1(0.05–0.15)	≤3

■ Cutting Conditions with Wiper Insert

	Work Material	Hardness	Grade	Vc (m/min)	fz (mm/t.)	ap (mm)
P	Mild Steel	≤180HB	MP6120,VP15TF	250(200–300)	0.3(0.2–0.4)	≤0.5
	Carbon Steel, Alloy Steel	180–280HB	MP6120,VP15TF	220(170–270)	0.3(0.2–0.4)	≤0.5
		280–350HB	MP6120,VP15TF	140(100–180)	0.3(0.2–0.4)	≤0.5
	Alloy Tool Steel	≤350HB (Annealing)	MP6120,VP15TF	140(100–180)	0.15(0.1–0.2)	≤0.5
	Pre-hardened Steel	35–45HRC	MP6120,VP15TF	140(100–180)	0.15(0.1–0.2)	≤0.5
M	Austenitic Stainless Steel	≤200HB	VP15TF	125(100–150)	0.15(0.1–0.2)	≤0.5
		> 200HB	VP15TF	100(75–125)	0.15(0.1–0.2)	≤0.5
	Ferritic and Martensitic Stainless Steel	≤200HB	VP15TF	125(100–150)	0.15(0.1–0.2)	≤0.5
		> 200HB	VP15TF	100(75–125)	0.15(0.1–0.2)	≤0.5
	Two-phase Stainless Steel	≤280HB	VP15TF	80(60–100)	0.1(0.05–0.15)	≤0.5
Precipitation Hardening Stainless Steel	< 450HB	VP15TF	70(50–90)	0.1(0.05–0.15)	≤0.5	
K	Gray Cast Iron	Tensile Strength ≤350MPa	MC5020	320(250–400)	0.3(0.2–0.4)	≤0.5
			VP15TF	220(150–300)	0.3(0.2–0.4)	≤0.5
	Ductile Cast Iron	Tensile Strength ≤450MPa	MC5020	250(200–300)	0.2(0.1–0.3)	≤0.5
			VP15TF	200(150–250)	0.2(0.1–0.3)	≤0.5
		Tensile Strength ≤800MPa	MC5020	220(200–250)	0.2(0.1–0.3)	≤0.5
			VP15TF	170(150–200)	0.2(0.1–0.3)	≤0.5
H	Hardened Steel	40–55HRC	VP15TF	80(60–100)	0.15(0.1–0.2)	≤0.5

Note 1) Refer to the above table and set up cutting conditions according to the applications.

Note 2) When placing emphasis on surface finish quality, wet cutting is recommended. (tool life is lowered compared to dry cutting)

Note 3) The recommended depth of cut differs according to the insert geometry.

Note 4) When clamp rigidity is low and tool overhang is long, we recommend to reduce the cutting speed and the feed rate by 30%.

Note 5) Wet cutting is recommended for good surface finishes when machining stainless steel. (Tool life is short compared to dry cutting.)

ROTATING TOOLS

FACE MILLING

<GENERAL HIGH FEED CUTTING>

15°
KAPR



AHX475S

P M **K** N S H



Fig.1

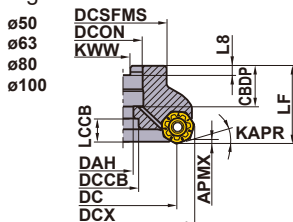
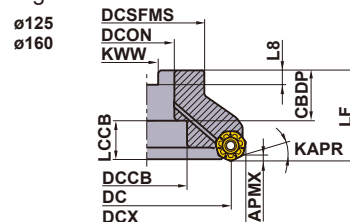

Fig.2



Right hand tool holder only.

ROTATING TOOLS



KAPR : 15°
GAMP : -6° GAMF : -10°

DC (mm)	Order Number	Stock	Coolant Hole	Number of Teeth	Dimensions (mm)			Fig.	WT [*] (kg)	APMX (mm)
					LF	DCX	DCON			
50	AHX475S-050A04AR	●	○	4	50	65.7	22	1	0.6	1.6
	AHX475S-050A05AR	●	○	5	50	65.7	22	1	0.6	1.6
63	AHX475S-063A05AR	●	○	5	50	78.7	22	1	1.0	1.6
	AHX475S-063A06AR	●	○	6	50	78.7	22	1	1.0	1.6
80	AHX475S-080A06AR	●	○	6	50	95.6	27	1	1.6	1.6
	AHX475S-080A08AR	●	○	8	50	95.6	27	1	1.6	1.6
100	AHX475S-100A07AR	●	○	7	63	115.6	32	1	3.3	1.6
	AHX475S-100A09AR	●	○	9	63	115.6	32	1	3.3	1.6
125	AHX475S-125B08AR	●	○	8	63	140.6	40	2	4.0	1.6
	AHX475S-125B10AR	●	○	10	63	140.6	40	2	4.0	1.6
160	AHX475S-160B10AR	●	○	10	63	175.6	40	2	6.0	1.6
	AHX475S-160B12AR	●	○	12	63	175.6	40	2	6.0	1.6

Note 1) The cutter body does not have a set bolt for an arbor.

* WT : Tool Weight

SPARE PARTS

Tool Holder Number	* 	* 
	Clamp Screw	Wrench (Insert)
AHX475S	TS35R	TKY15T

* Clamp Torque (N · m) : TS35R=3.5

● : Inventory maintained. ★ : Inventory maintained in Japan.
(10 inserts in one case)

ROTATING TOOLS

RECOMMENDED CUTTING CONDITIONS

■ Dry Cutting

Work Material	Hardness	Grade	Breaker	Vc (m/min)	fz (mm/t.)	ap (mm)	ae (mm)	
P	Mild Steel	≤180HB	MP6120	R	150(100-200)	0.6	≤1.6	≤0.5DC
			MP6120	R	150(100-200)	0.8	≤1.6	0.5-0.8DC
			MP6120	M	150(100-200)	1	≤1.6	0.8-1DC
			MP6130	R	130(80-180)	0.6	≤1.6	≤0.5DC
			MP6130	R	130(80-180)	0.8	≤1.6	0.5-0.8DC
			MP6130	M	130(80-180)	1	≤1.6	0.8-1DC
	Carbon Steel, Alloy Steel	180-280HB	MP6120	R	130(80-180)	0.6	≤1.6	≤0.5DC
			MP6120	R	130(80-180)	0.8	≤1.6	0.5-0.8DC
			MP6120	M	130(80-180)	1	≤1.6	0.8-1DC
			MP6130	R	110(60-160)	0.6	≤1.6	≤0.5DC
			MP6130	R	110(60-160)	0.8	≤1.6	0.5-0.8DC
			MP6130	M	110(60-160)	1	≤1.6	0.8-1DC
	Carbon Steel, Alloy Steel	280-350HB	MP6120	R	100(50-150)	0.5	≤1.6	≤0.5DC
			MP6120	R	100(50-150)	0.6	≤1.6	0.5-0.8DC
			MP6120	R	100(50-150)	0.7	≤1.6	0.8-1DC
			MP6130	R	80(30-130)	0.5	≤1.6	≤0.5DC
			MP6130	R	80(30-130)	0.6	≤1.6	0.5-0.8DC
			MP6130	R	80(30-130)	0.7	≤1.6	0.8-1DC
	Alloy Tool Steel	≤350HB (Annealing)	MP6120	R	100(50-150)	0.5	≤1.6	≤0.5DC
			MP6120	R	100(50-150)	0.6	≤1.6	0.5-0.8DC
			MP6120	R	100(50-150)	0.7	≤1.6	0.8-1DC
			MP6130	R	80(30-120)	0.5	≤1.6	≤0.5DC
			MP6130	R	80(30-120)	0.6	≤1.6	0.5-0.8DC
			MP6130	R	80(30-120)	0.7	≤1.6	0.8-1DC
Pre-hardened Steel	35-45HRC	MP6120	R	100(70-130)	0.5	≤1.6	≤0.5DC	
		MP6120	R	100(70-130)	0.6	≤1.6	0.5-0.8DC	
		MP6120	R	100(70-130)	0.7	≤1.6	0.8-1DC	
		MP6130	R	80(50-110)	0.5	≤1.6	≤0.5DC	
		MP6130	R	80(50-110)	0.6	≤1.6	0.5-0.8DC	
		MP6130	R	80(50-110)	0.7	≤1.6	0.8-1DC	
K	Gray Cast Iron	Tensile Strength ≤350MPa	MC5020	R	150(100-200)	0.6	≤1.6	≤0.5DC
			MC5020	R	150(100-200)	0.8	≤1.6	0.5-0.8DC
			MC5020	M	150(100-200)	1	≤1.6	0.8-1DC
			VP15TF	M	120(80-160)	0.6	≤1.6	≤0.5DC
			VP15TF	M	120(80-160)	0.8	≤1.6	0.5-0.8DC
			VP15TF	M	120(80-160)	1	≤1.6	0.8-1DC
	Ductile Cast Iron	Tensile Strength ≤450MPa	MC5020	R	150(100-200)	0.6	≤1.6	≤0.5DC
			MC5020	R	150(100-200)	0.8	≤1.6	0.5-0.8DC
			MC5020	M	150(100-200)	1	≤1.6	0.8-1DC
			VP15TF	R	120(80-160)	0.6	≤1.6	≤0.5DC
			VP15TF	R	120(80-160)	0.8	≤1.6	0.5-0.8DC
			VP15TF	M	120(80-160)	1	≤1.6	0.8-1DC
	Ductile Cast Iron	Tensile Strength ≤800MPa	MC5020	R	150(100-200)	0.5	≤1.6	≤0.5DC
			MC5020	R	150(100-200)	0.6	≤1.6	0.5-0.8DC
			MC5020	R	150(100-200)	0.7	≤1.6	0.8-1DC
			VP15TF	R	120(80-160)	0.5	≤1.6	≤0.5DC
			VP15TF	R	120(80-160)	0.6	≤1.6	0.5-0.8DC
			VP15TF	R	120(80-160)	0.7	≤1.6	0.8-1DC
H	Hardened Steel	40-55HRC	VP15TF	R	70(50-90)	0.4	≤1.6	≤0.5DC
			VP15TF	R	70(50-90)	0.5	≤1.6	0.5-0.8DC
			VP15TF	R	70(50-90)	0.6	≤1.6	0.8-1DC

Note 1) When clamp rigidity is low and tool overhang is long, we recommend to reduce the cutting speed and the feed rate by 30%.

FACE MILLING

<GENERAL CUTTING>



AHX640S

- P
- M
- K
- N
- S
- H



Fig. 1
ø63
ø80

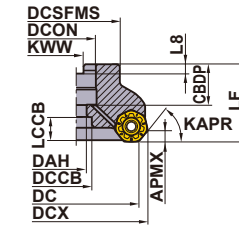

Fig. 2
ø100
ø125

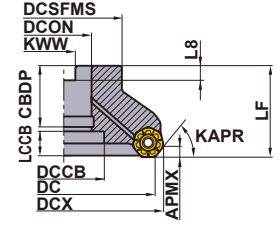

Fig. 3
ø160

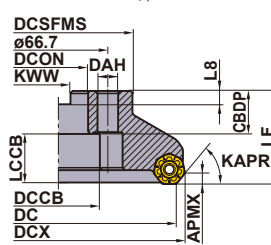
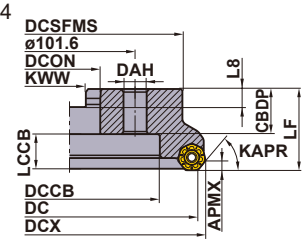

Fig. 4
ø200



Right hand tool holder only.

DC	Set Bolt	Geometry	
ø63	HSC10030H	①	
ø80	HSC12035H		
ø100	MBA16033H	②	
ø125	MBA20040H		
ø160	—	—	
ø200	—	—	

KAPR : 50°
GAMP : -6° GAMF : -5°

DC (mm)	Order Number	Stock	Coolant Hole	Number of Teeth	Dimensions (mm)			Fig.	WT* (kg)	APMX (mm)
					LF	DCX	DCON			
63	AHX640S-063A04AR	●	○	4	50	75.55	22	1	0.7	6
	AHX640S-063A05AR	●	○	5	50	75.55	22	1	0.6	6
80	AHX640S-080A04AR	●	○	4	50	92.55	27	1	1.1	6
	AHX640S-080A06AR	●	○	6	50	92.55	27	1	1.0	6
100	AHX640S-100B05AR	●	○	5	50	112.55	32	2	1.7	6
	AHX640S-100B07AR	●	○	7	50	112.55	32	2	1.6	6
125	AHX640S-125B06AR	●	○	6	63	137.55	40	2	3.1	6
	AHX640S-125B08AR	●	○	8	63	137.55	40	2	3.0	6
160	AHX640S-160C07NR	●	—	7	63	172.55	40	3	5.4	6
	AHX640S-160C10NR	●	—	10	63	172.55	40	3	5.2	6
200	AHX640S-200C08NR	●	—	8	63	212.55	60	4	7.8	6
	AHX640S-200C12NR	●	—	12	63	212.55	60	4	7.5	6

* WT : Tool Weight

SPARE PARTS

Tool Holder Number	*	
AHX640S	Clamp Screw CS5015060T	Wrench (Insert) TKY20T

* Clamp Torque (N · m) : CS5015060T=5.0

● : Inventory maintained.

MOUNTING DIMENSION > K046
SPARE PARTS > N001
TECHNICAL DATA > P001

K041

ROTATING TOOLS

INSERTS

ROTATING TOOLS

Work Material		P	Steel	●	✦														Cutting Conditions (Guide) : ● : Stable Cutting ● : General Cutting ✦ : Unstable Cutting Honing : E : Round						
		M	Stainless Steel			●																			
Application		Shape	Order Number	Class	Honing	Coated								Dimensions (mm)					Geometry						
						MP6120	MP6130	MP7030	MP9120	MP9130	MC5020	VP15TF	VP20RT	IC	RE	BS	S	APMX							
For Steel			NNMU200708ZEN-M	M	E	●	●												20	0.8	1	8	6		
General Cutting			NNMU200708ZEN-MP	M	E															20	0.8	1	8	6	
For Stainless Steel			NNMU200712ZER-MM	M	E		●												20	1.2	1	8	6		
General Cutting			NNMU200608ZEN-MK	M	E						●	★	★							20	0.8	1	6.55	6	
For Cast Iron			NNMU200608ZEN-HK	M	E						●	★	★						20	0.8	1	6.55	6		
Strong Cutting Edge Type			NNMU200712ZER-L	M	E			●	●											20	1.2	1	8	6	
For Titanium Alloy and Heat Resistant Alloy			WNEU2007ZEN7C-M	E	E	●													20	0.8	7.2	6.9	0.5		
Wiper			WNEU2007ZEN7C-WP	E	E															20	0.8	7.1	6.9	0.5	
General Cutting			WNEU2006ZEN7C-WK	E	E														20	0.8	7.4	6.55	0.5		
For Cast Iron			Wiper																						

Note 1) The height of cutter when setting MK, HK inserts is different from when setting MP, MM inserts.

● : Inventory maintained. ★ : Inventory maintained in Japan.
(10 inserts in one case)

INSTRUCTIONS FOR USE OF WIPER INSERTS

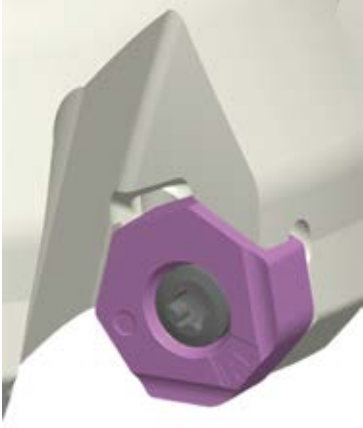

Fig.1



Fig.2

Note 1) These wiper inserts have 2 corners on right hand type and 2 corners for left hand type. Refer to Figure 1.

Note 2) A satisfactory finish surface can be achieved with one wiper insert. However, if the feed rate per revolution will be equal to or greater than the width of the wiper edge, it is recommended to install 2 or more wiper inserts spaced evenly within the cutting body.

ROTATING TOOLS

RECOMMENDED CUTTING CONDITIONS

■ Dry Cutting

Work Material	Hardness	Grade	Breaker	Vc (m/min)	fz (mm/t.)	ap (mm)	ae (mm)	
P Mild Steel	≤180HB	MP6120	M	250(200-300)	0.3(0.2-0.4)	≤5	≤0.8DC	
		VP15TF	MP	250(200-300)	0.3(0.2-0.4)	≤5	≤0.8DC	
		MP6130	M	220(170-270)	0.4(0.3-0.5)	≤5	≤0.8DC	
	Carbon Steel, Alloy Steel	180-280HB	MP6120	M	220(170-270)	0.3(0.2-0.4)	≤5	≤0.8DC
			VP15TF	MP	220(170-270)	0.3(0.2-0.4)	≤5	≤0.8DC
			MP6130	M	190(140-240)	0.4(0.3-0.5)	≤5	≤0.8DC
	Carbon Steel, Alloy Steel	280-350HB	MP6120	M	140(100-180)	0.3(0.2-0.4)	≤5	≤0.8DC
			VP15TF	MP	140(100-180)	0.3(0.2-0.4)	≤5	≤0.8DC
			MP6130	M	110(70-150)	0.4(0.3-0.5)	≤5	≤0.8DC
Pre-hardened Steel	≤350HB (Annealing)	MP6120	M	140(100-180)	0.15(0.1-0.2)	≤3	≤0.8DC	
		VP15TF	MP	140(100-180)	0.15(0.1-0.2)	≤3	≤0.8DC	
		MP6130	M	110(70-150)	0.25(0.2-0.3)	≤3	≤0.8DC	
Alloy Tool Steel	35-45HRC	MP6120	M	140(100-180)	0.15(0.1-0.2)	≤3	≤0.8DC	
		VP15TF	MP	140(100-180)	0.15(0.1-0.2)	≤5	≤0.8DC	
		MP6130	M	110(70-150)	0.25(0.2-0.3)	≤3	≤0.8DC	
M	Austenitic Stainless Steel	≤200HB	MP7030	MM	200(150-250)	0.2(0.1-0.3)	≤5	≤0.8DC
	Austenitic Stainless Steel	> 200HB	MP7030	MM	150(100-200)	0.2(0.1-0.3)	≤5	≤0.8DC
	Duplex Steel	≤280HB	MP7030	MM	140(100-180)	0.15(0.05-0.25)	≤5	≤0.8DC
	Ferritic and Martensitic Stainless Steel	≤200HB	MP7030	MM	200(150-250)	0.2(0.1-0.3)	≤5	≤0.8DC
	Ferritic and Martensitic Stainless Steel	> 200HB	MP7030	MM	150(100-200)	0.2(0.1-0.3)	≤5	≤0.8DC
	Precipitation Hardening Stainless Steel	< 450HB	MP7030	MM	130(100-160)	0.15(0.05-0.25)	≤5	≤0.8DC
K	Gray Cast Iron	Tensile Strength ≤350MPa	MC5020	MK, HK	220(150-300)	0.3(0.2-0.4)	≤5	≤0.8DC
			VP15TF, VP20RT	MK, HK	180(130-230)	0.3(0.2-0.4)	≤5	≤0.8DC
			VP15TF	MP	180(130-230)	0.3(0.2-0.4)	≤5	≤0.8DC
	Ductile Cast Iron	Tensile Strength ≤450MPa	MC5020	MK, HK	200(150-250)	0.2(0.1-0.3)	≤5	≤0.8DC
			VP15TF, VP20RT	MK, HK	170(120-220)	0.2(0.1-0.3)	≤5	≤0.8DC
	Ductile Cast Iron	Tensile Strength ≤800MPa	VP15TF	MP	170(120-220)	0.2(0.1-0.3)	≤5	≤0.8DC
MC5020			MK, HK	170(150-200)	0.2(0.1-0.3)	≤5	≤0.8DC	
VP15TF, VP20RT			MK, HK	140(100-180)	0.2(0.1-0.3)	≤5	≤0.8DC	
H	Hardened Steel	40-55HRC	VP15TF	MP	140(100-180)	0.2(0.1-0.3)	≤5	≤0.8DC
			VP15TF	MP	80(60-100)	0.15(0.1-0.2)	≤3	≤0.8DC

Note 1) Recommended wet cutting for good surface finishing of stainless steel. (Tool life is shorter when compared to dry cutting.)

Note 2) We recommend wet cutting with internal coolant for titanium alloy and heat resistant alloy.

Note 3) When clamp rigidity is low and tool overhang is long, we recommend to reduce the cutting speed and the feed rate by 30%.

Wet Cutting

	Work Material	Hardness	Breaker	Grade	Vc (m/min)	fz (mm/t.)	ap (mm)	ae (mm)
M	Austenitic Stainless Steel	≤200HB	MP7030	MM	125(100–150)	0.15(0.1–0.2)	≤5	≤0.8DC
	Austenitic Stainless Steel	> 200HB	MP7030	MM	100(75–125)	0.15(0.1–0.2)	≤5	≤0.8DC
	Duplex Steel	≤280HB	MP7030	MM	80(60–100)	0.1(0.05–0.15)	≤5	≤0.8DC
	Ferritic and Martensitic Stainless Steel	≤200HB	MP7030	MM	125(100–150)	0.15(0.1–0.2)	≤5	≤0.8DC
	Ferritic and Martensitic Stainless Steel	> 200HB	MP7030	MM	100(75–125)	0.15(0.1–0.2)	≤5	≤0.8DC
	Precipitation Hardening Stainless Steel	< 450HB	MP7030	MM	70(50–90)	0.1(0.05–0.15)	≤5	≤0.8DC
S	Titanium Alloy	—	MP7030	MM	40(20–50)	0.15(0.1–0.2)	≤3	≤0.6DC
		—	MP9120	L	60(50–70)	0.1(0.05–0.15)	≤3	≤0.6DC
		—	MP9130	L	40(20–50)	0.15(0.1–0.2)	≤3	≤0.6DC
	Heat Resistant Alloy	—	MP7030	MM	40(20–50)	0.15(0.1–0.2)	≤3	≤0.6DC
		—	MP9120	L	40(20–50)	0.15(0.1–0.2)	≤3	≤0.6DC
		—	MP9130	L	40(20–50)	0.15(0.1–0.2)	≤3	≤0.6DC

Note 1) Wet cutting for good surface finishes when machining stainless steel. (Tool life is shorter when compared to dry cutting.)

Note 2) We recommend wet cutting with internal coolant for titanium alloy and heat resistant alloy.

Note 3) When clamp rigidity is low and tool overhang is long, we recommend reducing the cutting speed and the feed rate by 30%.

Cutting Conditions with Wiper Insert

	Work Material	Hardness	Main Insert	Grade	Wiper Insert	Grade	Vc (m/min)	fz (mm/t.)	ap (mm)	ae (mm)
P	Mild Steel	≤180HB	VP15TF	MP	VP15TF	WP	250(200–300)	0.3(0.2–0.4)	≤0.5	≤0.8DC
			MP6120	M	MP6120	M	250(200–300)	0.3(0.2–0.4)	≤0.5	≤0.8DC
	Carbon Steel, Alloy Steel	180–280HB	VP15TF	MP	VP15TF	WP	220(170–270)	0.3(0.2–0.4)	≤0.5	≤0.8DC
			MP6120	M	MP6120	M	220(170–270)	0.3(0.2–0.4)	≤0.5	≤0.8DC
	Carbon Steel, Alloy Steel	280–350HB	VP15TF	MP	VP15TF	WP	140(100–180)	0.3(0.2–0.4)	≤0.5	≤0.8DC
			MP6120	M	MP6120	M	140(100–180)	0.3(0.2–0.4)	≤0.5	≤0.8DC
K	Gray Cast Iron	Tensile Strength ≤350MPa	MC5020	MK, HK	MC5020	WK	320(250–400)	0.3(0.2–0.4)	≤0.5	≤0.8DC
			VP15TF	MP	VP15TF	WP	220(150–300)	0.3(0.2–0.4)	≤0.5	≤0.8DC
	Ductile Cast Iron	Tensile Strength ≤450MPa	MC5020	MK, HK	MC5020	WK	250(200–300)	0.2(0.1–0.3)	≤0.5	≤0.8DC
			VP15TF	MP	VP15TF	WP	200(150–250)	0.2(0.1–0.3)	≤0.5	≤0.8DC
	Ductile Cast Iron	Tensile Strength ≤800MPa	MC5020	MK, HK	MC5020	WK	220(200–250)	0.2(0.1–0.3)	≤0.5	≤0.8DC
			VP15TF	MP	VP15TF	WP	170(150–200)	0.2(0.1–0.3)	≤0.5	≤0.8DC
S	Heat Resistant Alloy	—	VP15TF	MP	VP15TF	WP	40(20–50)	0.15(0.1–0.2)	≤0.5	≤0.8DC
H	Hardened Steel	40–55HRC	VP15TF	MP	VP15TF	WP	80(60–100)	0.15(0.1–0.2)	≤0.5	≤0.8DC

Note 1) When clamp rigidity is low and tool overhang is long, we recommend to reduce the cutting speed and the feed rate by 30%.

Note 2) Please use WP geometry insert in combination with MP or M geometry inserts, and use WK geometry insert in combination with MK or HK geometry inserts

AHX440S, AHX475S, AHX640S MOUNTING DIMENSIONS

Fig. 1

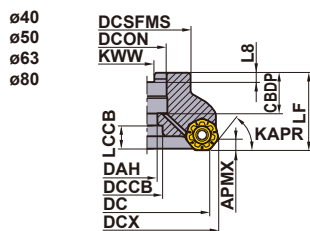

Fig. 2

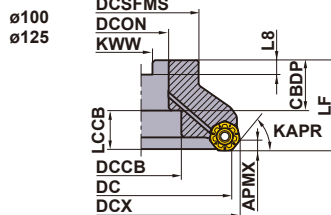
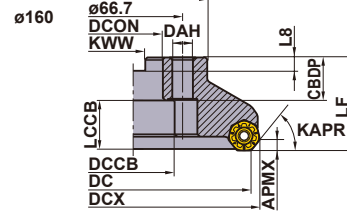

Fig. 3



Right hand tool holder only.

K

ROTATING TOOLS

DCON (mm)	DC (mm)	Order Number	Dimensions(mm)							Fig.
			CBDP	DAH	DCCB	LCCB	DCSFMS	KWW	L8	
16	40	AHX440S-040A03AR	18	9	14	13.9	37	8.4	5.6	1
16	40	AHX440S-040A04AR	18	9	14	13.9	37	8.4	5.6	1
22	50	AHX440S-050A04AR	20	11	17	11.9	47	10.4	6.3	1
22	50	AHX440S-050A05AR	20	11	17	11.9	47	10.4	6.3	1
22	50	AHX440S-050A06AR	20	11	17	11.9	47	10.4	6.3	1
22	50	AHX475S-050A04AR	20	11	17	16.7	47	10.4	6.3	5
22	50	AHX475S-050A05AR	20	11	17	16.7	47	10.4	6.3	5
22	63	AHX440S-063A05AR	20	11	17	11.9	50	10.4	6.3	1
22	63	AHX440S-063A06AR	20	11	17	11.9	50	10.4	6.3	1
22	63	AHX440S-063A08AR	20	11	17	11.9	50	10.4	6.3	1
22	63	AHX475S-063A05AR	20	11	17	16.7	60	10.4	6.3	5
22	63	AHX475S-063A06AR	20	11	17	16.7	60	10.4	6.3	5
22	63	AHX640S-063A04AR	20	11	17	16.2	50	10.4	6.3	1
22	63	AHX640S-063A05AR	20	11	17	16.2	50	10.4	6.3	1
27	80	AHX440S-080A06AR	23	13	20	14.9	56	12.4	7	1
27	80	AHX440S-080A08AR	23	13	20	14.9	56	12.4	7	1
27	80	AHX440S-080A10AR	23	13	20	14.9	56	12.4	7	1
27	80	AHX475S-080A06AR	23	13	20	14.7	76	12.4	7	5
27	80	AHX475S-080A08AR	23	13	20	14.7	76	12.4	7	5
27	80	AHX640S-080A04AR	23	13	20	15.2	56	12.4	7	1
27	80	AHX640S-080A06AR	23	13	20	15.2	56	12.4	7	1

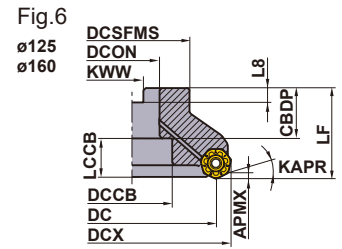
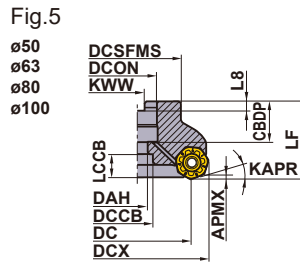
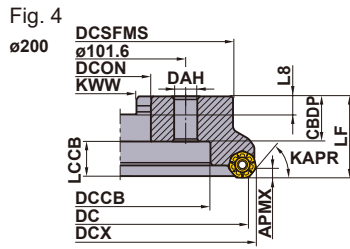

Right hand tool holder only.

DCON (mm)	DC (mm)	Order Number	Dimensions(mm)							Fig.
			CBDP	DAH	DCCB	LCCB	DCSFMS	KWW	L8	
32	100	AHX440S-100B07AR	32	—	45	16.9	78	14.4	8	2
32	100	AHX440S-100B10AR	32	—	45	16.9	78	14.4	8	2
32	100	AHX440S-100B12AR	32	—	45	16.9	78	14.4	8	2
32	100	AHX475S-100A07AR	26	17	26	25.7	96	14.4	8	5
32	100	AHX475S-100A09AR	26	17	26	25.7	96	14.4	8	5
32	100	AHX640S-100B05AR	32	—	45	16.2	78	14.4	8	2
32	100	AHX640S-100B07AR	32	—	45	16.2	78	14.4	8	2
40	125	AHX440S-125B08AR	40	—	56	21.9	89	16.4	9	2
40	125	AHX440S-125B12AR	40	—	56	21.9	89	16.4	9	2
40	125	AHX440S-125B14AR	40	—	56	21.9	89	16.4	9	2
40	125	AHX475S-125B08AR	40	—	56	21.7	100	16.4	9	6
40	125	AHX475S-125B10AR	40	—	56	21.7	100	16.4	9	6
40	125	AHX640S-125B06AR	42	—	56	19.2	89	16.4	9	2
40	125	AHX640S-125B08AR	42	—	56	19.2	89	16.4	9	2
40	160	AHX440S-160C10NR	40	14	56	21.9	100	16.4	9	3
40	160	AHX440S-160C14NR	40	14	56	21.9	100	16.4	9	3
40	160	AHX440S-160C16NR	40	14	56	21.9	100	16.4	9	3
40	160	AHX475S-160B10AR	40	—	56	21.7	100	16.4	9	6
40	160	AHX475S-160B12AR	40	—	56	21.7	100	16.4	9	6
40	160	AHX640S-160C07NR	29	14	56	32.2	120	16.4	9	3
40	160	AHX640S-160C10NR	29	14	56	32.2	120	16.4	9	3
60	200	AHX640S-200C08NR	32	18	140	29.2	175	25.7	14.22	4
60	200	AHX640S-200C12NR	32	18	140	29.2	175	25.7	14.22	4

ROTATING TOOLS

FACE MILLING

<HIGH FEED CUTTING FOR CAST IRON>

AHX640W



P M **K** N S H

K

ROTATING TOOLS



Fig.1
ø80

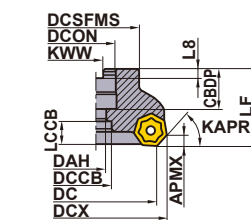

Fig.2
ø100
ø125

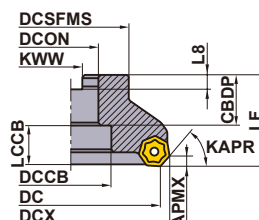

Fig.3
ø160

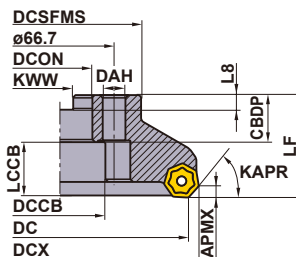

Fig.4
ø200
ø250

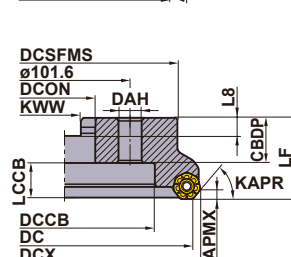
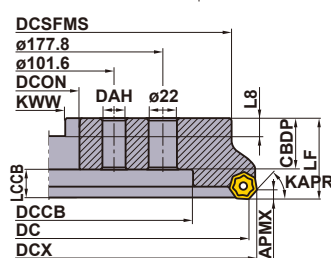

Fig.5
ø315



Right hand tool holder shown.

KAPR : 50°
GAMP: -6° GAMF: -4°

RIGHT HAND TOOL HOLDER

DC (mm)	Order Number	Stock	Coolant Hole	Number of Teeth	Dimensions (mm)			Fig.	WT* (kg)	APMX (mm)
					LF	DCX	DCON			
80	AHX640W-080A08R	●	—	8	50	92.6	27	1	1.5	6
	AHX640W-080A10R	●	—	10	50	92.6	27	1	1.5	6
100	AHX640W-100B10R	●	—	10	50	112.6	32	2	2.1	6
	AHX640W-100B14R	●	—	14	50	112.6	32	2	2.1	6
125	AHX640W-125B12R	●	—	12	63	137.6	40	2	3.1	6
	AHX640W-125B18R	●	—	18	63	137.6	40	2	3.1	6
160	AHX640W-160C16R	●	—	16	63	172.6	40	3	5.6	6
	AHX640W-160C22R	●	—	22	63	172.6	40	3	5.6	6
200	AHX640W-200C20R	●	—	20	63	212.6	60	4	8	6
	AHX640W-200C28R	●	—	28	63	212.6	60	4	8	6
250	AHX640W-250C24R	●	—	24	63	262.6	60	4	12.6	6
	AHX640W-250C36R	●	—	36	63	262.6	60	4	12.6	6
315	AHX640W-315C28R	●	—	28	80	327.6	60	5	31.5	6
	AHX640W-315C44R	●	—	44	80	327.6	60	5	31.5	6

* WT : Tool Weight





LEFT HAND TOOL HOLDER

DC (mm)	Order Number	Stock	Coolant Hole	Number of Teeth	Dimensions (mm)			Fig.	WT (kg)	APMX (mm)
					LF	DCX	DCON			
80	AHX640W-080A08L	★	—	8	50	92.6	27	1	1.5	6
	AHX640W-080A10L	★	—	10	50	92.6	27	1	1.5	6
100	AHX640W-100B10L	★	—	10	50	112.6	32	2	2.1	6
	AHX640W-100B14L	★	—	14	50	112.6	32	2	2.1	6
125	AHX640W-125B12L	★	—	12	63	137.6	40	2	3.1	6
	AHX640W-125B18L	★	—	18	63	137.6	40	2	3.1	6
160	AHX640W-160C16L	★	—	16	63	172.6	40	3	5.6	6
	AHX640W-160C22L	★	—	22	63	172.6	40	3	5.6	6
200	AHX640W-200C20L	★	—	20	63	212.6	60	4	8.0	6
	AHX640W-200C28L	★	—	28	63	212.6	60	4	8.0	6
250	AHX640W-250C24L	★	—	24	63	262.6	60	4	12.6	6
	AHX640W-250C36L	★	—	36	63	262.6	60	4	12.6	6
315	AHX640W-315C28L	★	—	28	80	327.6	60	5	31.5	6
	AHX640W-315C44L	★	—	44	80	327.6	60	5	31.5	6

● : Inventory maintained. ★ : Inventory maintained in Japan.

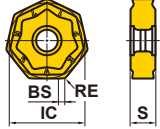
(10 inserts in one case)

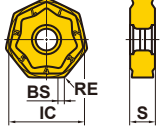

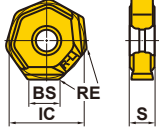
INSERTS

Work Material	K	Cast Iron	●	●	✦	Cutting Conditions (Guide) : ● : Stable Cutting ● : General Cutting ✦ : Unstable Cutting Honing : E : Round					Geometry	
Shape	Order Number	Class	Honing	Coated			Dimensions(mm)					Geometry
				MC5020	VP15TF	VP20RT	IC	RE	BS	S	APMX	
 General Cutting	NNMU200608ZEN-MK	M	E	●	★	★	20	0.8	1.0	6.55	6	
 Strong Cutting Edge Type	NNMU200608ZEN-HK	M	E	●	★	★	20	0.8	1.0	6.55	6	
 Wiper	WNEU2006ZEN7C-WK	E	E	●			20	0.8	7.4	6.55	0.5	

K
ROTATING TOOLS

SPARE PARTS



Tool Holder Number		 *	
	Wedge	Clamp Screw	Wrench
AHX640W	CWAHX640WN	LS0622T	TKY15T

* Clamp Torque (N • m) : LS0622T=6.0

RECOMMENDED CUTTING CONDITIONS

■ Dry-Wet Cutting

Work Material	Tensile Strength	Grade	Vc (m/min)	fz (mm/t.)
K Gray Cast Iron	≤350MPa	MC5020	220 (150-300)	0.3 (0.2-0.4)
		VP15TF VP20RT	180 (130-250)	0.3 (0.2-0.4)
Ductile Cast Iron	≤450MPa	MC5020	200 (150-250)	0.2 (0.1-0.3)
		VP15TF VP20RT	170 (120-220)	0.2 (0.1-0.3)
	≤800MPa	MC5020	170 (150-200)	0.2 (0.1-0.3)
		VP15TF VP20RT	140 (100-180)	0.2 (0.1-0.3)

* Please use 2-3 pcs of Wiper inserts in case of 'over 6mm/rev'.

■ Finishing (When using wiper insert)

Work Material	Grade	ap (mm)	Vc (m/min)	fz (mm/t.)
K Gray Cast Iron	MC5020	<0.5	320 (250-400)	0.2 (0.1-0.3)
		0.5-3	270 (200-350)	
Ductile Cast Iron		<0.5	270 (200-350)	
		0.5-3	220 (200-250)	

Note 1) With reference to the above examples, adjust the cutting conditions according to the use environment.

Note 2) Tool life when wet cutting is short compared to dry cutting.

MOUNTING DIMENSION > K050
SPARE PARTS > N001
TECHNICAL DATA > P001

K049

AHX640W MOUNTING DIMENSIONS

Fig.1
ø80

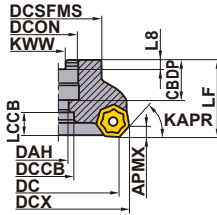

Fig.2
ø100
ø125

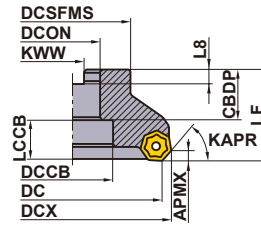

Fig.3
ø160

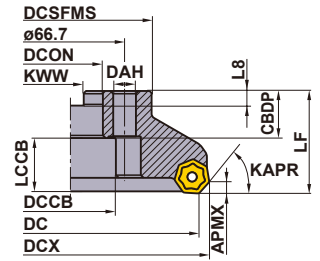

Fig.4
ø200
ø250

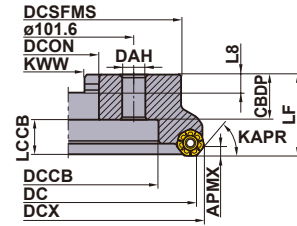
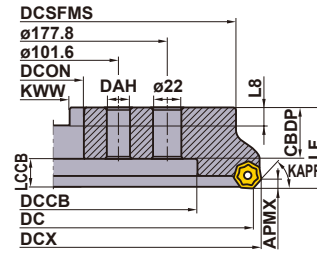

Fig.5
ø315



Right hand tool holder shown.

DCON (mm)	DC (mm)	Order Number	Dimensions(mm)							Fig.
			CBDP	DAH	DCCB	LCCB	DCSFMS	KWW	L8	
27	80	AHX640W-080A08L	23	13	20	14.8	56	12.4	7	1
27	80	AHX640W-080A08R	23	13	20	14.8	56	12.4	7	1
27	80	AHX640W-080A10L	23	13	20	14.8	56	12.4	7	1
27	80	AHX640W-080A10R	23	13	20	14.8	56	12.4	7	1
32	100	AHX640W-100B10L	32	—	45	16.8	70	14.4	8	2
32	100	AHX640W-100B10R	32	—	45	16.8	70	14.4	8	2
32	100	AHX640W-100B14L	32	—	45	16.8	70	14.4	8	2
32	100	AHX640W-100B14R	32	—	45	16.8	70	14.4	8	2
40	125	AHX640W-125B12L	32	—	56	29.8	80	16.4	9	2
40	125	AHX640W-125B12R	32	—	56	29.8	80	16.4	9	2
40	125	AHX640W-125B18L	32	—	56	29.8	80	16.4	9	2
40	125	AHX640W-125B18R	32	—	56	29.8	80	16.4	9	2
40	160	AHX640W-160C16L	29	14	56	32.8	100	16.4	9	3
40	160	AHX640W-160C16R	29	14	56	32.8	100	16.4	9	3
40	160	AHX640W-160C22L	29	14	56	32.8	100	16.4	9	3
40	160	AHX640W-160C22R	29	14	56	32.8	100	16.4	9	3
60	200	AHX640W-200C20L	32	18	135	29.8	155	25.7	14.22	4
60	200	AHX640W-200C20R	32	18	135	29.8	155	25.7	14.22	4
60	200	AHX640W-200C28L	32	18	135	29.8	155	25.7	14.22	4
60	200	AHX640W-200C28R	32	18	135	29.8	155	25.7	14.22	4
60	250	AHX640W-250C24L	32	18	180	29.8	200	25.7	14.22	4
60	250	AHX640W-250C24R	32	18	180	29.8	200	25.7	14.22	4
60	250	AHX640W-250C36L	32	18	180	29.8	200	25.7	14.22	4
60	250	AHX640W-250C36R	32	18	180	29.8	200	25.7	14.22	4
60	315	AHX640W-315C28L	57	18	225	21.8	285	25.7	14.22	5
60	315	AHX640W-315C28R	57	18	225	21.8	285	25.7	14.22	5
60	315	AHX640W-315C44L	57	18	225	21.8	285	25.7	14.22	5
60	315	AHX640W-315C44R	57	18	225	21.8	285	25.7	14.22	5

FACE MILLING

<HIGH FEED FINISHING>



FMAX

P M **K** N S H

For Compact and Smaller Machining Center



Fig.1
ø100
ø125

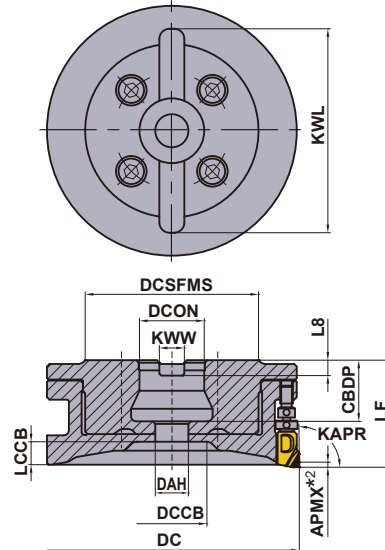

Right hand tool holder only.

ARBOR TYPE

KAPR: 90°
GAMP: PCD Grade +5° CBN Grade 0° GAMF: 0°

DC (mm)	Order Number	Stock	Coolant Hole	Number of Teeth	Dimensions (mm)		WT *1 (kg)	RPMX (min-1)	Fig.
					LF	DCON			
100	NEW FMAXR10010CLW	★	○	10	42	25.4	1.06	22000	1
100	NEW FMAXR10016CLW	★	○	16	42	25.4	1.11	22000	1
125	NEW FMAXR12514CLW	★	○	14	42	25.4	1.44	19600	1
125	NEW FMAXR12520CLW	★	○	20	42	25.4	1.48	19600	1

*1 WT : Tool Weight

*2 For the maximum depth of cut (APMX), please refer to recommended cutting conditions (ap).

Note 1) The maximum depth of cut should be 2mm or less for ultra high efficiency machining with table feed (Vf ≥ 20000mm/min).

Note 2) Rake angle axial GAMP varies depending on the insert grade.

MOUNTING DIMENSIONS

DCON (mm)	DC (mm)	Order Number	Dimensions (mm)								Fig.
			CBDB	DAH	DCCB	LCCB	DCSFMS	KWW	L8	KWL	
25.4	100	FMAXR10010CLW	24	13	27	9	68	9.5	6	80	1
25.4	100	FMAXR10016CLW	24	13	27	9	68	9.5	6	80	1
25.4	125	FMAXR12514CLW	24	13	52	9	68	9.5	6	80	1
25.4	125	FMAXR12520CLW	24	13	52	9	68	9.5	6	80	1

SPARE PARTS

Insert Clamp Screw *	Micro Adjustment Nut	Large Adjustment Screw	Cutter Set Bolt	Wrench T10	Wrench ø2.5
TSS04505S	KSN3	KSS2	HSCX12030H	TKY10T	RKY25S

* Clamp Torque (N • m) : TSS04505S=3.5

Note 1) Please refer to the instruction manual included with the cutter body for how to locate the insert and adjust the run out and the balance.

★ : Inventory maintained in Japan.

SPARE PARTS > N001
TECHNICAL DATA > P001

K051

K

ROTATING TOOLS

FMAX - 40/50/63

Fig.1

ø40
ø50
ø63

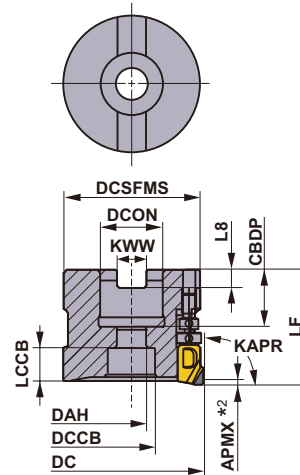

K

ROTATING TOOLS

ARBOR TYPE

KAPR: 90°

GAMP: PCD Grade +5° CBN Grade 0° GAMF: -6°— -3°

Right hand tool holder only.

DC (mm)	Order Number	Stock	Coolant Hole	Number of Teeth	Dimensions (mm)		WT *1 (kg)	RPMX (min-1)	Fig.
					LF	DCON			
40	FMAX-040A04R	★	○	4	40	16	0.24	30000	1
40	FMAX-040A06R	★	○	6	40	16	0.23	30000	1
50	FMAX-050A08R	★	○	8	40	22	0.37	30000	1
50	FMAX-050A10R	●	○	10	40	22	0.35	30000	1
63	FMAX-063A10R	★	○	10	40	22	0.67	27000	1
63	FMAX-063A12R	●	○	12	40	22	0.66	27000	1

*1 WT : Tool Weight

*2 For the maximum depth of cut (APMX), please refer to recommended cutting conditions (ap).

Note 1) The maximum depth of cut for should be 2mm or less for ultra high efficiency machining with table feed (Vf ≥ 20000mm/min).

Note 2) Rake angle axial GAMP varies depending on the insert grade.

MOUNTING DIMENSIONS

DCON (mm)	DC (mm)	Order Number	Dimensions (mm)								Fig.
			CBDP	DAH	DCCB	LCCB	DCSFMS	KWW	L8	KWL	
16	40	FMAX-040A04R	18	9	14	10	37	8.4	5.6	—	1
16	40	FMAX-040A06R	18	9	14	10	37	8.4	5.6	—	1
22	50	FMAX-050A08R	20	11	17	12	47	10.4	6.3	—	1
22	50	FMAX-050A10R	20	11	17	12	47	10.4	6.3	—	1
22	63	FMAX-063A10R	20	11	17	12	60	10.4	6.3	—	1
22	63	FMAX-063A12R	20	11	17	12	60	10.4	6.3	—	1

SPARE PARTS

DC	Tool Holder Type	Insert Clamp Screw *	Micro Adjustment Nut	Large Adjustment Screw	Cutter Set Bolt	Wrench T10	Wrench ø2.5
40	FMAX-040	TSS04505S	KSN3	KSS2	HSC08030H	TKY10T	RKY25S
50	FMAX-050	TSS04505S	KSN3	KSS2	HSC10030H	TKY10T	RKY25S
63	FMAX-063	TSS04505S	KSN3	KSS2	HSC10030H	TKY10T	RKY25S

* Clamp Torque (N · m) : TSS04505S=3.5

Note 1) Please refer to the instruction manual included in the cutter body for how to locate the insert and adjust the run out and the balance.

● : Inventory maintained. ★ : Inventory maintained in Japan.

FMAX



Fig.1
ø80

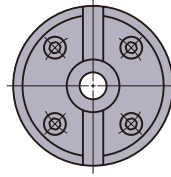
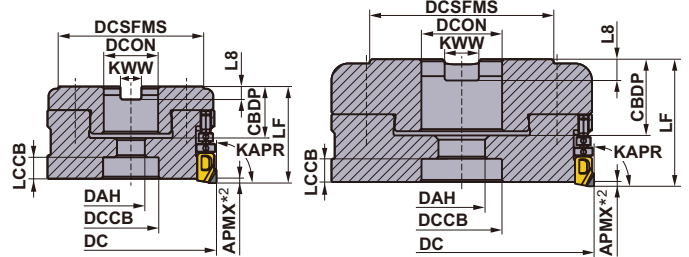
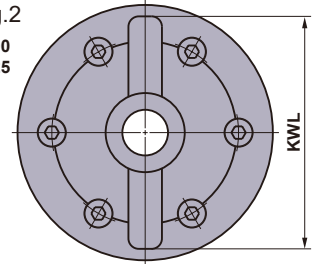

Fig.2
ø100
ø125



Right hand tool holder only.

ARBOR TYPE

KAPR: 90°

GAMP: PCD Grade +5° CBN Grade 0° GAMF: 0°

DC (mm)	Order Number	Stock	Coolant Hole	Number of Teeth	Dimensions (mm)		WT ^{*1} (kg)	RPMX (min-1)	Fig.
					LF	DCON			
80	FMAX-080B14R	●	○	14	45	27	1.08	24500	1
100	FMAX-100B18R	●	○	18	50	32	1.81	22000	2
125	FMAX-125B24R	●	○	24	60	40	3.26	19600	2

*1 WT : Tool Weight

*2 For the maximum depth of cut (**APMX**), please refer to recommended cutting conditions (**ap**).

Note 1) The maximum depth of cut for should be 2mm or less for ultra high efficiency machining with table feed (**Vf** ≥ 20000mm/min).

Note 2) Rake angle axial **GAMP** varies depending on the insert grade.

MOUNTING DIMENSIONS

DCON (mm)	DC (mm)	Order Number	Dimensions (mm)								Fig.
			CBDP	DAH	DCCB	LCCB	DCSFMS	KWW	L8	KWL	
27	80	FMAX-080B14R	24	13	26	11	68	12.4	7	—	1
32	100	FMAX-100B18R	32	17	32	10	79	14.4	8	90	2
40	125	FMAX-125B24R	36	22	38	12	88	16.4	9	112	2

SPARE PARTS







DC	Tool Holder Type	Insert Clamp Screw *	Micro Adjustment Nut	Large Adjustment Screw	Cutter Set Bolt	Wrench T10	Wrench ø2.5
80	FMAX-080	TSS04505S	KSN3	KSS2	HSCX12030H	TKY10T	RKY25S
100	FMAX-100	TSS04505S	KSN3	KSS2	HSCX16035H	TKY10T	RKY25S
125	FMAX-125	TSS04505S	KSN3	KSS2	HSCX20035H	TKY10T	RKY25S

* Clamp Torque (N · m) : TSS04505S=3.5

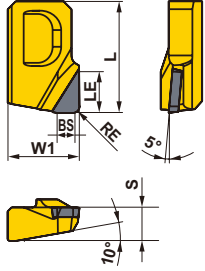
Note 1) Please refer to the instruction manual included with the cutter body for how to locate the insert and adjust the run out and the balance.

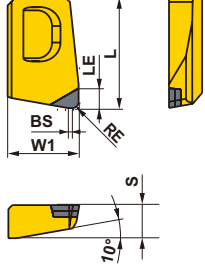
ROTATING TOOLS

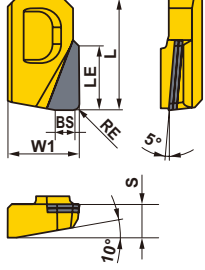
INSERTS

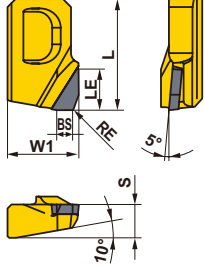
Work Material	K	Cast Iron				Cutting Conditions :					Geometry
	N	Non-ferrous Metal	●	●	●	●	●	●	●	●	
Shape	Order Number	MD220	MD2030	MB4120	Dimensions (mm)					Geometry	
		L	LE	W1	S	BS	RE				
For Aluminium Alloys 	GOER1404PXFR2	●	●		14.0	5.0	9.0	4.2	2.0	0.4	
	GOER1408PXFR2	●	●		14.0	5.0	9.0	4.2	2.0	0.8	
General Purpose											
For Gray Cast Irons 	NEW NP-GOEN1404PXSR05			★	14.0	2.5	9.0	4.2	0.5	0.4	
	NEW NP-GOEN1408PXSR05			★	14.0	2.5	9.0	4.2	0.5	0.8	
General Purpose											
For Aluminium Alloys 	NEW GOER1408PXFR2-8	★			14.0	8.0	9.0	4.2	2.0	0.8	
Long Edge											
For Aluminium Alloys 	GOER1401ZXFR2	●			14.0	5.0	9.0	4.2	2.0	0.1	
Burr Prevention											

For Aluminium Alloys: Sharp Edge

For Gray Cast Irons: Chamferd and Rounded (0.13mmx15°+R0.01)

● = NEW

Note 1) If general purpose inserts (RE = 0.4mm, 0.8mm), burr prevention inserts and long edge inserts are used together, they will not be able to sufficiently display their full performance. Inserts of the same shape should be used according to the application.

Note 2) The cutting diameter will change depending on the shape. Be particularly careful when cutting near vertical walls, since there is a possibility of interference with the holder.

● : Inventory maintained. ★ : Inventory maintained in Japan.
(CBN and PCD inserts are available in 1 piece in one case)

RECOMMENDED CUTTING CONDITIONS

Work Material	Properties	Grade	Vc (m/min)	ae (mm)	ap (mm)	fz (mm/t.)	Cutting Mode	
K	Gray Cast Irons	Tensile Strength ≤350MPa	MB4120	1000 (700–1300)	≤ 0.8 DC	≤ 0.5	0.07 (0.05–0.15)	Dry Cutting
N	Aluminium Alloys	Si < 5%	MD2030 MD220	2500 (2000–3000)	≤ 0.2 DC	≤ 3.0 (0.5–3.0)	0.08 (0.05–0.2)	Wet Cutting
					≤ 0.5 DC	≤ 2.5 (0.5–2.5)		
					≤ 0.8 DC	≤ 2.0 (0.5–2.0)		
		5% ≤ Si ≤ 10%	MD2030 MD220	2500 (2000–3000)	≤ 0.2 DC	≤ 3.0 (0.5–3.0)	0.08 (0.05–0.2)	Wet Cutting
					≤ 0.5 DC	≤ 2.5 (0.5–2.5)		
					≤ 0.8 DC	≤ 2.0 (0.5–2.0)		
		10% < Si < 15%	MD220 MD2030	600 (400–800)	≤ 0.2 DC	≤ 3.0 (0.5–3.0)	0.08 (0.05–0.2)	Wet Cutting
					≤ 0.5 DC	≤ 2.5 (0.5–2.5)		
					≤ 0.8 DC	≤ 2.0 (0.5–2.0)		
		Si ≥ 15%	MD220 MD2030	600 (400–800)	≤ 0.2 DC	≤ 3.0 (0.5–3.0)	0.08 (0.05–0.2)	Wet Cutting
					≤ 0.5 DC	≤ 2.5 (0.5–2.5)		
					≤ 0.8 DC	≤ 2.0 (0.5–2.0)		

Note 1) Please adjust the depth of cut depending on the width of cut.

Note 2) When using the long edge insert, please select the conditions depending on depths of cut (ap) excluding the length of the gate.

K

ROTATING TOOLS

ROTATING TOOLS

SHOULDER MILLING

<GENERAL CUTTING>



WWX400

NEW

P M K N S H

ROTATING TOOLS

K



Fig.1
ø50

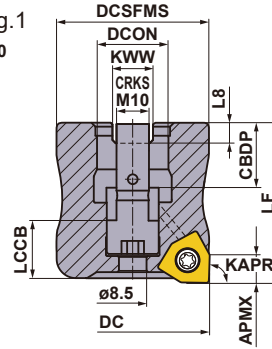
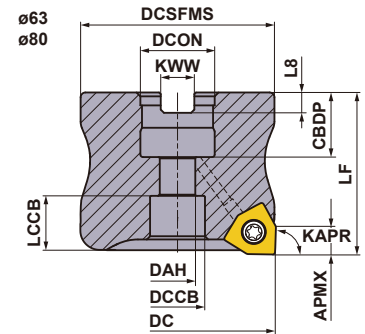

Fig.2



Right hand tool holder only.

ARBOR TYPE

KAPR : 90°

GAMP : -6° GAMF : -7.2° ~ -12.8°

DC (mm)	Order Number	Stock	Coolant Hole	Number of Teeth	Dimensions (mm)		APMX (mm)	WT* (kg)	RMPX	RPMX (min ⁻¹)	Fig.
		R			LF	DCON					
50	WWX400-050A03AR	★	○	3	55	22	8.2	0.5	0.4°	5000	1
50	WWX400-050A04AR	●	○	4	55	22	8.2	0.5	0.4°	5000	1
63	WWX400-063A03AR	★	○	3	40	22	8.2	0.5	0.26°	14100	2
63	WWX400-063A04AR	●	○	4	40	22	8.2	0.5	0.26°	14100	2
63	WWX400-063A05AR	●	○	5	40	22	8.2	0.5	0.26°	14100	2
80	WWX400-080A04AR	★	○	4	50	27	8.2	1.0	0.16°	12200	2
80	WWX400-080A05AR	●	○	5	50	27	8.2	1.0	0.16°	12200	2
80	WWX400-080A07AR	●	○	7	50	27	8.2	0.9	0.16°	12200	2
100	WWX400-100B05AR	★	○	5	50	32	8.2	1.6	—	10700	3
100	WWX400-100B07AR	●	○	7	50	32	8.2	1.5	—	10700	3
100	WWX400-100B09AR	●	○	9	50	32	8.2	1.5	—	10700	3
125	WWX400-125B06AR	★	○	6	63	40	8.2	3.0	—	9500	3
125	WWX400-125B08AR	●	○	8	63	40	8.2	3.0	—	9500	3
125	WWX400-125B12AR	★	○	12	63	40	8.2	2.9	—	9500	3
160	WWX400-160C08NR	★	—	8	63	40	8.2	4.5	—	8300	4
160	WWX400-160C10NR	★	—	10	63	40	8.2	4.4	—	8300	4
160	WWX400-160C14NR	★	—	14	63	40	8.2	4.4	—	8300	4
200	WWX400-200C10NR	★	—	10	63	60	8.2	6.7	—	7300	5
200	WWX400-200C12NR	★	—	12	63	60	8.2	6.7	—	7300	5
200	WWX400-200C16NR	★	—	16	63	60	8.2	6.6	—	7300	5
250	WWX400-250C12NR	★	—	12	63	60	8.2	11.5	—	6400	5
250	WWX400-250C14NR	★	—	14	63	60	8.2	11.5	—	6400	5
250	WWX400-250C18NR	★	—	18	63	60	8.2	11.4	—	6400	5

Note 1) A set bolt to the arbor is not supplied with the body. Please refer to page K057, when ordering.

Note 2) The milling cutter with cutting diameter DC=50 mm has a built-in set bolt. The set bolt cannot be replaced. Therefore, absolutely do not disassemble the milling cutter.

Note 3) Please use a set bolt of the FMC type on the cutter body from 63 to 100 in diameter (DC).

Note 4) Please use a set bolt of the FMA type on the cutter body from 125 to 250 in diameter (DC).

* WT : Tool Weight

SPARE PARTS

Tool Holder Type	*		
WWX400	TS5R	TKY20T	MK1KS

* Clamp Torque (N · m) : TS5R = 5.0

● : Inventory maintained. ★ : Inventory maintained in Japan.

Fig.3
ø100
ø125

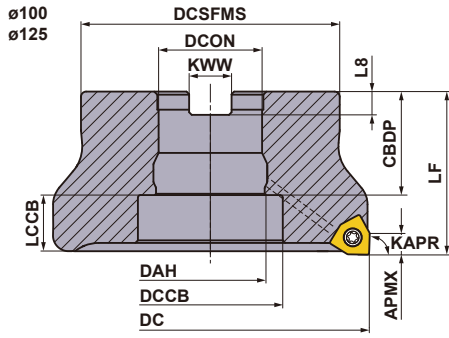
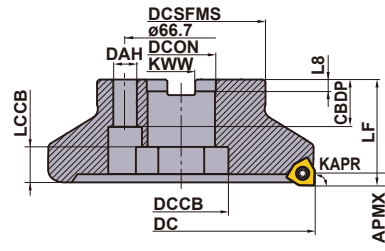
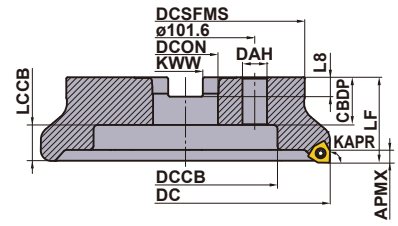

Fig.4
ø160



Right hand tool holder only.

Fig.5
ø200
ø250



MOUNTING DIMENSIONS

DC (mm)	Order Number	Dimensions (mm)								Fig.
		DCON	CBDP	DAH	DCCB	LCCB	DCSFMS	KWW	L8	
50	WWX400-050A03AR	22	20	—	—	12.2	47	10.4	6.3	1
50	WWX400-050A04AR	22	20	—	—	12.2	47	10.4	6.3	1
63	WWX400-063A03AR	22	20	11	17	11.2	50	10.4	6.3	2
63	WWX400-063A04AR	22	20	11	17	11.2	50	10.4	6.3	2
63	WWX400-063A05AR	22	20	11	17	11.2	50	10.4	6.3	2
80	WWX400-080A04AR	27	23	13	20	14.2	56	12.4	7	2
80	WWX400-080A05AR	27	23	13	20	14.2	56	12.4	7	2
80	WWX400-080A07AR	27	23	13	20	14.2	56	12.4	7	2
100	WWX400-100B05AR	32	32	32	45	16.2	78	14.4	8	3
100	WWX400-100B07AR	32	32	32	45	16.2	78	14.4	8	3
100	WWX400-100B09AR	32	32	32	45	16.2	78	14.4	8	3
125	WWX400-125B06AR	40	40	40	56	21.2	89	16.4	9	3
125	WWX400-125B08AR	40	40	40	56	21.2	89	16.4	9	3
125	WWX400-125B12AR	40	40	40	56	21.2	89	16.4	9	3
160	WWX400-160C08NR	40	40	14	56	21.2	100	16.4	9	4
160	WWX400-160C10NR	40	40	14	56	21.2	100	16.4	9	4
160	WWX400-160C14NR	40	40	14	56	21.2	100	16.4	9	4
200	WWX400-200C10NR	60	32	18	135	29.2	160	25.7	14.22	5
200	WWX400-200C12NR	60	32	18	135	29.2	160	25.7	14.22	5
200	WWX400-200C16NR	60	32	18	135	29.2	160	25.7	14.22	5
250	WWX400-250C12NR	60	32	18	180	29.2	210	25.7	14.22	5
250	WWX400-250C14NR	60	32	18	180	29.2	210	25.7	14.22	5
250	WWX400-250C18NR	60	32	18	180	29.2	210	25.7	14.22	5

SET BOLT (SOLD SEPARATELY)

Tool Holder Type	Set Bolt		Fig.	Reference Dimensions (mm)								Geometry
	With Coolant Hole	Without Coolant Hole		a	b	c	d	e	f	g		
	Order Number	Order Number										
WWX400-063A \odot AR	HSC10030H	HSC10035	1	16	M10×1.5	40	10	6	—	—		
WWX400-080A \odot AR	HSC12035H	HSC12035 HSC12045	1	18	M12×1.75	47 57	12	10	—	—		
WWX400-100B \odot AR	MBA16033H	—	2	40	M16×2	43	10	14	6	23		
WWX400-125B \odot AR	MBA20040H	—	2	50	M20×2.5	54	14	17	6	27		
WWX400-160C \odot NR	No Coolant Hole	—	2	50	M20×2.5	54	14	17	6	27		
WWX400-200C \odot NR	No Coolant Hole	—	1	24	M16×2	43	16	14	—	—		
WWX400-250C \odot NR	No Coolant Hole	—	1	24	M16×2	43	16	14	—	—		

Note 1) Internal coolant is necessary with the set bolt.

Note 2) The milling cutter with cutting diameter DC=50 mm has a built-in set bolt.

Please use a 7 mm Allen wrench to tighten/loosen the set bolt.

ROTATING TOOLS

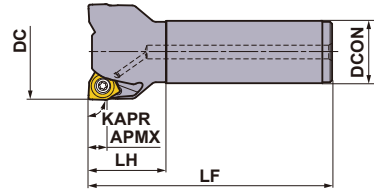

Right hand tool holder only.

K

ROTATING TOOLS



SHANK TYPE

With Coolant Hole

DC (mm)	Order Number	Stock	Number of Teeth	Dimensions (mm)			APMX (mm)	WT [*] (kg)	RMPX	RPMX (min ⁻¹)
		R		LF	DCON	LH				
50	WWX400R5003SA32M	★	3	125	32	40	8.2	0.8	0.4°	16000
50	WWX400R5004SA32M	★	4	125	32	40	8.2	0.8	0.4°	16000
63	WWX400R6303SA32M	★	3	125	32	40	8.2	1.0	0.26°	14100
63	WWX400R6304SA32M	★	4	125	32	40	8.2	1.0	0.26°	14100
63	WWX400R6305SA32M	★	5	125	32	40	8.2	1.0	0.26°	14100
80	WWX400R8004SA32M	★	4	125	32	40	8.2	1.3	0.16°	12200
80	WWX400R8005SA32M	★	5	125	32	40	8.2	1.3	0.16°	12200
80	WWX400R8007SA32M	★	7	125	32	40	8.2	1.2	0.16°	12200

* WT : Tool Weight

SPARE PARTS

Tool Holder Type			
	WWX400	TS5R	TKY20T

* Clamp Torque (N · m) : TS5R = 5.0

● : Inventory maintained. ★ : Inventory maintained in Japan.
(10 inserts in one case)

ROTATING TOOLS

RECOMMENDED CUTTING CONDITIONS

■ Dry Cutting Cutting Speed

(mm)

ROTATING TOOLS

K

Work Material	Properties	Cutting Conditions	Grade	ae			
				0.5DC≥	0.8DC≥	DC(Slot)	
				Vc (m/min)			
P	Mild Steel	Hardness ≤180HB	●	MP6120	240(200–280)	220(180–260)	200(160–240)
			●	MP6130	230(190–270)	210(170–250)	190(150–230)
			✱	MP6130,VP15TF	210(170–250)	190(150–230)	170(130–210)
	Carbon Steel Alloy Steel	Hardness 180–280HB	●	MP6120	210(170–250)	190(150–230)	170(130–210)
			●	MP6130	200(160–240)	180(140–220)	160(120–200)
			✱	MP6130,VP15TF	180(140–220)	160(120–200)	140(100–180)
	Carbon Steel Alloy Steel Alloy Tool Steel	Hardness 280–350HB ≤350HB (Annealing)	●	MP6120	200(160–240)	180(140–220)	160(120–200)
			●	MP6130	190(150–230)	170(130–210)	150(110–190)
			✱	MP6130,VP15TF	170(130–210)	150(110–190)	130(90–170)
	Pre-hardened Steel	Hardness 35–45HRC	●	MP6120	140(120–160)	–	–
			●	MP6130	120(100–140)	–	–
			✱	MP6130,VP15TF	110(90–130)	–	–
M	Austenitic Stainless Steel	Hardness ≤200HB	●	MP7130	180(160–200)	160(140–180)	–
			●	MP7130,VP15TF	170(150–190)	150(130–170)	–
			✱	MP7130,VP15TF	150(130–170)	130(110–150)	–
	Austenitic Stainless Steel	Hardness >200HB	●	MP7130	170(150–190)	150(130–170)	–
			●	MP7130,VP15TF	160(140–180)	140(120–160)	–
			✱	MP7130,VP15TF	140(120–160)	120(100–140)	–
	Ferritic and Martensitic Stainless Steel	Hardness ≤200HB	●	MP7130	180(160–200)	160(140–180)	–
			●	MP7130,VP15TF	170(150–190)	150(130–170)	–
			✱	MP7130,VP15TF	150(130–170)	130(110–150)	–
	Duplex Stainless Steel	Hardness ≤280HB	●	MP7130	160(140–180)	140(120–160)	–
			●	MP7130,VP15TF	150(130–170)	130(110–150)	–
			✱	MP7130,VP15TF	130(110–150)	110(90–130)	–
Precipitation Hardening Stainless Steel	Hardness <450HB	●	MP7130	140(120–160)	–	–	
		●	MP7130,VP15TF	130(110–150)	–	–	
		✱	MP7130,VP15TF	110(90–130)	–	–	
K	Gray Cast Iron	Tensile Strength ≤350MPa	●	MC5020	250(210–290)	230(190–270)	210(170–250)
			●	MC5020	240(200–280)	220(180–260)	200(160–240)
			●	VP15TF	240(200–280)	220(180–260)	–
			✱	MC5020,VP15TF	220(180–260)	200(160–240)	180(140–220)
	Ductile Cast Iron	Tensile Strength ≤450MPa	●	MC5020	220(180–160)	200(160–240)	180(140–220)
			●	MC5020	210(170–250)	190(150–230)	170(130–210)
			●	VP15TF	210(170–250)	190(150–230)	–
	Ductile Cast Iron	Tensile Strength ≤800MPa	✱	MC5020,VP15TF	190(150–230)	170(130–210)	150(110–190)
			●	MC5020	180(140–220)	160(120–200)	140(100–180)
			●	MC5020	170(130–210)	150(110–190)	130(90–170)
	Ductile Cast Iron	Tensile Strength ≤800MPa	●	VP15TF	170(130–210)	150(110–190)	–
			●	MC5020,VP15TF	150(110–190)	130(90–170)	110(70–150)
✱			MC5020,VP15TF	150(110–190)	130(90–170)	–	
H	Hardened Steel	Hardness 40–55HRC	●	VP15TF	50(30–70)	–	–
			●	VP15TF	50(30–70)	–	–

Note 1) The recommended cutting speed has been calculated for a depth of cut of 2mm. Please reduce the cutting speed by an appropriate amount corresponding to the increase in cutting depth.

Cutting Conditions (Guide) :

● : Stable Cutting ● : General Cutting ✖ : Unstable Cutting

**Wet Cutting
Cutting Speed**

(mm)

Work Material	Properties	Cutting Conditions	Grade	ae			
				0.5DC≥	0.8DC≥	DC(Slot)	
				Vc (m/min)			
P	Mild Steel	Hardness ≤180HB	●	MP6120	150(140–160)	130(120–140)	120(110–130)
			●	MP6130	140(130–150)	120(110–130)	110(100–120)
			✖	MP6130,VP15TF	120(110–130)	100(90–110)	90(80–100)
	Carbon Steel Alloy Steel	Hardness 180–280HB	●	MP6120	150(140–160)	130(120–140)	120(110–130)
			●	MP6130	140(130–150)	120(110–130)	110(100–120)
			✖	MP6130,VP15TF	120(110–130)	100(90–110)	90(80–100)
	Carbon Steel Alloy Steel Alloy Tool Steel	Hardness 280–350HB (Annealing)	●	MP6120	140(130–150)	120(110–130)	110(100–120)
			●	MP6130	130(120–140)	110(100–120)	100(90–110)
			✖	MP6130,VP15TF	110(100–120)	90(80–100)	80(70–90)
	Pre-hardened Steel	Hardness 35–45HRC	●	MP6120	110(100–120)	–	–
			●	MP6130	100(90–110)	–	–
			✖	MP6130,VP15TF	80(70–90)	–	–
M	Austenitic Stainless Steel	Hardness ≤200HB	●	MP7130	130(120–140)	110(100–120)	–
			●	MP7130,VP15TF	120(110–130)	100(90–110)	–
			✖	MP7130,VP15TF	100(90–110)	80(70–90)	–
	Austenitic Stainless Steel	Hardness >200HB	●	MP7130	130(120–140)	110(100–120)	–
			●	MP7130,VP15TF	120(110–130)	100(90–110)	–
			✖	MP7130,VP15TF	100(90–110)	80(70–90)	–
	Ferritic and Martensitic Stainless Steel	Hardness ≤200HB	●	MP7130	130(120–140)	110(100–120)	–
			●	MP7130,VP15TF	120(110–130)	100(90–110)	–
			✖	MP7130,VP15TF	100(90–110)	80(70–90)	–
	Duplex Stainless Steel	Hardness ≤280HB	●	MP7130	120(110–130)	100(90–110)	–
			●	MP7130,VP15TF	110(100–120)	90(80–100)	–
			✖	MP7130,VP15TF	90(80–100)	70(60–80)	–
Precipitation Hardening Stainless Steel	Hardness <450HB	●	MP7130	120(110–130)	–	–	
		●	MP7130,VP15TF	110(100–120)	–	–	
		✖	MP7130,VP15TF	90(80–100)	–	–	
K	Gray Cast Iron	Tensile Strength ≤350MPa	●	MC5020	170(150–190)	150(130–170)	130(110–150)
			●	MC5020	160(140–180)	140(120–160)	120(100–140)
			●	VP15TF	160(140–180)	140(120–160)	–
			✖	MC5020,VP15TF	140(120–160)	120(100–140)	100(80–120)
	Ductile Cast Iron	Tensile Strength ≤450MPa	●	MC5020	170(150–190)	150(130–170)	130(110–150)
			●	MC5020	160(140–180)	140(120–160)	120(100–140)
			✖	MC5020,VP15TF	140(120–160)	120(100–140)	100(80–120)
	Ductile Cast Iron	Tensile Strength ≤800MPa	●	MC5020	160(150–170)	140(130–150)	120(110–130)
			●	MC5020	150(140–160)	130(120–140)	110(100–120)
			✖	MC5020,VP15TF	130(120–140)	110(100–120)	90(80–100)
	Aluminium Alloy	Si<5%	●	TF15	500(300–900)	500(300–900)	500(300–900)
			●	TF15	500(300–900)	500(300–900)	500(300–900)
✖			TF15	400(200–800)	400(200–800)	400(200–800)	
S	Titanium Alloy	–	●	MP9120	80(60–100)	–	–
			●	MP9120	70(50–90)	–	–
			✖	MP9130	60(40–80)	–	–
	Heat Resistant Alloy	–	●	MP9120	60(50–70)	–	–
			●	MP9120	50(30–60)	–	–
			✖	MP9130	40(20–40)	–	–
H	Hardened Steel	Hardness 40–55HRC	●	VP15TF	50(30–70)	–	–
			●	VP15TF	50(30–70)	–	–

Note 1) Refer to the above table for cutting conditions according to the applications.

K

ROTATING TOOLS

RECOMMENDED CUTTING CONDITIONS

Depth of Cut / Feed per Tooth

Work Material	Properties	Cutting Conditions	Grade	ae			
				0.5DC ≥			
				Breaker	ap	fz (mm/t.)	
P Mild Steel	Hardness ≤180HB	●	MP6120	L,M	≤4.0	0.13(0.10—0.15)	
		● ●	MP6130	L,M	≤4.0	0.13(0.10—0.15)	
		● ●		M,R	≤4.0	0.16(0.10—0.20)	
		● ✚	MP6130,VP15TF	M,R	≤4.0	0.13(0.10—0.15)	
	Carbon Steel Alloy Steel	Hardness 180—280HB	●	MP6120	L,M	≤4.0	0.13(0.10—0.15)
			● ●	MP6130	L,M	≤4.0	0.13(0.10—0.15)
			● ●		M,R	≤4.0	0.16(0.10—0.20)
			● ✚	MP6130,VP15TF	M,R	≤4.0	0.13(0.10—0.15)
	Carbon Steel Alloy Steel Alloy Tool Steel	Hardness 280—350HB ≤350HB (Annealing)	●	MP6120	L,M	≤3.0	0.13(0.10—0.15)
			● ●	MP6130	L,M	≤3.0	0.13(0.10—0.15)
			● ●		M,R	≤3.0	0.16(0.10—0.20)
			● ✚	MP6130,VP15TF	M,R	≤3.0	0.13(0.10—0.15)
Pre-hardened Steel	Hardness 35—45HRC	●	MP6120	L,M	≤2.0	0.13(0.10—0.15)	
		● ●	MP6130	L,M	≤2.0	0.13(0.10—0.15)	
		● ●		M,R	≤2.0	0.16(0.10—0.20)	
		● ✚	MP6130,VP15TF	M,R	≤2.0	0.13(0.10—0.15)	
M	Austenitic Stainless Steel	Hardness ≤200HB	● ●	MP7130	L,M	≤4.0	0.13(0.10—0.15)
			● ●	VP15TF	M	≤4.0	0.16(0.10—0.20)
			● ✚	MP7130,VP15TF	M	≤4.0	0.13(0.10—0.15)
	Austenitic Stainless Steel	Hardness >200HB	●	MP7130	L,M	≤4.0	0.13(0.10—0.15)
			● ●	MP7130	L,M	≤3.0	0.13(0.10—0.15)
			● ●	VP15TF	M	≤3.0	0.16(0.10—0.20)
			● ✚	MP7130,VP15TF	M	≤3.0	0.13(0.10—0.15)
	Ferritic and Martensitic Stainless Steel	Hardness ≤200HB	● ●	MP7130	L,M	≤4.0	0.13(0.10—0.15)
			● ●	VP15TF	M	≤4.0	0.16(0.10—0.20)
			● ✚	MP7130,VP15TF	M	≤3.0	0.13(0.10—0.15)
	Duplex Stainless Steel	Hardness ≤280HB	● ●	MP7130	L,M	≤3.0	0.13(0.10—0.15)
			● ●	MP7130	L,M	≤4.0	0.13(0.10—0.15)
● ●			VP15TF	M	≤3.0	0.16(0.10—0.20)	
● ●			VP15TF	M	≤4.0	0.16(0.10—0.20)	
● ✚			MP7130,VP15TF	M	≤3.0	0.13(0.10—0.15)	
● ✚			MP7130,VP15TF	M	≤4.0	0.13(0.10—0.15)	
Precipitation Hardening Stainless Steel	Hardness <450HB	●	MP7130	L,M	≤2.0	0.13(0.10—0.15)	
		● ●	MP7130	L,M	≤2.0	0.13(0.10—0.15)	
		● ●	VP15TF	M	≤2.0	0.16(0.10—0.20)	
		● ✚	MP7130,VP15TF	M	≤2.0	0.13(0.10—0.15)	
K	Gray Cast Iron	Tensile Strength ≤350MPa	● ●	MC5020	L,M	≤4.0	0.13(0.10—0.15)
			● ●	VP15TF	M,R	≤4.0	0.16(0.10—0.20)
			● ✚	MC5020,VP15TF	M,R	≤4.0	0.13(0.10—0.15)
	Ductile Cast Iron	Tensile Strength ≤800MPa	● ●	MC5020	L,M	≤4.0	0.13(0.10—0.15)
			● ●	VP15TF	M,R	≤4.0	0.16(0.10—0.20)
			● ✚	MC5020,VP15TF	M,R	≤4.0	0.13(0.10—0.15)
N	Aluminium Alloy	Si < 5%	● ● ✚	TF15	L	≤4.0	0.13(0.10—0.15)
S	Titanium Alloy	—	● ●	MP9120	L,M	≤2.0	0.10(0.05—0.13)
			● ✚	MP9130	L,M	≤2.0	0.10(0.05—0.13)
	Heat Resistant Alloy	—	● ●	MP9120	L,M	≤2.0	0.10(0.05—0.13)
			● ✚	MP9130	L,M	≤2.0	0.10(0.05—0.13)
H	Hardened Steel	Hardness 40—55HRC	●	VP15TF	M	≤2.0	0.05(0.05—0.10)
			●	VP15TF	M,R	≤2.0	0.05(0.05—0.10)

Note 1) Refer to the above table and set up cutting conditions according to cutting applications.

Cutting Conditions (Guide) :

● : Stable Cutting ● : General Cutting ✖ : Unstable Cutting

(mm)

	ae						Cutting Mode
	0.8DC≥			DC(Slot)			
	Breaker	ap	fz (mm/t.)	Breaker	ap	fz (mm/t.)	
L,M	≤3.0	0.13(0.10-0.15)	L,M	≤2.0	0.13(0.10-0.15)	Dry, Wet	
L,M	≤3.0	0.13(0.10-0.15)	L,M	≤2.0	0.13(0.10-0.15)	Dry, Wet	
M,R	≤3.0	0.16(0.10-0.20)	-	-	-	Dry, Wet	
M,R	≤3.0	0.13(0.10-0.15)	M	≤2.0	0.13(0.10-0.15)	Dry, Wet	
L,M	≤3.0	0.13(0.10-0.15)	L,M	≤2.0	0.13(0.10-0.15)	Dry, Wet	
L,M	≤3.0	0.13(0.10-0.15)	L,M	≤2.0	0.13(0.10-0.15)	Dry, Wet	
M,R	≤3.0	0.16(0.10-0.20)	-	-	-	Dry, Wet	
M,R	≤3.0	0.13(0.10-0.15)	M	≤2.0	0.13(0.10-0.15)	Dry, Wet	
L,M	≤3.0	0.13(0.10-0.15)	L,M	≤3.0	0.13(0.10-0.15)	Dry, Wet	
L,M	≤3.0	0.13(0.10-0.15)	L,M	≤2.0	0.13(0.10-0.15)	Dry, Wet	
M,R	≤3.0	0.16(0.10-0.20)	-	-	-	Dry, Wet	
M,R	≤3.0	0.13(0.10-0.15)	M	≤2.0	0.13(0.10-0.15)	Dry, Wet	
-	-	-	-	-	-	Dry, Wet	
-	-	-	-	-	-	Dry, Wet	
-	-	-	-	-	-	Dry, Wet	
-	-	-	-	-	-	Dry, Wet	
L,M	≤3.0	0.13(0.10-0.15)	-	-	-	Dry, Wet	
M	≤3.0	0.16(0.10-0.20)	-	-	-	Dry, Wet	
M	≤3.0	0.13(0.10-0.15)	-	-	-	Dry, Wet	
L,M	≤3.0	0.13(0.10-0.15)	-	-	-	Dry, Wet	
L,M	≤3.0	0.13(0.10-0.15)	-	-	-	Dry, Wet	
M	≤3.0	0.16(0.10-0.20)	-	-	-	Dry, Wet	
M	≤3.0	0.13(0.10-0.15)	-	-	-	Dry, Wet	
L,M	≤3.0	0.13(0.10-0.15)	-	-	-	Dry, Wet	
M	≤3.0	0.16(0.10-0.20)	-	-	-	Dry, Wet	
M	≤3.0	0.13(0.10-0.15)	-	-	-	Dry, Wet	
L,M	≤3.0	0.13(0.10-0.15)	-	-	-	Dry	
L,M	≤3.0	0.13(0.10-0.15)	-	-	-	Wet	
M	≤3.0	0.16(0.10-0.20)	-	-	-	Dry	
M	≤3.0	0.16(0.10-0.20)	-	-	-	Wet	
M	≤3.0	0.16(0.10-0.20)	-	-	-	Dry	
M	≤3.0	0.13(0.10-0.15)	-	-	-	Wet	
-	-	-	-	-	-	Dry, Wet	
-	-	-	-	-	-	Dry, Wet	
-	-	-	-	-	-	Dry, Wet	
-	-	-	-	-	-	Dry, Wet	
L,M	≤3.0	0.13(0.10-0.15)	L,M	≤2.0	0.13(0.10-0.15)	Dry, Wet	
M,R	≤3.0	0.16(0.10-0.20)	-	-	-	Dry, Wet	
M,R	≤3.0	0.13(0.10-0.15)	M,R	≤2.0	0.13(0.10-0.15)	Dry, Wet	
L,M	≤3.0	0.13(0.10-0.15)	L,M	≤2.0	0.13(0.10-0.15)	Dry, Wet	
M,R	≤3.0	0.16(0.10-0.20)	-	-	-	Dry, Wet	
M,R	≤3.0	0.13(0.10-0.15)	M,R	≤2.0	0.13(0.10-0.15)	Dry, Wet	
L	≤3.0	0.13(0.10-0.15)	L	≤2.0	0.13(0.10-0.15)	Wet	
-	-	-	-	-	0.10(0.05-0.13)	Wet	
-	-	-	-	-	0.10(0.05-0.13)	Wet	
-	-	-	-	-	0.10(0.05-0.13)	Wet	
-	-	-	-	-	0.10(0.05-0.13)	Wet	
-	-	-	-	-	0.05(0.05-0.10)	Dry, Wet	
-	-	-	-	-	0.05(0.05-0.10)	Dry, Wet	

K
ROTATING TOOLS

■ Ramping / Helical Milling

● Ramping

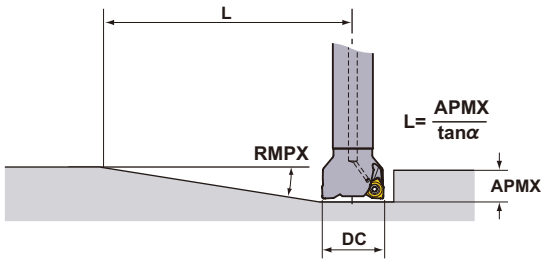

● Helical Milling

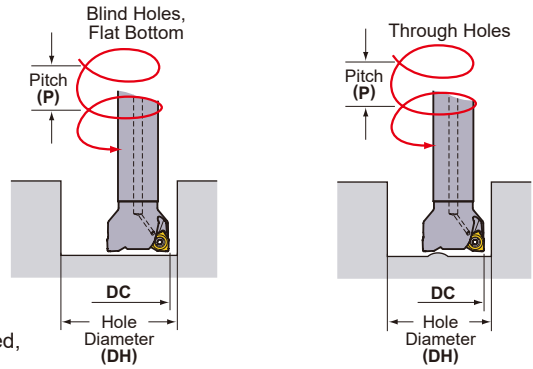

Refer to the table below for cutting conditions. For feed per tooth and cutting speed, follow the cutting conditions for slot milling.

DC	RE	APMX	Ramping		Helical Milling (Blind Hole, Flat Bottom)				Helical Milling (Through Hole)	
			RMPX	L *	DH max.	P max.	DH min.	P max.	DH min.	P max.
50	0.4	8	0.40°	1175	98.5	1.06	95.2	0.99	82.5	0.7
50	0.8	8	0.40°	1175	97.7	1.05	95.2	0.99	82.5	0.7
63	0.4	8	0.26°	1807	124.5	0.88	121.2	0.83	108.6	0.6
63	0.8	8	0.26°	1807	123.7	0.87	121.2	0.83	108.6	0.6
80	0.4	8	0.16°	2936	158.5	0.69	155.2	0.66	142.6	0.5
80	0.8	8	0.16°	2936	157.7	0.68	155.3	0.66	142.6	0.5

DC = Cutting Diameter
APMX = Depth of Cut Max.

RMPX = Ramping Angle Max.
DH = Desired Hole Diameter

P = Pitch

Note 1) When ramping and helical milling, it is recommended to reduce the feed per tooth.

Note 2) When ramping and helical milling, long continuous chips may be dispersed, take cautionary measures.

<Helical Milling>

To obtain a flat bottom surface when helical milling, it is required to remove "the uncut part" in the centre of the work material during a final pass. When helical milling, make sure that the depth of cut per helical pass doesn't exceed the maximum depth of cut (APMX).

● Plunging

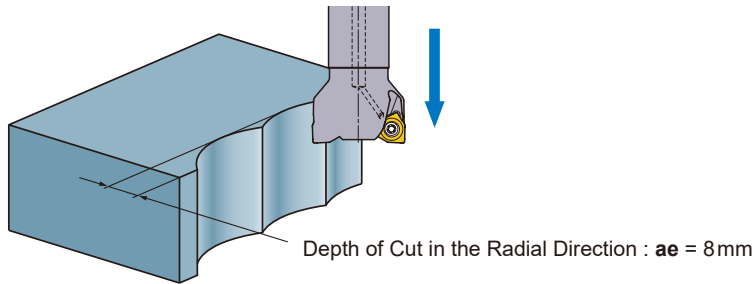

SHOULDER MILLING

<STRONG EDGE TYPE FOR CAST IRON>



VOX400

P M **K** N S H

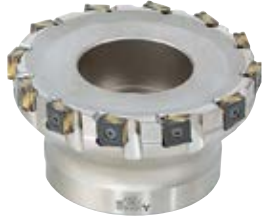

Fig.1

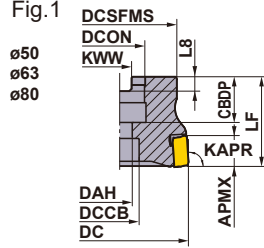

Fig.2

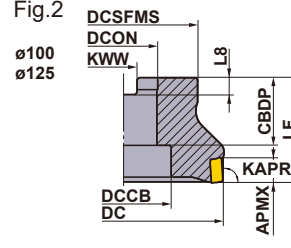
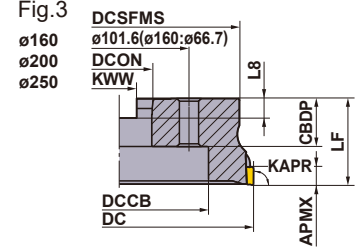

Fig.3



Right hand tool holder only.

ARBOR TYPE

KAPR : 90°
GAMP : -6° GAMF : -18°

Type	Order Number	Stock	Number of Teeth	Dimensions(mm)								*2 WT (kg)	APMX (mm)	Fig.	*1		
				DC	LF	DCON	CBDP	DAH	DCCB	DCSFMS	KWW				L8	Clamp Screw	Wrench
Coarse Pitch	VOX400-050A03R	●	3	50	40	22	20	11	17	41	10.4	6.3	0.3	10	1	CS401160T	TKY15T
	VOX400-063A04R	●	4	63	40	22	20	11	17	50	10.4	6.3	0.6	10	1	CS401160T	TKY15T
	VOX400-080A04R	●	4	80	50	27	23	13	20	56	12.4	7	1	10	1	CS401160T	TKY15T
	VOX400-100B06R	●	6	100	50	32	32	—	45	78	14.4	8	1.7	10	2	CS401160T	TKY15T
	VOX400-125B08R	●	8	125	63	40	32	—	56	89	16.4	9	3	10	2	CS401160T	TKY15T
	VOX400-160C10R	●	10	160	63	40	29	—	56	120	16.4	9	5.4	10	3	CS401160T	TKY15T
	VOX400-200C12R	●	12	200	63	60	32	—	130	175	25.7	14.22	8.1	10	3	CS401160T	TKY15T
VOX400-250C16R	●	16	250	63	60	32	—	180	210	25.7	14.22	11.8	10	3	CS401160T	TKY15T	
Fine Pitch	VOX400-050A05R	●	5	50	40	22	20	11	17	41	10.4	6.3	0.3	10	1	CS401160T	TKY15T
	VOX400-063A06R	●	6	63	40	22	20	11	17	50	10.4	6.3	0.6	10	1	CS401160T	TKY15T
	VOX400-080A08R	●	8	80	50	27	23	13	20	56	12.4	7	1	10	1	CS401160T	TKY15T
	VOX400-100B10R	●	10	100	50	32	32	—	45	78	14.4	8	1.7	10	2	CS401160T	TKY15T
	VOX400-125B12R	●	12	125	63	40	32	—	56	89	16.4	9	3	10	2	CS401160T	TKY15T
	VOX400-160C16R	●	16	160	63	40	29	—	56	120	16.4	9	5.4	10	3	CS401160T	TKY15T
	VOX400-200C20R	●	20	200	63	60	32	—	130	175	25.7	14.22	8.1	10	3	CS401160T	TKY15T
VOX400-250C24R	●	24	250	63	60	32	—	180	210	25.7	14.22	11.8	10	3	CS401160T	TKY15T	
Extra Fine Pitch	VOX400-063A08R	●	8	63	40	22	20	11	17	50	10.4	6.3	0.5	10	1	CS401160T	TKY15T
	VOX400-080A10R	●	10	80	50	27	23	13	20	56	12.4	7	1.0	10	1	CS401160T	TKY15T
	VOX400-100B12R	●	12	100	50	32	32	—	45	78	14.4	8	1.6	10	2	CS401160T	TKY15T
	VOX400-125B16R	●	16	125	63	40	32	—	56	89	16.4	9	2.8	10	2	CS401160T	TKY15T
	VOX400-160C20R	●	20	160	63	40	29	—	56	120	16.4	9	5.2	10	3	CS401160T	TKY15T
	VOX400-200C26R	★	26	200	63	60	32	—	130	175	25.7	14.22	7.9	10	3	CS401160T	TKY15T
VOX400-250C34R	★	34	250	63	60	32	—	180	210	25.7	14.22	11.5	10	3	CS401160T	TKY15T	

*1 Clamp Torque (N · m) : CS401160T=3.5

*2 WT : Tool Weight

● : Inventory maintained. ★ : Inventory maintained in Japan.

SPARE PARTS > N001
TECHNICAL DATA > P001

K065

K

ROTATING TOOLS

ROTATING TOOLS

ROTATING TOOLS

INSERTS

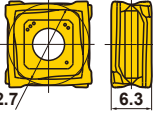
Work Material	K Cast Iron		Coated	Cutting Conditions (Guide) :		
				● : Stable Cutting	● : General Cutting	
Shape	Order Number	Class	Honing	MC5020	VP15TF	Geometry
	SONX1206PER SONX1206PEL	N N	E E	● ★	● ●	 ø12.7 / 6.3 Right hand tool holder shown.

WIPER INSERTS

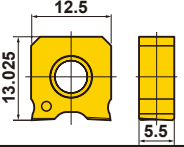
Work Material	K Cast Iron		Coated	Cutting Conditions (Guide) :		
				● : Stable Cutting	● : General Cutting	
Shape	Order Number	Class	Honing	MC5020	VP15TF	Geometry
	WOEX1206PER5C	E	E	●		 12.5 13.025 5.5

* Left hand insert use for the side cutter (special products).

RECOMMENDED CUTTING CONDITIONS

■ VOX400 (Standard Pitch)

Work Material	Tensile Strength	Insert Grade	Cutting Speed (m/min)	φ50 - φ250		
				Radial Depth of Cut ae (mm)	Depth of Cut ap (mm)	Feed per Tooth fz (mm/t.)
K Gray Cast Iron	≤200MPa	MC5020	300(250-350)	≤DC	≤10	0.4(0.3-0.5)
		VP15TF	250(200-300)	≤DC	≤10	0.4(0.3-0.5)
	≤350MPa	MC5020	220(150-300)	≤DC	≤10	0.3(0.2-0.4)
		VP15TF	200(150-300)	≤DC	≤10	0.3(0.2-0.4)
Ductile Cast Iron	≤450MPa	MC5020	200(150-250)	≤DC	≤10	0.3(0.2-0.4)
		VP15TF	170(150-200)	≤DC	≤10	0.3(0.2-0.4)
	≤800MPa	MC5020	170(150-200)	≤DC	≤10	0.2(0.1-0.3)
		VP15TF	150(100-200)	≤DC	≤10	0.2(0.1-0.3)

■ VOX400 (Fine Pitch)

Work Material	Tensile Strength	Insert Grade	Cutting Speed (m/min)	φ50, φ63			φ80		
				Radial Depth of Cut ae (mm)	Depth of Cut ap (mm)	Feed per Tooth fz (mm/t.)	Radial Depth of Cut ae (mm)	Depth of Cut ap (mm)	Feed per Tooth fz (mm/t.)
K Gray Cast Iron	≤200MPa	MC5020	300(250-350)	≤DC	≤10	0.4(0.3-0.5)	≤DC	≤10	0.4(0.3-0.5)
		VP15TF	250(200-300)	≤DC	≤10	0.4(0.3-0.5)	≤DC	≤10	0.4(0.3-0.5)
	≤350MPa	MC5020	220(150-300)	≤DC	≤10	0.3(0.2-0.4)	≤DC	≤10	0.3(0.2-0.4)
		VP15TF	200(150-300)	≤DC	≤10	0.3(0.2-0.4)	≤DC	≤10	0.3(0.2-0.4)
Ductile Cast Iron	≤450MPa	MC5020	200(150-250)	≤0.8DC	≤10	0.3(0.2-0.4)	≤0.6DC	≤10	0.3(0.2-0.4)
		VP15TF	170(150-200)	≤0.8DC	≤10	0.3(0.2-0.4)	≤0.6DC	≤10	0.3(0.2-0.4)
	≤800MPa	MC5020	170(150-200)	≤0.8DC	≤10	0.2(0.1-0.3)	≤0.6DC	≤10	0.2(0.1-0.3)
		VP15TF	150(100-200)	≤0.8DC	≤10	0.2(0.1-0.3)	≤0.6DC	≤10	0.2(0.1-0.3)

Work Material	Tensile Strength	Insert Grade	Cutting Speed (m/min)	φ100			φ125		
				Radial Depth of Cut ae (mm)	Depth of Cut ap (mm)	Feed per Tooth fz (mm/t.)	Radial Depth of Cut ae (mm)	Depth of Cut ap (mm)	Feed per Tooth fz (mm/t.)
K Gray Cast Iron	≤200MPa	MC5020	300(250-350)	≤DC	≤10	0.4(0.3-0.5)	≤DC	≤10	0.4(0.3-0.5)
		VP15TF	250(200-300)	≤DC	≤10	0.4(0.3-0.5)	≤DC	≤10	0.4(0.3-0.5)
	≤350MPa	MC5020	220(150-300)	≤DC	≤10	0.3(0.2-0.4)	≤DC	≤10	0.3(0.2-0.4)
		VP15TF	200(150-300)	≤DC	≤10	0.3(0.2-0.4)	≤DC	≤10	0.3(0.2-0.4)
Ductile Cast Iron	≤450MPa	MC5020	200(150-250)	≤0.5DC	≤10	0.3(0.2-0.4)	≤0.4DC	≤10	0.3(0.2-0.4)
		VP15TF	170(150-200)	≤0.5DC	≤10	0.3(0.2-0.4)	≤0.4DC	≤10	0.3(0.2-0.4)
	≤800MPa	MC5020	170(150-200)	≤0.5DC	≤10	0.2(0.1-0.3)	≤0.4DC	≤10	0.2(0.1-0.3)
		VP15TF	150(100-200)	≤0.5DC	≤10	0.2(0.1-0.3)	≤0.4DC	≤10	0.2(0.1-0.3)

● : Inventory maintained. ★ : Inventory maintained in Japan.

(10 inserts in one case)

Work Material	Tensile Strength	Insert Grade	Cutting Speed (m/min)	φ160			φ200-φ250		
				Radial Depth of Cut ae (mm)	Depth of Cut ap (mm)	Feed per Tooth fz (mm/t.)	Radial Depth of Cut ae (mm)	Depth of Cut ap (mm)	Feed per Tooth fz (mm/t.)
Gray Cast Iron	≤200MPa	MC5020	300(250-350)	≤DC	≤10	0.4(0.3-0.5)	≤DC	≤10	0.4(0.3-0.5)
		VP15TF	250(200-300)	≤DC	≤10	0.4(0.3-0.5)	≤DC	≤10	0.4(0.3-0.5)
	≤350MPa	MC5020	220(150-300)	≤DC	≤10	0.3(0.2-0.4)	≤DC	≤10	0.3(0.2-0.4)
		VP15TF	200(150-300)	≤DC	≤10	0.3(0.2-0.4)	≤DC	≤10	0.3(0.2-0.4)
Ductile Cast Iron	≤450MPa	MC5020	200(150-250)	≤0.3DC	≤10	0.3(0.2-0.4)	≤0.2DC	≤10	0.3(0.2-0.4)
		VP15TF	170(150-200)	≤0.3DC	≤10	0.3(0.2-0.4)	≤0.2DC	≤10	0.3(0.2-0.4)
	≤800MPa	MC5020	170(150-200)	≤0.3DC	≤10	0.2(0.1-0.3)	≤0.2DC	≤10	0.2(0.1-0.3)
		VP15TF	150(100-200)	≤0.3DC	≤10	0.2(0.1-0.3)	≤0.2DC	≤10	0.2(0.1-0.3)

Note 1) DC is cutter diameter.

Note 2) When using wiper inserts, please reduce the feed per tooth to half the normal rate.

■ VOX400 (Extra Fine Pitch)

Work Material	Tensile Strength	Insert Grade	Cutting Speed (m/min)	φ63			φ80		
				Radial Depth of Cut ae (mm)	Depth of Cut ap (mm)	Feed per Tooth fz (mm/t.)	Radial Depth of Cut ae (mm)	Depth of Cut ap (mm)	Feed per Tooth fz (mm/t.)
Gray Cast Iron	≤200MPa	MC5020	300(250-350)	≤DC	≤10	0.4(0.3-0.5)	≤DC	≤10	0.4(0.3-0.5)
		VP15TF	250(200-300)	≤DC	≤10	0.4(0.3-0.5)	≤DC	≤10	0.4(0.3-0.5)
	≤350MPa	MC5020	220(150-300)	≤DC	≤10	0.3(0.2-0.4)	≤DC	≤10	0.3(0.2-0.4)
		VP15TF	200(150-300)	≤DC	≤10	0.3(0.2-0.4)	≤DC	≤10	0.3(0.2-0.4)
Ductile Cast Iron	≤450MPa	MC5020	200(150-250)	≤0.6DC	≤10	0.3(0.2-0.4)	≤0.5DC	≤10	0.3(0.2-0.4)
		VP15TF	170(150-200)	≤0.6DC	≤10	0.3(0.2-0.4)	≤0.5DC	≤10	0.3(0.2-0.4)
	≤800MPa	MC5020	170(150-200)	≤0.6DC	≤10	0.2(0.1-0.3)	≤0.5DC	≤10	0.2(0.1-0.3)
		VP15TF	150(100-200)	≤0.6DC	≤10	0.2(0.1-0.3)	≤0.5DC	≤10	0.2(0.1-0.3)

Work Material	Tensile Strength	Insert Grade	Cutting Speed (m/min)	φ100			φ125		
				Radial Depth of Cut ae (mm)	Depth of Cut ap (mm)	Feed per Tooth fz (mm/t.)	Radial Depth of Cut ae (mm)	Depth of Cut ap (mm)	Feed per Tooth fz (mm/t.)
Gray Cast Iron	≤200MPa	MC5020	300(250-350)	≤DC	≤10	0.4(0.3-0.5)	≤DC	≤10	0.4(0.3-0.5)
		VP15TF	250(200-300)	≤DC	≤10	0.4(0.3-0.5)	≤DC	≤10	0.4(0.3-0.5)
	≤350MPa	MC5020	220(150-300)	≤DC	≤10	0.3(0.2-0.4)	≤DC	≤10	0.3(0.2-0.4)
		VP15TF	200(150-300)	≤DC	≤10	0.3(0.2-0.4)	≤DC	≤10	0.3(0.2-0.4)
Ductile Cast Iron	≤450MPa	MC5020	200(150-250)	≤0.4DC	≤10	0.3(0.2-0.4)	≤0.3DC	≤10	0.3(0.2-0.4)
		VP15TF	170(150-200)	≤0.4DC	≤10	0.3(0.2-0.4)	≤0.3DC	≤10	0.3(0.2-0.4)
	≤800MPa	MC5020	170(150-200)	≤0.4DC	≤10	0.2(0.1-0.3)	≤0.3DC	≤10	0.2(0.1-0.3)
		VP15TF	150(100-200)	≤0.4DC	≤10	0.2(0.1-0.3)	≤0.3DC	≤10	0.2(0.1-0.3)

Work Material	Tensile Strength	Insert Grade	Cutting Speed (m/min)	φ160			φ200-φ250		
				Radial Depth of Cut ae (mm)	Depth of Cut ap (mm)	Feed per Tooth fz (mm/t.)	Radial Depth of Cut ae (mm)	Depth of Cut ap (mm)	Feed per Tooth fz (mm/t.)
Gray Cast Iron	≤200MPa	MC5020	300(250-350)	≤DC	≤10	0.4(0.3-0.5)	≤DC	≤10	0.4(0.3-0.5)
		VP15TF	250(200-300)	≤DC	≤10	0.4(0.3-0.5)	≤DC	≤10	0.4(0.3-0.5)
	≤350MPa	MC5020	220(150-300)	≤DC	≤10	0.3(0.2-0.4)	≤DC	≤10	0.3(0.2-0.4)
		VP15TF	200(150-300)	≤DC	≤10	0.3(0.2-0.4)	≤DC	≤10	0.3(0.2-0.4)
Ductile Cast Iron	≤450MPa	MC5020	200(150-250)	≤0.25DC	≤10	0.3(0.2-0.4)	≤0.15DC	≤10	0.3(0.2-0.4)
		VP15TF	170(150-200)	≤0.25DC	≤10	0.3(0.2-0.4)	≤0.15DC	≤10	0.3(0.2-0.4)
	≤800MPa	MC5020	170(150-200)	≤0.25DC	≤10	0.2(0.1-0.3)	≤0.15DC	≤10	0.2(0.1-0.3)
		VP15TF	150(100-200)	≤0.25DC	≤10	0.2(0.1-0.3)	≤0.15DC	≤10	0.2(0.1-0.3)

Note 1) DC is cutter diameter.

Note 2) When using wiper insert, please reduce the feed per tooth to half the normal rate.

ROTATING TOOLS

SHOULDER MILLING

<GENERAL CUTTING>



ASX400

- P
- M
- K
- N
- S
- H

K

ROTATING TOOLS



ARBOR TYPE

KAPR :90°

GAMP:+11° GAMF:-9°-11°

No coolant hole

Fig.1

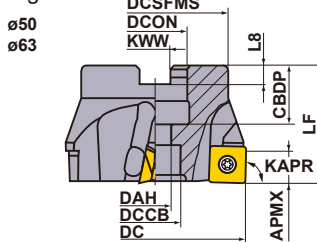

Fig.2

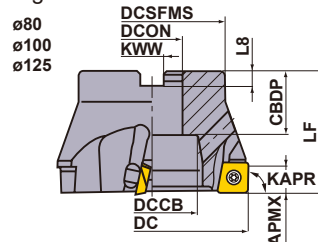

Fig.3

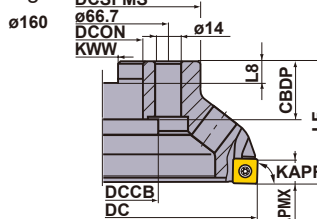
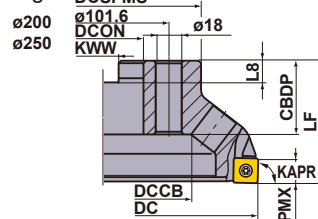

Fig.4



Right hand tool holder only.

Type	Order Number	Stock	Number of Teeth	Dimensions(mm)									WT [*] (kg)	APMX (mm)	Fig.
				DC	LF	DCON	CBDP	DAH	DCCB	DCSFMS	KWW	L8			
Coarse Pitch	ASX400-050A03R	●	3	50	40	22	20	11	17	41	10.4	6.3	0.3	10	1
	ASX400-063A04R	●	4	63	40	22	20	11	17	50	10.4	6.3	0.5	10	1
	ASX400-080B04R	●	4	80	50	27	29	—	38	60	12.4	7	0.9	10	2
	ASX400-100B05R	●	5	100	50	32	32	—	45	70	14.4	8	1.4	10	2
	ASX400-125B06R	●	6	125	63	40	32	—	60	80	16.4	9	2.3	10	2
	ASX400-160C08R	●	8	160	63	40	29	—	56	100	16.4	9	3.6	10	3
	ASX400-200C10R	●	10	200	63	60	32	—	135	160	25.7	14.22	6.3	10	4
	ASX400-250C12R	●	12	250	63	60	32	—	180	210	25.7	14.22	10.8	10	4
Fine Pitch	ASX400-050A04R	●	4	50	40	22	20	11	17	41	10.4	6.3	0.3	10	1
	ASX400-063A05R	●	5	63	40	22	20	11	17	50	10.4	6.3	0.5	10	1
	ASX400-080B06R	●	6	80	50	27	29	—	38	60	12.4	7	0.9	10	2
	ASX400-100B07R	●	7	100	50	32	32	—	45	70	14.4	8	1.4	10	2
	ASX400-125B08R	●	8	125	63	40	32	—	60	80	16.4	9	2.2	10	2
	ASX400-160C12R	●	12	160	63	40	29	—	56	100	16.4	9	3.5	10	3
	ASX400-200C16R	●	16	200	63	60	32	—	135	160	25.7	14.22	6.2	10	4
	ASX400-250C18R	●	18	250	63	60	32	—	180	210	25.7	14.22	10.7	10	4
Extra Fine Pitch	ASX400-050A05R	●	5	50	40	22	20	11	17	41	10.4	6.3	0.3	10	1
	ASX400-063A06R	●	6	63	40	22	20	11	17	50	10.4	6.3	0.5	10	1
	ASX400-080B08R	●	8	80	50	27	29	—	38	60	12.4	7	0.9	10	2
	ASX400-100B10R	●	10	100	50	32	32	—	45	70	14.4	8	1.4	10	2
	ASX400-125B12R	●	12	125	63	40	32	—	60	80	16.4	9	2.1	10	2
	ASX400-160C15R	●	15	160	63	40	29	—	56	100	16.4	9	3.4	10	3
	ASX400-200C19R	★	19	200	63	60	32	—	135	160	25.7	14.22	6.2	10	4
	ASX400-250C22R	★	22	250	63	60	32	—	180	210	25.7	14.22	10.5	10	4

* WT : Tool Weight

● : Inventory maintained. ★ : Inventory maintained in Japan.

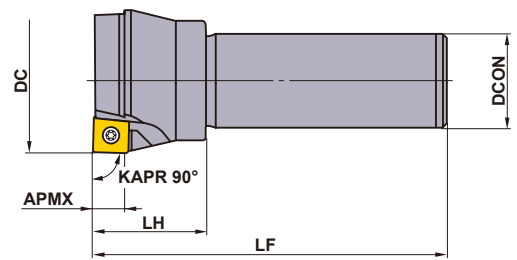
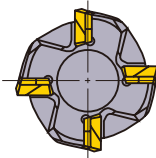

SHANK TYPE

Right hand tool holder only.

Type	Order Number	Stock R	Number of Teeth	Dimensions(mm)				
				DC	LF	DCON	LH	APMX
Coarse Pitch	ASX400R403S32	★	3	40	125	32	40	10
Fine Pitch	ASX400R504S32	★	4	50	125	32	40	10
	ASX400R635S32	★	5	63	125	32	40	10

SPARE PARTS

Tool Holder Number		*	*		
	Shim	Shim Screw	Clamp Screw	Wrench (Insert)	Wrench (Shim)
ASX400	STASX400N	WCS503507H	TPS35	TIP15T	HKY35R

* Clamp Torque (N • m) : WCS503507H=5.0, TPS35=3.5

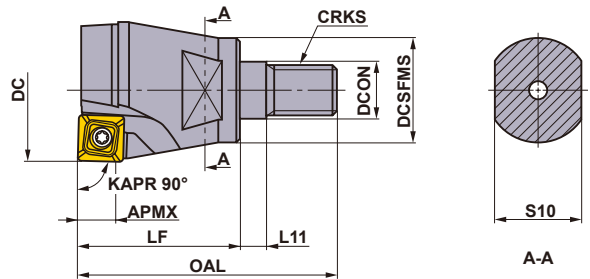
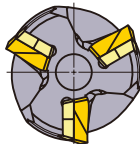

SCREW-IN TYPE

Right hand tool holder only.

Order Number	Stock R	Teeth	Dimensions (mm)									*2 WT (kg)		*1	*1		
			DC	DCON	DCSFMS	OAL	LF	L11	S10	CRKS	APMX		Shim	Shim Screw	Clamp Screw	Wrench (Insert)	Wrench (Shim)
ASX400R322M16	●	2	32	17	29	65	42	6	22	M16	10	0.3	—	WCS503507H	TPS35	TIP15T	HKY35R
ASX400R403M16	●	3	40	17	29	70	47	6	22	M16	10	0.3	STASX400N	WCS503507H	TPS35	TIP15T	HKY35R

*1 Clamp Torque (N • m) : WCS503507H=5.0, TPS35=3.5

*2 WT : Tool Weight

Note 1) For screw-in type arbors, refer to page K244.

RECOMMENDED CUTTING CONDITIONS

Work Material	Hardness	Grade	Cutting Speed (m/min)	Finish—Light Cutting		Light—Rough Cutting		Medium—Heavy Cutting	
				Feed per Tooth (mm/t.)	Breaker	Feed per Tooth (mm/t.)	Breaker	Feed per Tooth (mm/t.)	Breaker
P Mild Steel	≤180HB	F7030	280 (210—350)	0.18 (0.08—0.28)	JL	0.20 (0.10—0.30)	JM	0.25 (0.10—0.35)	JH
		MP6120 VP15TF	250 (200—300)	0.18 (0.08—0.28)	JL	0.20 (0.10—0.30)	JM	0.25 (0.10—0.35)	JH FT
		MP6130	240 (190—290)	0.18 (0.08—0.28)	JL	0.20 (0.10—0.30)	JM	0.25 (0.10—0.35)	JH
		VP30RT	230 (180—280)	0.18 (0.08—0.28)	JL	0.20 (0.10—0.30)	JM	0.25 (0.10—0.35)	JH
		NX4545	180 (130—230)	0.15 (0.07—0.23)	JL	0.18 (0.10—0.28)	JM	—	—
Carbon Steel Alloy Steel	180—280HB	F7030	250 (200—300)	0.15 (0.07—0.23)	JL	0.18 (0.10—0.28)	JM	0.20 (0.10—0.30)	JH
		MP6120 VP15TF	220 (170—270)	0.15 (0.07—0.23)	JL	0.18 (0.10—0.28)	JM	0.20 (0.10—0.30)	JH FT
		MP6130	180 (150—230)	0.15 (0.07—0.23)	JL	0.18 (0.10—0.28)	JM	0.20 (0.10—0.30)	JH
		VP30RT	150 (120—180)	0.15 (0.07—0.23)	JL	0.18 (0.10—0.28)	JM	0.20 (0.10—0.30)	JH
		NX4545	150 (120—180)	0.13 (0.06—0.20)	JL	0.15 (0.10—0.25)	JM	—	—
	280—350HB	F7030	180 (130—230)	0.13 (0.06—0.20)	JL	0.15 (0.10—0.25)	JM	0.18 (0.10—0.28)	JH
		MP6120 VP15TF	140 (100—180)	0.13 (0.06—0.20)	JL	0.15 (0.10—0.25)	JM	0.18 (0.10—0.28)	JH FT
		MP6130	120 (90—150)	0.13 (0.06—0.20)	JL	0.15 (0.10—0.25)	JM	0.18 (0.10—0.28)	JH
		VP30RT	100 (80—160)	0.13 (0.06—0.20)	JL	0.15 (0.10—0.25)	JM	0.18 (0.10—0.28)	JH
		NX4545	100 (80—160)	0.10 (0.05—0.15)	JL	0.13 (0.10—0.20)	JM	—	—
M Stainless Steel	≤270HB	MP7130 VP15TF	220 (170—270)	0.15 (0.07—0.23)	JL	0.18 (0.10—0.28)	JM	0.20 (0.10—0.30)	JH FT
		MP7140 VP30RT	200 (150—250)	0.15 (0.07—0.23)	JL	0.18 (0.10—0.28)	JM	0.20 (0.10—0.30)	JH
		NX4545	150 (120—180)	0.15 (0.07—0.23)	JL	0.18 (0.10—0.28)	JM	—	—
K Cast Iron Ductile Cast Iron	Tensile Strength ≤450MPa	MC5020	200 (150—250)	—	—	0.20 (0.10—0.30)	JM	0.25 (0.10—0.35)	JH FT
		VP15TF	180 (130—230)	0.18 (0.10—0.28)	JL	0.20 (0.10—0.30)	JM	0.25 (0.10—0.35)	JH FT
N Aluminium Alloy	—	HTi10	650 (300—1000)	0.15 (0.10—0.20)	JP	0.20 (0.10—0.30)	JP	0.30 (0.20—0.40)	JP
S Titanium Alloy Heat Resistant Alloy (Inconel etc.)	—	MP9120 VP15TF	50 (40—60)	0.12 (0.05—0.20)	JL	0.15 (0.05—0.20)	JM	0.18 (0.10—0.28)	JH FT
		MP9130	45 (30—55)	0.10 (0.05—0.20)	JL	0.15 (0.05—0.20)	JM	0.18 (0.10—0.28)	JH FT
	—	MP9120 VP15TF	40 (20—50)	0.12 (0.05—0.20)	JL	0.15 (0.05—0.20)	JM	0.18 (0.10—0.28)	JH FT
		MP9130	35 (15—45)	0.10 (0.05—0.20)	JL	0.15 (0.05—0.20)	JM	0.18 (0.10—0.28)	JH FT
H Hardened Steel	40—55HRC	VP15TF	80 (60—100)	0.08 (0.04—0.13)	JL	0.10 (0.05—0.15)	JM	0.12 (0.07—0.17)	JH FT

● Revolution (min⁻¹)=(1000 x Cutting Speed)÷(3.14 x DC)

● Table Feed (mm/min)=Feed per Tooth x Number of Teeth x Cutter Revolution

INSTRUCTIONS FOR USING INSERTS

■ Instructions for use of the JP breaker

- The JP breaker has sharp cutting edges. Wear gloves when handling.
- When machining aluminium alloy, welding to the cutting edge tends to occur, often leading to insert failure. To prevent this, wet cutting is recommended.

■ Instructions for use of wiper inserts



- Wiper inserts for the ASX400 are single-cornered.
- When installing the wiper insert, place the insert so that the small chamfer is located as shown.
- The peripheral cutting edge of the wiper insert is located further back than general inserts. Beware of wear of the insert just behind the wiper insert.
- When using the wiper, set the following standard conditions. Depth of Cut (ap) ≤0.5 mm, Feed per Tooth (fz)≤0.2 mm/t.

K

ROTATING TOOLS

ROTATING TOOLS

MULTI-FUNCTIONAL MILLING



WJX09

NEW

- P M K N S H

K

ROTATING TOOLS



Fig.1
ø40

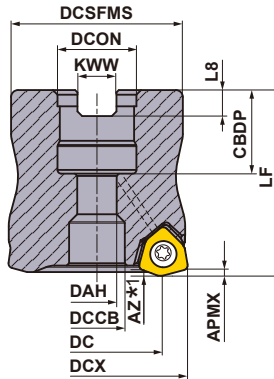
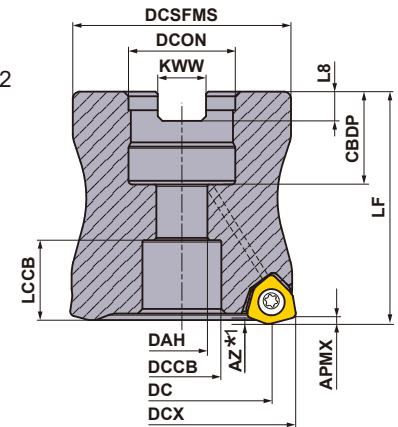

Fig.2
ø50
ø52
ø63
ø66



Right hand tool holder only.

DCON (mm)	Set Bolt	Geometry
ø16	HFF08033H	①
ø22	HSC10030H	②
ø27	HSC12035H	

ARBOR TYPE

GAMP: -6° GAMF: -11° -10°
With Coolant Hole

DCX (mm)	Order Number	Stock R	Number of Teeth	Dimensions (mm)			WT*2 (kg)	APMX (mm)	RPMX (min ⁻¹)	Fig.	Insert Type
				DC	LF	DCON					
40	WJX09-040A04AR	●	4	28.8	40	16	0.2	1.2	23200	1	JOMU0905
40	WJX09-040A05AR	●	5	28.8	40	16	0.2	1.2	23200	1	JOMU0905
50	WJX09-050A04AR	●	4	38.8	50	22	0.4	1.2	20000	2	JOMU0905
50	WJX09-050A06AR	●	6	38.8	50	22	0.4	1.2	20000	2	JOMU0905
52	WJX09-052A06AR	●	6	40.8	50	22	0.5	1.2	19500	2	JOMU0905
63	WJX09-063A05AR	●	5	51.8	50	22	0.8	1.2	17300	2	JOMU0905
63	WJX09-063A07AR	●	7	51.8	50	22	0.8	1.2	17300	2	JOMU0905
63	WJX09-063X07AR	●	7	51.8	50	27	0.7	1.2	17300	2	JOMU0905
66	WJX09-066X07AR	●	7	54.8	50	27	0.8	1.2	16800	2	JOMU0905

*1 Refer to page K077, for the maximum drilling depth (AZ).

*2 WT : Tool Weight

Note 1) The maximum allowable spindle speeds (RPMX) are set to ensure tool and insert stability.

Note 2) When using at high spindle speeds, ensure that the tool and arbor are correctly balanced.

MOUNTING DIMENSIONS

DCX (mm)	Order Number	Dimensions (mm)								Fig.
		DCON	CBDP	DAH	DCCB	LCCB	DCSFMS	KWW	L8	
40	WJX09-040A04AR	16	18	8.5	12	—	37	8.4	5.6	1
40	WJX09-040A05AR	16	18	8.5	12	—	37	8.4	5.6	1
50	WJX09-050A04AR	22	20	11	17	17.2	47	10.4	6.3	2
50	WJX09-050A06AR	22	20	11	17	17.2	47	10.4	6.3	2
52	WJX09-052A06AR	22	20	11	17	17.2	47	10.4	6.3	2
63	WJX09-063A05AR	22	20	11	17	17.2	60	10.4	6.3	2
63	WJX09-063A07AR	22	20	11	17	17.2	60	10.4	6.3	2
63	WJX09-063X07AR	27	23	13	20	16.2	60	12.4	7	2
66	WJX09-066X07AR	27	23	13	20	16.2	60	12.4	7	2

● : Inventory maintained. ★ : Inventory maintained in Japan.

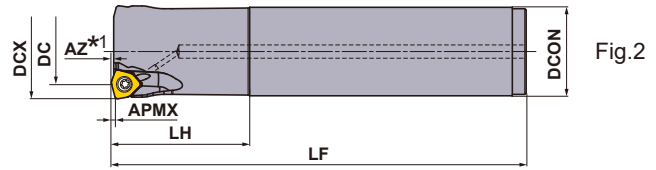
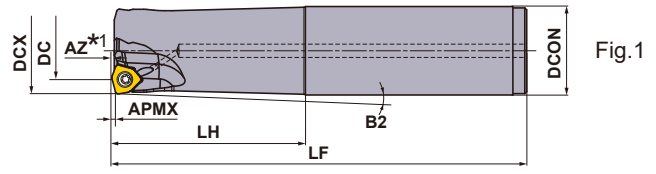

Right hand tool holder only.

SHANK TYPE

With Coolant Hole

DCX (mm)	Order Number	Stock R	Number of Teeth	Dimensions (mm)					APMX (mm)	RPMX (min ⁻¹)	Fig.	Insert Type
				DC	LF	LH	DCON	B2				
25	WJX09R2502SA25S	●	2	14	140	60	25	1.09°	1.2	33500	1	JOMU0905
25	WJX09R2503SA25S	●	3	14	140	60	25	1.09°	1.2	33500	1	JOMU0905
25	WJX09R2502SA25L	●	2	14	200	120	25	0.54°	1.2	33500	1	JOMU0905
25	WJX09R2503SA25L	★	3	14	200	120	25	0.54°	1.2	33500	1	JOMU0905
25	WJX09R2502SA25EL	★	2	14	300	180	25	0.35°	1.2	33500	1	JOMU0905
28	WJX09R2802SA25S	★	2	16.9	140	40	25	—	1.2	30300	2	JOMU0905
28	WJX09R2803SA25S	●	3	16.9	140	40	25	—	1.2	30300	2	JOMU0905
28	WJX09R2802SA25L	●	2	16.9	200	40	25	—	1.2	30300	2	JOMU0905
28	WJX09R2803SA25L	★	3	16.9	200	40	25	—	1.2	30300	2	JOMU0905
28	WJX09R2802SA25EL	★	2	16.9	300	40	25	—	1.2	30300	2	JOMU0905
32	WJX09R3202SA32S	★	2	20.9	150	70	32	0.93°	1.2	27300	1	JOMU0905
32	WJX09R3203SA32S	●	3	20.9	150	70	32	0.93°	1.2	27300	1	JOMU0905
32	WJX09R3202SA32L	★	2	20.9	200	120	32	0.54°	1.2	27300	1	JOMU0905
32	WJX09R3203SA32L	●	3	20.9	200	120	32	0.54°	1.2	27300	1	JOMU0905
32	WJX09R3202SA32EL	★	2	20.9	300	180	32	0.35°	1.2	27300	1	JOMU0905
35	WJX09R3503SA32S	★	3	23.8	150	50	32	—	1.2	25500	2	JOMU0905
35	WJX09R3504SA32S	★	4	23.8	150	50	32	—	1.2	25500	2	JOMU0905
35	WJX09R3503SA32L	★	3	23.8	200	50	32	—	1.2	25500	2	JOMU0905
35	WJX09R3504SA32L	★	4	23.8	200	50	32	—	1.2	25500	2	JOMU0905
35	WJX09R3502SA32EL	★	2	23.8	300	50	32	—	1.2	25500	2	JOMU0905
40	WJX09R4003SA32S	★	3	28.8	150	50	32	—	1.2	23200	2	JOMU0905
40	WJX09R4004SA32S	●	4	28.8	150	50	32	—	1.2	23200	2	JOMU0905
40	WJX09R4003SA32L	★	3	28.8	250	50	32	—	1.2	23200	2	JOMU0905
40	WJX09R4004SA32L	★	4	28.8	250	50	32	—	1.2	23200	2	JOMU0905
40	WJX09R4003SA32EL	★	3	28.8	300	50	32	—	1.2	23200	2	JOMU0905

*1 Refer to page K077, for the maximum drilling depth (AZ).

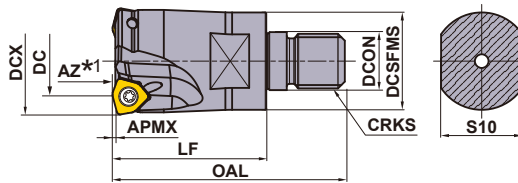

SCREW-IN TYPE

With Coolant Hole

Right hand tool holder only.

DCX (mm)	Order Number	Stock R	Number of Teeth	Dimensions (mm)							WT *2 (kg)	APMX (mm)	RPMX (min ⁻¹)	Insert Type
				DC	LF	OAL	DCON	DCSFMS	S10	CRKS				
25	WJX09R2502AM1235	●	2	14	35	57	12.5	23.5	19	M12	0.1	1.2	33500	JOMU0905
25	WJX09R2503AM1235	●	3	14	35	57	12.5	23.5	19	M12	0.1	1.2	33500	JOMU0905
28	WJX09R2802AM1235	●	2	16.9	35	57	12.5	23.5	19	M12	0.1	1.2	30300	JOMU0905
28	WJX09R2803AM1235	●	3	16.9	35	57	12.5	23.5	19	M12	0.1	1.2	30300	JOMU0905
32	WJX09R3202AM1645	●	2	20.9	45	68	17.0	28.5	24	M16	0.2	1.2	27300	JOMU0905
32	WJX09R3203AM1645	●	3	20.9	45	68	17.0	28.5	24	M16	0.2	1.2	27300	JOMU0905
35	WJX09R3502AM1645	●	2	23.8	45	68	17.0	28.5	24	M16	0.3	1.2	25500	JOMU0905
35	WJX09R3503AM1645	●	3	23.8	45	68	17.0	28.5	24	M16	0.2	1.2	25500	JOMU0905
35	WJX09R3504AM1645	●	4	23.8	35	68	17.0	28.5	24	M16	0.2	1.2	25500	JOMU0905
40	WJX09R4003AM1645	●	3	28.8	45	68	17.0	28.5	24	M16	0.3	1.2	23200	JOMU0905
40	WJX09R4004AM1645	●	4	28.8	45	68	17.0	28.5	24	M16	0.3	1.2	23200	JOMU0905
40	WJX09R4005AM1645	●	5	28.8	45	68	17.0	28.5	24	M16	0.3	1.2	23200	JOMU0905

*1 Refer to page K077, for the maximum drilling depth (AZ).



*2 WT : Tool Weight

Note 1) For screw-in type arbors, refer to page K244.

ARBORS > K244
 SPARE PARTS > N001
 TECHNICAL DATA > P001

ROTATING TOOLS

SPARE PARTS

Tool Holder Type	 *		
	Clamp Screw	Wrench (Insert)	Anti-seize Lubricant
WJX09	TPS3R	TIP10D	MK1KS

* Clamp Torque (N • m) : TPS3R = 2.0

K

ROTATING TOOLS

INSERTS

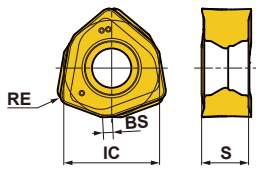
Work Material	P	Steels	●	●	●									Cutting Conditions (Guide) : ● : Stable Cutting ● : General Cutting ✖ : Unstable Cutting				
	M	Stainless Steels	●			●	✖								Honing : E : Round			
Shape	K	Cast Irons																
	S	Heat Resistant Alloys, Titanium Alloys																
	H	Hardened Steels																
Order Number	Class	Honing	Coated								Dimensions (mm)				Geometry			
			MC7020	MP6120	MP6130	MP7130	MP7140	MP9120	MP9130	VP15TF	VP30RT	IC	S	BS		RE		
	JOMU090512ZZER-L	M	E	●	●	●	●	●	●	●	●	●	●	9.525	4.73	0.88	1.2	 Right hand insert only.
	JOMU090512ZZER-M	M	E	●	●	●	●	●	●	●	●	●	●	9.525	4.75	0.88	1.2	
	JOMU090512ZZER-R	M	E	●	●									9.525	4.83	0.88	1.2	

● = NEW

■Cutter Diameter and Flat Surface Milling

The maximum cutting diameter (DCX) shown in the WJX items table is not the same as the possible dimensions for plane cutting. The possible dimensions for plane cutting are given as the cutting axle DC value. Please note that this is smaller than the DCX value.

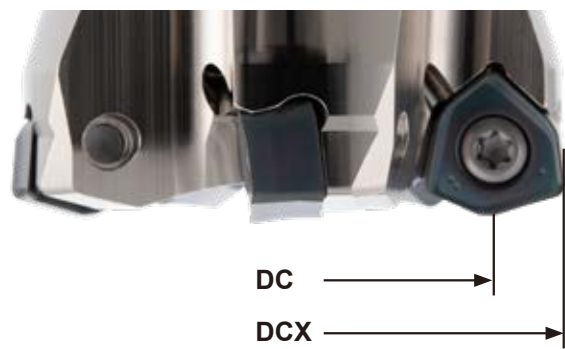

RECOMMENDED CUTTING CONDITIONS

■ Correction Value According to Overhang Length

Multiply the recommended cutting conditions by the correction factor x overhang length.

Type	Cutting Dia. Max. DCX	Overhang Length	Correction Value According		
			Cutting Speed Vc (m/min)	Depth of Cut ap	Feed fz(mm/t.)
Shank Type Screw-in Type	25—40	< 2.5×DCON	100%	100%	100%
		3.0×DCON	90%	100%	90%
		4.0×DCON	85%	90%	85%
		5.0×DCON	80%	85%	80%
		7.5×DCON	70%	75%	75%
Arbor Type	40—66	< 2.5×DCX	100%	100%	100%
		3.0×DCX	85%	100%	90%
		4.0×DCX	80%	80%	80%
		5.0×DCX	75%	75%	60%
		6.0×DCX	70%	70%	40%

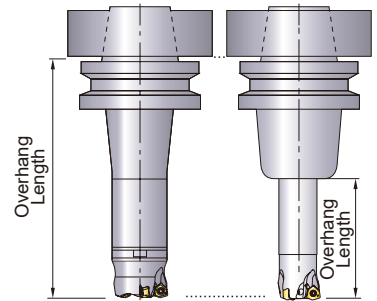

K

ROTATING TOOLS

DCON=Connection Dia.

■ Cutting Speed (Dry Cutting)

Work Material	Properties	Cutting Speed Vc (m/min)				
P		MP6130	MP6120	VP15TF	MC7020	VP30RT
Mild Steel	≤180HB	160 (110—200)	170 (120—220)	170 (120—220)	230 (180—280)	140 (100—180)
Carbon Steel Alloy Steel	180—280HB	140 (90—200)	160 (100—220)	160 (100—220)	220 (170—270)	120 (80—170)
Carbon Steel Alloy Steel	280—350HB	140 (90—200)	160 (100—220)	160 (100—220)	220 (170—270)	120 (80—170)
Alloy Tool Steel	≤350HB (Annealing)	140 (90—200)	160 (100—220)	160 (100—220)	220 (170—270)	120 (80—170)
Pre-hardened Steel	35—45HRC	100 (60—140)	120 (80—160)	120 (80—160)	—	90 (50—130)
M		MP7130	MP7140	MC7020	VP30RT	
Austenitic Stainless Steel	≤200HB	160 (130—200)	150 (120—180)	220 (170—270)	150 (120—180)	
Austenitic Stainless Steel	>200HB	140 (100—200)	130 (80—180)	190 (140—240)	130 (80—180)	
Ferritic and Martensitic Stainless Steel	≤200HB	150 (100—200)	130 (80—180)	220 (170—270)	130 (80—180)	
Duplex Stainless Steel	≤280HB	130 (80—180)	110 (60—160)	180 (130—230)	110 (60—160)	
Precipitation Hardening Stainless Steel	<450HB	110 (60—160)	90 (50—130)	170 (120—220)	90 (50—130)	
K		VP15TF				
Gray Cast Iron	≤350MPa	180 (140—220)				
Ductile Cast Iron	≤450MPa	160 (120—210)				
Ductile Cast Iron	≤800MPa	130 (90—170)				
S		MP9130	MP9120	VP15TF		
Titanium Alloy	—	40 (30—60)	50 (30—65)	50 (30—65)		
Heat Resistant Alloy	—	30 (20—40)	40 (20—50)	40 (20—50)		
H		VP15TF				
Hardened Steel	40—55HRC	70 (40—100)				

Note 1) To discharge chips effectively, use an air blow when machining. When the air blow is less effective at discharging chips, we recommend wet cutting.

Note 2) When wet cutting, tool life may become shorter than dry cutting. When carrying out wet cutting for the applications recommended with dry cutting, reduce the cutting speed by 25%.

Note 3) When large vibration occurs, reduce the cutting conditions.

Note 4) For interrupted cutting, reduce the cutting speed and feed rate by 20%.

ROTATING TOOLS

RECOMMENDED CUTTING CONDITIONS

■ Depth of Cut / Feed per Tooth

(mm)

Work Material	Properties	Depth of Cut ap	Breaker	Cutting Dia. Max. DCX=25,28(Z=2)	Cutting Dia. Max. DCX=25,28(Z=3)	Cutting Dia. Max. DCX=32-	Cutting Mode			
				Feed fz(mm/t.)	Feed fz(mm/t.)	Feed fz(mm/t.)				
P Mild Steel	Hardness ≤180HB	≤0.5	M,R	1.3(0.4-2.0)	1.3(0.4-2.0)	1.5(0.5-2.0)	Dry			
			L	1.2(0.4-1.6)	1.2(0.4-1.6)	1.2(0.4-1.6)				
		≤1.0	M,R	1.0(0.3-1.3)	0.8(0.3-1.0)	1.2(0.4-1.5)				
			L	0.8(0.3-1.2)	0.8(0.3-1.0)	0.8(0.3-1.2)				
		≤1.5	M,R	0.6(0.3-1.0)	-	0.8(0.4-1.2)				
	Carbon Steel Alloy Steel	Hardness 180-280HB	≤0.5	M,R	1.3(0.4-1.7)	1.3(0.4-1.7)	1.5(0.4-2.0)	Dry		
				L	1.2(0.3-1.5)	1.2(0.3-1.5)	1.2(0.3-1.5)			
			≤1.0	M,R	0.8(0.3-1.0)	0.7(0.3-0.9)	1.0(0.3-1.3)			
				L	0.7(0.2-1.0)	0.7(0.2-0.9)	0.7(0.2-1.0)			
			≤1.5	M,R	0.5(0.3-0.7)	-	0.7(0.3-1.0)			
Carbon Steel Alloy Steel Alloy Tool Steel	Hardness 280-350HB ≤350HB (Annealing)	≤0.5	M,R	1.3(0.4-1.7)	1.3(0.4-1.7)	1.5(0.4-2.0)	Dry			
			L	1.2(0.3-1.5)	1.2(0.3-1.5)	1.2(0.3-1.5)				
		≤1.0	M,R	0.8(0.3-1.0)	0.7(0.3-0.9)	1.0(0.3-1.3)				
			L	0.7(0.2-1.0)	0.7(0.2-0.9)	0.7(0.2-1.0)				
		≤1.5	M,R	0.5(0.3-0.7)	-	0.7(0.3-1.0)				
Pre-hardened Steel	Hardness 35-45HRC	≤0.5	M,R	1.0(0.3-1.3)	1.0(0.3-1.3)	1.2(0.3-1.5)	Dry			
			L	0.8(0.3-1.2)	0.8(0.3-1.2)	0.8(0.3-1.2)				
		≤1.0	M,R	0.6(0.2-0.8)	0.6(0.2-0.8)	0.8(0.2-1.0)				
			L	0.5(0.2-0.8)	0.5(0.2-0.8)	0.5(0.2-0.8)				
		≤1.5	M,R	0.5(0.3-0.7)	-	0.7(0.3-1.0)				
M Austenitic Stainless Steel	-	≤0.5	L	0.8(0.3-1.0)	0.8(0.3-1.0)	0.8(0.3-1.0)	Dry			
			M	1.0(0.4-1.2)	1.0(0.4-1.2)	1.0(0.4-1.2)				
		≤1.0	L	0.6(0.2-0.8)	0.6(0.2-0.8)	0.6(0.2-0.8)				
			M	0.8(0.3-1.0)	0.8(0.3-1.0)	0.8(0.3-1.0)				
		≤0.5	L	0.8(0.3-1.0)	0.8(0.3-1.0)	0.8(0.3-1.0)		Dry		
			M	1.0(0.4-1.2)	1.0(0.4-1.2)	1.0(0.4-1.2)				
	≤1.0	L	0.6(0.2-0.8)	0.6(0.2-0.8)	0.6(0.2-0.8)					
		M	0.8(0.3-1.0)	0.8(0.3-1.0)	0.8(0.3-1.0)					
	Duplex Stainless Steel	Hardness ≤280HB	≤0.5	L	0.6(0.3-0.8)	0.6(0.3-0.8)	0.6(0.3-0.8)		Dry	
				M	0.7(0.3-1.0)	0.7(0.3-1.0)	0.7(0.3-1.0)			
			≤1.0	L	0.5(0.2-0.7)	0.5(0.2-0.7)	0.5(0.2-0.7)			
				M	0.6(0.3-0.7)	0.6(0.3-0.7)	0.6(0.3-0.7)			
≤0.5			L	0.6(0.3-0.8)	0.6(0.3-0.8)	0.6(0.3-0.8)	Dry			
			M	0.7(0.3-1.0)	0.7(0.3-1.0)	0.7(0.3-1.0)				
≤1.0	L	0.5(0.2-0.7)	0.5(0.2-0.7)	0.5(0.2-0.7)						
	M	0.6(0.3-0.7)	0.6(0.3-0.7)	0.6(0.3-0.7)						
Precipitation Hardening Stainless Steel	Hardness <450HB	≤0.5	L	0.6(0.3-0.8)	0.6(0.3-0.8)	0.6(0.3-0.8)		Dry		
			M	0.7(0.3-1.0)	0.7(0.3-1.0)	0.7(0.3-1.0)				
		≤1.0	L	0.5(0.2-0.7)	0.5(0.2-0.7)	0.5(0.2-0.7)				
			M	0.6(0.3-0.7)	0.6(0.3-0.7)	0.6(0.3-0.7)				
		K Gray Cast Iron	Tensile Strength ≤350MPa	≤0.5	M,R	1.3(0.4-2.0)	1.3(0.4-2.0)		1.5(0.5-2.0)	Dry
					L	1.2(0.4-1.6)	1.2(0.4-1.6)		1.2(0.4-1.6)	
≤1.0	M,R			1.0(0.3-1.3)	0.8(0.3-1.0)	1.2(0.4-1.5)				
	L			1.0(0.3-1.3)	0.8(0.3-1.0)	1.0(0.3-1.3)				
≤1.5	M,R			0.6(0.3-1.0)	-	0.8(0.4-1.2)				
Ductile Cast Iron	Tensile Strength ≤450MPa	≤0.5	M,R	1.3(0.4-1.7)	1.3(0.4-1.7)	1.5(0.4-2.0)	Dry			
			L	1.0(0.3-1.3)	1.0(0.3-1.3)	1.0(0.3-1.3)				
		≤1.0	M,R	0.8(0.3-1.0)	0.7(0.3-0.9)	1.0(0.3-1.3)				
			L	0.8(0.2-1.0)	0.7(0.2-0.9)	0.8(0.2-1.2)				
		≤1.5	M,R	0.5(0.3-0.7)	-	0.7(0.3-1.0)				
Ductile Cast Iron	Tensile Strength ≤800MPa	≤0.5	M,R	1.0(0.2-1.5)	1.0(0.2-1.5)	1.3(0.3-1.7)	Dry			
			L	0.8(0.3-1.2)	0.8(0.3-1.2)	0.8(0.3-1.2)				
		≤1.0	M,R	0.8(0.2-1.0)	0.6(0.2-0.8)	1.0(0.3-1.2)				
			L	0.5(0.2-0.8)	0.5(0.2-0.8)	0.5(0.2-0.8)				
		≤0.5	L	0.3(0.2-0.6)	0.3(0.2-0.6)	0.3(0.2-0.6)		Wet		
			L	0.3(0.2-0.4)	0.3(0.2-0.4)	0.3(0.2-0.4)				
S Titanium Alloy	-	≤0.5	L,M,R	0.8(0.3-1.2)	0.8(0.3-1.2)	0.8(0.3-1.2)	Wet			
			L,M,R	0.7(0.3-1.0)	0.7(0.3-1.0)	0.7(0.3-1.0)				
		≤1.0	L,M,R	0.7(0.3-1.0)	0.7(0.3-1.0)	0.7(0.3-1.0)				
H Hardened Steel	Hardness 40-55HRC	≤0.5	R,M	0.6(0.3-1.0)	0.6(0.3-1.0)	0.6(0.3-1.0)	Dry			
			R,M	0.5(0.3-0.8)	0.4(0.3-0.6)	0.5(0.3-0.8)				
		≤1.0	R,M	0.5(0.3-0.8)	0.4(0.3-0.6)	0.5(0.3-0.8)				

Note 1) To discharge chips effectively, use an air blow when machining. When the air blow is less effective at discharging chips, we recommend wet cutting.

Note 2) When large vibration occurs, reduce the cutting conditions.

Note 3) For interrupted cutting, reduce the cutting speed and feed rate by 20%.

Note 4) If ap is set at 2mm or more, avoid machining on the walls or ramping.

MAXIMUM CAPACITIES BY MODE

■ Ramping

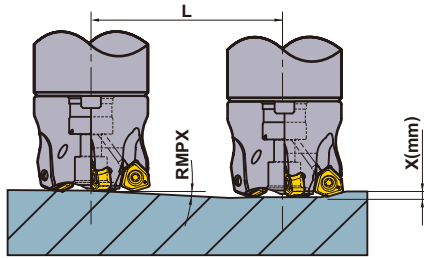

■ Helical Milling

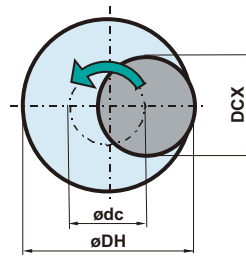

● How to derive a locus of the centre of the tool.

$$\text{ødc} = \text{øDH} - \text{DCX}$$

ødc = Locus of the Centre of the Tool
 øDH = Desired Hole Diameter
 DCX = Cutting Diameter Maximum

Tool Holder Type	DCX (mm)	DC (mm)	APMX (mm)	Ramping		Helical Milling (Blind Hole, Flat Bottom)		Helical Milling (Through Hole)		AZ (mm)
				RMPX	L (mm) Required Distance for X mm Depth	DH (mm)		DH (mm)	P max. (mm)	
					x = 1 (mm)	Min.	Max.	Min.		
WJX09R25	25	14.0	1.2	4.7°	12.2	38	47	34	1.2	0.8
WJX09R28	28	16.9	1.2	5.6°	10.2	44	53	38	1.2	1.2
WJX09R32	32	20.9	1.2	4.2°	13.7	52	61	46	1.2	1.2
WJX09R35	35	23.8	1.2	3.6°	15.9	58	67	52	1.2	1.2
WJX09R40	40	28.8	1.2	2.9°	19.8	68	77	61	1.2	1.2
WJX09-040	40	28.8	1.2	2.9°	19.8	68	77	61	1.2	1.2
WJX09-050	50	38.8	1.2	2.0°	28.7	88	97	81	1.2	1.2
WJX09-052	52	40.8	1.2	1.9°	30.2	92	101	85	1.2	1.2
WJX09-063	63	51.8	1.2	1.4°	41.0	114	123	107	1.2	1.2
WJX09-066	66	54.8	1.2	1.4°	41.0	120	129	113	1.2	1.2

DCX = Cutting Dia. Max.
APMX = Depth of Cut Max.

DC = Cutting Dia.
RMPX = Ramping Angle Max.

DH = Desired Hole Dia.
AZ = Plunge Depth Max.

Note 1) When ramping and helical milling, it is recommended to reduce the feed per tooth.
 Note 2) When ramping, helical milling and drilling, long continuous chips may be dispersed.

<Helical Milling>

To obtain a flat bottom surface when helical milling, it requires to remove "the uncut part" in the centre of the work material at a final pass. When helical milling, make sure that the depth of cut per helical pass doesn't exceed the maximum depth of cut (APMX).

<Drilling>

When drilling, set the axial feed per revolution at 0.2mm/rev or less.

OPERATIONAL GUIDANCE

■ Depth of Cut

Refer to the following table for the maximum depth of cut of the WJX. The straight cutting edge extending to the maximum depth of cut (APMX) allows for stable machining even at high depths of cut. For face milling, lowering the feed rate will allow the APMX value to be exceeded, up to depths of cut shown in the following table (when using the corner R). For details on the feed rate, refer to the recommended cutting conditions on page K076.

K
ROTATING TOOLS

	WJX09
High feed and multi-function machining (APMX)	ap=1.2mm
Low feed and Face machining	ap=1.5mm

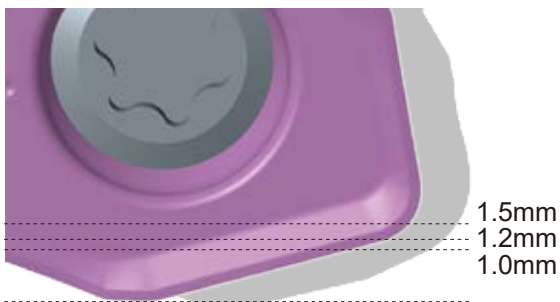

WJX09 Conventional Size 09

■ Remaining Stock

For CAM, use CAD data (from online catalogs), or use a definition as a radius milling cutter with reference to the following table. The approximate radius RE, remaining stock K1, and over cutting amount K2 are as shown in the following table.

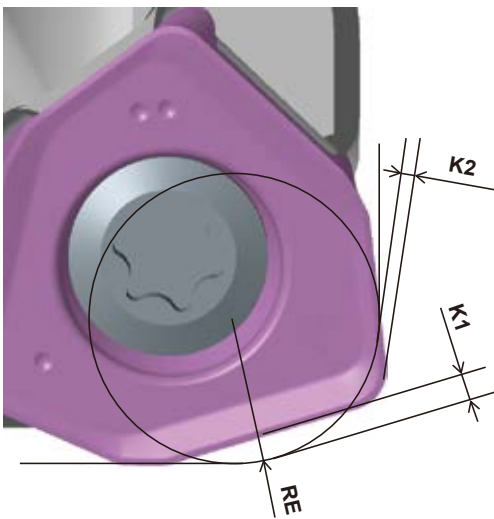

WJX09

RE (mm)	Remaining Stock K1	Cutting Amount K2
R2.0 (Recommendation)	0.93	0.00
R2.3	0.86	0.00
R3.0	0.70	0.13

Depth of Cut ap (mm)	Remaining Stock H
0.5	0.02
1.0	0.07
1.5	-

MULTI-FUNCTIONAL MILLING



WJX14

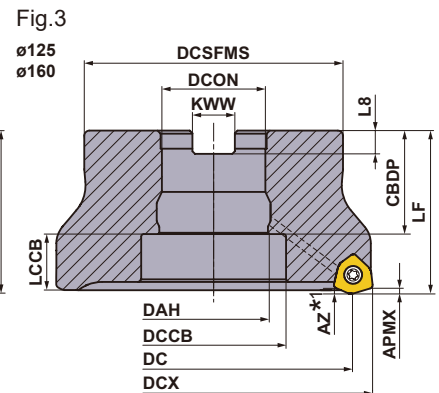
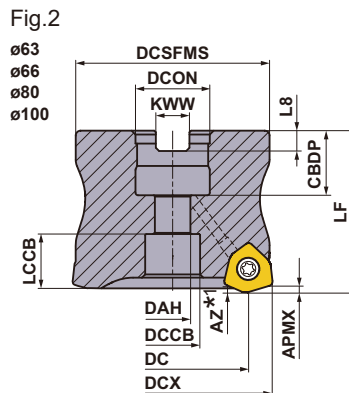
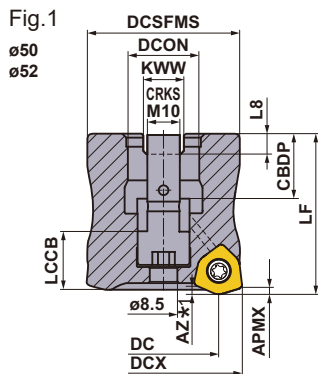

Right hand tool holder only.

DCON (mm)	Set Bolt	Geometry	
		①	②
φ22	HSC10030H	①	②
φ27	HSC12035H		
φ32	HSC16040H	②	
φ40	MBA20040H MBA24045H		

ARBOR TYPE

GAMP: -7°, -10° GAMF: -10°
With Coolant Hole

Note 1) The tools with cutting diameter maximum DCX = 50mm and 52mm has a built in set bolt. Please use 7mm Allen wrench to tighten / loosen the set bolt.

DCX (mm)	Order Number	Stock R	Number of Teeth	Dimensions (mm)			WT *2 (kg)	APMX (mm)	RPMX (min ⁻¹)	Fig.	Insert Type
				DC	LF	DCON					
50	WJX14-050A03AR	★	3	34.5	50	22	0.4	2	5000	1	JOMU1407
50	WJX14-050A04AR	●	4	34.5	50	22	0.4	2	5000	1	JOMU1407
52	WJX14-052A04AR	●	4	36.5	50	22	0.4	2	5000	1	JOMU1407
63	WJX14-063A04AR	●	4	47.5	50	22	0.7	2	18200	2	JOMU1407
63	WJX14-063A05AR	★	5	47.5	50	22	0.7	2	18200	2	JOMU1407
63	WJX14-063X05AR	●	5	47.5	50	27	0.6	2	18200	2	JOMU1407
66	WJX14-066X05AR	●	5	50.4	50	27	0.7	2	17700	2	JOMU1407
80	WJX14-080A05AR	●	5	64.4	50	27	1.2	2	15600	2	JOMU1407
80	WJX14-080A06AR	●	6	64.4	50	27	1.2	2	15600	2	JOMU1407
100	WJX14-100A06AR	★	6	84.4	63	32	2.5	2	13500	2	JOMU1407
100	WJX14-100A07AR	★	7	84.4	63	32	2.5	2	13500	2	JOMU1407
125	WJX14-125B07AR	★	7	109.4	63	40	3.2	2	11600	3	JOMU1407
125	WJX14-125B09AR	★	9	109.4	63	40	3.1	2	11600	3	JOMU1407
160	WJX14-160B09AR	★	9	144.4	63	40	4.9	2	9900	3	JOMU1407

*1 Refer to page K084, for the maximum drilling depth (AZ).

*2 WT : Tool Weight

Note 1) The maximum allowable spindle speeds (RPMX) are set to ensure tool and insert stability.

Note 2) Tools with cutting diameter DCX = 50 mm and 52 mm have a built-in set bolt that cannot be replaced.

Therefore, do not disassemble the milling cutter.

Note 3) When using the tool at high spindle speeds, ensure that the tool and arbor are correctly balanced.

SPARE PARTS

Tool Holder Type	* (Refer to page K084)		
	Clamp Screw	Wrench (Insert)	Anti-seize Lubricant
WJX14	TS5R	TKY20T	MK1KS

* Clamp Torque (N · m) : TS5R = 5.0

● : Inventory maintained. ★ : Inventory maintained in Japan.

MOUNTING DIMENSION	> K080
SPARE PARTS	> N001
TECHNICAL DATA	> P001

ROTATING TOOLS

ROTATING TOOLS

MOUNTING DIMENSIONS

DCX (mm)	Order Number	Dimensions (mm)								Fig.
		DCON	CBDP	DAH	DCCB	LCCB	DCSFMS	KWW	L8	
50	WJX14-050A03AR	22	20	—	—	18.3	47	10.4	6.3	1
50	WJX14-050A04AR	22	20	—	—	18.3	47	10.4	6.3	1
52	WJX14-052A04AR	22	20	—	—	18.3	47	10.4	6.3	1
63	WJX14-063A04AR	22	20	11	17	16.7	60	10.4	6.3	2
63	WJX14-063A05AR	22	20	11	17	16.7	60	10.4	6.3	2
63	WJX14-063X05AR	27	23	13	20	15.7	60	12.4	7	2
66	WJX14-066X05AR	27	23	13	20	15.7	60	12.4	7	2
80	WJX14-080A05AR	27	23	13	20	15.7	76	12.4	7	2
80	WJX14-080A06AR	27	23	13	20	15.7	76	12.4	7	2
100	WJX14-100A06AR	32	26	17	26	25.7	96	14.4	8	2
100	WJX14-100A07AR	32	26	17	26	25.7	96	14.4	8	2
125	WJX14-125B07AR	40	40	42	56	21.7	100	16.4	9	3
125	WJX14-125B09AR	40	40	42	56	21.7	100	16.4	9	3
160	WJX14-160B09AR	40	40	42	56	21.7	100	16.4	9	3

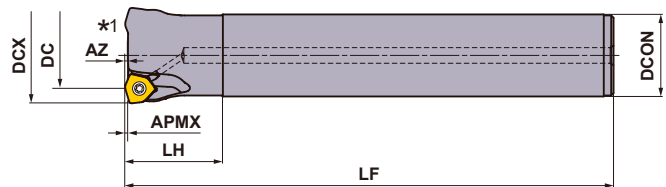

Right hand tool holder only.

SHANK TYPE

With Coolant Hole



DCX (mm)	Order Number	Stock R	Number of Teeth	Dimensions (mm)				APMX (mm)	RPMX (min ⁻¹)	Insert Type
				DC	LF	LH	DCON			
50	WJX14R5003SA42S	★	3	34.5	150	50	42	2	21200	JOMU1407
50	WJX14R5003SA42L	★	3	34.5	250	50	42	2	21200	JOMU1407

*1 Refer to page K084, for the maximum drilling depth (AZ).

Note 1) The maximum allowable spindle speeds (RPMX) are set to ensure tool and insert stability.

Note 2) When using the tool at high spindle speeds, ensure that the tool and arbor are correctly balanced.

SPARE PARTS

Tool Holder Type			
	Clamp Screw	Wrench (Insert)	Anti-seize Lubricant
WJX14	TS5R	TKY20D	MK1KS

* Clamp Torque (N • m) : TS5R = 5.0

● : Inventory maintained. ★ : Inventory maintained in Japan.
(10 inserts in one case)

INSERTS

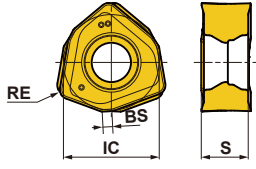
Work Material	P	Steels	●	●	✦											Cutting Conditions (Guide) : ● : Stable Cutting ● : General Cutting ✦ : Unstable Cutting Honing : E : Round	
	M	Stainless Steels	●			●	✦										
K	Cast Irons																
S	Heat Resistant Alloys, Titanium Alloys																
H	Hardened Steels																
Shape	Order Number	Class	Honing	Coated								Dimensions (mm)				Geometry	
				MC7020	MP6120	MP6130	MP7130	MP7140	MP9120	MP9130	VP15TF	VP30RT	IC	S	BS		RE
	NEW JOMU140715ZZER-L	M	E	●	●	●	●	●	●	●	★	★	14	6.58	1.3	1.5	 Right hand insert only.
	JOMU140715ZZER-M	M	E	●	●	●	●	●	●	●	★	★	14	6.63	1.3	1.5	
	NEW JOMU140715ZZER-R	M	E	●	●	●						●	●	14	6.75	1.3	

● = **NEW**

K
ROTATING TOOLS

ROTATING TOOLS

RECOMMENDED CUTTING CONDITIONS

Correction Value According to Overhang Length

Multiply the recommended cutting conditions by the correction factor x overhang length.

Type	Cutting Dia. Max. DCX	Overhang Length	Correction Value According		
			Cutting Speed Vc (m/min)	Depth of Cut ap	Feed fz(mm/t.)
Shank Type	50	< 2.5×DCON	100%	100%	100%
		3.0×DCON	90%	100%	90%
		4.0×DCON	80%	80%	90%
Arbor Type	50-80	< 2.5×DCX	100%	100%	100%
		3.0×DCX	85%	100%	90%
		4.0×DCX	80%	80%	80%
		5.0×DCX	75%	75%	60%
		6.0×DCX	70%	70%	40%
		≥ 100	200	100%	100%
	300	85%	100%	90%	
	400	80%	80%	80%	

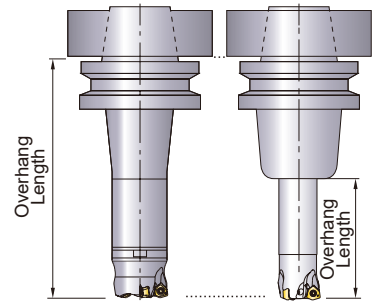

DCON=Connection Dia.

Cutting Speed (Dry Cutting)

Work Material	Properties	Cutting Speed Vc (m/min)				
P		MP6130	MP6120	MC7020	VP15TF	VP30RT
Mild Steel	≤180HB	140 (90-180)	150 (100-200)	220 (170-270)	150 (100-200)	120 (80-160)
Carbon Steel Alloy Steel	180-280HB	120 (70-180)	140 (80-200)	200 (150-250)	140 (80-200)	100 (60-150)
Carbon Steel Alloy Steel	280-350HB	120 (70-180)	140 (80-200)	200 (150-250)	140 (80-200)	100 (60-150)
Alloy Tool Steel	≤350HB (Annealing)	120 (70-180)	140 (80-200)	200 (150-250)	140 (80-200)	100 (60-150)
Pre-hardened Steel	35-45HRC	90 (50-130)	110 (70-150)	-	110 (70-150)	80 (40-120)
M		MP7130	MP7140	MC7020	VP30RT	
Austenitic Stainless Steel	≤200HB	160 (130-200)	150 (120-180)	220 (170-270)	150 (120-180)	
Austenitic Stainless Steel	>200HB	140 (100-200)	130 (80-180)	190 (140-240)	130 (80-180)	
Ferritic and Martensitic Stainless Steel	≤200HB	150 (100-200)	130 (80-180)	220 (170-270)	130 (80-180)	
Duplex Stainless Steel	≤280HB	130 (80-180)	110 (60-160)	180 (130-230)	110 (60-160)	
Precipitation Hardening Stainless Steel	<450HB	110 (60-160)	90 (50-130)	170 (120-220)	90 (50-130)	
K		VP15TF				
Gray Cast Iron	≤350MPa	160 (120-200)				
Ductile Cast Iron	≤450MPa	150 (100-200)				
Ductile Cast Iron	≤800MPa	120 (80-160)				
S		MP9130	MP9120	VP15TF		
Titanium Alloy	-	40 (30-60)	50 (30-65)	50 (30-65)		
Heat Resistant Alloy	-	30 (20-40)	40 (20-50)	40 (20-50)		
H		VP15TF				
Hardened Steel	40-55HRC	70 (40-100)				

Note 1) To discharge chips effectively, use an air blow when machining. When the air blow is less effective at discharging chips, we recommend wet cutting.

Note 2) When wet cutting, tool life may become shorter than dry cutting. When carrying out wet cutting for the applications recommended with dry cutting, reduce the cutting speed by 25%.

Note 3) When large vibration occurs, reduce the cutting conditions.

Note 4) For interrupted cutting, reduce the cutting speed and feed rate by 20%.

■ Depth of Cut / Feed per Tooth

(mm)

Work Material	Properties	Depth of Cut ap	Breaker	Cutting Dia. Max. DCX=50, 52	Cutting Dia. Max. DCX≥63	Cutting Mode			
				Feed fz(mm/t.)	Feed fz(mm/t.)				
P	Mild Steel	≤1.0	M,R	1.5(0.6-2.5)	1.7(0.6-2.8)	Dry			
			L	1.2(0.4-2.0)	1.2(0.4-2.0)				
		≤1.5	M,R	1.3(0.6-2.0)	1.5(0.6-2.5)				
			L	1.0(0.4-1.8)	1.0(0.4-1.8)				
		≤2.0	M,R	1.2(0.6-2.0)	1.3(0.6-2.5)				
			L	0.8(0.4-1.7)	0.8(0.4-1.7)				
		≤2.5	M,R	0.8(0.3-1.5)	1.0(0.3-1.6)				
		≤3.0	M,R	0.4(0.2-1.0)	0.5(0.2-1.2)				
		Carbon Steel Alloy Steel	Hardness 180-280HB	≤1.0	M,R		1.5(0.5-2.0)	1.7(0.5-2.5)	Dry
					L		1.0(0.3-1.7)	1.0(0.3-1.7)	
	≤1.5			M,R	1.2(0.5-1.7)	1.3(0.5-2.5)			
				L	0.8(0.3-1.5)	0.8(0.3-1.5)			
	≤2.0			M,R	1.0(0.5-1.5)	1.2(0.5-2.0)			
				L	0.7(0.3-1.2)	0.7(0.3-1.2)			
	Carbon Steel Alloy Steel Alloy Tool Steel	Hardness 280-350HB ≤350HB (Annealing)	≤1.0	M,R	1.5(0.5-2.0)	1.7(0.5-2.5)	Dry		
				L	1.0(0.3-1.7)	1.0(0.3-1.7)			
			≤1.5	M,R	1.2(0.5-1.7)	1.3(0.5-2.2)			
				L	0.8(0.3-1.5)	0.8(0.3-1.5)			
			≤2.0	M,R	1.0(0.5-1.5)	1.2(0.5-2.0)			
				L	0.7(0.3-1.2)	0.7(0.3-1.2)			
Pre-hardened Steel	Hardness 35-45HRC	≤1.0	M,R	1.3(0.4-1.7)	1.5(0.4-2.0)	Dry			
			L	0.7(0.3-1.2)	0.7(0.3-1.2)				
		≤1.5	M,R	1.0(0.4-1.5)	1.2(0.4-1.5)				
			L	0.6(0.3-1.0)	0.6(0.3-1.0)				
		≤2.0	M,R	0.8(0.4-1.2)	1.0(0.4-1.3)				
			L	0.5(0.3-0.8)	0.5(0.3-0.8)				
M	Austenitic Stainless Steel	≤1.0	L	0.8(0.3-1.2)	0.8(0.3-1.2)	Dry			
			M	1.0(0.5-1.2)	1.0(0.5-1.2)				
		≤1.5	L	0.8(0.3-1.0)	0.8(0.3-1.0)				
			M	1.0(0.5-1.0)	1.0(0.5-1.0)				
	Ferritic and Martensitic Stainless Steel	Hardness ≤200HB	≤1.0	L	0.8(0.3-1.2)	0.8(0.3-1.2)	Dry		
				M	1.0(0.5-1.2)	1.0(0.5-1.2)			
			≤1.5	L	0.8(0.3-1.0)	0.8(0.3-1.0)			
				M	1.0(0.5-1.0)	1.0(0.5-1.0)			
	Duplex Stainless Steel	Hardness ≤280HB	≤1.0	L	0.6(0.3-1.0)	0.6(0.3-1.0)	Dry		
				M	0.8(0.4-1.0)	0.8(0.4-1.0)			
			≤1.5	L	0.6(0.3-0.8)	0.6(0.3-0.8)			
				M	0.8(0.4-0.8)	0.8(0.4-0.8)			
	Precipitation Hardening Stainless Steel	Hardness <450HB	≤1	L	0.6(0.3-1.0)	0.6(0.3-1.0)	Dry		
				M	0.8(0.4-1.0)	0.8(0.4-1.0)			
≤1.5			L	0.6(0.3-0.8)	0.6(0.3-0.8)				
			M	0.8(0.4-0.8)	0.8(0.4-0.8)				
K	Gray Cast Iron	≤1	M,R	1.7(0.6-2.5)	1.8(0.6-2.8)	Dry			
			L	1.3(0.4-2.0)	1.3(0.4-2.0)				
		≤1.5	M,R	1.5(0.6-2.0)	1.7(0.6-2.5)				
			L	1.2(0.4-1.8)	1.2(0.4-1.8)				
		≤2	M,R	1.3(0.6-2.0)	1.5(0.6-2.5)				
			L	1.0(0.4-1.5)	1.0(0.4-1.5)				
	Ductile Cast Iron	Tensile Strength ≤450MPa	≤1	M,R	1.5(0.5-2.0)	1.7(0.5-2.5)	Dry		
				L	1.2(0.3-2.0)	1.2(0.3-2.0)			
			≤1.5	M,R	1.3(0.5-1.8)	1.5(0.5-2.0)			
				L	1.0(0.3-1.7)	1.0(0.3-1.7)			
			≤2	M,R	1.2(0.5-1.8)	1.3(0.5-2.0)			
				L	0.8(0.3-1.5)	0.8(0.3-1.5)			
	Ductile Cast Iron	Tensile Strength ≤800MPa	≤1	M,R	1.3(0.4-1.8)	1.5(0.4-2.0)	Dry		
				L	1.0(0.3-1.7)	1.0(0.3-1.7)			
			≤1.5	M,R	1.2(0.4-1.5)	1.3(0.4-1.8)			
				L	0.8(0.3-1.5)	0.8(0.3-1.5)			
			≤2	M,R	1.0(0.4-1.5)	1.2(0.4-1.8)			
				L	0.7(0.3-1.2)	0.7(0.3-1.2)			
S	Titanium Alloy	≤1	L	0.3(0.2-0.6)	0.3(0.2-0.6)	Wet			
		≤1.5	L	0.3(0.2-0.5)	0.3(0.2-0.5)				
		≤2	L	0.3(0.2-0.4)	0.3(0.2-0.4)				
	Heat Resistant Alloy	-	≤1	L,M,R	1.0(0.3-1.3)	1.0(0.3-1.3)	Wet		
			≤1.5	L,M,R	0.8(0.3-1.2)	0.8(0.3-1.2)			
			≤2	L,M,R	0.7(0.3-1.2)	0.7(0.3-1.2)			
H	Hardened Steel	≤1	R,M	0.8(0.3-1.2)	0.8(0.3-1.2)	Dry			
		≤1.5	R,M	0.6(0.3-1.0)	0.6(0.3-1.0)				
		≤2	R,M	0.5(0.3-0.8)	0.5(0.3-0.8)				

K
ROTATING TOOLS

Note 1) To discharge chips effectively, use an air blow when machining. When the air blow is less effective at discharging chips, we recommend wet cutting.

Note 2) When large vibration occurs, reduce the cutting conditions.

Note 3) For interrupted cutting, reduce the cutting speed and feed rate by 20%.

Note 4) If ap is set at 2mm or more, avoid machining on the walls or ramping.

MAXIMUM CAPACITIES BY MODE

■ Ramping

■ Helical Milling

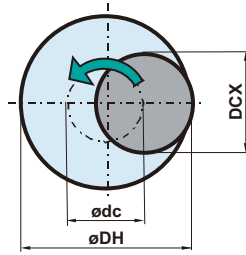
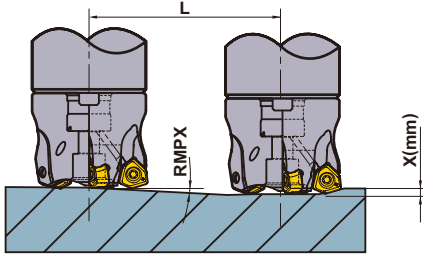

● How to derive a locus of the centre of the tool.

$$\text{ødc} = \text{øDH} - \text{DCX}$$

Locus of the Centre of the Tool
Desired Hole Diameter
Cutting Diameter Maximum

Tool Holder Type	DCX	DC	APMX	Ramping		Helical Milling (Blind Hole, Flat Bottom)		Helical Milling (Through Hole)	AZ	
				RMPX	L (mm) Required Distance for X mm Depth		DH			DH
					x=1	x=2	Min.	Max.		Min.
WJX14R50	50	34.5	2	4.4°	13.0	26.0	82	97	73	2.1
WJX14-050	50	34.5	2	4.4°	13.0	26.0	82	97	73	2.1
WJX14-052	52	36.5	2	4.1°	14.0	28.0	86	101	77	2.1
WJX14-063	63	47.5	2	3.0°	19.1	38.2	108	123	99	2.1
WJX14-066	66	50.4	2	2.8°	20.5	40.9	114	129	105	2.1
WJX14-080	80	64.4	2	2.1°	27.3	54.6	142	157	133	2.1
WJX14-100	100	84.4	2	1.5°	38.2	76.4	182	197	173	2.1
WJX14-125	125	109.4	2	1.2°	47.8	95.5	232	247	223	2.1
WJX14-160	160	144.4	2	0.8°	71.7	143.3	302	317	293	2.1

DCX = Cutting Dia. Max.

APMX = Depth of Cut Max.

DC = Cutting Dia.

RMPX = Ramping Angle Max.

DH = Desired Hole Dia.

AZ = Plunge Depth Max.

Note 1) When ramping and helical milling, it is recommended to reduce the feed per tooth.

Note 2) When ramping, helical milling and drilling, long continuous chips may be scattered so please be careful.

<Helical Milling>

To obtain a flat bottom surface when helical milling, it requires to remove "the uncut part" in the centre of the work material with a final pass.

When helical milling, make sure that the depth of cut per helical pass doesn't exceed the maximum depth of cut (APMX).

<Drilling>

When drilling, set the axial feed per revolution at 0.2mm/rev or less.

OPERATIONAL GUIDANCE

■ Depth of Cut

Refer to the following table for the maximum depth of cut of the WJX. The straight cutting edge extending to the maximum depth of cut (APMX) allows for stable machining even at high depths of cut. For face milling, lowering the feed rate will allow the APMX value to be exceeded, up to depths of cut shown in the following table (when using the corner R). For details on the feed rate, refer to the recommended cutting conditions on page K083.

WJX14	
High feed and multi-function machining (APMX)	ap=2.0 mm
Low feed and Face machining	ap=3.0 mm

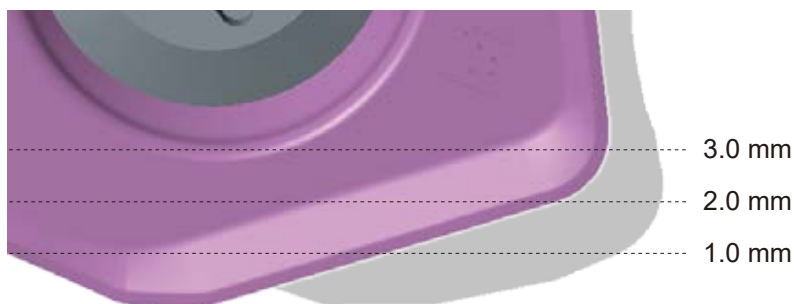

WJX14 Conventional Size 14

■ Remaining Stock

For CAM, use CAD data (from online catalogues), use as a radius milling cutter with reference to the following table. The approximate radius RE, remaining stock K1, and over cut amount K2 are as shown in the following table.

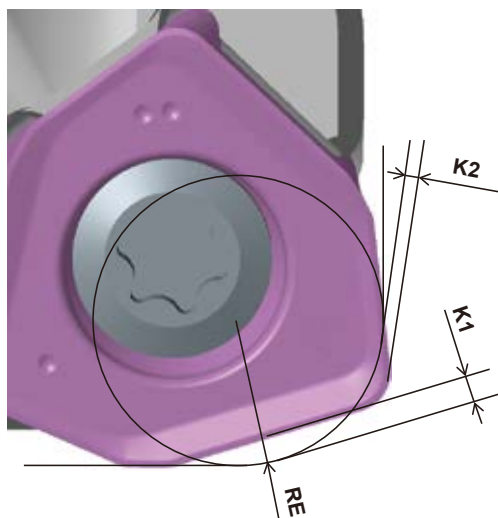

WJX14

RE (mm)	Remaining Stock K1 (mm)	Cutting Amount K2 (mm)
R3.0 (Recommendation)	1.41	0.00
R3.2	1.37	0.00
R4.0	1.17	0.10
R5.0	0.92	0.39

Depth of Cut ap (mm)	Remaining Stock H (mm)
1.0	0.05
1.5	0.08
2.0	0.12

ROTATING TOOLS

MULTI-FUNCTIONAL MILLING



VPX200

- P
- M
- K
- N
- S
- H

K

ROTATING TOOLS



Fig.1

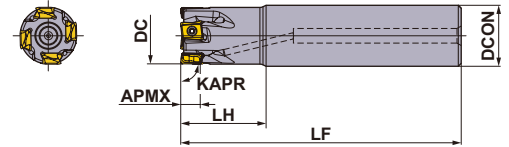
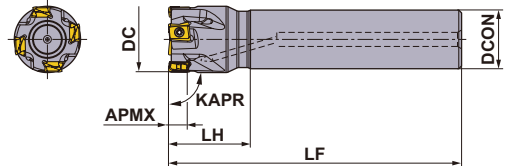

Fig.2



Right hand tool holder only.

■ CYLINDRICAL SHANK

With Coolant Hole

DC (mm)	Order Number	Stock R	Number of Teeth	Dimensions (mm)			APMX (mm)	RMPX	RPMX (min ⁻¹)	WT* (kg)	Fig.	Insert Type
				DCON	LF	LH						
16	VPX200R1602SA16S	●	2	16	85	25	8	1.85°	37900	0.11	1	LOGU09
18	VPX200R1802SA16S	★	2	16	85	25	8	1.56°	35300	0.12	2	LOGU09
18	VPX200R1802SA16L	●	2	16	120	25	8	1.56°	35300	0.17	2	LOGU09
20	VPX200R2002SA16S	★	2	16	100	25	8	1.35°	33200	0.14	2	LOGU09
20	VPX200R2003SA16S	●	3	16	100	25	8	1.35°	33200	0.14	2	LOGU09
20	VPX200R2002SA20S	●	2	20	100	30	8	1.35°	33200	0.21	1	LOGU09
20	VPX200R2003SA20S	●	3	20	100	30	8	1.35°	33200	0.21	1	LOGU09
20	VPX200R2002SA20L	●	2	20	150	60	8	1.35°	33200	0.32	1	LOGU09
22	VPX200R2202SA20S	★	2	20	115	30	8	1.16°	31400	0.26	2	LOGU09
22	VPX200R2203SA20S	●	3	20	115	30	8	1.16°	31400	0.25	2	LOGU09
22	VPX200R2202SA20L	★	2	20	150	30	8	1.16°	31400	0.34	2	LOGU09
25	VPX200R2503SA20S	●	3	20	115	30	8	0.97°	29000	0.26	2	LOGU09
25	VPX200R2504SA20S	●	4	20	115	30	8	0.97°	29000	0.26	2	LOGU09
25	VPX200R2503SA25S	●	3	25	115	35	8	0.97°	29000	0.39	1	LOGU09
25	VPX200R2504SA25S	●	4	25	115	35	8	0.97°	29000	0.39	1	LOGU09
25	VPX200R2503SA25L	●	3	25	170	70	8	0.97°	29000	0.57	1	LOGU09
28	VPX200R2803SA25S	★	3	25	115	35	8	0.84°	27200	0.41	2	LOGU09
28	VPX200R2804SA25S	★	4	25	115	35	8	0.84°	27200	0.41	2	LOGU09
28	VPX200R2803SA25L	★	3	25	170	35	8	0.84°	27200	0.61	2	LOGU09
30	VPX200R3003SA25S	★	3	25	125	35	8	0.77°	26000	0.46	2	LOGU09
30	VPX200R3004SA25S	★	4	25	125	35	8	0.77°	26000	0.46	2	LOGU09
32	VPX200R3203SA32S	★	3	32	125	45	8	0.71°	25100	0.70	1	LOGU09
32	VPX200R3204SA32S	●	4	32	125	45	8	0.71°	25100	0.70	1	LOGU09
32	VPX200R3205SA32S	●	5	32	125	45	8	0.71°	25100	0.70	1	LOGU09
32	VPX200R3203SA32L	●	3	32	190	90	8	0.71°	25100	1.06	1	LOGU09
35	VPX200R3503SA32L	★	3	32	190	45	8	0.63°	23800	1.14	2	LOGU09
40	VPX200R4004SA32S	★	4	32	125	45	8	0.54°	22000	0.81	2	LOGU09
40	VPX200R4006SA32S	★	6	32	125	45	8	0.54°	22000	0.80	2	LOGU09
50	VPX200R5005SA32S	★	5	32	125	45	8	0.42°	19200	0.91	2	LOGU09
50	VPX200R5007SA32S	★	7	32	125	45	8	0.42°	19200	0.91	2	LOGU09

Note 1) The maximum spindle speeds are set to ensure tool and insert stability.

Note 2) When using the tool at high spindle speeds, ensure that the tool and arbor are correctly balanced.

* WT : Tool Weight

● : Inventory maintained. ★ : Inventory maintained in Japan.

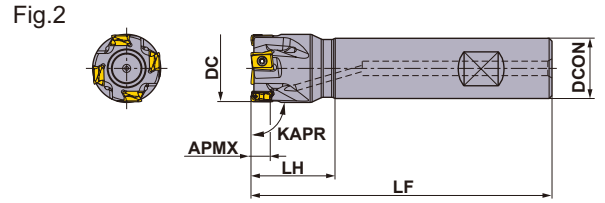
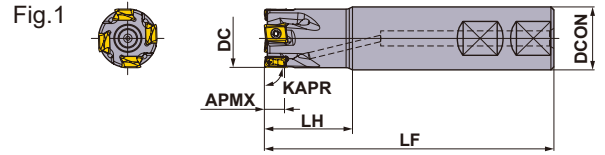

Right hand tool holder only.

WELDON SHANK TYPE

With Coolant Hole

DC (mm)	Order Number	Stock R	Number of Teeth	Dimensions (mm)			APMX (mm)	RMPX	RPMX (min ⁻¹)	WT* (kg)	Fig.	Insert Type
				DCON	LF	LH						
16	VPX200R1602WA16S	●	2	16	73	25	8	1.85°	37900	0.09	2	LOGU09
16	VPX200R1602WA16M	●	2	16	85	37	8	1.85°	37900	0.11	1	LOGU09
20	VPX200R2002WA20S	●	2	20	80	30	8	1.35°	33200	0.17	2	LOGU09
20	VPX200R2003WA20S	●	3	20	80	30	8	1.35°	33200	0.16	2	LOGU09
20	VPX200R2002WA20M	●	2	20	100	50	8	1.35°	33200	0.2	1	LOGU09
20	VPX200R2003WA20M	●	3	20	100	50	8	1.35°	33200	0.2	1	LOGU09
25	VPX200R2503WA25S	●	3	25	91	35	8	0.97°	29000	0.29	1	LOGU09
25	VPX200R2504WA25S	●	4	25	91	35	8	0.97°	29000	0.29	1	LOGU09
25	VPX200R2503WA25M	●	3	25	115	59	8	0.97°	29000	0.37	1	LOGU09
25	VPX200R2504WA25M	●	4	25	115	59	8	0.97°	29000	0.37	1	LOGU09
32	VPX200R3203WA32S	●	3	32	105	45	8	0.71°	25100	0.58	1	LOGU09
32	VPX200R3204WA32S	●	4	32	105	45	8	0.71°	25100	0.57	1	LOGU09
32	VPX200R3205WA32S	●	5	32	105	45	8	0.71°	25100	0.57	1	LOGU09
32	VPX200R3203WA32M	●	3	32	125	65	8	0.71°	25100	0.68	1	LOGU09
32	VPX200R3204WA32M	●	4	32	125	65	8	0.71°	25100	0.68	1	LOGU09
32	VPX200R3205WA32M	●	5	32	125	65	8	0.71°	25100	0.68	1	LOGU09

Note 1) The maximum spindle speeds are set to ensure tool and insert stability.

Note 2) When using the tool at high spindle speeds, ensure that the tool and arbor are correctly balanced.

* WT : Tool Weight

ROTATING TOOLS

K

ROTATING TOOLS

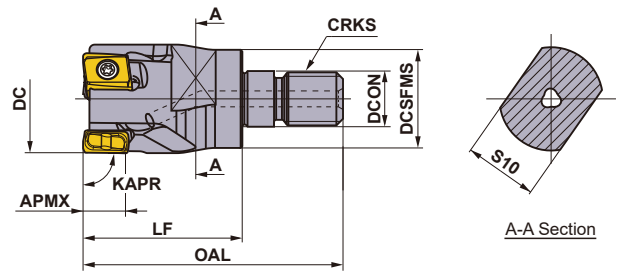
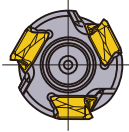

Right hand tool holder only.

SCREW-IN TYPE



With Coolant Hole

DC (mm)	Order Number	Stock R	Number of Teeth	Dimensions (mm)						WT* (kg)	APMX (mm)	RMPX	Insert Type
				DCON	DCSFMS	OAL	LF	S10	CRKS				
16	VPX200R1602AM0830	●	2	8.5	14.5	48	30	10	M08	0.03	8	1.85°	LOGU09
18	VPX200R1802AM0830	★	2	8.5	14.5	48	30	10	M08	0.04	8	1.56°	LOGU09
20	VPX200R2002AM1030	●	2	10.5	18.5	49	30	14	M10	0.06	8	1.35°	LOGU09
20	VPX200R2003AM1030	●	3	10.5	18.5	49	30	14	M10	0.06	8	1.35°	LOGU09
22	VPX200R2202AM1030	★	2	10.5	18.5	49	30	14	M10	0.06	8	1.16°	LOGU09
22	VPX200R2203AM1030	★	3	10.5	18.5	49	30	14	M10	0.06	8	1.16°	LOGU09
25	VPX200R2503AM1235	●	3	12.5	23.5	57	35	19	M12	0.11	8	0.97°	LOGU09
25	VPX200R2504AM1235	●	4	12.5	23.5	57	35	19	M12	0.11	8	0.97°	LOGU09
32	VPX200R3203AM1640	●	3	17.0	28.5	63	40	24	M16	0.21	8	0.71°	LOGU09
32	VPX200R3204AM1640	●	4	17.0	28.5	63	40	24	M16	0.21	8	0.71°	LOGU09
32	VPX200R3205AM1640	●	5	17.0	28.5	63	40	24	M16	0.21	8	0.71°	LOGU09
35	VPX200R3503AM1640	★	3	17.0	28.5	63	40	24	M16	0.24	8	0.63°	LOGU09
35	VPX200R3505AM1640	★	5	17.0	28.5	63	40	24	M16	0.23	8	0.63°	LOGU09
40	VPX200R4004AM1640	●	4	17.0	28.5	63	40	24	M16	0.26	8	0.54°	LOGU09
40	VPX200R4006AM1640	●	6	17.0	28.5	63	40	24	M16	0.26	8	0.54°	LOGU09

Note 1) For screw-in type arbors, refer to K244.

* WT : Tool Weight

SPARE PARTS

DC (mm)	Tool Holder Type	*		
				
		Clamp Screw	Wrench	Anti-seize Lubricant
16	VPX200R16	TPS27F1	TIP07F	MK1KS
18	VPX200R18	TPS27F1	TIP07F	MK1KS
20	VPX200R20	TPS27F1	TIP07F	MK1KS
22	VPX200R22	TPS27F2	TIP07F	MK1KS
25	VPX200R25	TPS27F2	TIP07F	MK1KS
28	VPX200R28	TPS27F2	TIP07F	MK1KS
30	VPX200R30	TPS27F2	TIP07F	MK1KS
32	VPX200R32	TPS27F2	TIP07F	MK1KS
35	VPX200R35	TPS27F2	TIP07F	MK1KS
40	VPX200R40	TPS27F2	TIP07F	MK1KS
50	VPX200R50	TPS27F2	TIP07F	MK1KS

* Clamp Torque (N · m) : TPS27F1=1.0, TPS27F2=1.0

● : Inventory maintained. ★ : Inventory maintained in Japan.

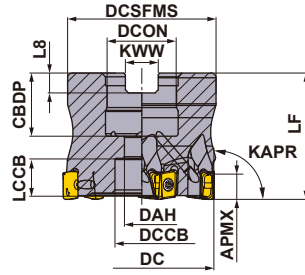

Right hand tool holder only.

DC	Set Bolt	Geometry
φ32, φ40	HSC08025H	
φ50, φ63	HSC10030H	

ARBOR TYPE

KAPR: 90°
GAMP: -6° GAMF: -25°
With Coolant Hole

DC (mm)	Order Number	Stock	Number of Teeth	Dimensions (mm)		WT* (kg)	APMX (mm)	RMPX	RPMX (min ⁻¹)	Insert Type
		R		LF	DCON					
32	VPX200-032A03AR	●	3	35	16	0.11	8	0.71°	25100	LOGU09
32	VPX200-032A05AR	●	5	35	16	0.11	8	0.71°	25100	LOGU09
40	VPX200-040A04AR	●	4	40	16	0.23	8	0.54°	22000	LOGU09
40	VPX200-040A06AR	●	6	40	16	0.22	8	0.54°	22000	LOGU09
50	VPX200-050A05AR	●	5	40	22	0.36	8	0.42°	19200	LOGU09
50	VPX200-050A07AR	●	7	40	22	0.36	8	0.42°	19200	LOGU09
63	VPX200-063A06AR	●	6	40	22	0.66	8	0.32°	16700	LOGU09
63	VPX200-063A09AR	●	9	40	22	0.66	8	0.32°	16700	LOGU09

Note 1) The maximum spindle speeds are set to ensure tool and insert stability.

Note 2) When using the tool at high spindle speeds, ensure that the tool and arbor are correctly balanced.

* WT : Tool Weight

MOUNTING DIMENSIONS

DC (mm)	Order Number	Dimensions (mm)							
		DCON	CBDP	DAH	DCCB	LCCB	DCSFMS	KWW	L8
32	VPX200-032A03AR	16	18	9	14	8	30	8.4	5.6
32	VPX200-032A05AR	16	18	9	14	8	30	8.4	5.6
40	VPX200-040A04AR	16	18	9	14	13	37	8.4	5.6
40	VPX200-040A06AR	16	18	9	14	13	37	8.4	5.6
50	VPX200-050A05AR	22	20	11	17	11	47	10.4	6.3
50	VPX200-050A07AR	22	20	11	17	11	47	10.4	6.3
63	VPX200-063A06AR	22	20	11	17	11	60	10.4	6.3
63	VPX200-063A09AR	22	20	11	17	11	60	10.4	6.3

SPARE PARTS

Tool Holder Type	*		
VPX200	Clamp Screw TPS27F2	Wrench TIP07F	Anti-seize Lubricant MK1KS

* Clamp Torque (N · m) : TPS27F2=1.0

ARBORS > K244
SPARE PARTS > N001
TECHNICAL DATA > P001

Cutting Conditions (Guide) :

● : Stable Cutting ● : General Cutting ✖ : Unstable Cutting

CHIPBREAKER RECOMMENDATION

Chipbreaker Selection Table

Work Material	Properties	Cutting Conditions	Chipbreaker		Grade			
			1st Recommendation	2nd Recommendation	1st Recommendation	2nd Recommendation		
P Mild Steel	Hardness ≤180HB	● ●	L	M	MP6120	VP15TF		
		✖	M	L	MP6130	—		
	Carbon Steel Alloy Steel Alloy Tool Steel (Annealing)	Hardness 180-350HB ≤350HB	● ●	L	M	MP6120	VP15TF	
			● ●	M	L	MP6120	VP15TF	
		(Annealing)	✖	M	L	MP6130	—	
			● ●	M	L	MP6120	VP15TF	
Pre-hardened Steel	Hardness 35—45HRC	● ●	M	L	MP6120	VP15TF		
		✖	M	L	MP6130	—		
M	Austenitic Stainless Steel	Hardness ≤280HB	● ●	L	M	MP7130	VP15TF	
			✖	M	L	MP7130	—	
		>200HB	● ●	L	M	MP7130	VP15TF	
			✖	M	L	MP7130	—	
	Duplex Stainless Steel	Hardness ≤280HB	● ●	L	M	MP7130	VP15TF	
			✖	M	L	MP7130	—	
	Ferritic and Martensitic Stainless Steel	—	● ●	L	M	MP7130	VP15TF	
			✖	M	L	MP7130	—	
	Precipitation Hardening Stainless Steel	Hardness <450HB	● ●	L	M	MP7130	VP15TF	
			✖	M	L	MP7130	—	
	K	Gray Cast Iron	Tensile Strength ≤350MPa	● ●	M	L	MC5020	VP15TF
				✖	M	L	VP15TF	—
Ductile Cast Iron		Tensile Strength ≤800MPa	● ●	M	L	MC5020	VP15TF	
			✖	M	L	VP15TF	—	
N	Aluminium Alloy	Content Si <5%	● ●	L	M	TF15	—	
			✖	M	L	TF15	—	
S	Titanium Alloy (Ti-6Al-4V, etc.)	—	● ●	L	M	MP9120	VP15TF	
			✖	M	L	MP9130	—	
	Titanium Alloy (Ti-5Al-5V-5Mo-3Cr, etc.)	—	● ●	L	M	MP9120	VP15TF	
			✖	M	L	MP9130	—	
	Heat Resistant Alloy	—	● ●	M	L	MP9120	VP15TF	
			✖	M	L	MP9130	—	
H	Hardened Steel	Hardness 40—55HRC	● ● ✖	M	—	VP15TF	—	

K

ROTATING TOOLS

ROTATING TOOLS

RECOMMENDED CUTTING CONDITIONS

■ Dry Cutting Cutting Speed

ROTATING TOOLS

K

Work Material	Properties	Cutting Conditions	Grade	ae (mm)			
				≤0.25DC	0.25–0.5DC	0.5–0.75DC	DC(Slot)
				Vc (m/min)			
P Mild Steel	Hardness ≤180HB	● ●	MP6120,VP15TF	230 (180–270)	220 (170–260)	180 (140–210)	180 (140–210)
		● ● ✱	MP6130	200 (150–240)	190 (140–230)	150 (110–180)	150 (110–180)
	Hardness 180–350HB ≤350HB (Annealing)	● ●	MP6120,VP15TF	180 (140–210)	170 (130–200)	140 (110–160)	140 (110–160)
		● ● ✱	MP6130	150 (110–180)	140 (100–170)	110 (80–130)	110 (80–130)
Pre-hardened Steel	Hardness 35–45HRC	● ●	MP6120,VP15TF	120 (90–140)	110 (80–130)	100 (70–120)	100 (70–120)
		● ● ✱	MP6130	100 (80–120)	90 (70–110)	80 (60–100)	80 (60–100)
M Austenitic Stainless Steel	Hardness ≤200HB	● ● ✱	MP7130,VP15TF	180 (140–210)	170 (130–200)	140 (110–160)	140 (110–160)
		● ● ✱	MP7130,VP15TF	150 (110–180)	140 (100–160)	110 (80–130)	110 (80–130)
	Hardness >200HB	● ● ✱	MP7130,VP15TF	140 (110–170)	130 (90–150)	100 (70–120)	100 (70–120)
		● ● ✱	MP7130,VP15TF	180 (140–210)	170 (130–200)	140 (110–160)	140 (110–160)
		● ● ✱	MP7130,VP15TF	130 (100–160)	120 (80–140)	90 (60–110)	90 (60–110)
K Gray Cast Iron	Tensile Strength ≤350MPa	● ●	MC5020	250 (200–300)	240 (190–290)	210 (160–260)	210 (160–260)
		● ● ✱	VP15TF	200 (150–250)	190 (140–240)	160 (110–210)	160 (110–210)
Ductile Cast Iron	Tensile Strength ≤800MPa	● ●	MC5020	180 (150–200)	170 (140–190)	150 (120–170)	150 (120–170)
		● ● ✱	VP15TF	130 (100–150)	120 (90–140)	100 (80–120)	100 (80–120)
N Aluminium Alloy	Content Si <5%	● ● ✱	TF15	600 (400–1000)	600 (400–1000)	600 (400–1000)	600 (400–1000)
H Hardened Steel	Hardness 40–55HRC	● ● ✱	VP15TF	90 (70–100)	85 (60–100)	70 (50–80)	70 (50–80)

Note 1) These cutting conditions should be referenced for standard shank types (last letter in designation is S) and arbor shank types. If there is chatter, insert chipping, etc. during machining, alter conditions accordingly.

Note 2) Chattering and vibrations are more likely under the following circumstances. Use a cut and feed per tooth that are at minimum recommended conditions or below.

- When tool overhang is long (using a long shank, screw-in type, etc.)
- Rigidity of machine, work material or attachment of work material is low
- At a corner radius during pocket milling

Note 3) A type with fewer teeth is recommended when the depth of cut in the radial direction (ae) is 0.5 DC or more.

Note 4) Wet cutting is recommended, when focusing on the surface finish. (Service life is shorter than for dry cutting.)

Note 5) When using higher than recommended cutting conditions, or for long periods of time, the clamp screw may become fatigued and break during machining. Please change out the clamp screw periodically.

Depth of Cut / Feed per Tooth

Work Material	Properties	ae	Cutting Conditions	DC (mm)					
				ø16–ø18		ø20–ø25		ø28–ø63	
				ap	fz (mm/t.)	ap	fz (mm/t.)	ap	fz (mm/t.)
P Mild Steel	Hardness ≤180HB	≤0.25DC	● ● ✱	≤6	0.10–0.15	≤8	0.10–0.20	≤8	0.10–0.25
		0.25–0.5DC	● ● ✱	≤5	0.08–0.12	≤8	0.10–0.15	≤8	0.10–0.20
		0.5–0.75DC	● ● ✱	≤4	0.08–0.12	≤6	0.08–0.12	≤6	0.10–0.15
		DC(Slot)	● ● ✱	≤2	0.06–0.10	≤4	0.06–0.10	≤4	0.08–0.12
Carbon Steel Alloy Steel Alloy Tool Steel	Hardness 180–280HB	≤0.25DC	● ● ✱	≤6	0.10–0.15	≤8	0.10–0.20	≤8	0.10–0.25
		0.25–0.5DC	● ● ✱	≤5	0.08–0.12	≤8	0.10–0.15	≤8	0.10–0.20
		0.5–0.75DC	● ● ✱	≤4	0.08–0.12	≤6	0.08–0.12	≤6	0.10–0.15
		DC(Slot)	● ● ✱	≤2	0.06–0.10	≤4	0.06–0.10	≤4	0.08–0.12
Carbon Steel Alloy Steel Alloy Tool Steel	Hardness 280–350HB ≤350HB (Annealing)	≤0.25DC	● ● ✱	≤6	0.10–0.15	≤8	0.10–0.15	≤8	0.10–0.20
		0.25–0.5DC	● ● ✱	≤5	0.08–0.12	≤8	0.08–0.12	≤8	0.10–0.15
		0.5–0.75DC	● ● ✱	≤4	0.08–0.12	≤6	0.06–0.10	≤6	0.08–0.12
		DC(Slot)	● ● ✱	≤2	0.06–0.10	≤4	0.06–0.10	≤4	0.05–0.10
Pre-hardened Steel	Hardness 35–45HRC	≤0.25DC	● ● ✱	≤6	0.10–0.15	≤8	0.10–0.15	≤8	0.10–0.20
		0.25–0.5DC	● ● ✱	≤5	0.08–0.12	≤8	0.08–0.12	≤8	0.10–0.15
		0.5–0.75DC	● ● ✱	≤4	0.08–0.12	≤6	0.06–0.10	≤6	0.08–0.12
		DC(Slot)	● ● ✱	≤2	0.06–0.10	≤4	0.06–0.10	≤4	0.06–0.10

Cutting Conditions (Guide) :

● : Stable Cutting ● : General Cutting ✖ : Unstable Cutting

Depth of Cut / Feed per Tooth

Work Material	Properties	ae	Cutting Conditions	DC (mm)						
				ø16-ø18		ø20-ø25		ø28-ø63		
				ap	fz (mm/t.)	ap	fz (mm/t.)	ap	fz (mm/t.)	
M	Austenitic Stainless Steel	≤0.25DC	● ●	≤6	0.10-0.15	≤8	0.10-0.20	≤8	0.10-0.20	
			● ● ✖	≤6	0.08-0.12	≤8	0.08-0.15	≤8	0.08-0.15	
		0.25-0.5DC	● ●	≤5	0.08-0.12	≤8	0.08-0.15	≤8	0.08-0.15	
			● ● ✖	≤5	0.06-0.10	≤8	0.08-0.12	≤8	0.08-0.12	
	0.5-0.75DC	● ●	≤4	0.06-0.10	≤6	0.08-0.12	≤6	0.08-0.12		
		● ● ✖	≤4	0.06-0.08	≤6	0.06-0.10	≤6	0.06-0.10		
	DC(Slot)	● ●	≤2	0.06-0.10	≤4	0.06-0.10	≤4	0.06-0.10		
		● ● ✖	≤2	0.06-0.08	≤4	0.06-0.08	≤4	0.06-0.08		
	Duplex Stainless Steel	Hardness ≤280HB	≤0.25DC	● ●	≤6	0.10-0.15	≤8	0.10-0.20	≤8	0.10-0.20
				● ● ✖	≤6	0.08-0.12	≤8	0.08-0.15	≤8	0.08-0.15
		0.25-0.5DC	● ●	≤5	0.08-0.12	≤8	0.08-0.15	≤8	0.08-0.15	
			● ● ✖	≤5	0.06-0.10	≤8	0.08-0.12	≤8	0.08-0.12	
	0.5-0.75DC	● ●	≤4	0.06-0.10	≤6	0.08-0.12	≤6	0.08-0.12		
		● ● ✖	≤4	0.06-0.08	≤6	0.06-0.10	≤6	0.06-0.10		
	DC(Slot)	● ●	≤2	0.06-0.10	≤4	0.06-0.10	≤4	0.06-0.10		
		● ● ✖	≤2	0.06-0.08	≤4	0.06-0.08	≤4	0.06-0.08		
Ferritic and Martensitic Stainless Steel	-	≤0.25DC	● ●	≤6	0.10-0.15	≤8	0.10-0.20	≤8	0.10-0.20	
			● ● ✖	≤6	0.08-0.12	≤8	0.08-0.15	≤8	0.08-0.15	
	0.25-0.5DC	● ●	≤5	0.08-0.12	≤8	0.08-0.15	≤8	0.08-0.15		
		● ● ✖	≤5	0.06-0.10	≤8	0.08-0.12	≤8	0.08-0.12		
0.5-0.75DC	● ●	≤4	0.06-0.10	≤6	0.08-0.12	≤6	0.08-0.12			
	● ● ✖	≤4	0.06-0.08	≤6	0.06-0.10	≤6	0.06-0.10			
DC(Slot)	● ●	≤2	0.06-0.10	≤4	0.06-0.10	≤4	0.06-0.10			
	● ● ✖	≤2	0.06-0.08	≤4	0.06-0.08	≤4	0.06-0.08			
Precipitation Hardening Stainless Steel	Hardness <450HB	≤0.25DC	● ●	≤6	0.10-0.15	≤8	0.10-0.15	≤8	0.10-0.15	
			● ● ✖	≤6	0.08-0.12	≤8	0.08-0.12	≤8	0.08-0.12	
	0.25-0.5DC	● ●	≤5	0.08-0.12	≤8	0.08-0.12	≤8	0.08-0.12		
		● ● ✖	≤5	0.06-0.10	≤8	0.08-0.12	≤8	0.08-0.12		
0.5-0.75DC	● ●	≤4	0.06-0.10	≤6	0.06-0.10	≤6	0.06-0.10			
	● ● ✖	≤4	0.06-0.08	≤6	0.06-0.08	≤6	0.06-0.08			
DC(Slot)	● ●	≤2	0.06-0.10	≤4	0.06-0.10	≤4	0.06-0.10			
	● ● ✖	≤2	0.06-0.08	≤4	0.06-0.08	≤4	0.06-0.08			
K	Gray Cast Iron	Tensile Strength ≤350MPa	● ●	● ●	≤6	0.10-0.15	≤8	0.10-0.20	≤8	0.10-0.25
				● ● ✖	≤6	0.08-0.12	≤8	0.08-0.15	≤8	0.10-0.20
		0.25-0.5DC	● ●	≤5	0.08-0.12	≤8	0.08-0.15	≤8	0.10-0.20	
			● ● ✖	≤5	0.06-0.10	≤8	0.08-0.12	≤8	0.10-0.15	
	0.5-0.75DC	● ●	≤4	0.08-0.12	≤6	0.08-0.12	≤6	0.10-0.15		
		● ● ✖	≤4	0.08-0.12	≤6	0.06-0.10	≤6	0.08-0.12		
	DC(Slot)	● ●	≤2	0.06-0.10	≤4	0.06-0.10	≤4	0.08-0.15		
		● ● ✖	≤2	0.06-0.08	≤4	0.06-0.08	≤4	0.08-0.10		
	Ductile Cast Iron	Tensile Strength ≤800MPa	≤0.25DC	● ●	≤6	0.10-0.15	≤8	0.10-0.20	≤8	0.10-0.20
				● ● ✖	≤6	0.08-0.12	≤8	0.10-0.15	≤8	0.10-0.15
		0.25-0.5DC	● ●	≤5	0.08-0.12	≤8	0.10-0.15	≤8	0.10-0.15	
			● ● ✖	≤5	0.06-0.10	≤8	0.08-0.12	≤8	0.08-0.12	
0.5-0.75DC	● ●	≤4	0.08-0.12	≤6	0.08-0.12	≤6	0.08-0.12			
	● ● ✖	≤4	0.08-0.12	≤6	0.06-0.10	≤6	0.06-0.10			
DC(Slot)	● ●	≤2	0.06-0.10	≤4	0.06-0.10	≤4	0.06-0.10			
	● ● ✖	≤2	0.06-0.08	≤4	0.06-0.08	≤4	0.06-0.08			
N	Aluminium Alloy	Content Si <5%	● ●	● ●	≤6	0.10-0.20	≤8	0.10-0.25	≤8	0.10-0.25
				● ● ✖	≤6	0.10-0.15	≤8	0.10-0.20	≤8	0.10-0.20
		0.25-0.5DC	● ●	≤5	0.10-0.15	≤8	0.10-0.20	≤8	0.10-0.20	
			● ● ✖	≤5	0.08-0.12	≤8	0.10-0.15	≤8	0.10-0.15	
0.5-0.75DC	● ●	≤4	0.08-0.12	≤6	0.06-0.15	≤6	0.08-0.15			
	● ● ✖	≤4	0.06-0.10	≤6	0.06-0.15	≤6	0.08-0.15			
DC(Slot)	● ●	≤2	0.06-0.10	≤4	0.06-0.15	≤4	0.08-0.15			
	● ● ✖	≤2	0.06-0.08	≤4	0.06-0.12	≤4	0.08-0.12			
H	Hardened Steel	Hardness 40-55HRC	● ●	● ●	≤4	0.08-0.15	≤4	0.08-0.15	≤4	0.08-0.15
				● ● ✖	≤4	0.08-0.12	≤4	0.08-0.12	≤4	0.08-0.12
			0.25-0.5DC	● ●	≤3	0.08-0.12	≤3	0.08-0.12	≤3	0.08-0.12
				● ● ✖	≤3	0.06-0.10	≤3	0.08-0.10	≤3	0.06-0.10
		0.5-0.75DC	● ●	≤2	0.06-0.10	≤2	0.08-0.10	≤2	0.06-0.10	
			● ● ✖	≤2	0.06-0.08	≤2	0.06-0.08	≤2	0.06-0.08	
		DC(Slot)	● ●	≤1	0.06-0.10	≤1	0.06-0.10	≤1	0.06-0.10	
			● ● ✖	≤1	0.06-0.08	≤1	0.06-0.08	≤1	0.06-0.08	

Note 1) These cutting conditions should be referenced for standard shank types (last letter in designation is S) and arbor shank types. If there is chatter, insert chipping, etc. during machining, alter conditions accordingly.

Note 2) Chattering and vibrations are more likely under the following circumstances. Use a cut and feed per tooth that are at minimum recommended conditions or below.

- When tool overhang is long (using a long shank, screw-in type, etc.)
- Rigidity of machine, work material or attachment of work material is low
- At a corner radius during pocket milling

Note 3) A type with fewer teeth is recommended when the depth of cut in the radial direction (ae) is 0.5 DC or more.

Note 4) Wet cutting is recommended, when focusing on the surface finish. (Service life is shorter than for dry cutting.)

Note 5) When using higher than recommended cutting conditions, or for long periods of time, the clamp screw may become fatigued and break during machining. Please change out the clamp screw periodically.

K

ROTATING TOOLS

ROTATING TOOLS

RECOMMENDED CUTTING CONDITIONS

Wet Cutting Cutting Speed

Work Material	Properties	Cutting Conditions	Grade	ae (mm)							
				≤0.25DC	0.25–0.5DC	0.5–0.75DC	DC(Slot)				
				Vc (m/min)							
P Mild Steel	Hardness ≤180HB	● ● ✖	MP6120 MP6130 VP15TF	140 (100–190)	130 (90–180)	100 (70–120)	100 (70–120)				
				Carbon Steel Alloy Steel Alloy Tool Steel	Hardness 180–350HB ≤350HB (Annealing)	● ● ✖	MP6120 MP6130 VP15TF	120 (90–140)	110 (80–130)	100 (70–120)	100 (70–120)
								Pre-hardened Steel	Hardness 35–45HRC	● ● ✖	MP6120 MP6130 VP15TF
M Austenitic Stainless Steel	Hardness ≤200HB	● ● ✖	MP7130,VP15TF	120 (100–150)	110 (90–140)	90 (70–120)	90 (70–120)				
				Duplex Stainless Steel	Hardness ≤280HB	● ● ✖	MP7130,VP15TF	100 (80–130)	90 (70–110)	70 (50–100)	70 (50–100)
	Ferritic and Martensitic Stainless Steel	–	● ● ✖					MP7130,VP15TF	120 (100–150)	110 (90–140)	90 (70–120)
				Precipitation Hardening Stainless Steel	Hardness <450HB	● ● ✖	MP7130,VP15TF		90 (70–120)	80 (60–110)	60 (40–90)
	K Gray Cast Iron	Tensile Strength ≤350MPa	● ● ✖					MC5020 VP15TF	180 (160–220)	170 (150–210)	150 (130–190)
Ductile Cast Iron				Tensile Strength ≤800MPa	● ● ✖	MC5020 VP15TF	160 (140–180)		150 (130–170)	130 (110–150)	130 (110–150)
	N Aluminium Alloy	Content Si <5%	● ● ✖				TF15	600 (400–1000)	600 (400–1000)	600 (400–1000)	600 (400–1000)
S Titanium Alloy (Ti-6Al-4V, etc.)				–	● ● ✖	MP9120,VP15TF MP9130		50 (40–70)	50 (40–70)	50 (40–70)	50 (40–70)
	Titanium Alloy (Ti-5Al-5V-5Mo-3Cr, etc.)	–	● ● ✖				MP9120 MP9130 VP15TF	30 (20–40)	30 (20–40)	30 (20–40)	30 (20–40)
				Heat Resistant Alloy	–	● ● ✖		MP9120,VP15TF MP9130	40 (30–60)	40 (30–60)	40 (30–60)
	H Hardened Steel	Hardness 40–55HRC	● ● ✖				VP15TF		90 (70–100)	85 (60–100)	70 (50–80)

Note 1) These cutting conditions should be referenced for standard shank types (last letter in designation is S) and arbor shank types. If there is chatter, insert chipping, etc. during machining, alter conditions accordingly.

Note 2) Chattering and vibrations are more likely under the following circumstances. Use a cut and feed per tooth that are at minimum recommended conditions or below.

- When tool overhang is long (using a long shank, screw-in type, etc.)
- Rigidity of machine, work material or attachment of work material is low
- At a corner radius during pocket milling

Note 3) A type with fewer teeth is recommended when the depth of cut in the radial direction (ae) is 0.5 DC or more.

Note 4) Wet cutting is recommended, when focusing on the surface finish. (Service life is shorter than for dry cutting.)

Note 5) When using higher than recommended cutting conditions, or for long periods of time, the clamp screw may become fatigued and break during machining. Please change out the clamp screw periodically.

K

ROTATING TOOLS

Cutting Conditions (Guide) :

● : Stable Cutting ● : General Cutting ✖ : Unstable Cutting

Depth of Cut / Feed per Tooth

Work Material	Properties	ae	Cutting Conditions	DC (mm)						
				ø16-ø18		ø20-ø25		ø28-ø63		
				ap	fz (mm/t.)	ap	fz (mm/t.)	ap	fz (mm/t.)	
P	Mild Steel	≤0.25DC	● ● ✖	≤6	0.10-0.15	≤8	0.10-0.20	≤8	0.10-0.25	
		0.25-0.5DC	● ● ✖	≤5	0.08-0.12	≤8	0.10-0.15	≤8	0.10-0.20	
		0.5-0.75DC	● ● ✖	≤4	0.08-0.12	≤6	0.08-0.12	≤6	0.10-0.15	
		DC(Slot)	● ● ✖	≤2	0.06-0.10	≤4	0.06-0.10	≤4	0.08-0.12	
	Carbon Steel Alloy Steel Alloy Tool Steel	Hardness 180-280HB	≤0.25DC	● ● ✖	≤6	0.10-0.15	≤8	0.10-0.20	≤8	0.10-0.25
			0.25-0.5DC	● ● ✖	≤5	0.08-0.12	≤8	0.10-0.15	≤8	0.10-0.20
			0.5-0.75DC	● ● ✖	≤4	0.08-0.12	≤6	0.08-0.12	≤6	0.10-0.15
			DC(Slot)	● ● ✖	≤2	0.06-0.10	≤4	0.06-0.10	≤4	0.08-0.12
	Carbon Steel Alloy Steel Alloy Tool Steel	Hardness 280-350HB ≤350HB (Annealing)	≤0.25DC	● ● ✖	≤6	0.10-0.15	≤8	0.10-0.15	≤8	0.10-0.20
			0.25-0.5DC	● ● ✖	≤5	0.08-0.12	≤8	0.08-0.12	≤8	0.10-0.15
			0.5-0.75DC	● ● ✖	≤4	0.08-0.12	≤6	0.06-0.10	≤6	0.08-0.12
			DC(Slot)	● ● ✖	≤2	0.06-0.10	≤4	0.06-0.10	≤4	0.06-0.10
Pre-hardened Steel	Hardness 35-45HRC	≤0.25DC	● ● ✖	≤6	0.10-0.15	≤8	0.10-0.15	≤8	0.10-0.20	
		0.25-0.5DC	● ● ✖	≤5	0.08-0.12	≤8	0.08-0.12	≤8	0.10-0.15	
		0.5-0.75DC	● ● ✖	≤4	0.08-0.12	≤6	0.06-0.10	≤6	0.08-0.12	
		DC(Slot)	● ● ✖	≤2	0.06-0.10	≤4	0.06-0.10	≤4	0.06-0.10	
M	Austenitic Stainless Steel	-	≤0.25DC	● ● ✖	≤6	0.10-0.15	≤8	0.10-0.20	≤8	0.10-0.20
			0.25-0.5DC	● ● ✖	≤5	0.08-0.12	≤8	0.08-0.15	≤8	0.08-0.15
			0.5-0.75DC	● ● ✖	≤4	0.06-0.10	≤6	0.08-0.12	≤6	0.08-0.12
			DC(Slot)	● ● ✖	≤2	0.06-0.10	≤4	0.06-0.10	≤4	0.06-0.10
	Duplex Stainless Steel	Hardness ≤280HB	≤0.25DC	● ● ✖	≤6	0.10-0.15	≤8	0.10-0.20	≤8	0.10-0.20
			0.25-0.5DC	● ● ✖	≤5	0.08-0.12	≤8	0.08-0.15	≤8	0.08-0.12
			0.5-0.75DC	● ● ✖	≤4	0.06-0.10	≤6	0.08-0.12	≤6	0.08-0.12
			DC(Slot)	● ● ✖	≤2	0.06-0.10	≤4	0.06-0.10	≤4	0.06-0.10
	Ferritic and Martensitic Stainless Steel	-	≤0.25DC	● ● ✖	≤6	0.10-0.15	≤8	0.10-0.20	≤8	0.10-0.20
			0.25-0.5DC	● ● ✖	≤5	0.08-0.12	≤8	0.08-0.15	≤8	0.08-0.15
			0.5-0.75DC	● ● ✖	≤4	0.06-0.10	≤6	0.08-0.12	≤6	0.08-0.12
			DC(Slot)	● ● ✖	≤2	0.06-0.10	≤4	0.06-0.10	≤4	0.05-0.10
Precipitation Hardening Stainless Steel	Hardness <450HB	≤0.25DC	● ● ✖	≤6	0.10-0.15	≤8	0.10-0.15	≤8	0.10-0.15	
		0.25-0.5DC	● ● ✖	≤5	0.08-0.12	≤8	0.08-0.12	≤8	0.08-0.12	
		0.5-0.75DC	● ● ✖	≤4	0.06-0.10	≤6	0.06-0.10	≤6	0.05-0.10	
		DC(Slot)	● ● ✖	≤2	0.06-0.10	≤4	0.06-0.10	≤4	0.05-0.10	
K	Gray Cast Iron	Tensile Strength ≤350MPa	≤0.25DC	● ● ✖	≤6	0.10-0.15	≤8	0.10-0.20	≤8	0.10-0.25
			0.25-0.5DC	● ● ✖	≤5	0.08-0.12	≤8	0.08-0.15	≤8	0.10-0.20
			0.5-0.75DC	● ● ✖	≤4	0.08-0.12	≤6	0.06-0.10	≤6	0.10-0.15
			DC(Slot)	● ● ✖	≤2	0.06-0.10	≤4	0.06-0.10	≤4	0.08-0.15
	Ductile Cast Iron	Tensile Strength ≤800MPa	≤0.25DC	● ● ✖	≤6	0.10-0.15	≤8	0.10-0.20	≤8	0.10-0.20
			0.25-0.5DC	● ● ✖	≤5	0.08-0.12	≤8	0.10-0.15	≤8	0.10-0.15
			0.5-0.75DC	● ● ✖	≤4	0.08-0.12	≤6	0.08-0.12	≤6	0.08-0.12
			DC(Slot)	● ● ✖	≤2	0.06-0.10	≤4	0.06-0.10	≤4	0.06-0.10

Note 1) These cutting conditions should be referenced for standard shank types (last letter in designation is S) and arbor shank types. If there is chatter, insert chipping, etc. during machining, alter conditions accordingly.
 Note 2) Chattering and vibrations are more likely under the following circumstances. Use a cut and feed per tooth that are at minimum recommended conditions or below.
 • When tool overhang is long (using a long shank, screw-in type, etc.)
 • Rigidity of machine, work material or attachment of work material is low
 • At a corner radius during pocket milling
 Note 3) A type with fewer teeth is recommended when the depth of cut in the radial direction (ae) is 0.5 DC or more.
 Note 4) Wet cutting is recommended, when focusing on the surface finish. (Service life is shorter than for dry cutting.)
 Note 5) When using higher than recommended cutting conditions, or for long periods of time, the clamp screw may become fatigued and break during machining. Please change out the clamp screw periodically.

K
ROTATING TOOLS

ROTATING TOOLS

Cutting Conditions (Guide) :

● : Stable Cutting ● : General Cutting ✖ : Unstable Cutting

RECOMMENDED CUTTING CONDITIONS

Wet Cutting

Depth of Cut / Feed per Tooth

Work Material	Properties	ae	Cutting Conditions	DC (mm)					
				ø16-ø18		ø20-ø25		ø28-ø63	
				ap	fz (mm/t.)	ap	fz (mm/t.)	ap	fz (mm/t.)
N Aluminium Alloy	Content Si < 5%	≤0.25DC	● ● ✖	≤6	0.10-0.20	≤8	0.10-0.25	≤8	0.10-0.25
			● ● ✖	≤6	0.10-0.15	≤8	0.10-0.20	≤8	0.10-0.20
		0.25-0.5DC	● ● ✖	≤5	0.10-0.15	≤8	0.10-0.20	≤8	0.10-0.20
			● ● ✖	≤5	0.08-0.12	≤8	0.10-0.15	≤8	0.10-0.15
		0.5-0.75DC	● ● ✖	≤4	0.08-0.12	≤6	0.06-0.15	≤6	0.08-0.15
DC(Slot)	● ● ✖	≤2	0.06-0.10	≤6	0.06-0.15	≤6	0.08-0.15		
S Titanium Alloy (Ti-6Al-4V, etc.) Titanium Alloy (Ti-5Al-5V-5Mo-3Cr, etc.) Heat Resistant Alloy	-	≤0.25DC	● ● ✖	≤6	0.08-0.15	≤8	0.08-0.15	≤8	0.08-0.15
		0.25-0.5DC	● ● ✖	≤5	0.08-0.12	≤8	0.08-0.12	≤8	0.08-0.12
		0.5-0.75DC	● ● ✖	≤4	0.06-0.10	≤6	0.06-0.10	≤6	0.06-0.10
		DC(Slot)	● ● ✖	≤2	0.06-0.10	≤4	0.06-0.10	≤4	0.06-0.10
	-	≤0.25DC	● ● ✖	≤6	0.08-0.12	≤8	0.08-0.12	≤8	0.08-0.12
		0.25-0.5DC	● ● ✖	≤5	0.08-0.12	≤8	0.08-0.12	≤8	0.08-0.12
		0.5-0.75DC	● ● ✖	≤4	0.06-0.10	≤6	0.06-0.10	≤6	0.06-0.10
		DC(Slot)	● ● ✖	≤2	0.06-0.10	≤4	0.06-0.10	≤4	0.06-0.10
	-	≤0.25DC	● ● ✖	≤6	0.08-0.12	≤8	0.08-0.12	≤8	0.08-0.12
		0.25-0.5DC	● ● ✖	≤5	0.08-0.12	≤8	0.08-0.12	≤8	0.08-0.12
		0.5-0.75DC	● ● ✖	≤4	0.06-0.10	≤6	0.06-0.10	≤6	0.06-0.10
		DC(Slot)	● ● ✖	≤2	0.06-0.10	≤4	0.06-0.10	≤4	0.06-0.10
H Hardened Steel	Hardness 40-55HRC	≤0.25DC	● ● ✖	≤4	0.08-0.15	≤4	0.08-0.15	≤4	0.08-0.15
			● ● ✖	≤4	0.08-0.12	≤4	0.08-0.12	≤4	0.08-0.12
		0.25-0.5DC	● ● ✖	≤3	0.08-0.12	≤3	0.08-0.12	≤3	0.08-0.12
			● ● ✖	≤3	0.06-0.10	≤3	0.06-0.10	≤3	0.06-0.10
		0.5-0.75DC	● ● ✖	≤2	0.06-0.10	≤2	0.06-0.10	≤2	0.06-0.10
			● ● ✖	≤2	0.06-0.10	≤2	0.06-0.10	≤2	0.06-0.10
		DC(Slot)	● ● ✖	≤1	0.06-0.10	≤1	0.06-0.10	≤1	0.06-0.10
			● ● ✖	≤1	0.06-0.10	≤1	0.06-0.10	≤1	0.06-0.10

Note 1) These cutting conditions should be referenced for standard shank types (last letter in designation is S) and arbor shank types. If there is chatter, insert chipping, etc. during machining, alter conditions accordingly.

Note 2) Chattering and vibrations are more likely under the following circumstances. Use a cut and feed per tooth that are at minimum recommended conditions or below.

- When tool overhang is long (using a long shank, screw-in type, etc.)
- Rigidity of machine, work material or attachment of work material is low
- At a corner radius during pocket milling

Note 3) A type with fewer teeth is recommended when the depth of cut in the radial direction (ae) is 0.5 DC or more.

Note 4) Wet cutting is recommended, when focusing on the surface finish. (Service life is shorter than for dry cutting.)

Note 5) When using higher than recommended cutting conditions, or for long periods of time, the clamp screw may become fatigued and break during machining. Please change out the clamp screw periodically.

K

ROTATING TOOLS

■ Ramping / Helical Cutting

● Ramping

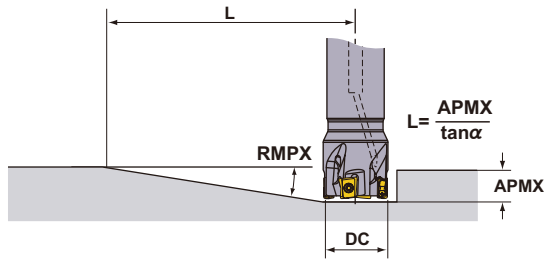

● Helical Cutting

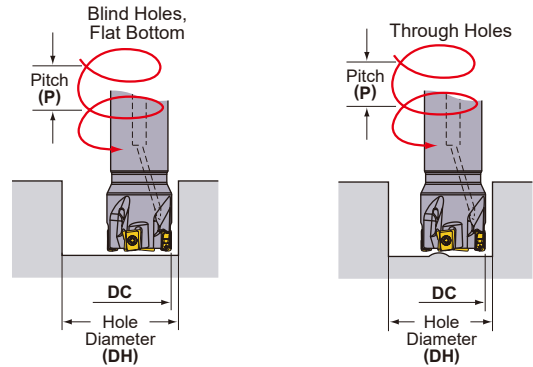

Refer to the table below for cutting conditions. For feed per tooth and cutting speed, follow the cutting conditions for slot milling.

DC (mm)	RE (mm)	Ramping		Helical Cutting (Blind Hole, Flat Bottom)				Helical Cutting (Through Hole)	
		RMPX	L (mm) *	DH max. (mm)	P max. (mm)	DH min. (mm)	P max. (mm)	DH min. (mm)	P max. (mm)
16	0.2	1.85°	248	31.0	1.5	27.5	1.2	24.2	0.8
	0.4	1.85°	248	30.6	1.5	27.5	1.2	24.2	0.8
	0.8	1.85°	248	29.8	1.4	27.5	1.2	24.2	0.8
	1.0	1.85°	248	29.4	1.4	27.5	1.2	24.2	0.8
	1.2	1.85°	248	29.0	1.3	27.5	1.2	24.2	0.8
	1.6	1.85°	248	28.2	1.2	27.5	1.2	24.2	0.8
18	0.2	1.56°	294	35.0	1.5	31.5	1.2	28.1	0.9
	0.4	1.56°	294	34.6	1.4	31.5	1.2	28.1	0.9
	0.8	1.56°	294	33.8	1.4	31.5	1.2	28.1	0.9
	1.0	1.56°	294	33.4	1.3	31.5	1.2	28.1	0.9
	1.2	1.56°	294	33.0	1.3	31.5	1.2	28.1	0.9
	1.6	1.56°	294	32.2	1.2	31.5	1.2	28.1	0.9
20	0.2	1.35°	340	39.0	1.4	35.5	1.1	32.0	0.9
	0.4	1.35°	340	38.6	1.4	35.5	1.1	32.0	0.9
	0.8	1.35°	340	37.8	1.3	35.5	1.1	32.0	0.9
	1.0	1.35°	340	37.4	1.3	35.5	1.1	32.0	0.9
	1.2	1.35°	340	37.0	1.3	35.5	1.1	32.0	0.9
	1.6	1.35°	340	36.2	1.2	35.5	1.1	32.0	0.9
22	0.2	1.16°	396	43.0	1.3	39.5	1.1	36.0	0.9
	0.4	1.16°	396	42.6	1.3	39.5	1.1	36.0	0.9
	0.8	1.16°	396	41.8	1.3	39.5	1.1	36.0	0.9
	1.0	1.16°	396	41.4	1.2	39.5	1.1	36.0	0.9
	1.2	1.16°	396	41.0	1.2	39.5	1.1	36.0	0.9
	1.6	1.16°	396	40.2	1.2	39.5	1.1	36.0	0.9
25	0.2	0.97°	473	49.0	1.3	45.5	1.1	42.0	0.9
	0.4	0.97°	473	48.6	1.3	45.5	1.1	42.0	0.9
	0.8	0.97°	473	47.8	1.2	45.5	1.1	42.0	0.9
	1.0	0.97°	473	47.4	1.2	45.5	1.1	42.0	0.9
	1.2	0.97°	473	47.0	1.2	45.5	1.1	42.0	0.9
	1.6	0.97°	473	46.2	1.1	45.5	1.1	42.0	0.9
28	0.2	0.84°	546	55.0	1.2	51.5	1.1	48.0	0.9
	0.4	0.84°	546	54.6	1.2	51.5	1.1	48.0	0.9
	0.8	0.84°	546	53.8	1.2	51.5	1.1	48.0	0.9
	1.0	0.84°	546	53.4	1.2	51.5	1.1	48.0	0.9
	1.2	0.84°	546	53.0	1.2	51.5	1.1	48.0	0.9
	1.6	0.84°	546	52.2	1.1	51.5	1.1	48.0	0.9
30	0.2	0.77°	596	59.0	1.2	55.5	1.1	52.0	0.9
	0.4	0.77°	596	58.6	1.2	55.5	1.1	52.0	0.9
	0.8	0.77°	596	57.8	1.2	55.5	1.1	52.0	0.9
	1.0	0.77°	596	57.4	1.2	55.5	1.1	52.0	0.9
	1.2	0.77°	596	57.0	1.1	55.5	1.1	52.0	0.9
	1.6	0.77°	596	56.2	1.1	55.5	1.1	52.0	0.9
32	0.2	0.71°	646	62.8	1.2	59.4	1.1	56.0	0.9
	0.4	0.71°	646	62.4	1.2	59.4	1.1	56.0	0.9
	0.8	0.71°	646	61.6	1.2	59.4	1.1	56.0	0.9
	1.0	0.71°	646	61.2	1.1	59.4	1.1	56.0	0.9
	1.2	0.71°	646	60.8	1.1	59.4	1.1	56.0	0.9
	1.6	0.71°	646	60.0	1.1	59.4	1.1	56.0	0.9

Note 1) When machining a highly ductile work material with the ramping angles in the table above, chips may be elongated.

* Shows the distance until a maximum depth of cut of 8 mm is achieved at the maximum ramping angle $L (= 8/\tan \alpha)$.

■ Ramping / Helical Cutting

● Ramping

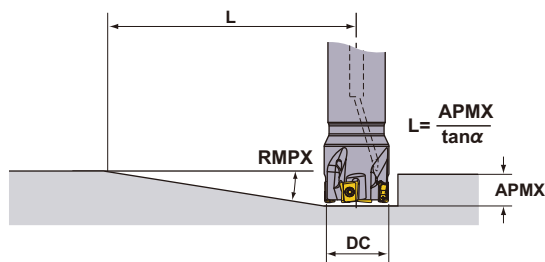

● Helical Cutting

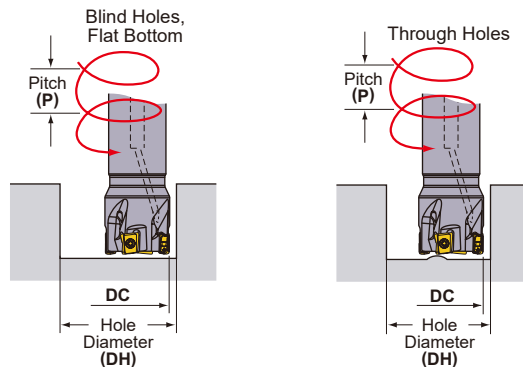

Refer to the table below for cutting conditions. For feed per tooth and cutting speed, follow the cutting conditions for slot milling.

DC (mm)	RE (mm)	Ramping		Helical Cutting (Blind Hole, Flat Bottom)				Helical Cutting (Through Hole)	
		RMPX	L (mm) *	DH max. (mm)	P max. (mm)	DH min. (mm)	P max. (mm)	DH min. (mm)	P max. (mm)
35	0.2	0.63°	728	69.0	1.2	65.5	1.1	62.0	0.9
	0.4	0.63°	728	68.6	1.2	65.5	1.1	62.0	0.9
	0.8	0.63°	728	67.8	1.1	65.5	1.1	62.0	0.9
	1.0	0.63°	728	67.4	1.1	65.5	1.1	62.0	0.9
	1.2	0.63°	728	67.0	1.1	65.5	1.1	62.0	0.9
	1.6	0.63°	728	66.2	1.1	65.5	1.1	62.0	0.9
40	0.2	0.54°	849	78.8	1.2	75.4	1.0	72.0	0.9
	0.4	0.54°	849	78.4	1.1	75.4	1.0	72.0	0.9
	0.8	0.54°	849	77.6	1.1	75.4	1.0	72.0	0.9
	1.0	0.54°	849	77.2	1.1	75.4	1.0	72.0	0.9
	1.2	0.54°	849	76.8	1.1	75.4	1.0	72.0	0.9
	1.6	0.54°	849	76.0	1.1	75.4	1.0	72.0	0.9
50	0.2	0.42°	1092	98.8	1.1	95.4	1.0	92.0	1.0
	0.4	0.42°	1092	98.4	1.1	95.4	1.0	92.0	1.0
	0.8	0.42°	1092	97.6	1.1	95.4	1.0	92.0	1.0
	1.0	0.42°	1092	97.2	1.1	95.4	1.0	92.0	1.0
	1.2	0.42°	1092	96.8	1.1	95.4	1.0	92.0	1.0
	1.6	0.42°	1092	96.0	1.1	95.4	1.0	92.0	1.0
63	0.2	0.32°	1433	124.8	1.1	121.4	1.0	118.0	1.0
	0.4	0.32°	1433	124.4	1.1	121.4	1.0	118.0	1.0
	0.8	0.32°	1433	123.6	1.1	121.4	1.0	118.0	1.0
	1.0	0.32°	1433	123.2	1.1	121.4	1.0	118.0	1.0
	1.2	0.32°	1433	122.8	1.1	121.4	1.0	118.0	1.0
	1.6	0.32°	1433	122.0	1.0	121.4	1.0	118.0	1.0

Note 1) When machining a highly ductile work material with the ramping angles in the table above, chips may be elongated.

* Shows the distance until a maximum depth of cut of 8 mm is achieved at the maximum ramping angle $L (= 8/\tan \alpha)$.

■ For Plunging and Drilling

See the tables to the right for cutting conditions. Follow the cutting conditions for slot milling regarding feed per tooth and cutting speed.

● Plunging

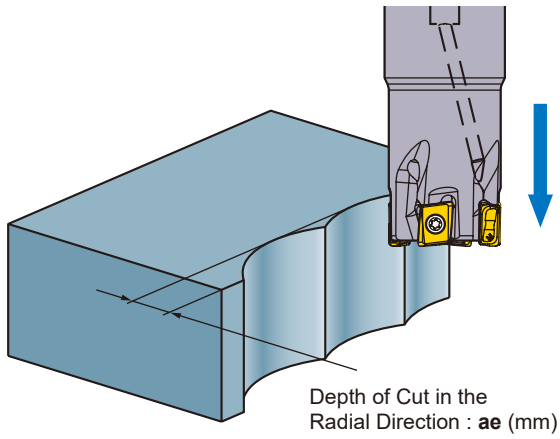

DC (mm)	ae max. (mm)
16	3.9
18	3.9
20	3.9
22	4.0
25	4.0
28	4.0
30	4.0
32	4.0
35	4.0
40	4.0
50	4.0
63	4.0

Note 1) No step feed necessary.

● Drilling

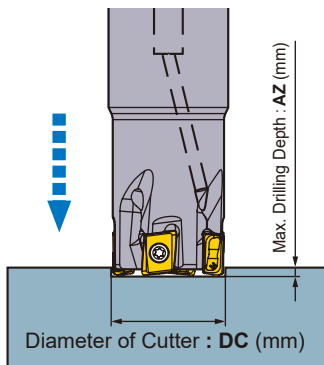

DC (mm)	AZ max. (mm)
16	0.3
18	0.3
20	0.3
22	0.3
25	0.3
28	0.3
30	0.3
32	0.3
35	0.3
40	0.3
50	0.3
63	0.3

Note 1) Exercise due caution as chips scatter easily.

Note 2) Use compressed air to eliminate chips (or coolant for when machining aluminium alloy).

ROTATING TOOLS

MULTI-FUNCTIONAL MILLING



VPX300

- P
- M
- K
- N
- S
- H

K

ROTATING TOOLS

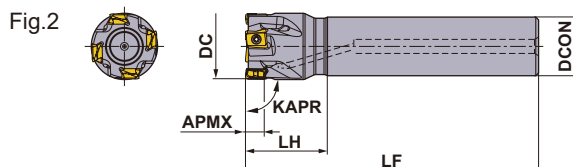
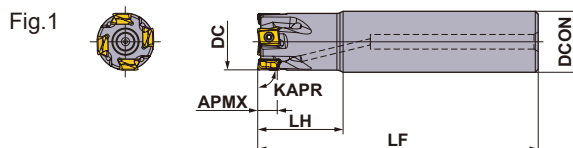

Right hand tool holder only.

■ CYLINDRICAL SHANK

With Coolant Hole

DC (mm)	Order Number	Stock R	Number of Teeth	Dimensions (mm)			APMX (mm)	RMPX	RPMX (min ⁻¹)	WT* (kg)	Fig.	Insert Type
				DCON	LF	LH						
25	VPX300R2502SA25S	●	2	25	115	35	11	2.13°	24100	0.38	1	LOGU12
25	VPX300R2502SA25L	●	2	25	170	70	11	2.13°	24100	0.56	1	LOGU12
28	VPX300R2802SA25S	★	2	25	115	35	11	1.77°	22500	0.40	2	LOGU12
28	VPX300R2802SA25L	★	2	25	170	35	11	1.77°	22500	0.60	2	LOGU12
30	VPX300R3002SA25S	★	2	25	125	35	11	1.61°	21500	0.45	2	LOGU12
30	VPX300R3003SA25S	★	3	25	125	35	11	1.61°	21500	0.44	2	LOGU12
32	VPX300R3202SA32S	●	2	32	125	45	11	1.47°	20600	0.69	1	LOGU12
32	VPX300R3203SA32S	●	3	32	125	45	11	1.47°	20600	0.68	1	LOGU12
32	VPX300R3203SA32L	●	3	32	190	90	11	1.47°	20600	1.04	1	LOGU12
35	VPX300R3503SA32L	★	3	32	190	45	11	1.28°	19500	1.10	2	LOGU12
40	VPX300R4003SA32S	●	3	32	125	45	11	1.06°	17900	0.76	2	LOGU12
40	VPX300R4004SA32S	●	4	32	125	45	11	1.06°	17900	0.76	2	LOGU12
50	VPX300R5004SA32S	★	4	32	125	45	11	0.79°	15500	0.89	2	LOGU12
50	VPX300R5006SA32S	★	6	32	125	45	11	0.79°	15500	0.88	2	LOGU12

Note 1) The maximum spindle speeds are set to ensure tool and insert stability.

Note 2) When using the tool at high spindle speeds, ensure that the tool and arbor are correctly balanced.

* WT : Tool Weight

● : Inventory maintained. ★ : Inventory maintained in Japan.



Fig.1

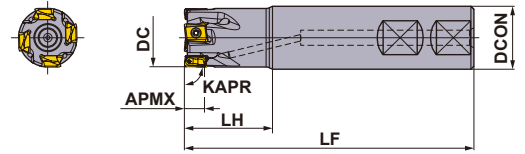

Right hand tool holder only.

WELDON SHANK TYPE

With Coolant Hole

DC (mm)	Order Number	Stock	Number of Teeth	Dimensions (mm)			APMX (mm)	RMPX	RPMX (min ⁻¹)	WT* (kg)	Fig.	Insert Type
		R		DCON	LF	LH						
25	VPX300R2502WA25S	●	2	25	91	35	11	2.13°	24100	0.29	1	LOGU12
32	VPX300R3202WA32S	●	2	32	105	45	11	1.47°	20600	0.56	1	LOGU12
32	VPX300R3203WA32S	●	3	32	105	45	11	1.47°	20600	0.55	1	LOGU12

Note 1) The maximum spindle speeds are set to ensure tool and insert stability.

Note 2) When using the tool at high spindle speeds, ensure that the tool and arbor are correctly balanced.

* WT : Tool Weight

ROTATING TOOLS

K

ROTATING TOOLS

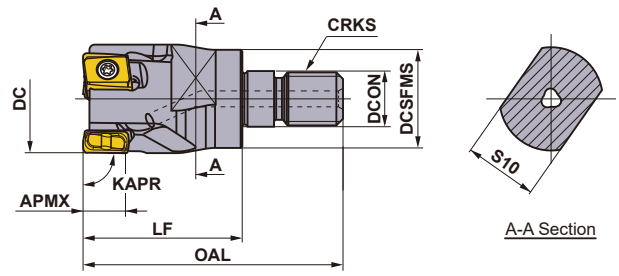
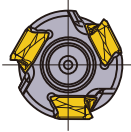

Right hand tool holder only.

SCREW-IN TYPE



With Coolant Hole

DC (mm)	Order Number	Stock R	Number of Teeth	Dimensions (mm)						WT* (kg)	APMX (mm)	RMPX	Insert Type
				DCON	DCSFMS	OAL	LF	S10	CRKS				
25	VPX300R2502AM1235	●	2	12.5	23.5	57	35	19	M12	0.10	11	2.13°	LOGU12
28	VPX300R2802AM1235	★	2	12.5	23.5	57	35	19	M12	0.12	11	1.77°	LOGU12
32	VPX300R3202AM1640	●	2	17.0	28.5	63	40	24	M16	0.20	11	1.47°	LOGU12
32	VPX300R3203AM1640	●	3	17.0	28.5	63	40	24	M16	0.19	11	1.47°	LOGU12
35	VPX300R3502AM1640	★	2	17.0	28.5	63	40	24	M16	0.22	11	1.28°	LOGU12
35	VPX300R3503AM1640	★	3	17.0	28.5	63	40	24	M16	0.22	11	1.28°	LOGU12
40	VPX300R4003AM1640	●	3	17.0	28.5	63	40	24	M16	0.26	11	1.06°	LOGU12
40	VPX300R4004AM1640	●	4	17.0	28.5	63	40	24	M16	0.26	11	1.06°	LOGU12

Note 1) For screw-in type arbors, refer to K244.

* WT : Tool Weight

SPARE PARTS

DC (mm)	Tool Holder Type	*		
				
		Clamp Screw	Wrench	Anti-seize Lubricant
25	VPX300R25	TPS40F1	TIP15W	MK1KS
28	VPX300R28	TPS40F1	TIP15W	MK1KS
30	VPX300R30	TPS40F1	TIP15W	MK1KS
32	VPX300R32	TPS40F1	TIP15W	MK1KS
35	VPX300R35	TPS40F1	TIP15W	MK1KS
40	VPX300R40	TPS40F1	TIP15W	MK1KS
50	VPX300R50	TPS40F1	TIP15W	MK1KS

* Clamp Torque (N · m) : TPS40F1=3.0

● : Inventory maintained. ★ : Inventory maintained in Japan.

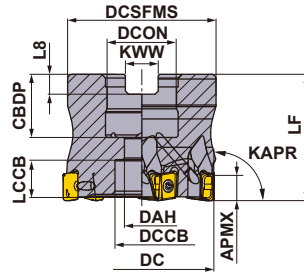

DC (mm)	Set Bolt	Geometry
φ40	HSC08025H	
φ50, φ63	HSC10030H	
φ80	HSC12035H	

ARBOR TYPE

KAPR: 90°
GAMP: -6° GAMF: -22.5°
With Coolant Hole

Right hand tool holder only.

DC (mm)	Order Number	Stock	Number of Teeth	Dimensions (mm)		WT* (kg)	APMX (mm)	RMPX	RPMX (min ⁻¹)	Insert Type
		R		LF	DCON					
40	VPX300-040A03AR	●	3	40	16	0.21	11	1.06°	17900	LOGU12
40	VPX300-040A04AR	●	4	40	16	0.21	11	1.06°	17900	LOGU12
50	VPX300-050A04AR	●	4	40	22	0.34	11	0.79°	15500	LOGU12
50	VPX300-050A06AR	●	6	40	22	0.33	11	0.79°	15500	LOGU12
63	VPX300-063A06AR	●	6	40	22	0.61	11	0.60°	13400	LOGU12
63	VPX300-063A08AR	●	8	40	22	0.62	11	0.60°	13400	LOGU12
80	VPX300-080A07AR	●	7	50	27	0.99	11	0.45°	11500	LOGU12
80	VPX300-080A10AR	●	10	50	27	0.99	11	0.45°	11500	LOGU12

Note 1) The maximum spindle speeds are set to ensure tool and insert stability.

Note 2) When using the tool at high spindle speeds, ensure that the tool and arbor are correctly balanced.

* WT : Tool Weight

MOUNTING DIMENSIONS

DC (mm)	Order Number	Dimensions (mm)							
		DCON	CBDP	DAH	DCCB	LCCB	DCSFMS	KWW	L8
40	VPX300-040A03AR	16	18	9	14	12.4	37	8.4	5.6
40	VPX300-040A04AR	16	18	9	14	12.4	37	8.4	5.6
50	VPX300-050A04AR	22	20	11	17	10.4	47	10.4	6.3
50	VPX300-050A06AR	22	20	11	17	10.4	47	10.4	6.3
63	VPX300-063A06AR	22	20	11	17	10.4	60	10.4	6.3
63	VPX300-063A08AR	22	20	11	17	10.4	60	10.4	6.3
80	VPX300-080A07AR	27	23	13	20	13.4	56	12.4	7.0
80	VPX300-080A10AR	27	23	13	20	13.4	56	12.4	7.0

SPARE PARTS

Tool Holder Type	*		
	Clamp Screw	Wrench	Anti-seize Lubricant
VPX300	TPS40F1	TIP15W	MK1KS

* Clamp Torque (N · m) : TPS40F1 = 3.0

ARBORS	> K244
SPARE PARTS	> N001
TECHNICAL DATA	> P001

ROTATING TOOLS

INSERTS

ROTATING TOOLS

K

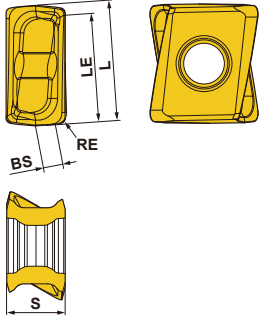
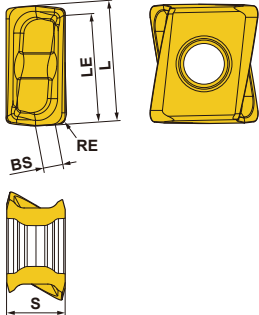
Work Material	P	Steels											Cutting Conditions (Guide) :						
	M	Stainless Steels											● : Stable Cutting ● : General Cutting ✦ : Unstable Cutting						
	K	Cast Irons											Honing :						
N	Non-ferrous Metals											E : Round F : Sharp							
S	Heat Resistant Alloys, Titanium Alloys																		
H	Hardened Steels																		
Shape	Order Number	Class	Honing	Coated							Carbide	Dimensions (mm)					Geometry		
				MC5020	MP6120	MP6130	MP7130	MP9120	MP9130	VP15TF	TF15	L	RE	LE	S	BS			
Low Cutting Resistance L Breaker	LOGU1207020PNER-L	G E	★	★	★	★	★	★	★	★	★	★		12.4	0.2	11.3	7.0	3.0	
	LOGU1207040PNER-L	G E	●	●	●	●	●	●	●	●	★		12.4	0.4	11.3	7.0	2.8		
	LOGU1207080PNER-L	G E	●	●	●	●	●	●	●	●	★		12.4	0.8	11.3	7.0	2.6		
	LOGU1207100PNER-L	G E	★	★	★	★	★	★	★	★			12.4	1.0	11.3	7.0	2.5		
	LOGU1207120PNER-L	G E	●	●	●	●	●	●	●	●	★		12.4	1.2	11.3	7.0	2.4		
	LOGU1207160PNER-L	G E	●	●	●	●	●	●	●	●	★		12.4	1.6	11.3	7.0	1.8		
	LOGU1207200PNER-L	G E	●	●	●	●	●	●	●	●	★		12.4	2.0	11.3	7.0	1.4		
	LOGU1207240PNER-L	G E	●	●	●	●	●	●	●	●	★		12.4	2.4	11.3	7.0	1.2		
	LOGU1207300PNER-L	G E	★	★	★	★	★	★	★	★			12.4	3.0	11.3	7.0	0.6		
	LOGU1207320PNER-L	G E	●	●	●	●	●	●	●	●	★		12.4	3.2	11.3	7.0	0.4		
	LOGU1207020PNFR-L	G F									★		12.4	0.2	11.3	7.0	3.0		
	LOGU1207040PNFR-L	G F									●		12.4	0.4	11.3	7.0	2.8		
	LOGU1207080PNFR-L	G F									●		12.4	0.8	11.3	7.0	2.6		
	LOGU1207100PNFR-L	G F									★		12.4	1.0	11.3	7.0	2.5		
	LOGU1207120PNFR-L	G F									●		12.4	1.2	11.3	7.0	2.4		
	LOGU1207160PNFR-L	G F									●		12.4	1.6	11.3	7.0	1.8		
	LOGU1207200PNFR-L	G F									●		12.4	2.0	11.3	7.0	1.4		
	LOGU1207240PNFR-L	G F									●		12.4	2.4	11.3	7.0	1.2		
	LOGU1207300PNFR-L	G F									★		12.4	3.0	11.3	7.0	0.6		
	LOGU1207320PNFR-L	G F									●		12.4	3.2	11.3	7.0	0.4		
General Use M Breaker	LOGU1207020PNER-M	G E	★	★	★	★	★	★	★	★	★		12.4	0.2	11.3	7.0	3.0		
	LOGU1207040PNER-M	G E	●	●	●	●	●	●	●	●	★		12.4	0.4	11.3	7.0	2.8		
	LOGU1207080PNER-M	G E	●	●	●	●	●	●	●	●	★		12.4	0.8	11.3	7.0	2.4		
	LOGU1207100PNER-M	G E	★	★	★	★	★	★	★	★			12.4	1.0	11.3	7.0	2.3		
	LOGU1207120PNER-M	G E	●	●	●	●	●	●	●	●	★		12.4	1.2	11.3	7.0	2.1		
	LOGU1207160PNER-M	G E	●	●	●	●	●	●	●	●	★		12.4	1.6	11.3	7.0	1.7		
	LOGU1207200PNER-M	G E	●	●	●	●	●	●	●	●	★		12.4	2.0	11.3	7.0	1.4		
	LOGU1207240PNER-M	G E	●	●	●	●	●	●	●	●	★		12.4	2.4	11.3	7.0	1.0		
	LOGU1207300PNER-M	G E	★	★	★	★	★	★	★	★			12.4	3.0	11.3	7.0	0.5		
	LOGU1207320PNER-M	G E	●	●	●	●	●	●	●	●	★		12.4	3.2	11.3	7.0	0.3		
	LOGU1207020PNFR-M	G F									★		12.4	0.2	11.3	7.0	3.0		
	LOGU1207040PNFR-M	G F									●		12.4	0.4	11.3	7.0	2.8		
	LOGU1207080PNFR-M	G F									●		12.4	0.8	11.3	7.0	2.4		
	LOGU1207100PNFR-M	G F									★		12.4	1.0	11.3	7.0	2.3		
	LOGU1207120PNFR-M	G F									●		12.4	1.2	11.3	7.0	2.1		
	LOGU1207160PNFR-M	G F									●		12.4	1.6	11.3	7.0	1.7		
	LOGU1207200PNFR-M	G F									●		12.4	2.0	11.3	7.0	1.4		
	LOGU1207240PNFR-M	G F									●		12.4	2.4	11.3	7.0	1.0		
	LOGU1207300PNFR-M	G F									★		12.4	3.0	11.3	7.0	0.5		
	LOGU1207320PNFR-M	G F									●		12.4	3.2	11.3	7.0	0.3		

Right hand insert only.

Right hand insert only.

● ★ = NEW

● : Inventory maintained. ★ : Inventory maintained in Japan.
(10 inserts in one case)

Cutting Conditions (Guide) :

● : Stable Cutting ● : General Cutting ✖ : Unstable Cutting

CHIPBREAKER RECOMMENDATION

Chipbreaker Selection Table

Work Material	Properties	Cutting Conditions	Chipbreaker		Grade		
			1st Recommendation	2nd Recommendation	1st Recommendation	2nd Recommendation	
P Mild Steel	Hardness ≤180HB	● ●	L	M	MP6120	VP15TF	
		✖	M	L	MP6130	—	
	Carbon Steel Alloy Steel Alloy Tool Steel (Annealing)	Hardness 180-350HB ≤350HB	● ●	L	M	MP6120	VP15TF
			● ●	M	L	MP6120	VP15TF
		Hardness ≤350HB (Annealing)	✖	M	L	MP6130	—
			● ●	M	L	MP6120	VP15TF
Pre-hardened Steel	Hardness 35—45HRC	● ●	M	L	MP6120	VP15TF	
		✖	M	L	MP6130	—	
M Austenitic Stainless Steel	Hardness ≤280HB	● ●	L	M	MP7130	VP15TF	
		✖	M	L	MP7130	—	
	Hardness >200HB	● ●	L	M	MP7130	VP15TF	
		✖	M	L	MP7130	—	
	Duplex Stainless Steel	Hardness ≤280HB	● ●	L	M	MP7130	VP15TF
			✖	M	L	MP7130	—
	Ferritic and Martensitic Stainless Steel	—	● ●	L	M	MP7130	VP15TF
			✖	M	L	MP7130	—
	Precipitation Hardening Stainless Steel	Hardness <450HB	● ●	L	M	MP7130	VP15TF
			✖	M	L	MP7130	—
	K Gray Cast Iron	Tensile Strength ≤350MPa	● ●	M	L	MC5020	VP15TF
			✖	M	L	VP15TF	—
Ductile Cast Iron		Tensile Strength ≤800MPa	● ●	M	L	MC5020	VP15TF
			✖	M	L	VP15TF	—
N Aluminium Alloy	Content Si <5%	● ●	L	M	TF15	—	
		✖	M	L	TF15	—	
S Titanium Alloy (Ti-6Al-4V, etc.)	—	● ●	L	M	MP9120	VP15TF	
		✖	M	L	MP9130	—	
	Titanium Alloy (Ti-5Al-5V-5Mo-3Cr, etc.)	—	● ●	L	M	MP9120	VP15TF
			✖	M	L	MP9130	—
	Heat Resistant Alloy	—	● ●	M	L	MP9120	VP15TF
			✖	M	L	MP9130	—
H Hardened Steel	Hardness 40—55HRC	● ● ✖	M	—	VP15TF	—	

K
ROTATING TOOLS

ROTATING TOOLS

RECOMMENDED CUTTING CONDITIONS

■ Dry Cutting Cutting Speed

Work Material	Properties	Cutting Conditions	Insert Grade	ae (mm)			
				≤0.25DC	0.25—0.5DC	0.5—0.75DC	DC(Slot)
				Vc (m/min)			
P Mild Steel	Hardness ≤180HB	● ●	MP6120, VP15TF	230 (180—270)	220 (170—260)	180 (140—210)	180 (140—210)
		● ●	MP6130	200 (150—240)	190 (170—260)	150 (110—180)	150 (110—180)
	Hardness 180—350HB ≤350HB (Annealing)	● ●	MP6120, VP15TF	180 (140—210)	170 (130—200)	140 (110—160)	140 (110—180)
		● ●	MP6130	150 (110—180)	140 (100—170)	110 (80—130)	110 (80—130)
Pre-hardened Steel	Hardness 35—45HRC	● ●	MP6120, VP15TF	120 (90—140)	110 (80—130)	100 (70—120)	100 (70—120)
		● ●	MP6130	100 (80—120)	90 (70—110)	80 (60—100)	80 (60—100)
M Austenitic Stainless Steel	Hardness ≤200HB	● ● ●	MP7130, VP15TF	180 (140—210)	170 (130—200)	140 (110—160)	140 (110—160)
		● ● ●	MP7130, VP15TF	150 (110—180)	140 (100—160)	110 (80—130)	110 (80—130)
	Hardness >200HB	● ● ●	MP7130, VP15TF	140 (110—170)	130 (90—150)	100 (70—120)	100 (70—120)
		● ● ●	MP7130, VP15TF	180 (140—210)	170 (130—200)	140 (110—160)	140 (110—160)
		● ● ●	MP7130, VP15TF	130 (100—160)	120 (80—140)	90 (60—110)	90 (60—110)
K Gray Cast Iron	Tensile Strength ≤350MPa	● ●	MC5020	250 (200—300)	240 (190—290)	210 (160—260)	210 (160—260)
		● ●	VP15TF	200 (150—250)	190 (140—240)	160 (110—210)	160 (110—210)
Ductile Cast Iron	Tensile Strength ≤800MPa	● ●	MC5020	180 (150—200)	170 (140—190)	150 (120—170)	150 (120—170)
		● ●	VP15TF	130 (100—150)	120 (90—140)	100 (80—120)	100 (80—120)
N Aluminium Alloy	Content Si <5%	● ● ●	TF15	600 (400—1000)	600 (400—1000)	600 (400—1000)	600 (400—1000)
H Hardened Steel	Hardness 40—55HRC	● ● ●	VP15TF	90 (70—100)	85 (60—100)	70 (50—80)	70 (50—80)

Note 1) These cutting conditions should be referenced for standard shank types (last letter in designation is S) and arbor shank types. If there is chatter, insert chipping, etc. during machining, alter conditions accordingly.

Note 2) Chattering and vibrations are more likely under the following circumstances. Use a cut and feed per tooth that are at minimum recommended conditions or below.

- When tool overhang is long (using a long shank, screw-in type, etc.)
- Rigidity of machine, work material or attachment of work material is low
- At a corner radius during pocket milling

Note 3) A type with fewer teeth is recommended when the depth of cut in the radial direction (ae) is 0.5 DC or more.

Note 4) Wet cutting is recommended, when focusing on the surface finish. (Service life is shorter than for dry cutting.)

Note 5) When using higher than recommended cutting conditions, or for long periods of time, the clamp screw may become fatigued and break during machining. Please change out the clamp screw periodically.

Depth of Cut / Feed per Tooth

Work Material	Properties	ae (mm)	Cutting Conditions	DC (mm)			
				ø25		ø28—ø80	
				ap (mm)	fz (mm/t.)	ap (mm)	fz (mm/t.)
P Mild Steel	Hardness ≤180HB	≤0.25DC	● ● ●	≤11	0.10—0.20	≤11	0.10—0.30
		0.25—0.5DC	● ● ●	≤11	0.10—0.15	≤11	0.10—0.25
		0.5—0.75DC	● ● ●	≤8	0.08—0.12	≤8	0.10—0.20
		DC(Slot)	● ● ●	≤5	0.06—0.10	≤5	0.08—0.15
Carbon Steel Alloy Steel Alloy Tool Steel	Hardness 180—280HB	≤0.25DC	● ● ●	≤11	0.10—0.20	≤11	0.10—0.30
		0.25—0.5DC	● ● ●	≤11	0.10—0.15	≤11	0.10—0.25
		0.5—0.75DC	● ● ●	≤8	0.08—0.12	≤8	0.10—0.20
		DC(Slot)	● ● ●	≤5	0.06—0.10	≤5	0.08—0.15
Carbon Steel Alloy Steel Alloy Tool Steel	Hardness 280—350HB ≤350HB (Annealing)	≤0.25DC	● ● ●	≤11	0.10—0.15	≤11	0.10—0.25
		0.25—0.5DC	● ● ●	≤11	0.08—0.12	≤11	0.10—0.20
		0.5—0.75DC	● ● ●	≤8	0.06—0.10	≤8	0.10—0.15
		DC(Slot)	● ● ●	≤5	0.06—0.10	≤5	0.08—0.12
Pre-hardened Steel	Hardness 35—45HRC	≤0.25DC	● ● ●	≤11	0.10—0.15	≤11	0.10—0.25
		0.25—0.5DC	● ● ●	≤11	0.08—0.12	≤11	0.10—0.20
		0.5—0.75DC	● ● ●	≤8	0.06—0.10	≤8	0.10—0.15
		DC(Slot)	● ● ●	≤5	0.06—0.10	≤5	0.08—0.12

Cutting Conditions (Guide) :

● : Stable Cutting ● : General Cutting ✖ : Unstable Cutting

Depth of Cut / Feed per Tooth

Work Material	Properties	ae (mm)	Cutting Conditions	DC (mm)				
				ø25		ø28-ø80		
				ap (mm)	fz (mm/t.)	ap (mm)	fz (mm/t.)	
M	Austenitic Stainless Steel	≤0.25DC	● ● ✖	≤11	0.10-0.20	≤11	0.10-0.20	
			● ● ✖	≤11	0.08-0.15	≤11	0.08-0.15	
		0.25-0.5DC	● ● ✖	≤11	0.08-0.15	≤11	0.08-0.15	
			● ● ✖	≤11	0.08-0.12	≤11	0.08-0.12	
	0.5-0.75DC	● ● ✖	≤8	0.08-0.12	≤8	0.08-0.12		
		● ● ✖	≤8	0.06-0.10	≤8	0.06-0.10		
	DC(Slot)	● ● ✖	≤5	0.06-0.10	≤5	0.06-0.10		
		● ● ✖	≤5	0.06-0.08	≤5	0.06-0.08		
	Duplex Stainless Steel	Hardness ≤280HB	≤0.25DC	● ● ✖	≤11	0.10-0.20	≤11	0.10-0.20
				● ● ✖	≤11	0.08-0.15	≤11	0.08-0.15
			0.25-0.5DC	● ● ✖	≤11	0.08-0.15	≤11	0.08-0.15
				● ● ✖	≤11	0.08-0.12	≤11	0.08-0.12
	0.5-0.75DC	● ● ✖	≤8	0.08-0.12	≤8	0.08-0.12		
		● ● ✖	≤8	0.06-0.10	≤8	0.06-0.10		
	DC(Slot)	● ● ✖	≤5	0.06-0.10	≤5	0.06-0.10		
		● ● ✖	≤5	0.06-0.08	≤5	0.06-0.08		
Ferritic and Martensitic Stainless Steel	-	≤0.25DC	● ● ✖	≤11	0.10-0.20	≤11	0.10-0.20	
			● ● ✖	≤11	0.08-0.15	≤11	0.08-0.15	
		0.25-0.5DC	● ● ✖	≤11	0.08-0.15	≤11	0.08-0.15	
			● ● ✖	≤11	0.08-0.12	≤11	0.08-0.12	
0.5-0.75DC	● ● ✖	≤8	0.08-0.12	≤8	0.08-0.12			
	● ● ✖	≤8	0.06-0.10	≤8	0.06-0.10			
DC(Slot)	● ● ✖	≤5	0.06-0.10	≤5	0.06-0.10			
	● ● ✖	≤5	0.06-0.08	≤5	0.06-0.08			
Precipitation Hardening Stainless Steel	Hardness <450HB	≤0.25DC	● ● ✖	≤11	0.10-0.15	≤11	0.10-0.15	
			● ● ✖	≤11	0.08-0.12	≤11	0.08-0.12	
		0.25-0.5DC	● ● ✖	≤11	0.08-0.12	≤11	0.08-0.12	
			● ● ✖	≤11	0.08-0.12	≤11	0.06-0.10	
0.5-0.75DC	● ● ✖	≤8	0.06-0.10	≤8	0.06-0.10			
	● ● ✖	≤8	0.06-0.08	≤8	0.06-0.08			
DC(Slot)	● ● ✖	≤5	0.06-0.10	≤5	0.06-0.10			
	● ● ✖	≤5	0.06-0.08	≤5	0.06-0.08			
K	Gray Cast Iron	≤0.25DC	● ● ✖	≤11	0.10-0.20	≤11	0.10-0.30	
			● ● ✖	≤11	0.08-0.15	≤11	0.10-0.25	
		0.25-0.5DC	● ● ✖	≤11	0.08-0.15	≤11	0.10-0.25	
			● ● ✖	≤11	0.08-0.12	≤11	0.10-0.20	
	0.5-0.75DC	● ● ✖	≤8	0.08-0.12	≤8	0.10-0.20		
		● ● ✖	≤8	0.06-0.10	≤8	0.08-0.15		
	DC(Slot)	● ● ✖	≤5	0.06-0.10	≤5	0.08-0.15		
		● ● ✖	≤5	0.06-0.08	≤5	0.08-0.12		
Ductile Cast Iron	Tensile Strength ≤800MPa	≤0.25DC	● ● ✖	≤11	0.10-0.20	≤11	0.10-0.25	
			● ● ✖	≤11	0.10-0.15	≤11	0.10-0.20	
		0.25-0.5DC	● ● ✖	≤11	0.10-0.15	≤11	0.10-0.20	
			● ● ✖	≤11	0.08-0.12	≤11	0.10-0.15	
0.5-0.75DC	● ● ✖	≤8	0.08-0.12	≤8	0.10-0.15			
	● ● ✖	≤8	0.08-0.12	≤8	0.08-0.12			
DC(Slot)	● ● ✖	≤5	0.06-0.10	≤5	0.08-0.12			
	● ● ✖	≤5	0.06-0.08	≤5	0.06-0.10			
N	Aluminium Alloy	≤0.25DC	● ● ✖	≤11	0.10-0.25	≤11	0.10-0.25	
			● ● ✖	≤11	0.10-0.20	≤11	0.10-0.20	
		0.25-0.5DC	● ● ✖	≤11	0.10-0.20	≤11	0.10-0.20	
			● ● ✖	≤11	0.10-0.15	≤11	0.10-0.15	
		0.5-0.75DC	● ● ✖	≤8	0.06-0.15	≤8	0.08-0.15	
			● ● ✖	≤8	0.06-0.15	≤8	0.08-0.15	
		DC(Slot)	● ● ✖	≤5	0.06-0.15	≤5	0.08-0.15	
			● ● ✖	≤5	0.06-0.15	≤5	0.08-0.12	
H	Hardened Steel	≤0.25DC	● ● ✖	≤5	0.08-0.15	≤5	0.08-0.15	
			● ● ✖	≤5	0.08-0.12	≤5	0.08-0.12	
		0.25-0.5DC	● ● ✖	≤4	0.08-0.12	≤4	0.08-0.12	
			● ● ✖	≤4	0.06-0.10	≤4	0.06-0.10	
		0.5-0.75DC	● ● ✖	≤3	0.06-0.10	≤3	0.06-0.10	
			● ● ✖	≤3	0.06-0.08	≤3	0.06-0.08	
		DC(Slot)	● ● ✖	≤2	0.06-0.10	≤2	0.06-0.10	
			● ● ✖	≤2	0.06-0.08	≤2	0.06-0.08	

Note 1) These cutting conditions should be referenced for standard shank types (last letter in designation is S) and arbor shank types.

If there is chatter, insert chipping, etc. during machining, alter conditions accordingly.

Note 2) Chattering and vibrations are more likely under the following circumstances. Use a cut and feed per tooth that are at minimum recommended conditions or below.

- When tool overhang is long (using a long shank, screw-in type, etc.)
- Rigidity of machine, work material or attachment of work material is low
- At a corner radius during pocket milling

Note 3) A type with fewer teeth is recommended when the depth of cut in the radial direction (ae) is 0.5 DC or more.

Note 4) Wet cutting is recommended, when focusing on the surface finish. (Service life is shorter than for dry cutting.)

Note 5) When using higher than recommended cutting conditions, or for long periods of time, the clamp screw may become fatigued and break during machining. Please change out the clamp screw periodically.

K

ROTATING TOOLS

ROTATING TOOLS

RECOMMENDED CUTTING CONDITIONS

Wet Cutting Cutting Speed

Work Material	Properties	Cutting Conditions	Insert Grade	ae (mm)							
				≤0.25DC	0.25—0.5DC	0.5—0.75DC	DC(Slot)				
				Vc (m/min)							
P Mild Steel	Hardness ≤180HB	● ● ✖	MP6120 MP6130 VP15TF	140 (100—190)	130 (90—180)	100 (70—120)	100 (70—120)				
				Carbon Steel Alloy Steel Alloy Tool Steel	Hardness 180—350HB ≤350HB (Annealing)	● ● ✖	MP6120 MP6130 VP15TF	120 (90—140)	110 (80—130)	100 (70—120)	100 (70—120)
								Pre-hardened Steel	Hardness 35—45HRC	● ● ✖	MP6120 MP6130 VP15TF
M Austenitic Stainless Steel	Hardness ≤200HB	● ● ✖	MP7130, VP15TF	120 (100—150)	110 (90—140)	90 (70—120)	90 (70—120)				
				Hardness >200HB	● ● ✖	MP7130, VP15TF	100 (80—130)	90 (70—120)	70 (50—100)	70 (50—100)	
	Duplex Stainless Steel	Hardness ≤280HB	● ● ✖	MP7130, VP15TF	100 (80—130)	90 (70—120)	70 (50—100)	70 (50—100)			
	Ferritic and Martensitic Stainless Steel	—	● ● ✖	MP7130, VP15TF	120 (100—150)	110 (90—140)	90 (70—120)	90 (70—120)			
	Precipitation Hardening Stainless Steel	Hardness <450HB	● ● ✖	MP7130, VP15TF	90 (70—120)	80 (60—110)	60 (40—90)	60 (40—90)			
K Gray Cast Iron	Tensile Strength ≤350MPa	● ● ✖	MC5020	180 (160—220)	170 (150—210)	150 (130—190)	150 (130—190)				
		● ● ✖	VP15TF	130 (100—150)	120 (90—140)	100 (80—120)	100 (80—120)				
	Ductile Cast Iron	Tensile Strength ≤800MPa	● ● ✖	MC5020	160 (140—180)	150 (130—170)	130 (110—150)	130 (110—150)			
			● ● ✖	VP15TF	110 (80—140)	100 (70—130)	80 (60—120)	80 (60—120)			
N Aluminium Alloy	Content Si <5%	● ● ✖	TF15	600 (400—1000)	600 (400—1000)	600 (400—1000)	600 (400—1000)				
S Titanium Alloy (Ti-6Al-4V, etc.)	—	● ● ✖	MP9120, VP15TF	50 (40—70)	50 (40—70)	50 (40—70)	50 (40—70)				
		● ✖	MP9130	40 (30—60)	40 (30—60)	40 (30—60)	40 (30—60)				
	Titanium Alloy (Ti-5Al-5V-5Mo-3Cr, etc.)	—	● ● ✖	MP9120, VP15TF	30 (20—40)	30 (20—40)	30 (20—40)	30 (20—40)			
			● ✖	MP9130	30 (20—40)	30 (20—40)	30 (20—40)	30 (20—40)			
	Heat Resistant Alloy	—	● ● ✖	MP9120, VP15TF	40 (30—60)	40 (30—60)	40 (30—60)	40 (30—60)			
			● ✖	MP9130	30 (20—40)	30 (20—40)	30 (20—40)	30 (20—40)			
H Hardened Steel	Hardness 40—55HRC	● ● ✖	VP15TF	90 (70—100)	85 (60—100)	70 (50—80)	70 (50—80)				

Note 1) These cutting conditions should be referenced for standard shank types (last letter in designation is S) and arbor shank types. If there is chatter, insert chipping, etc. during machining, alter conditions accordingly.

Note 2) Chattering and vibrations are more likely under the following circumstances. Use a cut and feed per tooth that are at minimum recommended conditions or below.

- When tool overhang is long (using a long shank, screw-in type, etc.)
- Rigidity of machine, work material or attachment of work material is low
- At a corner radius during pocket milling

Note 3) A type with fewer teeth is recommended when the depth of cut in the radial direction (ae) is 0.5 DC or more.

Note 4) Wet cutting is recommended, when focusing on the surface finish. (Service life is shorter than for dry cutting.)

Note 5) When using higher than recommended cutting conditions, or for long periods of time, the clamp screw may become fatigued and break during machining. Please change out the clamp screw periodically.

Cutting Conditions (Guide) :

● : Stable Cutting ● : General Cutting ✖ : Unstable Cutting

Depth of Cut / Feed per Tooth

Work Material	Properties	ae (mm)	Cutting Conditions	DC (mm)				
				ø25		ø28-ø80		
				ap (mm)	fz (mm/t.)	ap (mm)	fz (mm/t.)	
P	Mild Steel	Hardness ≤180HB	≤0.25DC	● ● ✖	≤11	0.10-0.20	≤11	0.10-0.30
			0.25-0.5DC	● ● ✖	≤11	0.10-0.15	≤11	0.10-0.25
			0.5-0.75DC	● ● ✖	≤8	0.08-0.12	≤8	0.10-0.20
			DC(Slot)	● ● ✖	≤5	0.06-0.10	≤5	0.08-0.15
	Carbon Steel Alloy Steel Alloy Tool Steel	Hardness 180-280HB	≤0.25DC	● ● ✖	≤11	0.10-0.20	≤11	0.10-0.30
			0.25-0.5DC	● ● ✖	≤11	0.10-0.15	≤11	0.10-0.25
			0.5-0.75DC	● ● ✖	≤8	0.08-0.12	≤8	0.10-0.20
			DC(Slot)	● ● ✖	≤5	0.06-0.10	≤5	0.08-0.15
	Carbon Steel Alloy Steel Alloy Tool Steel	Hardness 280-350HB ≤350HB (Annealing)	≤0.25DC	● ● ✖	≤11	0.10-0.15	≤11	0.10-0.25
			0.25-0.5DC	● ● ✖	≤11	0.08-0.12	≤11	0.10-0.20
			0.5-0.75DC	● ● ✖	≤8	0.06-0.10	≤8	0.10-0.15
			DC(Slot)	● ● ✖	≤5	0.06-0.10	≤5	0.08-0.12
	Pre-hardened Steel	Hardness 35-45HRC	≤0.25DC	● ● ✖	≤11	0.10-0.15	≤11	0.10-0.25
			0.25-0.5DC	● ● ✖	≤11	0.08-0.12	≤11	0.10-0.20
			0.5-0.75DC	● ● ✖	≤8	0.06-0.10	≤8	0.10-0.15
			DC(Slot)	● ● ✖	≤5	0.06-0.10	≤5	0.08-0.12
M	Austenitic Stainless Steel	-	≤0.25DC	● ● ✖	≤11	0.10-0.20	≤11	0.10-0.20
				● ● ✖	≤11	0.08-0.15	≤11	0.08-0.15
			0.25-0.5DC	● ● ✖	≤11	0.08-0.12	≤11	0.08-0.15
				● ● ✖	≤11	0.06-0.10	≤11	0.08-0.12
		0.5-0.75DC	● ● ✖	≤8	0.06-0.10	≤8	0.08-0.12	
			● ● ✖	≤8	0.06-0.10	≤8	0.06-0.10	
		DC(Slot)	● ● ✖	≤5	0.06-0.10	≤5	0.06-0.10	
			● ● ✖	≤5	0.06-0.08	≤5	0.06-0.08	
	Duplex Stainless Steel	Hardness ≤280HB	≤0.25DC	● ● ✖	≤11	0.10-0.20	≤11	0.10-0.20
				● ● ✖	≤11	0.08-0.15	≤11	0.08-0.15
			0.25-0.5DC	● ● ✖	≤11	0.08-0.15	≤11	0.08-0.15
				● ● ✖	≤11	0.08-0.12	≤11	0.08-0.12
		0.5-0.75DC	● ● ✖	≤8	0.08-0.12	≤8	0.08-0.12	
			● ● ✖	≤8	0.06-0.10	≤8	0.06-0.10	
		DC(Slot)	● ● ✖	≤5	0.06-0.10	≤5	0.06-0.10	
			● ● ✖	≤5	0.06-0.08	≤5	0.06-0.08	
	Ferritic and Martensitic Stainless Steel	-	≤0.25DC	● ● ✖	≤11	0.10-0.20	≤11	0.10-0.20
				● ● ✖	≤11	0.08-0.15	≤11	0.08-0.15
			0.25-0.5DC	● ● ✖	≤11	0.08-0.15	≤11	0.08-0.15
				● ● ✖	≤11	0.08-0.12	≤11	0.08-0.12
		0.5-0.75DC	● ● ✖	≤8	0.08-0.12	≤8	0.08-0.12	
			● ● ✖	≤8	0.06-0.10	≤8	0.06-0.10	
		DC(Slot)	● ● ✖	≤5	0.06-0.10	≤5	0.06-0.10	
			● ● ✖	≤5	0.06-0.08	≤5	0.06-0.08	
Precipitation Hardening Stainless Steel	Hardness <450HB	≤0.25DC	● ● ✖	≤11	0.10-0.15	≤11	0.10-0.15	
			● ● ✖	≤11	0.08-0.12	≤11	0.08-0.12	
		0.25-0.5DC	● ● ✖	≤11	0.08-0.12	≤11	0.08-0.12	
			● ● ✖	≤11	0.08-0.12	≤11	0.08-0.12	
	0.5-0.75DC	● ● ✖	≤8	0.06-0.10	≤8	0.06-0.10		
		● ● ✖	≤8	0.06-0.08	≤8	0.06-0.08		
	DC(Slot)	● ● ✖	≤5	0.06-0.10	≤5	0.06-0.10		
		● ● ✖	≤5	0.06-0.08	≤5	0.06-0.08		

Note 1) These cutting conditions should be referenced for standard shank types (last letter in designation is S) and arbor shank types.

If there is chatter, insert chipping, etc. during machining, alter conditions accordingly.

Note 2) Chattering and vibrations are more likely under the following circumstances. Use a cut and feed per tooth that are at minimum recommended conditions or below.

- When tool overhang is long (using a long shank, screw-in type, etc.)
- Rigidity of machine, work material or attachment of work material is low
- At corner radius during pocket milling

Note 3) A type with fewer teeth is recommended when the depth of cut in the radial direction (ae) is 0.5 DC or more.

Note 4) Wet cutting is recommended, when focusing on the surface finish. (Service life is shorter than for dry cutting.)

Note 5) When using higher than recommended cutting conditions, or for long periods of time, the clamp screw may become fatigued and break during machining. Please change out the clamp screw periodically.

RECOMMENDED CUTTING CONDITIONS

Wet Cutting

Depth of Cut / Feed per Tooth

Work Material	Properties	ae (mm)	Cutting Conditions	DC (mm)				
				ø25		ø28-ø80		
				ap (mm)	fz (mm/t.)	ap (mm)	fz (mm/t.)	
K Gray Cast Iron	Tensile Strength ≤350MPa	≤0.25DC	● ● ✖	≤11	0.10-0.20	≤11	0.10-0.30	
			● ● ✖	≤11	0.08-0.15	≤11	0.10-0.25	
		0.25-0.5DC	● ● ✖	≤11	0.08-0.15	≤11	0.10-0.25	
			● ● ✖	≤11	0.08-0.12	≤11	0.10-0.20	
		0.5-0.75DC	● ● ✖	≤8	0.08-0.12	≤8	0.10-0.20	
			● ● ✖	≤8	0.06-0.10	≤8	0.08-0.15	
		DC(Slot)	● ● ✖	≤5	0.06-0.10	≤5	0.08-0.15	
			● ● ✖	≤5	0.06-0.08	≤5	0.08-0.12	
Ductile Cast Iron	Tensile Strength ≤800MPa	≤0.25DC	● ● ✖	≤11	0.10-0.20	≤11	0.10-0.25	
			● ● ✖	≤11	0.10-0.15	≤11	0.10-0.20	
		0.25-0.5DC	● ● ✖	≤11	0.10-0.15	≤11	0.10-0.20	
			● ● ✖	≤11	0.08-0.12	≤11	0.10-0.15	
		0.5-0.75DC	● ● ✖	≤8	0.08-0.12	≤8	0.10-0.15	
			● ● ✖	≤8	0.06-0.10	≤8	0.08-0.12	
		DC(Slot)	● ● ✖	≤5	0.06-0.10	≤5	0.08-0.12	
			● ● ✖	≤5	0.06-0.08	≤5	0.06-0.10	
N Aluminium Alloy	Content Si <5%	≤0.25DC	● ● ✖	≤11	0.10-0.25	≤11	0.10-0.25	
			● ● ✖	≤11	0.10-0.20	≤11	0.10-0.20	
		0.25-0.5DC	● ● ✖	≤11	0.10-0.20	≤11	0.10-0.20	
			● ● ✖	≤11	0.10-0.15	≤11	0.10-0.15	
		0.5-0.75DC	● ● ✖	≤8	0.06-0.15	≤8	0.08-0.15	
			● ● ✖	≤8	0.06-0.15	≤8	0.08-0.15	
		DC(Slot)	● ● ✖	≤5	0.06-0.15	≤5	0.08-0.15	
			● ● ✖	≤5	0.06-0.15	≤5	0.08-0.12	
S Titanium Alloy (Ti-6Al-4V, etc.)	-	≤0.25DC	● ● ✖	≤11	0.08-0.15	≤11	0.08-0.15	
		0.25-0.5DC	● ● ✖	≤11	0.08-0.12	≤11	0.08-0.12	
		0.5-0.75DC	● ● ✖	≤8	0.06-0.10	≤8	0.06-0.10	
		DC(Slot)	● ● ✖	≤5	0.06-0.10	≤5	0.06-0.10	
	Titanium Alloy (Ti-5Al-5V-5Mo-3Cr, etc.)	-	≤0.25DC	● ● ✖	≤11	0.08-0.12	≤11	0.08-0.12
			0.25-0.5DC	● ● ✖	≤11	0.08-0.12	≤11	0.08-0.12
			0.5-0.75DC	● ● ✖	≤8	0.06-0.10	≤8	0.06-0.10
			DC(Slot)	● ● ✖	≤5	0.06-0.10	≤5	0.06-0.10
	Heat Resistant Alloy	-	≤0.25DC	● ● ✖	≤11	0.08-0.12	≤11	0.08-0.12
			0.25-0.5DC	● ● ✖	≤11	0.08-0.12	≤11	0.08-0.12
			0.5-0.75DC	● ● ✖	≤8	0.06-0.10	≤8	0.06-0.10
			DC(Slot)	● ● ✖	≤5	0.06-0.10	≤5	0.06-0.10
H Hardened Steel	Hardness 40-55HRC	≤0.25DC	● ● ✖	≤5	0.08-0.15	≤5	0.08-0.15	
			● ● ✖	≤5	0.08-0.12	≤5	0.08-0.12	
		0.25-0.5DC	● ● ✖	≤4	0.08-0.12	≤4	0.08-0.12	
			● ● ✖	≤4	0.06-0.10	≤4	0.06-0.10	
		0.5-0.75DC	● ● ✖	≤3	0.06-0.10	≤3	0.06-0.10	
			● ● ✖	≤3	0.06-0.10	≤3	0.06-0.08	
		DC(Slot)	● ● ✖	≤2	0.06-0.10	≤2	0.06-0.10	
			● ● ✖	≤2	0.06-0.10	≤2	0.06-0.08	

Note 1) These cutting conditions should be referenced for standard shank types (last letter in designation is S) and arbor shank types. If there is chatter, insert chipping, etc. during machining, alter conditions accordingly.

Note 2) Chattering and vibrations are more likely under the following circumstances. Use a cut and feed per tooth that are at minimum recommended conditions or below.

- When tool overhang is long (using a long shank, screw-in type, etc.)
- Rigidity of machine, work material or attachment of work material is low
- At a corner radius during pocket milling

Note 3) A type with fewer teeth is recommended when the depth of cut in the radial direction (ae) is 0.5 DC or more.

Note 4) Wet cutting is recommended, when focusing on the surface finish. (Service life is shorter than for dry cutting.)

Note 5) When using higher than recommended cutting conditions, or for long periods of time, the clamp screw may become fatigued and break during machining. Please change out the clamp screw periodically.

■ Ramping / Helical Cutting

● Ramping

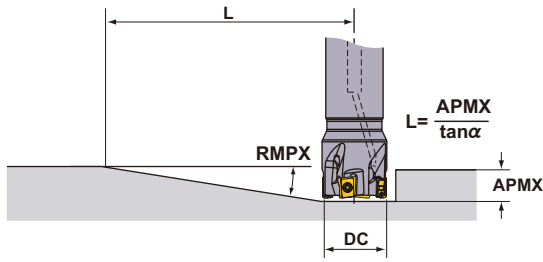

● Helical Cutting

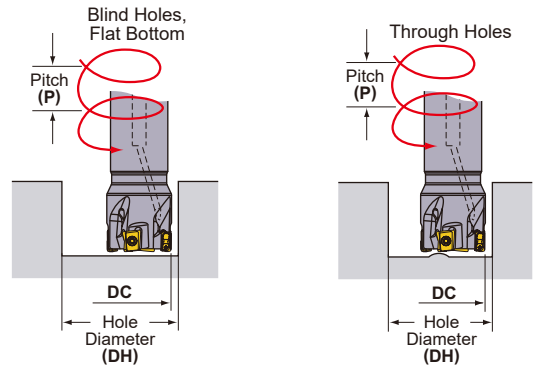

Refer to the table below for cutting conditions. For feed per tooth and cutting speed, follow the cutting conditions for slot milling.

DC (mm)	RE (mm)	Ramping		Helical Cutting (Blind Hole, Flat Bottom)				Helical Cutting (Through Hole)	
		RMPX	L (mm) *	DH max. (mm)	P max. (mm)	DH min. (mm)	P max. (mm)	DH min. (mm)	P max. (mm)
25	0.2	2.13°	296	49.0	2.8	42.7	2.1	36.9	1.4
	0.4	2.13°	296	48.6	2.8	42.7	2.1	36.9	1.4
	0.8	2.13°	296	47.8	2.7	42.7	2.1	36.9	1.4
	1.0	2.13°	296	47.4	2.6	42.7	2.1	36.9	1.4
	1.2	2.13°	296	47.0	2.6	42.7	2.1	36.9	1.4
	1.6	2.13°	296	46.2	2.5	42.7	2.1	36.9	1.4
	2.0	2.13°	296	45.4	2.4	42.7	2.1	36.9	1.4
	2.4	2.13°	296	44.6	2.3	42.7	2.1	36.9	1.4
	3.0	2.13°	296	43.4	2.2	42.7	2.1	36.9	1.4
3.2	2.13°	296	43.0	2.1	42.7	2.1	36.9	1.4	
28	0.2	1.77°	356	55.0	2.6	48.7	2.0	42.7	1.4
	0.4	1.77°	356	54.6	2.6	48.7	2.0	42.7	1.4
	0.8	1.77°	356	53.8	2.5	48.7	2.0	42.7	1.4
	1.0	1.77°	356	53.4	2.5	48.7	2.0	42.7	1.4
	1.2	1.77°	356	53.0	2.4	48.7	2.0	42.7	1.4
	1.6	1.77°	356	52.2	2.4	48.7	2.0	42.7	1.4
	2.0	1.77°	356	51.4	2.3	48.7	2.0	42.7	1.4
	2.4	1.77°	356	50.6	2.2	48.7	2.0	42.7	1.4
	3.0	1.77°	356	49.4	2.1	48.7	2.0	42.7	1.4
3.2	1.77°	356	49.0	2.0	48.7	2.0	42.7	1.4	
30	0.2	1.61°	392	59.0	2.6	52.7	2.0	46.6	1.5
	0.4	1.61°	392	58.6	2.5	52.7	2.0	46.6	1.5
	0.8	1.61°	392	57.8	2.5	52.7	2.0	46.6	1.5
	1.0	1.61°	392	57.4	2.4	52.7	2.0	46.6	1.5
	1.2	1.61°	392	57.0	2.4	52.7	2.0	46.6	1.5
	1.6	1.61°	392	56.2	2.3	52.7	2.0	46.6	1.5
	2.0	1.61°	392	55.4	2.2	52.7	2.0	46.6	1.5
	2.4	1.61°	392	54.6	2.2	52.7	2.0	46.6	1.5
	3.0	1.61°	392	53.4	2.1	52.7	2.0	46.6	1.5
3.2	1.61°	392	53.0	2.0	52.7	2.0	46.6	1.5	
32	0.2	1.47°	429	63.0	2.5	56.7	2.0	50.6	1.5
	0.4	1.47°	429	62.6	2.5	56.7	2.0	50.6	1.5
	0.8	1.47°	429	61.8	2.4	56.7	2.0	50.6	1.5
	1.0	1.47°	429	61.4	2.4	56.7	2.0	50.6	1.5
	1.2	1.47°	429	61.0	2.3	56.7	2.0	50.6	1.5
	1.6	1.47°	429	60.2	2.3	56.7	2.0	50.6	1.5
	2.0	1.47°	429	59.4	2.2	56.7	2.0	50.6	1.5
	2.4	1.47°	429	58.6	2.1	56.7	2.0	50.6	1.5
	3.0	1.47°	429	57.4	2.1	56.7	2.0	50.6	1.5
3.2	1.47°	429	57.0	2.0	56.7	2.0	50.6	1.5	
35	0.2	1.28°	493	69.0	2.4	62.8	1.9	56.6	1.5
	0.4	1.28°	493	68.6	2.4	62.8	1.9	56.6	1.5
	0.8	1.28°	493	67.8	2.3	62.8	1.9	56.6	1.5
	1.0	1.28°	493	67.4	2.3	62.8	1.9	56.6	1.5
	1.2	1.28°	493	67.0	2.2	62.8	1.9	56.6	1.5
	1.6	1.28°	493	66.2	2.2	62.8	1.9	56.6	1.5
	2.0	1.28°	493	65.4	2.1	62.8	1.9	56.6	1.5
	2.4	1.28°	493	64.6	2.1	62.8	1.9	56.6	1.5
	3.0	1.28°	493	63.4	2.0	62.8	1.9	56.6	1.5
3.2	1.28°	493	63.0	2.0	62.8	1.9	56.6	1.5	

Note 1) When machining a highly ductile work material with the ramping angles in the table above, chips may be elongated.

* Shows the distance until a maximum depth of cut of 11 mm is achieved at the maximum ramping angle $L (= 11/\tan \alpha)$.

■ Ramping / Helical Cutting

● Ramping

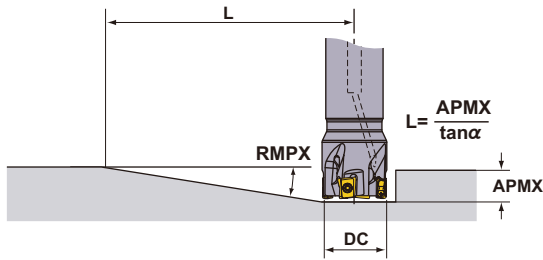

● Helical Cutting

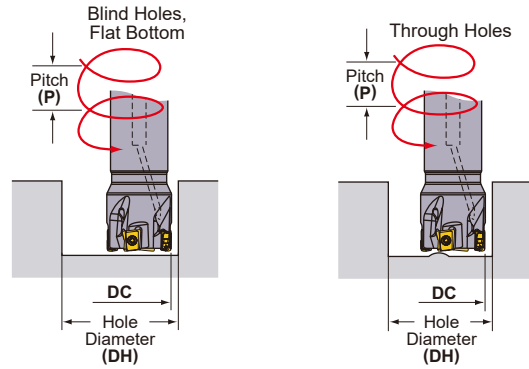

Refer to the table below for cutting conditions. For feed per tooth and cutting speed, follow the cutting conditions for slot milling.

DC (mm)	RE (mm)	Ramping		Helical Cutting (Blind Hole, Flat Bottom)				Helical Cutting (Through Hole)	
		RMPX	L (mm) *	DH max. (mm)	P max. (mm)	DH min. (mm)	P max. (mm)	DH min. (mm)	P max. (mm)
40	0.2	1.06°	595	78.8	2.3	72.7	1.9	66.5	1.5
	0.4	1.06°	595	78.4	2.2	72.7	1.9	66.5	1.5
	0.8	1.06°	595	77.6	2.2	72.7	1.9	66.5	1.5
	1.0	1.06°	595	77.2	2.2	72.7	1.9	66.5	1.5
	1.2	1.06°	595	76.8	2.1	72.7	1.9	66.5	1.5
	1.6	1.06°	595	76.0	2.1	72.7	1.9	66.5	1.5
	2.0	1.06°	595	75.2	2.0	72.7	1.9	66.5	1.5
	2.4	1.06°	595	74.4	2.0	72.7	1.9	66.5	1.5
	3.0	1.06°	595	73.2	1.9	72.7	1.9	66.5	1.5
3.2	1.06°	595	72.8	1.9	72.7	1.9	66.5	1.5	
50	0.2	0.79°	798	98.8	2.1	92.7	1.8	86.5	1.6
	0.4	0.79°	798	98.4	2.1	92.7	1.8	86.5	1.6
	0.8	0.79°	798	97.6	2.1	92.7	1.8	86.5	1.6
	1.0	0.79°	798	97.2	2.0	92.7	1.8	86.5	1.6
	1.2	0.79°	798	96.8	2.0	92.7	1.8	86.5	1.6
	1.6	0.79°	798	96.0	2.0	92.7	1.8	86.5	1.6
	2.0	0.79°	798	95.2	2.0	92.7	1.8	86.5	1.6
	2.4	0.79°	798	94.4	1.9	92.7	1.8	86.5	1.6
	3.0	0.79°	798	93.2	1.9	92.7	1.8	86.5	1.6
3.2	0.79°	798	92.8	1.9	92.7	1.8	86.5	1.6	
63	0.2	0.6°	1051	124.8	2.0	118.7	1.8	112.5	1.6
	0.4	0.6°	1051	124.4	2.0	118.7	1.8	112.5	1.6
	0.8	0.6°	1051	123.6	2.0	118.7	1.8	112.5	1.6
	1.0	0.6°	1051	123.2	2.0	118.7	1.8	112.5	1.6
	1.2	0.6°	1051	122.8	2.0	118.7	1.8	112.5	1.6
	1.6	0.6°	1051	122.0	1.9	118.7	1.8	112.5	1.6
	2.0	0.6°	1051	121.2	1.9	118.7	1.8	112.5	1.6
	2.4	0.6°	1051	120.4	1.9	118.7	1.8	112.5	1.6
	3.0	0.6°	1051	119.2	1.9	118.7	1.8	112.5	1.6
3.2	0.6°	1051	118.8	1.8	118.7	1.8	112.5	1.6	
80	0.2	0.45°	1401	158.8	1.9	152.6	1.8	146.5	1.6
	0.4	0.45°	1401	158.4	1.9	152.7	1.8	146.5	1.6
	0.8	0.45°	1401	157.6	1.9	152.7	1.8	146.5	1.6
	1.0	0.45°	1401	157.2	1.9	152.7	1.8	146.5	1.6
	1.2	0.45°	1401	156.8	1.9	152.7	1.8	146.5	1.6
	1.6	0.45°	1401	156.0	1.9	152.7	1.8	146.5	1.6
	2.0	0.45°	1401	155.2	1.9	152.7	1.8	146.5	1.6
	2.4	0.45°	1401	154.4	1.8	152.7	1.8	146.5	1.6
	3.0	0.45°	1401	153.2	1.8	152.7	1.8	146.5	1.6
3.2	0.45°	1401	152.8	1.8	152.7	1.8	146.5	1.6	

Note 1) When machining a highly ductile work material with the ramping angles in the table above, chips may be elongated.

* Shows the distance until a maximum depth of cut of 11 mm is achieved at the maximum ramping angle $L (= 11/\tan \alpha)$.

■ For Plunging and Drilling

See the tables to the right for cutting conditions. Follow the cutting conditions for slot milling regarding feed per tooth and cutting speed.

● Plunging

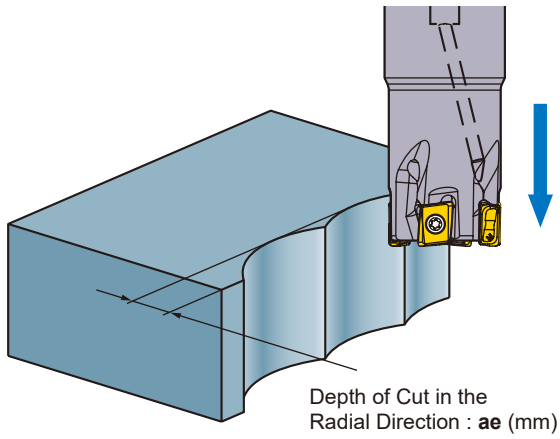

DC (mm)	ae max. (mm)
25	6.5
28	6.6
30	6.6
32	6.6
35	6.7
40	6.7
50	6.7
63	6.7
80	6.7

Note 1) No step feed necessary.

● Drilling

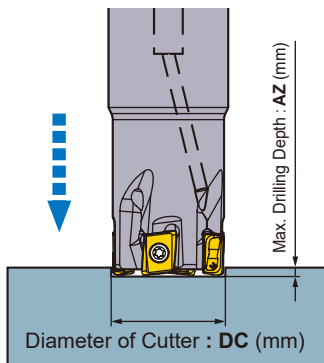

DC (mm)	AZ max. (mm)
25	0.55
28	0.55
30	0.55
32	0.55
35	0.55
40	0.55
50	0.55
63	0.55
80	0.55

Note 1) Exercise due caution as chips scatter easily.

Note 2) Use compressed air to eliminate chips (or coolant for when machining aluminium alloy).

ROTATING TOOLS

DEEP SHOULDER MILLING



VPX200

NEW

LONG CUTTING EDGE

P

M

K

N

S

H

K

ROTATING TOOLS



Fig.1

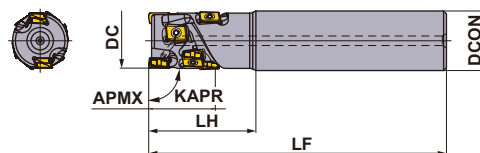
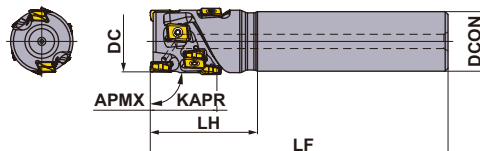

Fig.2



Right hand tool holder only.

■ CYLINDRICAL SHANK

With Coolant Hole

DC (mm)	Order Number	Stock R	Number of Flutes	Total	Dimensions (mm)			APMX (mm)	RMPX	WT ^{*2} (kg)	Fig.	Insert Type ^{*1}
					DCON	LF	LH					
20	VPX200R202SA20S01404	●	2	4	20	100	30	14	1.35°	0.21	1	LOGU09
22	VPX200R222SA20S01404	●	2	4	20	115	30	14	1.16°	0.26	2	LOGU09
25	VPX200R252SA25S02106	●	2	6	25	115	35	21	0.97°	0.39	1	LOGU09
25	VPX200R252SA25S02808	●	2	8	25	125	45	28	0.97°	0.41	1	LOGU09
28	VPX200R282SA25S02106	★	2	6	25	115	35	21	0.84°	0.40	2	LOGU09
28	VPX200R282SA25S02808	★	2	8	25	125	45	28	0.84°	0.43	2	LOGU09
32	VPX200R322SA32S02808	★	2	8	32	125	45	28	0.71°	0.68	1	LOGU09
32	VPX200R323SA32S02812	●	3	12	32	125	45	28	0.71°	0.67	1	LOGU09
32	VPX200R322SA32S03510	★	2	10	32	130	50	35	0.71°	0.70	1	LOGU09
32	VPX200R323SA32S03515	●	3	15	32	130	50	35	0.71°	0.68	1	LOGU09
35	VPX200R352SA32S02808	★	2	8	32	125	45	28	0.63°	0.72	2	LOGU09
35	VPX200R353SA32S02812	★	3	12	32	125	45	28	0.63°	0.71	2	LOGU09
35	VPX200R352SA32S03510	★	2	10	32	130	50	35	0.63°	0.74	2	LOGU09
35	VPX200R353SA32S03515	★	3	15	32	130	50	35	0.63°	0.73	2	LOGU09
40	VPX200R403SA32S03515	★	3	15	32	130	50	35	0.54°	0.81	2	LOGU09
40	VPX200R404SA32S03520	●	4	20	32	130	50	35	0.54°	0.80	2	LOGU09
40	VPX200R403SA32S04218	★	3	18	32	140	60	42	0.54°	0.88	2	LOGU09
40	VPX200R404SA32S04224	★	4	24	32	140	60	42	0.54°	0.86	2	LOGU09

*1 Corner radius RE 0.8mm is recommended for the peripheral cutting edges except the bottom cutting edge (end cutting).

Insert RE 0.2mm and 0.4 mm can also be used for the peripheral cutting edges.

*2 WT : Tool Weight

SPARE PARTS

DC (mm)	Tool Holder Type	*		
		Clamp Screw	Wrench	Anti-seize Lubricant
20	VPX200R20	TPS27F1	TIP07F	MK1KS
22	VPX200R22	TPS27F2	TIP07F	MK1KS
25	VPX200R25	TPS27F2	TIP07F	MK1KS
28	VPX200R28	TPS27F2	TIP07F	MK1KS
32	VPX200R32	TPS27F2	TIP07F	MK1KS
35	VPX200R35	TPS27F2	TIP07F	MK1KS
40	VPX200R40	TPS27F2	TIP07F	MK1KS

* Clamp Torque (N · m) : TPS27F1 = 1.0, TPS27F2 = 1.0

● : Inventory maintained. ★ : Inventory maintained in Japan.



Fig.1

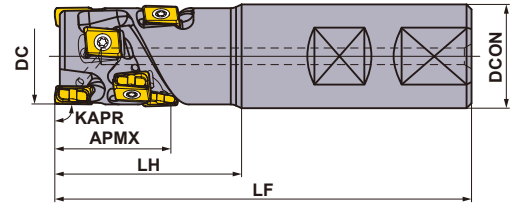

Right hand tool holder only.

WELDON SHANK TYPE

With Coolant Hole



DC (mm)	Order Number	Stock R	Number of Flutes	Total	Dimensions (mm)			APMX (mm)	RMPX	WT ^{*2} (kg)	Fig.	Insert Type ^{*1}
					DCON	LF	LH					
20	VPX200R202WA20S01404	●	2	4	20	80	30	14	1.35°	0.16	1	LOGU09
25	VPX200R252WA25S02106	●	2	6	25	91	35	21	0.97°	0.29	1	LOGU09
25	VPX200R252WA25S02808	●	2	8	25	101	45	28	0.97°	0.32	1	LOGU09
32	VPX200R322WA32S02808	●	2	8	32	105	45	28	0.71°	0.55	1	LOGU09
32	VPX200R323WA32S02812	●	3	12	32	105	45	28	0.71°	0.54	1	LOGU09
32	VPX200R322WA32S03510	●	2	10	32	110	50	35	0.71°	0.57	1	LOGU09
32	VPX200R323WA32S03515	●	3	15	32	110	50	35	0.71°	0.55	1	LOGU09

*1 Corner radius RE 0.8mm is recommended for the peripheral cutting edges except the bottom cutting edge (end cutting).

Insert RE 0.2mm and 0.4 mm can also be used for the peripheral cutting edges.

*2 WT : Tool Weight

SPARE PARTS

DC (mm)	Tool Holder Type	*		
				
		Clamp Screw	Wrench	Anti-seize Lubricant
20	VPX200R20	TPS27F1	TIP07F	MK1KS
25	VPX200R25	TPS27F2	TIP07F	MK1KS
32	VPX200R32	TPS27F2	TIP07F	MK1KS

* Clamp Torque (N · m) : TPS27F1 = 1.0, TPS27F2 = 1.0

ROTATING TOOLS

K

ROTATING TOOLS



Fig.1

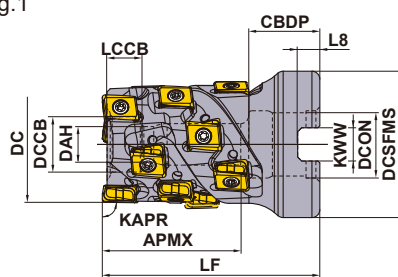
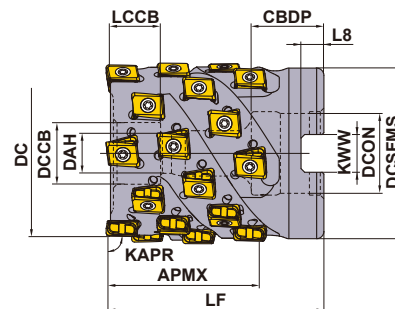

Fig.2



Right hand tool holder only.

■ SHELL TYPE

KAPR: 90°
GAMP: -6° GAMF: -25°
With Coolant Hole

DC (mm)	APMX	Set Bolt	Geometry
φ32	35	HSC08045	
φ40	42	HSC08050	
φ50	42	HSC10045	

DC (mm)	Order Number	Stock R	Number of Flutes	Total	Dimensions (mm)		WT *2 (kg)	APMX (mm)	RMPX	Fig.	Insert Type *1
					LF	DCON					
32	VPX200-032A02A035R10	★	2	10	55	16	0.22	35	0.71°	1	LOGU09
32	VPX200-032A03A035R15	●	3	15	55	16	0.20	35	0.71°	1	LOGU09
40	VPX200-040A03A042R18	★	3	18	60	16	0.34	42	0.54°	2	LOGU09
40	VPX200-040A04A042R24	●	4	24	60	16	0.33	42	0.54°	2	LOGU09
50	VPX200-050A04A042R24	★	4	24	60	22	0.55	42	0.42°	2	LOGU09
50	VPX200-050A05A042R30	★	5	30	60	22	0.54	42	0.42°	2	LOGU09

*1 Corner radius RE 0.8mm is recommended for the peripheral cutting edges except the bottom cutting edge (end cutting).

Insert RE 0.2mm and 0.4 mm can also be used for the peripheral cutting edges.

*2 WT : Tool Weight

MOUNTING DIMENSIONS

DC (mm)	Order Number	Dimensions (mm)							
		DCON	CBDP	DAH	DCCB	LCCB	DCSFMS	KWW	L8
32	VPX200-032A02A035R10	16	18	9	14	8	37	8.4	5.6
32	VPX200-032A03A035R15	16	18	9	14	8	37	8.4	5.6
40	VPX200-040A03A042R18	16	18	9	14	8	37	8.4	5.6
40	VPX200-040A04A042R24	16	18	9	14	8	37	8.4	5.6
50	VPX200-050A04A042R24	22	20	11	17	13	47	10.4	6.3
50	VPX200-050A05A042R30	22	20	11	17	13	47	10.4	6.3





SPARE PARTS

Tool Holder Type	*				
	Clamp Screw			Wrench	Anti-seize Lubricant
VPX200	TPS27F2			TIP07F	MK1KS

* Clamp Torque (N · m) : TPS27F2 = 1.0

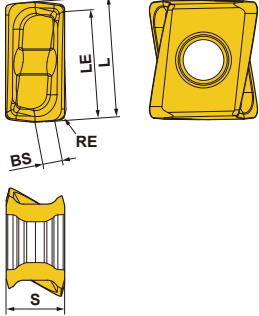
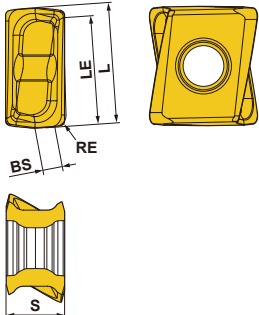
● : Inventory maintained. ★ : Inventory maintained in Japan.
(10 inserts in one case)

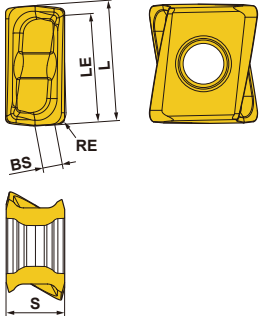
INSERTS

Work Material	P	Steels	●	●	●	●	●	●	●	●	●	●	Cutting Conditions (Guide) : ● : Stable Cutting ● : General Cutting ✦ : Unstable Cutting	Honing : E : Round F : Sharp						
	M	Stainless Steels	●	●	●	●	●	●	●	●	●	●								
Shape	K	Cast Irons	●	●	●	●	●	●	●	●	●	●	Coated	Carbide	Dimensions (mm)					Geometry
	N	Non-ferrous Metals	●	●	●	●	●	●	●	●	●	●			L	RE	LE	S	BS	
	S	Heat Resistant Alloys, Titanium Alloys	●	●	●	●	●	●	●	●	●	●	●	●	●	●	●	●		
	H	Hardened Steels	●	●	●	●	●	●	●	●	●	●	●	●	●	●	●	●		
Order Number	Class	Honing	MC5020	MP6120	MP6130	MP7130	MP9120	MP9130	VP15TF	TF15	L	RE	LE	S	BS	Geometry				
Low Cutting Resistance L Breaker NEW 	LOGU0904020PNER-L	G E	★	★	★	★	★	★	★	★	8.7	0.2	7.6	4.3	1.7	 Right hand insert only.				
	LOGU0904040PNER-L	G E	●	●	●	●	●	●	★		8.7	0.4	7.6	4.3	1.5					
	LOGU0904080PNER-L	G E	●	●	●	●	●	●	★		8.7	0.8	7.6	4.3	1.2					
	LOGU0904100PNER-L	G E	★	★	★	★	★	★	★		8.7	1.0	7.6	4.3	1.0					
	LOGU0904120PNER-L	G E	★	★	★	★	★	★	★		8.7	1.2	7.6	4.3	0.8					
	LOGU0904160PNER-L	G E	●	●	●	●	●	●	★		8.7	1.6	7.6	4.3	0.5					
	LOGU0904020PNFR-L	G F								●	8.7	0.2	7.6	4.3	1.7	 Right hand insert only.				
	LOGU0904040PNFR-L	G F								●	8.7	0.4	7.6	4.3	1.5					
	LOGU0904080PNFR-L	G F								●	8.7	0.8	7.6	4.3	1.2					
	LOGU0904100PNFR-L	G F								★	8.7	1.0	7.6	4.3	1.0					
	LOGU0904120PNFR-L	G F								★	8.7	1.2	7.6	4.3	0.8					
	LOGU0904160PNFR-L	G F								★	8.7	1.6	7.6	4.3	0.5					
	General Use M Breaker 	LOGU0904020PNER-M	G E	★	★	★	★	★	★	★		8.7	0.2	7.6	4.3	1.7	 Right hand insert only.			
		LOGU0904040PNER-M	G E	●	●	●	●	●	●	★		8.7	0.4	7.6	4.3	1.6				
LOGU0904080PNER-M		G E	●	●	●	●	●	●	★		8.7	0.8	7.6	4.3	1.2					
LOGU0904100PNER-M		G E	★	★	★	★	★	★	★		8.7	1.0	7.6	4.3	1.0					
LOGU0904120PNER-M		G E	★	★	★	★	★	★	★		8.7	1.2	7.6	4.3	0.9					
LOGU0904160PNER-M		G E	●	●	●	●	●	●	★		8.7	1.6	7.6	4.3	0.5					
LOGU0904020PNFR-M		G F								●	8.7	0.2	7.6	4.3	1.7	 Right hand insert only.				
LOGU0904040PNFR-M		G F								●	8.7	0.4	7.6	4.3	1.6					
LOGU0904080PNFR-M		G F								●	8.7	0.8	7.6	4.3	1.2					
LOGU0904100PNFR-M		G F								★	8.7	1.0	7.6	4.3	1.0					
LOGU0904120PNFR-M		G F								★	8.7	1.2	7.6	4.3	0.9					
LOGU0904160PNFR-M		G F								★	8.7	1.6	7.6	4.3	0.5					

● ★ = NEW

K

ROTATING TOOLS

CHIPBREAKER RECOMMENDATION

■ Chipbreaker Selection Table

Work Material	Properties	Cutting Conditions	Chipbreaker		Grade		
			1st Recommendation	2nd Recommendation	1st Recommendation	2nd Recommendation	
P Mild Steel	Hardness ≤180HB	● ●	L	M	MP6120	VP15TF	
		● ✖	M	L	MP6130	—	
	Hardness 180-350HB ≤350HB (Annealing)	● ●	L	M	MP6120	VP15TF	
		● ● ✖	M	L	MP6130	—	
Pre-hardened Steel	Hardness 35—45HRC	● ●	M	L	MP6120	VP15TF	
		● ● ✖	M	L	MP6130	—	
M Austenitic Stainless Steel	Hardness ≤280HB	● ●	L	M	MP7130	VP15TF	
		● ● ✖	M	L	MP7130	—	
	Hardness >200HB	● ●	L	M	MP7130	VP15TF	
		● ● ✖	M	L	MP7130	—	
	Duplex Stainless Steel	Hardness ≤280HB	● ●	L	M	MP7130	VP15TF
			● ● ✖	M	L	MP7130	—
Ferritic and Martensitic Stainless Steel	—	● ●	L	M	MP7130	VP15TF	
		● ● ✖	M	L	MP7130	—	
Precipitation Hardening Stainless Steel	Hardness <450HB	● ●	L	M	MP7130	VP15TF	
		● ● ✖	M	L	MP7130	—	
K Gray Cast Iron	Tensile Strength ≤350MPa	● ●	M	L	MC5020	VP15TF	
		● ● ✖	M	L	VP15TF	—	
Ductile Cast Iron	Tensile Strength ≤800MPa	● ●	M	L	MC5020	VP15TF	
		● ● ✖	M	L	VP15TF	—	
N Aluminium Alloy	Content Si <5%	● ●	L	M	TF15	—	
		● ● ✖	M	L	TF15	—	
S Titanium Alloy (Ti-6Al-4V, etc.)	—	● ●	L	M	MP9120	VP15TF	
		● ● ✖	M	L	MP9130	—	
	Titanium Alloy (Ti-5Al-5V-5Mo-3Cr, etc.)	—	● ●	L	M	MP9120	VP15TF
			● ● ✖	M	L	MP9130	—
Heat Resistant Alloy	—	● ●	M	L	MP9120	VP15TF	
		● ● ✖	M	L	MP9130	—	
H Hardened Steel	Hardness 40—55HRC	● ● ✖	M	—	VP15TF	—	

K

ROTATING TOOLS

Cutting Conditions (Guide) :

● : Stable Cutting ● : General Cutting ✖ : Unstable Cutting

RECOMMENDED CUTTING CONDITIONS

Cutting Speed

(mm)

Work Material	Properties	Cutting Conditions	Grade	ae				Cutting Mode		
				≤0.25DC	0.25—0.5DC	0.5—0.75DC	DC(Slot)			
				Vc (m/min)						
P	Mild Steel	Hardness ≤180HB	● ●	MP6120,VP15TF	140(100—190)	130(90—180)	100(70—120)	100(70—120)	Dry, Wet	
			● ✖	MP6130	140(100—190)	130(90—180)	100(70—120)	100(70—120)	Dry, Wet	
	Carbon Steel Alloy Steel	Hardness 180—350HB	● ●	MP6120,VP15TF	120(90—140)	110(80—130)	100(70—120)	100(70—120)	Dry, Wet	
			● ✖	MP6130	120(90—140)	110(80—130)	100(70—120)	100(70—120)	Dry, Wet	
	Pre-hardened Steel	Hardness 180—350HB	● ●	MP6120,VP15TF	100(80—120)	90(70—110)	80(60—100)	80(60—100)	Dry, Wet	
			● ✖	MP6130	100(80—120)	90(70—110)	80(60—100)	80(60—100)	Dry, Wet	
M	Austenitic Stainless Steel	Hardness ≤200HB	● ●	MP7130,VP15TF	120(100—150)	110(90—140)	90(70—120)	90(70—120)	Dry, Wet	
			● ✖	MP7130	120(100—150)	110(90—140)	90(70—120)	90(70—120)	Dry, Wet	
		Hardness >200HB	● ●	MP7130,VP15TF	100(80—130)	90(70—120)	70(50—100)	70(50—100)	Dry, Wet	
			● ✖	MP7130	100(80—130)	90(70—120)	70(50—100)	70(50—100)	Dry, Wet	
	Ferritic and Martensitic Stainless Steel	—	● ●	MP7130,VP15TF	120(100—150)	110(90—140)	90(70—120)	90(70—120)	Dry, Wet	
			● ✖	MP7130	120(100—150)	110(90—140)	90(70—120)	90(70—120)	Dry, Wet	
	Duplex Stainless Steel	Hardness ≤280HB	● ●	MP7130,VP15TF	100(80—130)	90(70—120)	70(50—100)	70(50—100)	Dry, Wet	
			● ✖	MP7130	100(80—130)	90(70—120)	70(50—100)	70(50—100)	Dry, Wet	
	Precipitation Hardening Stainless Steel	Hardness <450HB	● ●	MP7130,VP15TF	90(70—120)	80(60—110)	60(40—90)	60(40—90)	Dry, Wet	
			● ✖	MP7130	90(70—120)	80(60—110)	60(40—90)	60(40—90)	Dry, Wet	
	K	Gray Cast Iron	Tensile Strength ≤350MPa	● ●	MC5020	180(160—220)	170(150—210)	150(130—190)	150(130—190)	Dry, Wet
				● ✖	VP15TF	130(100—150)	120(90—140)	100(80—120)	100(80—120)	Dry, Wet
Ductile Cast Iron		Tensile Strength ≤800MPa	● ●	MC5020	160(140—180)	150(130—170)	130(110—150)	130(110—150)	Dry, Wet	
			● ✖	VP15TF	110(80—140)	100(70—130)	80(60—120)	80(60—120)	Dry, Wet	
N	Aluminium Alloy	Content Si <5%	● ● ✖	TF15	600(400—1000)	600(400—1000)	600(400—1000)	600(400—1000)	Dry, Wet	
S	Titanium Alloy (Ti-6Al-4V etc.)	—	● ●	MP9120	50(40—70)	50(40—70)	50(40—70)	50(40—70)	Wet	
			●	VP15TF	50(40—70)	50(40—70)	50(40—70)	50(40—70)	Wet	
			● ✖	MP9130	50(40—70)	50(40—70)	50(40—70)	50(40—70)	Wet	
	Titanium Alloy (Ti-6Al-5V-5Mo-3Cr etc.)	—	● ●	MP9120	30(20—40)	30(20—40)	30(20—40)	30(20—40)	Wet	
			●	VP15TF	30(20—40)	30(20—40)	30(20—40)	30(20—40)	Wet	
			● ✖	MP9130	30(20—40)	30(20—40)	30(20—40)	30(20—40)	Wet	
	Heat Resistant Alloy	—	● ●	MP9120	40(30—60)	40(30—60)	40(30—60)	40(30—60)	Wet	
			●	VP15TF	40(30—60)	40(30—60)	40(30—60)	40(30—60)	Wet	
			● ✖	MP9130	40(30—60)	40(30—60)	40(30—60)	40(30—60)	Wet	

Note 1) If there is chatter, insert chipping, etc. during machining, alter conditions accordingly.

Note 2) Chattering and vibrations are more likely under the following circumstances. Use a cut and feed per tooth that are at minimum recommended conditions or below.

- When tool overhang is long
- Rigidity of machine, work material or attachment of work material is low
- At a corner radius during pocket milling

Note 3) A type with fewer teeth is recommended when the depth of cut in the radial direction (ae) is 0.5 DC or more.

Note 4) Wet cutting is recommended, when focusing on the surface finish. (Service life is shorter than for dry cutting.)

Note 5) When using higher than recommended cutting conditions, or for long periods of time, the clamp screw may become fatigued and break during machining. Please change out the clamp screw periodically.

K

ROTATING TOOLS

RECOMMENDED CUTTING CONDITIONS

■ Depth of Cut / Feed per Tooth

(mm)

Work Material	Properties	ae	Cutting Conditions	DC				
				ø20-ø28		ø32-ø50		
				ap	fz (mm/t.)	ap	fz (mm/t.)	
P	Mild Steel	≤0.25DC	● ● ✱	≤14	0.13(0.10-0.15)	≤APMX	0.15(0.10-0.20)	
		0.25-0.5DC	● ● ✱	≤8	0.10(0.08-0.12)	≤28	0.13(0.10-0.15)	
		0.5-0.75DC	● ● ✱	≤6	0.10(0.08-0.12)	≤14	0.10(0.08-0.12)	
		DC(Slot)	● ● ✱	≤4	0.08(0.06-0.10)	≤4	0.08(0.06-0.10)	
	Carbon Steel Alloy Steel	Hardness 180-280HB	≤0.25DC	● ● ✱	≤14	0.13(0.10-0.15)	≤APMX	0.15(0.10-0.20)
		0.25-0.5DC	● ● ✱	≤8	0.10(0.08-0.12)	≤28	0.13(0.10-0.15)	
		0.5-0.75DC	● ● ✱	≤6	0.10(0.08-0.12)	≤14	0.10(0.08-0.12)	
		DC(Slot)	● ● ✱	≤4	0.08(0.06-0.10)	≤4	0.08(0.06-0.10)	
	Carbon Steel Alloy Steel	Hardness 280-350HB	≤0.25DC	● ● ✱	≤14	0.13(0.10-0.15)	≤APMX	0.13(0.10-0.15)
		0.25-0.5DC	● ● ✱	≤8	0.10(0.08-0.12)	≤28	0.10(0.08-0.12)	
		0.5-0.75DC	● ● ✱	≤6	0.10(0.08-0.12)	≤14	0.08(0.06-0.10)	
		DC(Slot)	● ● ✱	≤4	0.08(0.06-0.10)	≤4	0.08(0.06-0.10)	
	Pre-hardened Steel	Hardness 35-45HRC	≤0.25DC	● ● ✱	≤14	0.13(0.10-0.15)	≤APMX	0.13(0.10-0.15)
		0.25-0.5DC	● ● ✱	≤8	0.10(0.08-0.12)	≤28	0.10(0.08-0.12)	
		0.5-0.75DC	● ● ✱	≤6	0.10(0.08-0.12)	≤14	0.08(0.06-0.10)	
		DC(Slot)	● ● ✱	≤4	0.08(0.06-0.10)	≤4	0.08(0.06-0.10)	
M	Austenitic Stainless Steel	≤0.25DC	● ● ✱	≤14	0.13(0.10-0.15)	≤APMX	0.15(0.10-0.20)	
			● ● ✱	≤14	0.10(0.08-0.12)	≤APMX	0.12(0.08-0.15)	
		0.25-0.5DC	● ● ✱	≤8	0.10(0.08-0.12)	≤28	0.12(0.08-0.15)	
			● ● ✱	≤8	0.08(0.06-0.10)	≤28	0.10(0.08-0.12)	
		0.5-0.75DC	● ● ✱	≤6	0.08(0.06-0.10)	≤14	0.10(0.08-0.12)	
			● ● ✱	≤6	0.07(0.06-0.08)	≤14	0.08(0.06-0.10)	
		DC(Slot)	● ● ✱	≤4	0.08(0.06-0.10)	≤4	0.08(0.06-0.10)	
			● ● ✱	≤4	0.07(0.06-0.08)	≤4	0.07(0.06-0.08)	
	Ferritic and Martensitic Stainless Steel	≤0.25DC	● ● ✱	≤14	0.13(0.10-0.15)	≤APMX	0.15(0.10-0.20)	
			● ● ✱	≤14	0.10(0.08-0.12)	≤APMX	0.12(0.08-0.15)	
		0.25-0.5DC	● ● ✱	≤8	0.10(0.08-0.12)	≤28	0.12(0.08-0.15)	
			● ● ✱	≤8	0.08(0.06-0.10)	≤28	0.10(0.08-0.12)	
		0.5-0.75DC	● ● ✱	≤6	0.08(0.06-0.10)	≤14	0.10(0.08-0.12)	
			● ● ✱	≤6	0.07(0.06-0.08)	≤14	0.08(0.06-0.10)	
		DC(Slot)	● ● ✱	≤4	0.08(0.06-0.10)	≤4	0.08(0.06-0.10)	
			● ● ✱	≤4	0.07(0.06-0.08)	≤4	0.07(0.06-0.08)	
Duplex Stainless Steel	≤0.25DC	● ● ✱	≤14	0.13(0.10-0.15)	≤APMX	0.15(0.10-0.20)		
		● ● ✱	≤14	0.10(0.08-0.12)	≤APMX	0.12(0.08-0.15)		
	0.25-0.5DC	● ● ✱	≤8	0.10(0.08-0.12)	≤28	0.12(0.08-0.15)		
		● ● ✱	≤8	0.08(0.06-0.10)	≤28	0.10(0.08-0.12)		
	0.5-0.75DC	● ● ✱	≤6	0.08(0.06-0.10)	≤14	0.10(0.08-0.12)		
		● ● ✱	≤6	0.07(0.06-0.08)	≤14	0.08(0.06-0.10)		
	DC(Slot)	● ● ✱	≤4	0.08(0.06-0.10)	≤4	0.08(0.06-0.10)		
		● ● ✱	≤4	0.07(0.06-0.08)	≤4	0.07(0.06-0.08)		
Precipitation Hardening Stainless Steel	≤0.25DC	● ● ✱	≤14	0.13(0.10-0.15)	≤APMX	0.13(0.10-0.15)		
		● ● ✱	≤14	0.10(0.08-0.12)	≤APMX	0.10(0.08-0.12)		
	0.25-0.5DC	● ● ✱	≤8	0.10(0.08-0.12)	≤28	0.10(0.08-0.12)		
		● ● ✱	≤8	0.08(0.06-0.10)	≤28	0.10(0.08-0.12)		
	0.5-0.75DC	● ● ✱	≤6	0.08(0.06-0.10)	≤14	0.08(0.06-0.10)		
		● ● ✱	≤6	0.07(0.06-0.08)	≤14	0.07(0.06-0.08)		
	DC(Slot)	● ● ✱	≤4	0.08(0.06-0.10)	≤4	0.08(0.06-0.10)		
		● ● ✱	≤4	0.07(0.06-0.08)	≤4	0.07(0.06-0.08)		

K

ROTATING TOOLS

Cutting Conditions (Guide) :

● : Stable Cutting ● : General Cutting ✖ : Unstable Cutting

								(mm)		
Work Material	Properties	ae	Cutting Conditions	DC						
				ø20—ø28		ø32—ø50				
				ap	fz (mm/t.)	ap	fz (mm/t.)			
K	Gray Cast Iron	Tensile Strength ≤350MPa	● ●	≤14	0.13(0.10—0.15)	≤APMX	0.15(0.10—0.20)			
				● ● ✖	≤14	0.10(0.08—0.12)	≤APMX	0.12(0.08—0.15)		
			● ●	● ● ✖	≤8	0.10(0.08—0.12)	≤28	0.12(0.08—0.15)		
					● ● ✖	≤8	0.08(0.06—0.10)	≤28	0.10(0.08—0.12)	
			● ●	● ● ✖	≤6	0.10(0.08—0.12)	≤14	0.10(0.08—0.12)		
					● ● ✖	≤6	0.08(0.06—0.10)	≤14	0.08(0.06—0.10)	
			● ●	● ● ✖	DC(Slot)	≤4	0.08(0.06—0.10)	≤4	0.08(0.06—0.10)	
					● ● ✖	≤4	0.07(0.06—0.08)	≤4	0.07(0.06—0.08)	
			Ductile Cast Iron	—	● ●	≤14	0.13(0.10—0.15)	≤APMX	0.15(0.10—0.20)	
						● ● ✖	≤14	0.10(0.08—0.12)	≤APMX	0.13(0.10—0.15)
● ●	● ● ✖	≤8			0.10(0.08—0.12)	≤28	0.13(0.10—0.15)			
		● ● ✖			≤8	0.08(0.06—0.10)	≤28	0.10(0.08—0.12)		
● ●	● ● ✖	≤6			0.10(0.08—0.12)	≤14	0.10(0.08—0.12)			
		● ● ✖			≤6	0.08(0.06—0.10)	≤14	0.08(0.06—0.10)		
● ●	● ● ✖	DC(Slot)			≤4	0.08(0.06—0.10)	≤4	0.08(0.06—0.10)		
		● ● ✖			≤4	0.07(0.06—0.08)	≤4	0.07(0.06—0.08)		
N	Aluminium Alloy	Content Si<5%			● ●	≤14	0.15(0.10—0.20)	≤APMX	0.18(0.10—0.25)	
						● ● ✖	≤14	0.13(0.10—0.15)	≤APMX	0.15(0.10—0.20)
			● ●	● ● ✖	≤8	0.13(0.10—0.15)	≤28	0.15(0.10—0.20)		
					● ● ✖	≤8	0.10(0.08—0.12)	≤28	0.13(0.10—0.15)	
			● ●	● ● ✖	≤6	0.10(0.08—0.12)	≤14	0.11(0.06—0.15)		
					● ● ✖	≤6	0.08(0.06—0.10)	≤14	0.11(0.06—0.15)	
			● ●	● ● ✖	DC(Slot)	≤4	0.08(0.06—0.10)	≤4	0.11(0.06—0.15)	
					● ● ✖	≤4	0.07(0.06—0.08)	≤4	0.09(0.06—0.12)	
			S	Titanium Alloy (Ti-6Al-4V etc.)	—	● ● ✖	≤14	0.12(0.08—0.15)	≤APMX	0.12(0.08—0.15)
							● ● ✖	≤8	0.10(0.08—0.12)	≤28
● ● ✖	≤6	0.08(0.06—0.10)				≤14	0.08(0.06—0.10)			
	● ● ✖	DC(Slot)				≤4	0.08(0.06—0.10)	≤4	0.08(0.06—0.10)	
Titanium Alloy (Ti-5Al-5V-5Mo-3Cr etc.)	—	● ● ✖		≤14	0.10(0.08—0.12)	≤APMX	0.10(0.08—0.12)			
				● ● ✖	≤8	0.10(0.08—0.12)	≤28	0.10(0.08—0.12)		
		● ● ✖		≤6	0.08(0.06—0.10)	≤14	0.08(0.06—0.10)			
				● ● ✖	DC(Slot)	≤4	0.08(0.06—0.10)	≤4	0.08(0.06—0.10)	
Heat Resistant Alloy	—	● ● ✖		≤14	0.10(0.08—0.12)	≤APMX	0.10(0.08—0.12)			
				● ● ✖	≤8	0.10(0.08—0.12)	≤28	0.10(0.08—0.12)		
		● ● ✖		≤6	0.08(0.06—0.10)	≤14	0.08(0.06—0.10)			
				● ● ✖	DC(Slot)	≤4	0.08(0.06—0.10)	≤4	0.08(0.06—0.10)	

Note 1) If there is chatter, insert chipping, etc. during machining, alter conditions accordingly.

Note 2) Chattering and vibrations are more likely under the following circumstances. Use a cut and feed per tooth that are at minimum recommended conditions or below.

- When tool overhang is long
- Rigidity of machine, work material or attachment of work material is low
- At a corner radius during pocket milling

Note 3) A type with fewer teeth is recommended when the depth of cut in the radial direction (ae) is 0.5 DC or more.

Note 4) Wet cutting is recommended, when focusing on the surface finish. (Service life is shorter than for dry cutting.)

Note 5) When using higher than recommended cutting conditions, or for long periods of time, the clamp screw may become fatigued and break during machining. Please change out the clamp screw periodically.

K

ROTATING TOOLS

ROTATING TOOLS

■ Ramping / Helical Cutting

● Ramping

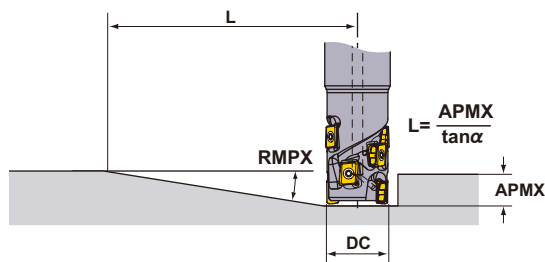

● Helical Cutting

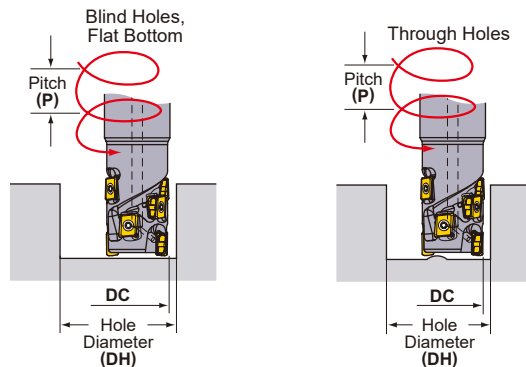

Refer to the table below for cutting conditions. For feed per tooth and cutting speed, follow the cutting conditions for slot milling.

DC (mm)	RE (mm)	Ramping		Helical Cutting (Blind Hole, Flat Bottom)				Helical Cutting (Through Hole)	
		RMPX	L (mm) *	DH max. (mm)	P max. (mm)	DH min. (mm)	P max. (mm)	DH min. (mm)	P max. (mm)
20	0.2	1.35°	340	39.0	1.4	35.5	1.1	32.0	0.9
	0.4	1.35°	340	38.6	1.4	35.5	1.1	32.0	0.9
	0.8	1.35°	340	37.8	1.3	35.5	1.1	32.0	0.9
	1.0	1.35°	340	37.4	1.3	35.5	1.1	32.0	0.9
	1.2	1.35°	340	37.0	1.3	35.5	1.1	32.0	0.9
22	0.2	1.16°	396	43.0	1.3	39.5	1.1	36.0	0.9
	0.4	1.16°	396	42.6	1.3	39.5	1.1	36.0	0.9
	0.8	1.16°	396	41.8	1.3	39.5	1.1	36.0	0.9
	1.0	1.16°	396	41.4	1.2	39.5	1.1	36.0	0.9
	1.2	1.16°	396	41.0	1.2	39.5	1.1	36.0	0.9
25	0.2	0.97°	473	49.0	1.3	45.5	1.1	42.0	0.9
	0.4	0.97°	473	48.6	1.3	45.5	1.1	42.0	0.9
	0.8	0.97°	473	47.8	1.2	45.5	1.1	42.0	0.9
	1.0	0.97°	473	47.4	1.2	45.5	1.1	42.0	0.9
	1.2	0.97°	473	47.0	1.2	45.5	1.1	42.0	0.9
28	0.2	0.84°	546	55.0	1.2	51.5	1.1	48.0	0.9
	0.4	0.84°	546	54.6	1.2	51.5	1.1	48.0	0.9
	0.8	0.84°	546	53.8	1.2	51.5	1.1	48.0	0.9
	1.0	0.84°	546	53.4	1.2	51.5	1.1	48.0	0.9
	1.2	0.84°	546	53.0	1.2	51.5	1.1	48.0	0.9
32	0.2	0.71°	646	62.8	1.2	59.4	1.1	56.0	0.9
	0.4	0.71°	646	62.4	1.2	59.4	1.1	56.0	0.9
	0.8	0.71°	646	61.6	1.2	59.4	1.1	56.0	0.9
	1.0	0.71°	646	61.2	1.1	59.4	1.1	56.0	0.9
	1.2	0.71°	646	60.8	1.1	59.4	1.1	56.0	0.9
35	0.2	0.63°	728	69.0	1.2	65.5	1.1	62.0	0.9
	0.4	0.63°	728	68.6	1.2	65.5	1.1	62.0	0.9
	0.8	0.63°	728	67.8	1.1	65.5	1.1	62.0	0.9
	1.0	0.63°	728	67.4	1.1	65.5	1.1	62.0	0.9
	1.2	0.63°	728	67.0	1.1	65.5	1.1	62.0	0.9
40	0.2	0.54°	849	78.8	1.2	75.4	1.0	72.0	0.9
	0.4	0.54°	849	78.4	1.1	75.4	1.0	72.0	0.9
	0.8	0.54°	849	77.6	1.1	75.4	1.0	72.0	0.9
	1.0	0.54°	849	77.2	1.1	75.4	1.0	72.0	0.9
	1.2	0.54°	849	76.8	1.1	75.4	1.0	72.0	0.9
50	0.2	0.42°	1092	98.8	1.1	95.4	1.0	92.0	1.0
	0.4	0.42°	1092	98.4	1.1	95.4	1.0	92.0	1.0
	0.8	0.42°	1092	97.6	1.1	95.4	1.0	92.0	1.0
	1.0	0.42°	1092	97.2	1.1	95.4	1.0	92.0	1.0
	1.2	0.42°	1092	96.8	1.1	95.4	1.0	92.0	1.0
1.6	0.42°	1092	96.0	1.1	95.4	1.0	92.0	1.0	

Note 1) When machining a highly ductile work material with the ramping angles in the table above, chips may be elongated.
 * Shows the distance until a maximum depth of cut of 8 mm is achieved at the maximum ramping angle $L (= 8/\tan \alpha)$.

K

ROTATING TOOLS

For Plunging and Drilling

See the tables to the right for cutting conditions. Follow the cutting conditions for slot milling regarding feed per tooth and cutting speed.

● Plunging

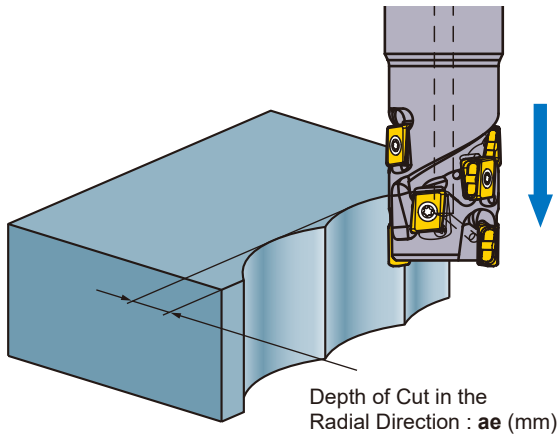

DC (mm)	ae max. (mm)
20	3.9
22	4.0
25	4.0
28	4.0
32	4.0
35	4.0
40	4.0
50	4.0

Note 1) No step feed necessary.

● Drilling

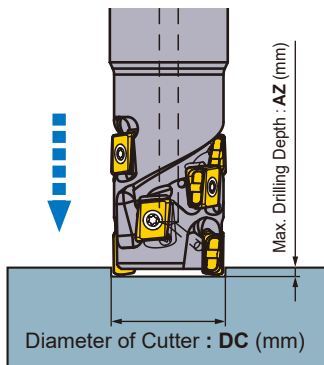

DC (mm)	AZ max. (mm)
20	0.3
22	0.3
25	0.3
28	0.3
32	0.3
35	0.3
40	0.3
50	0.3

Note 1) Exercise due caution as chips scatter easily.

Note 2) Use compressed air to eliminate chips (or coolant for when machining aluminium alloy).

ROTATING TOOLS

DEEP SHOULDER MILLING



VPX300

NEW

LONG CUTTING EDGE

P

M

K

N

S

H

K

ROTATING TOOLS

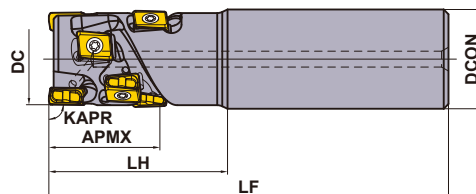

Right hand tool holder only.

■ CYLINDRICAL SHANK

With Coolant Hole

DC (mm)	Order Number	Stock	Number of Flutes	Total	Dimensions (mm)			APMX (mm)	RMPX	WT ^{*2} (kg)	Insert Type ^{*1}
		R			DCON	LF	LH				
40	VPX300R402SA32S02104	●	2	4	32	125	45	21	1.06°	0.78	LOGU12
40	VPX300R402SA32S03106	●	2	6	32	130	50	31	1.06°	0.79	LOGU12
40	VPX300R402SA32S04208	●	2	8	32	140	60	42	1.06°	0.84	LOGU12

*1 Corner radius RE 0.8mm is recommended for the peripheral cutting edges except the bottom cutting edge (end cutting).

Insert RE 0.2mm and 0.4 mm can also be used for the peripheral cutting edges.

*2 WT : Tool Weight

SPARE PARTS

DC (mm)	Tool Holder Type	* (Inventory maintained in Japan)		
		 Clamp Screw	 Wrench	 Anti-seize Lubricant
40	VPX300R40	TPS40F1	TIP15W	MK1KS

* Clamp Torque (N · m) : TPS40F1 = 3.5

● : Inventory maintained. ★ : Inventory maintained in Japan.

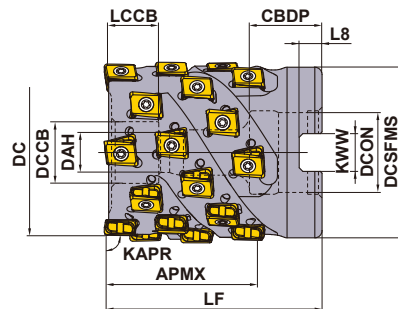

Right hand tool holder only.

Order Number	APMX	Set Bolt	Geometry
VPX300-040A02A031	31	HSC08040	
VPX300-040A02A042	42	HSC08050	
VPX300-050A03A031	31	HSC10040	
VPX300-050A03A042	42	HSC10050	
VPX300-050A03A052	52	HSC10060	
VPX300-063A04A042	42	HSC12050	
VPX300-063A04A052	52	HSC12060	
VPX300-080A05A052	52	HSC12060	
VPX300-080A05A063	63	HSC12070	
VPX300R08005CA052	52	HSC16055	
VPX300R08005CA063	63	HSC16065	

SHELL TYPE

KAPR: 90°
 GAMP: -6° GAMF: -22.5°
 With Coolant Hole
 DCON = mm size

DC (mm)	Order Number	Stock R	Number of Flutes	Total	Dimensions (mm)		WT *2 (kg)	APMX (mm)	RMPX	Insert Type *1
					LF	DCON				
40	VPX300-040A02A031R06	●	2	6	50	16	0.26	31	1.06°	LOGU12
40	VPX300-040A02A042R08	●	2	8	60	16	0.31	42	1.06°	LOGU12
50	VPX300-050A03A031R09	●	3	9	55	22	0.47	31	0.79°	LOGU12
50	VPX300-050A03A042R12	●	3	12	65	22	0.55	42	0.79°	LOGU12
50	VPX300-050A03A052R15	●	3	15	75	22	0.63	52	0.79°	LOGU12
63	VPX300-063A04A042R16	★	4	16	65	27	0.92	42	0.6°	LOGU12
63	VPX300-063A04A052R20	★	4	20	75	27	1.06	52	0.6°	LOGU12
80	VPX300-080A05A052R25	★	5	25	75	27	1.94	52	0.45°	LOGU12
80	VPX300-080A05A063R30	★	5	30	85	27	2.20	63	0.45°	LOGU12

DCON = inch size

DC (mm)	Order Number	Stock R	Number of Flutes	Total	Dimensions (mm)		WT (kg)	APMX (mm)	RMPX	Insert Type
					LF	DCON				
80	VPX300R08005CA05225	★	5	25	75	31.75	1.81	52	0.45°	LOGU12
80	VPX300R08005CA06330	★	5	30	85	31.75	2.06	63	0.45°	LOGU12

*1 Corner radius RE 0.8mm is recommended for the peripheral cutting edges except the bottom cutting edge (end cutting).
 Insert RE 0.2mm and 0.4 mm can also be used for the peripheral cutting edges.

*2 WT : Tool Weight

MOUNTING DIMENSIONS

DC (mm)	Order Number	Dimensions (mm)							
		DCON	CBDP	DAH	DCCB	LCCB	DCSFMS	KWW	L8
40	VPX300-040A02A031R06	16	18	9	14	8.4	37	8.4	5.6
40	VPX300-040A02A042R08	16	18	9	14	8.4	37	8.4	5.6
50	VPX300-050A03A031R09	22	20	11	17	12.4	47	10.4	6.3
50	VPX300-050A03A042R12	22	20	11	17	12.4	47	10.4	6.3
50	VPX300-050A03A052R15	22	20	11	17	12.4	47	10.4	6.3
63	VPX300-063A04A042R16	27	23	13	20	12.4	76	12.4	7.0
63	VPX300-063A04A052R20	27	23	13	20	12.4	76	12.4	7.0
80	VPX300-080A05A052R25	27	23	13	20	12.4	76	12.4	7.0
80	VPX300-080A05A063R30	27	23	13	20	12.4	76	12.4	7.0
80	VPX300R08005CA05225	31.75	32	17	26	17.4	76	12.7	8.0
80	VPX300R08005CA06330	31.75	32	17	26	17.4	76	12.7	8.0

ROTATING TOOLS

INSERTS

Work Material	P	Steels										Cutting Conditions (Guide) :					
	M	Stainless Steels										● : Stable Cutting	● : General Cutting	✦ : Unstable Cutting			
	K	Cast Irons										Honing :					
N	Non-ferrous Metals											E : Round	F : Sharp				
S	Heat Resistant Alloys, Titanium Alloys																
H	Hardened Steels																
Shape	Order Number	Class	Honing	Coated						Carbide	Dimensions (mm)					Geometry	
				MC5020	MP6120	MP6130	MP7130	MP9120	MP9130	VP15TF	TF15	L	RE	LE	S		BS
Low Cutting Resistance L Breaker	LOGU1207020PNER-L	G E	★	★	★	★	★	★	★	★	★		12.4	0.2	11.3	7.0	3.0
	LOGU1207040PNER-L	G E	●	●	●	●	●	●	●	●	★		12.4	0.4	11.3	7.0	2.8
	LOGU1207080PNER-L	G E	●	●	●	●	●	●	●	●	★		12.4	0.8	11.3	7.0	2.6
	LOGU1207100PNER-L	G E	★	★	★	★	★	★	★	★	★		12.4	1.0	11.3	7.0	2.5
	LOGU1207120PNER-L	G E	●	●	●	●	●	●	●	●	★		12.4	1.2	11.3	7.0	2.4
	LOGU1207160PNER-L	G E	●	●	●	●	●	●	●	●	★		12.4	1.6	11.3	7.0	1.8
	LOGU1207200PNER-L	G E	●	●	●	●	●	●	●	●	★		12.4	2.0	11.3	7.0	1.4
	LOGU1207240PNER-L	G E	●	●	●	●	●	●	●	●	★		12.4	2.4	11.3	7.0	1.2
	LOGU1207300PNER-L	G E	★	★	★	★	★	★	★	★	★		12.4	3.0	11.3	7.0	0.6
	LOGU1207320PNER-L	G E	●	●	●	●	●	●	●	●	★		12.4	3.2	11.3	7.0	0.4
	LOGU1207020PNFR-L	G F									★		12.4	0.2	11.3	7.0	3.0
	LOGU1207040PNFR-L	G F									●		12.4	0.4	11.3	7.0	2.8
	LOGU1207080PNFR-L	G F									●		12.4	0.8	11.3	7.0	2.6
	LOGU1207100PNFR-L	G F									★		12.4	1.0	11.3	7.0	2.5
	LOGU1207120PNFR-L	G F									●		12.4	1.2	11.3	7.0	2.4
	LOGU1207160PNFR-L	G F									●		12.4	1.6	11.3	7.0	1.8
	LOGU1207200PNFR-L	G F									●		12.4	2.0	11.3	7.0	1.4
	LOGU1207240PNFR-L	G F									●		12.4	2.4	11.3	7.0	1.2
	LOGU1207300PNFR-L	G F									★		12.4	3.0	11.3	7.0	0.6
	LOGU1207320PNFR-L	G F									●		12.4	3.2	11.3	7.0	0.4
General Use M Breaker	LOGU1207020PNER-M	G E	★	★	★	★	★	★	★	★	★		12.4	0.2	11.3	7.0	3.0
	LOGU1207040PNER-M	G E	●	●	●	●	●	●	●	●	★		12.4	0.4	11.3	7.0	2.8
	LOGU1207080PNER-M	G E	●	●	●	●	●	●	●	●	★		12.4	0.8	11.3	7.0	2.4
	LOGU1207100PNER-M	G E	★	★	★	★	★	★	★	★	★		12.4	1.0	11.3	7.0	2.3
	LOGU1207120PNER-M	G E	●	●	●	●	●	●	●	●	★		12.4	1.2	11.3	7.0	2.1
	LOGU1207160PNER-M	G E	●	●	●	●	●	●	●	●	★		12.4	1.6	11.3	7.0	1.7
	LOGU1207200PNER-M	G E	●	●	●	●	●	●	●	●	★		12.4	2.0	11.3	7.0	1.4
	LOGU1207240PNER-M	G E	●	●	●	●	●	●	●	●	★		12.4	2.4	11.3	7.0	1.0
	LOGU1207300PNER-M	G E	★	★	★	★	★	★	★	★	★		12.4	3.0	11.3	7.0	0.5
	LOGU1207320PNER-M	G E	●	●	●	●	●	●	●	●	★		12.4	3.2	11.3	7.0	0.3
	LOGU1207020PNFR-M	G F									★		12.4	0.2	11.3	7.0	3.0
	LOGU1207040PNFR-M	G F									●		12.4	0.4	11.3	7.0	2.8
	LOGU1207080PNFR-M	G F									●		12.4	0.8	11.3	7.0	2.4
	LOGU1207100PNFR-M	G F									★		12.4	1.0	11.3	7.0	2.3
	LOGU1207120PNFR-M	G F									●		12.4	1.2	11.3	7.0	2.1
	LOGU1207160PNFR-M	G F									●		12.4	1.6	11.3	7.0	1.7
	LOGU1207200PNFR-M	G F									●		12.4	2.0	11.3	7.0	1.4
	LOGU1207240PNFR-M	G F									●		12.4	2.4	11.3	7.0	1.0
	LOGU1207300PNFR-M	G F									★		12.4	3.0	11.3	7.0	0.5
	LOGU1207320PNFR-M	G F									●		12.4	3.2	11.3	7.0	0.3

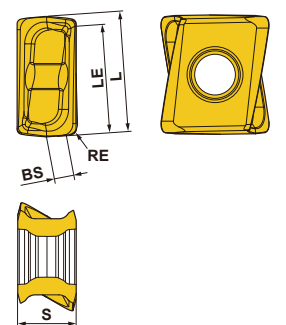

Right hand insert only.

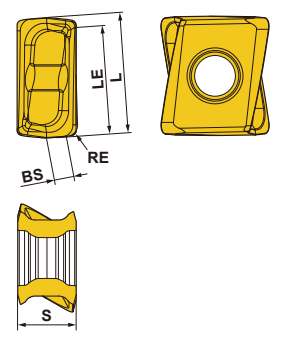

Right hand insert only.

● ★ = NEW

● : Inventory maintained. ★ : Inventory maintained in Japan.
(10 inserts in one case)

ROTATING TOOLS

K

NEW



Cutting Conditions (Guide) :

● : Stable Cutting ● : General Cutting ✖ : Unstable Cutting

CHIPBREAKER RECOMMENDATION

Chipbreaker Selection Table

Work Material	Properties	Cutting Conditions	Chipbreaker		Grade		
			1st Recommendation	2nd Recommendation	1st Recommendation	2nd Recommendation	
P	Mild Steel	Hardness ≤180HB	● ●	L	M	MP6120	VP15TF
			✖	M	L	MP6130	—
	Carbon Steel Alloy Steel Alloy Tool Steel	Hardness 180-350HB ≤350HB (Annealing)	● ●	L	M	MP6120	VP15TF
			● ●	M	L	MP6120	VP15TF
			✖	M	L	MP6130	—
	Pre-hardened Steel	Hardness 35—45HRC	● ●	M	L	MP6120	VP15TF
✖			M	L	MP6130	—	
M	Austenitic Stainless Steel	Hardness ≤280HB	● ●	L	M	MP7130	VP15TF
			✖	M	L	MP7130	—
		Hardness >200HB	● ●	L	M	MP7130	VP15TF
			✖	M	L	MP7130	—
	Duplex Stainless Steel	Hardness ≤280HB	● ●	L	M	MP7130	VP15TF
			✖	M	L	MP7130	—
	Ferritic and Martensitic Stainless Steel	—	● ●	L	M	MP7130	VP15TF
			✖	M	L	MP7130	—
	Precipitation Hardening Stainless Steel	Hardness <450HB	● ●	L	M	MP7130	VP15TF
			✖	M	L	MP7130	—
K	Gray Cast Iron	Tensile Strength ≤350MPa	● ●	M	L	MC5020	VP15TF
			✖	M	L	VP15TF	—
	Ductile Cast Iron	Tensile Strength ≤800MPa	● ●	M	L	MC5020	VP15TF
			✖	M	L	VP15TF	—
N	Aluminium Alloy	Content Si <5%	● ●	L	M	TF15	—
			✖	M	L	TF15	—
S	Titanium Alloy (Ti-6Al-4V, etc.)	—	● ●	L	M	MP9120	VP15TF
			✖	M	L	MP9130	—
	Titanium Alloy (Ti-5Al-5V-5Mo-3Cr, etc.)	—	● ●	L	M	MP9120	VP15TF
			✖	M	L	MP9130	—
	Heat Resistant Alloy	—	● ●	M	L	MP9120	VP15TF
✖			M	L	MP9130	—	
H	Hardened Steel	Hardness 40—55HRC	● ● ✖	M	—	VP15TF	—

K
ROTATING TOOLS

RECOMMENDED CUTTING CONDITIONS

Cutting Speed

(mm)

Work Material	Properties	Cutting Conditions	Grade	ae				Cutting Mode	
				≤0.25DC	0.25—0.5DC	0.5—0.75DC	DC(Slot)		
				Vc (m/min)					
P Mild Steel	Hardness ≤180HB	● ●	MP6120,VP15TF	140(100—190)	130(90—180)	100(70—120)	100(70—120)	Dry, Wet	
		● ●	MP6130	140(100—190)	130(90—180)	100(70—120)	100(70—120)	Dry, Wet	
	Carbon Steel Alloy Steel	Hardness 180—350HB	● ●	MP6120,VP15TF	120(90—140)	110(80—130)	100(70—120)	100(70—120)	Dry, Wet
			● ●	MP6130	120(90—140)	110(80—130)	100(70—120)	100(70—120)	Dry, Wet
	Pre-hardened Steel	Hardness 180—350HB	● ●	MP6120,VP15TF	100(80—120)	90(70—110)	80(60—100)	80(60—100)	Dry, Wet
			● ●	MP6130	100(80—120)	90(70—110)	80(60—100)	80(60—100)	Dry, Wet
M Austenitic Stainless Steel	Hardness ≤200HB	● ●	MP7130,VP15TF	120(100—150)	110(90—140)	90(70—120)	90(70—120)	Dry, Wet	
		● ●	MP7130	120(100—150)	110(90—140)	90(70—120)	90(70—120)	Dry, Wet	
	Hardness >200HB	● ●	MP7130,VP15TF	100(80—130)	90(70—120)	70(50—100)	70(50—100)	Dry, Wet	
		● ●	MP7130	100(80—130)	90(70—120)	70(50—100)	70(50—100)	Dry, Wet	
	Ferritic and Martensitic Stainless Steel	—	● ●	MP7130,VP15TF	120(100—150)	110(90—140)	90(70—120)	90(70—120)	Dry, Wet
			● ●	MP7130	120(100—150)	110(90—140)	90(70—120)	90(70—120)	Dry, Wet
Duplex Stainless Steel	Hardness ≤280HB	● ●	MP7130,VP15TF	100(80—130)	90(70—120)	70(50—100)	70(50—100)	Dry, Wet	
		● ●	MP7130	100(80—130)	90(70—120)	70(50—100)	70(50—100)	Dry, Wet	
Precipitation Hardening Stainless Steel	Hardness <450HB	● ●	MP7130,VP15TF	90(70—120)	80(60—110)	60(40—90)	60(40—90)	Dry, Wet	
		● ●	MP7130	90(70—120)	80(60—110)	60(40—90)	60(40—90)	Dry, Wet	
K Gray Cast Iron	Tensile Strength ≤350MPa	● ●	MC5020	180(160—220)	170(150—210)	150(130—190)	150(130—190)	Dry, Wet	
		● ●	VP15TF	130(100—150)	120(90—140)	100(80—120)	100(80—120)	Dry, Wet	
	Ductile Cast Iron	Tensile Strength ≤800MPa	● ●	MC5020	160(140—180)	150(130—170)	130(110—150)	130(110—150)	Dry, Wet
			● ●	VP15TF	110(80—140)	100(70—130)	80(60—120)	80(60—120)	Dry, Wet
N Aluminium Alloy	Content Si <5%	● ●	TF15	600(400—1000)	600(400—1000)	600(400—1000)	600(400—1000)	Dry, Wet	
S Titanium Alloy (Ti-6Al-4V etc.)	—	● ●	MP9120	50(40—70)	50(40—70)	50(40—70)	50(40—70)	Wet	
		● ●	VP15TF	50(40—70)	50(40—70)	50(40—70)	50(40—70)	Wet	
		● ●	MP9130	50(40—70)	50(40—70)	50(40—70)	50(40—70)	Wet	
	Titanium Alloy (Ti-6Al-5V-5Mo-3Cr etc.)	—	● ●	MP9120	30(20—40)	30(20—40)	30(20—40)	30(20—40)	Wet
			● ●	VP15TF	30(20—40)	30(20—40)	30(20—40)	30(20—40)	Wet
			● ●	MP9130	30(20—40)	30(20—40)	30(20—40)	30(20—40)	Wet
	Heat Resistant Alloy	—	● ●	MP9120	40(30—60)	40(30—60)	40(30—60)	40(30—60)	Wet
			● ●	VP15TF	40(30—60)	40(30—60)	40(30—60)	40(30—60)	Wet
			● ●	MP9130	40(30—60)	40(30—60)	40(30—60)	40(30—60)	Wet

Note 1) If there is chatter, insert chipping, etc. during machining, alter conditions accordingly.

Note 2) Chattering and vibrations are more likely under the following circumstances. Use a cut and feed per tooth that are at minimum recommended conditions or below.

- When tool overhang is long
- Rigidity of machine, work material or attachment of work material is low
- At a corner radius during pocket milling

Note 3) A type with fewer teeth is recommended when the depth of cut in the radial direction (ae) is 0.5 DC or more.

Note 4) Wet cutting is recommended, when focusing on the surface finish. (Service life is shorter than for dry cutting.)

Note 5) When using higher than recommended cutting conditions, or for long periods of time, the clamp screw may become fatigued and break during machining. Please change out the clamp screw periodically.

K

ROTATING TOOLS

Cutting Conditions (Guide) :

● : Stable Cutting ● : General Cutting ✖ : Unstable Cutting

Depth of Cut / Feed per Tooth

(mm)

Work Material	Properties	ae	Cutting Conditions	DC				
				ø40		ø50-ø80		
				ap	fz (mm/t.)	ap	fz (mm/t.)	
P	Mild Steel	≤0.25DC	● ● ✖	≤APMX	0.15(0.10-0.20)	≤APMX	0.18(0.10-0.25)	
		0.25-0.5DC	● ● ✖	≤APMX	0.13(0.10-0.15)	≤31	0.15(0.10-0.20)	
		0.5-0.75DC	● ● ✖	≤21	0.10(0.08-0.12)	≤21	0.13(0.10-0.15)	
		DC(Slot)	● ● ✖	≤5	0.08(0.06-0.10)	≤5	0.10(0.08-0.12)	
	Carbon Steel Alloy Steel	Hardness 180-280HB	≤0.25DC	● ● ✖	≤APMX	0.15(0.10-0.20)	≤APMX	0.18(0.10-0.25)
			0.25-0.5DC	● ● ✖	≤APMX	0.13(0.10-0.15)	≤31	0.15(0.10-0.20)
			0.5-0.75DC	● ● ✖	≤21	0.10(0.08-0.12)	≤21	0.13(0.10-0.15)
			DC(Slot)	● ● ✖	≤5	0.08(0.06-0.10)	≤5	0.10(0.08-0.12)
	Carbon Steel Alloy Steel	Hardness 280-350HB	≤0.25DC	● ● ✖	≤APMX	0.13(0.10-0.15)	≤APMX	0.15(0.10-0.20)
			0.25-0.5DC	● ● ✖	≤APMX	0.10(0.08-0.12)	≤31	0.13(0.10-0.15)
			0.5-0.75DC	● ● ✖	≤21	0.08(0.06-0.10)	≤21	0.10(0.08-0.12)
			DC(Slot)	● ● ✖	≤5	0.08(0.06-0.10)	≤5	0.08(0.06-0.10)
	Pre-hardened Steel	Hardness 35-45HRC	≤0.25DC	● ● ✖	≤APMX	0.13(0.10-0.15)	≤APMX	0.15(0.10-0.20)
			0.25-0.5DC	● ● ✖	≤APMX	0.10(0.08-0.12)	≤31	0.13(0.10-0.15)
			0.5-0.75DC	● ● ✖	≤21	0.08(0.06-0.10)	≤21	0.10(0.08-0.12)
			DC(Slot)	● ● ✖	≤5	0.08(0.06-0.10)	≤5	0.08(0.06-0.10)
M	Austenitic Stainless Steel	≤0.25DC	● ● ✖	≤APMX	0.15(0.10-0.20)	≤APMX	0.15(0.10-0.20)	
			● ● ✖	≤APMX	0.12(0.08-0.15)	≤APMX	0.12(0.08-0.15)	
		0.25-0.5DC	● ● ✖	≤APMX	0.12(0.08-0.15)	≤31	0.12(0.08-0.15)	
			● ● ✖	≤APMX	0.10(0.08-0.12)	≤31	0.10(0.08-0.12)	
		0.5-0.75DC	● ● ✖	≤21	0.10(0.08-0.12)	≤21	0.10(0.08-0.12)	
			● ● ✖	≤21	0.08(0.06-0.10)	≤21	0.08(0.06-0.10)	
		DC(Slot)	● ● ✖	≤5	0.08(0.06-0.10)	≤5	0.08(0.06-0.10)	
			● ● ✖	≤5	0.07(0.06-0.08)	≤5	0.07(0.06-0.08)	
	Ferritic and Martensitic Stainless Steel	Hardness ≤200HB	≤0.25DC	● ● ✖	≤APMX	0.15(0.10-0.20)	≤APMX	0.15(0.10-0.20)
				● ● ✖	≤APMX	0.12(0.08-0.15)	≤APMX	0.12(0.08-0.15)
			0.25-0.5DC	● ● ✖	≤APMX	0.12(0.08-0.15)	≤31	0.12(0.08-0.15)
				● ● ✖	≤APMX	0.10(0.08-0.12)	≤31	0.10(0.08-0.12)
		0.5-0.75DC	● ● ✖	≤21	0.10(0.08-0.12)	≤21	0.10(0.08-0.12)	
			● ● ✖	≤21	0.08(0.06-0.10)	≤21	0.08(0.05-0.10)	
		DC(Slot)	● ● ✖	≤5	0.08(0.06-0.10)	≤5	0.08(0.05-0.10)	
			● ● ✖	≤5	0.07(0.06-0.08)	≤5	0.07(0.05-0.08)	
	Duplex Stainless Steel	Hardness ≤280HB	≤0.25DC	● ● ✖	≤APMX	0.15(0.10-0.20)	≤APMX	0.15(0.10-0.20)
				● ● ✖	≤APMX	0.12(0.08-0.15)	≤APMX	0.12(0.08-0.15)
			0.25-0.5DC	● ● ✖	≤APMX	0.12(0.08-0.15)	≤31	0.12(0.08-0.15)
				● ● ✖	≤APMX	0.10(0.08-0.12)	≤31	0.10(0.08-0.12)
		0.5-0.75DC	● ● ✖	≤21	0.10(0.08-0.12)	≤21	0.10(0.08-0.12)	
			● ● ✖	≤21	0.08(0.06-0.10)	≤21	0.08(0.06-0.10)	
		DC(Slot)	● ● ✖	≤5	0.08(0.06-0.10)	≤5	0.08(0.06-0.10)	
			● ● ✖	≤5	0.07(0.06-0.08)	≤5	0.07(0.06-0.08)	
Precipitation Hardening Stainless Steel	Hardness <450HB	≤0.25DC	● ● ✖	≤APMX	0.13(0.10-0.15)	≤APMX	0.13(0.10-0.15)	
			● ● ✖	≤APMX	0.10(0.08-0.12)	≤APMX	0.10(0.08-0.12)	
		0.25-0.5DC	● ● ✖	≤APMX	0.10(0.08-0.12)	≤31	0.10(0.08-0.12)	
			● ● ✖	≤APMX	0.10(0.08-0.12)	≤31	0.10(0.08-0.12)	
	0.5-0.75DC	● ● ✖	≤21	0.08(0.06-0.10)	≤21	0.08(0.05-0.10)		
		● ● ✖	≤21	0.07(0.06-0.08)	≤21	0.07(0.05-0.08)		
	DC(Slot)	● ● ✖	≤5	0.08(0.06-0.10)	≤5	0.08(0.05-0.10)		
		● ● ✖	≤5	0.07(0.06-0.08)	≤5	0.07(0.06-0.08)		

K

ROTATING TOOLS

ROTATING TOOLS

Cutting Conditions (Guide) :

● : Stable Cutting ● : General Cutting ✖ : Unstable Cutting

RECOMMENDED CUTTING CONDITIONS

■ Depth of Cut / Feed per Tooth

(mm)

Work Material	Properties	ae	Cutting Conditions	DC					
				ø40		ø50-ø80			
				ap	fz (mm/t.)	ap	fz (mm/t.)		
K Gray Cast Iron	Tensile Strength ≤350MPa	≤0.25DC	● ● ✖	≤APMX	0.15 (0.10-0.20)	≤APMX	0.18 (0.10-0.25)		
			● ● ✖	≤APMX	0.12 (0.08-0.15)	≤APMX	0.15 (0.10-0.20)		
		0.25-0.5DC	● ● ✖	≤APMX	0.12 (0.08-0.15)	≤31	0.15 (0.10-0.20)		
			● ● ✖	≤APMX	0.10 (0.08-0.12)	≤31	0.13 (0.10-0.15)		
		0.5-0.75DC	● ● ✖	≤21	0.10 (0.08-0.12)	≤21	0.13 (0.10-0.15)		
			● ● ✖	≤21	0.08 (0.06-0.10)	≤21	0.10 (0.08-0.12)		
		DC(Slot)	● ● ✖	≤5	0.08 (0.06-0.10)	≤5	0.12 (0.08-0.15)		
			● ● ✖	≤5	0.07 (0.06-0.08)	≤5	0.08 (0.06-0.10)		
		Ductile Cast Iron	-	≤0.25DC	● ● ✖	≤APMX	0.15 (0.10-0.20)	≤APMX	0.15 (0.10-0.20)
					● ● ✖	≤APMX	0.13 (0.10-0.15)	≤APMX	0.13 (0.10-0.15)
0.25-0.5DC	● ● ✖			≤APMX	0.13 (0.10-0.15)	≤31	0.13 (0.10-0.15)		
	● ● ✖			≤APMX	0.10 (0.08-0.12)	≤31	0.10 (0.08-0.12)		
0.5-0.75DC	● ● ✖			≤21	0.10 (0.08-0.12)	≤21	0.10 (0.08-0.12)		
	● ● ✖			≤21	0.08 (0.06-0.10)	≤21	0.08 (0.06-0.10)		
DC(Slot)	● ● ✖			≤5	0.08 (0.06-0.10)	≤5	0.08 (0.06-0.10)		
	● ● ✖			≤5	0.07 (0.06-0.08)	≤5	0.07 (0.06-0.08)		
N Aluminium Alloy	Content Si < 5%			≤0.25DC	● ● ✖	≤APMX	0.18 (0.10-0.25)	≤APMX	0.18 (0.10-0.25)
					● ● ✖	≤APMX	0.15 (0.10-0.20)	≤APMX	0.15 (0.10-0.20)
		0.25-0.5DC	● ● ✖	≤APMX	0.15 (0.10-0.20)	≤31	0.15 (0.10-0.20)		
			● ● ✖	≤APMX	0.13 (0.10-0.15)	≤31	0.13 (0.10-0.15)		
		0.5-0.75DC	● ● ✖	≤21	0.11 (0.06-0.15)	≤21	0.12 (0.08-0.15)		
			● ● ✖	≤21	0.11 (0.06-0.15)	≤21	0.12 (0.08-0.15)		
		DC(Slot)	● ● ✖	≤5	0.11 (0.06-0.15)	≤5	0.12 (0.08-0.15)		
			● ● ✖	≤5	0.09 (0.06-0.12)	≤5	0.10 (0.08-0.12)		
		S Titanium Alloy (Ti-6Al-4V etc.)	-	≤0.25DC	● ● ✖	≤APMX	0.12 (0.08-0.15)	≤APMX	0.12 (0.08-0.15)
				0.25-0.5DC	● ● ✖	≤APMX	0.10 (0.08-0.12)	≤31	0.10 (0.08-0.12)
0.5-0.75DC	● ● ✖			≤21	0.08 (0.06-0.10)	≤21	0.08 (0.06-0.10)		
DC(Slot)	● ● ✖			≤5	0.08 (0.06-0.10)	≤5	0.08 (0.06-0.10)		
Titanium Alloy (Ti-5Al-5V-5Mo-3Cr etc.)	-		≤0.25DC	● ● ✖	≤APMX	0.10 (0.08-0.12)	≤APMX	0.10 (0.08-0.12)	
			0.25-0.5DC	● ● ✖	≤APMX	0.10 (0.08-0.12)	≤31	0.10 (0.08-0.12)	
			0.5-0.75DC	● ● ✖	≤21	0.08 (0.06-0.10)	≤21	0.08 (0.06-0.10)	
			DC(Slot)	● ● ✖	≤5	0.08 (0.06-0.10)	≤5	0.08 (0.06-0.10)	
Heat Resistant Alloy	-		≤0.25DC	● ● ✖	≤APMX	0.10 (0.08-0.12)	≤APMX	0.10 (0.08-0.12)	
			0.25-0.5DC	● ● ✖	≤APMX	0.10 (0.08-0.12)	≤31	0.10 (0.08-0.12)	
			0.5-0.75DC	● ● ✖	≤21	0.08 (0.06-0.10)	≤21	0.08 (0.06-0.10)	
			DC(Slot)	● ● ✖	≤5	0.08 (0.06-0.10)	≤5	0.08 (0.06-0.10)	

■ Ramping / Helical Cutting

● Ramping

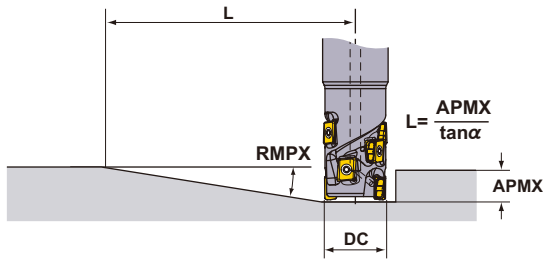

● Helical Cutting

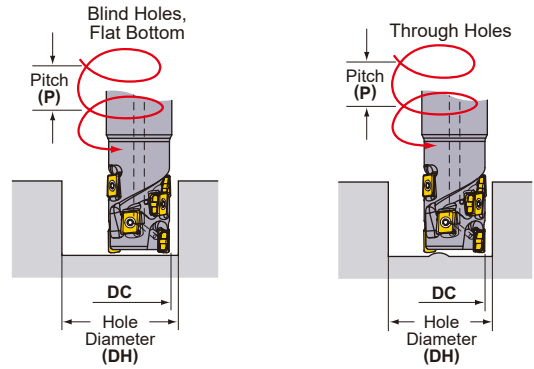

Refer to the table below for cutting conditions. For feed per tooth and cutting speed, follow the cutting conditions for slot milling.

DC (mm)	RE (mm)	Ramping		Helical Cutting (Blind Hole, Flat Bottom)				Helical Cutting (Through Hole)	
		RMPX	L (mm) *	DH max. (mm)	P max. (mm)	DH min. (mm)	P max. (mm)	DH min. (mm)	P max. (mm)
40	0.2	1.06°	595	78.8	2.3	72.7	1.9	66.5	1.5
	0.4	1.06°	595	78.4	2.2	72.7	1.9	66.5	1.5
	0.8	1.06°	595	77.6	2.2	72.7	1.9	66.5	1.5
	1.0	1.06°	595	77.2	2.2	72.7	1.9	66.5	1.5
	1.2	1.06°	595	76.8	2.1	72.7	1.9	66.5	1.5
	1.6	1.06°	595	76.0	2.1	72.7	1.9	66.5	1.5
	2.0	1.06°	595	75.2	2.0	72.7	1.9	66.5	1.5
	2.4	1.06°	595	74.4	2.0	72.7	1.9	66.5	1.5
	3.0	1.06°	595	73.2	1.9	72.7	1.9	66.5	1.5
3.2	1.06°	595	72.8	1.9	72.7	1.9	66.5	1.5	
50	0.2	0.79°	798	98.8	2.1	92.7	1.8	86.5	1.6
	0.4	0.79°	798	98.4	2.1	92.7	1.8	86.5	1.6
	0.8	0.79°	798	97.6	2.1	92.7	1.8	86.5	1.6
	1.0	0.79°	798	97.2	2.0	92.7	1.8	86.5	1.6
	1.2	0.79°	798	96.8	2.0	92.7	1.8	86.5	1.6
	1.6	0.79°	798	96.0	2.0	92.7	1.8	86.5	1.6
	2.0	0.79°	798	95.2	2.0	92.7	1.8	86.5	1.6
	2.4	0.79°	798	94.4	1.9	92.7	1.8	86.5	1.6
	3.0	0.79°	798	93.2	1.9	92.7	1.8	86.5	1.6
3.2	0.79°	798	92.8	1.9	92.7	1.8	86.5	1.6	
63	0.2	0.6°	1051	124.8	2.0	118.7	1.8	112.5	1.6
	0.4	0.6°	1051	124.4	2.0	118.7	1.8	112.5	1.6
	0.8	0.6°	1051	123.6	2.0	118.7	1.8	112.5	1.6
	1.0	0.6°	1051	123.2	2.0	118.7	1.8	112.5	1.6
	1.2	0.6°	1051	122.8	2.0	118.7	1.8	112.5	1.6
	1.6	0.6°	1051	122.0	1.9	118.7	1.8	112.5	1.6
	2.0	0.6°	1051	121.2	1.9	118.7	1.8	112.5	1.6
	2.4	0.6°	1051	120.4	1.9	118.7	1.8	112.5	1.6
	3.0	0.6°	1051	119.2	1.9	118.7	1.8	112.5	1.6
3.2	0.6°	1051	118.8	1.8	118.7	1.8	112.5	1.6	
80	0.2	0.45°	1401	158.8	1.9	152.6	1.8	146.5	1.6
	0.4	0.45°	1401	158.4	1.9	152.7	1.8	146.5	1.6
	0.8	0.45°	1401	157.6	1.9	152.7	1.8	146.5	1.6
	1.0	0.45°	1401	157.2	1.9	152.7	1.8	146.5	1.6
	1.2	0.45°	1401	156.8	1.9	152.7	1.8	146.5	1.6
	1.6	0.45°	1401	156.0	1.9	152.7	1.8	146.5	1.6
	2.0	0.45°	1401	155.2	1.9	152.7	1.8	146.5	1.6
	2.4	0.45°	1401	154.4	1.8	152.7	1.8	146.5	1.6
	3.0	0.45°	1401	153.2	1.8	152.7	1.8	146.5	1.6
3.2	0.45°	1401	152.8	1.8	152.7	1.8	146.5	1.6	

Note 1) When machining a highly ductile work material with the ramping angles in the table above, chips may be elongated.

* Shows the distance until a maximum depth of cut of 11 mm is achieved at the maximum ramping angle $L (= 11/\tan \alpha)$.

For Plunging and Drilling

See the tables to the right for cutting conditions. Follow the cutting conditions for slot milling regarding feed per tooth and cutting speed.

● Plunging

ROTATING TOOLS

K

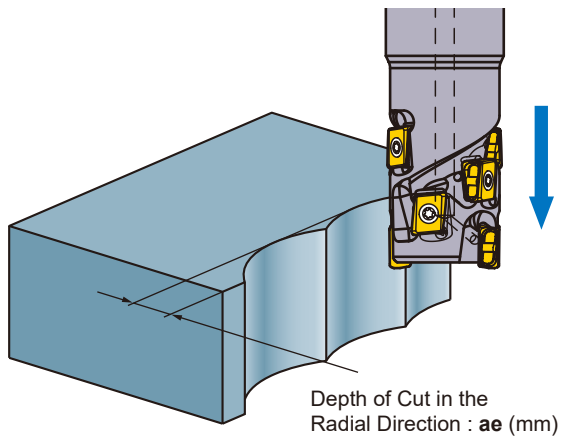

DC (mm)	ae max. (mm)
40	6.7
50	6.7
63	6.7
80	6.7

Note 1) No step feed necessary.

● Drilling

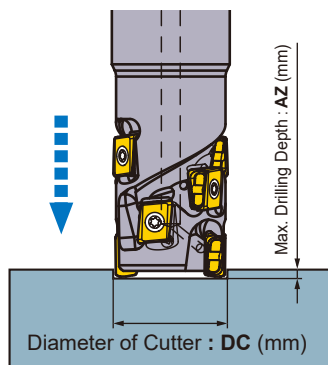

DC (mm)	AZ max. (mm)
40	0.55
50	0.55
63	0.55
80	0.55

Note 1) Exercise due caution as chips scatter easily.

Note 2) Use compressed air to eliminate chips (or coolant for when machining aluminium alloy).

MULTI FUNCTIONAL MILLING

90°
KAPR



APX3000

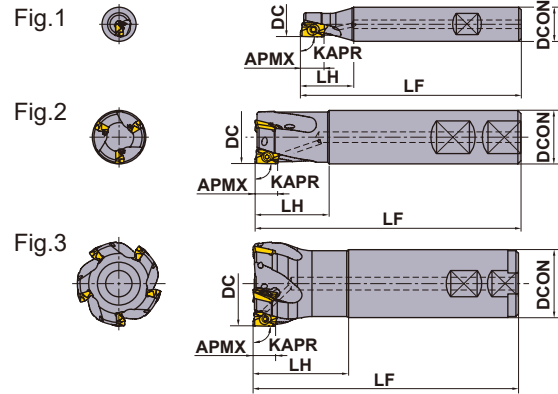

Right hand tool holder only.

WELDON SHANK TYPE

KAPR : 90°
With Coolant Hole

DC (mm)	Order Number	Stock R	Number of Teeth	Dimensions(mm)			WT* (kg)	APMX (mm)	RMPX	RPMX (min ⁻¹)	Fig.	Insert Type
				DCON	LF	LH						
12	APX3000R121WA16SA	●	1	16	85	25	0.10	10	6.0°	10500	1	AO-T12
14	APX3000R141WA16SA	●	1	16	85	25	0.11	10	6.0°	9000	1	AO-T12
16	APX3000R162WA16SA	●	2	16	85	25	0.11	10	11.3°	20900	2	AO-T12
18	APX3000R182WA16SA	●	2	16	85	25	0.11	10	8.6°	19600	3	AO-T12
18	APX3000R182WA16LA	●	2	16	120	25	0.16	10	8.6°	19600	3	AO-T12
20	APX3000R202WA20SA	●	2	20	100	30	0.21	10	6.9°	18500	2	AO-T12
20	APX3000R203WA20SA	●	3	20	100	30	0.21	10	6.9°	18500	2	AO-T12
20	APX3000R202WA20LA	●	2	20	150	60	0.32	10	6.9°	18500	2	AO-T12
22	APX3000R223WA20SA	●	3	20	115	30	0.25	10	5.7°	17600	3	AO-T12
22	APX3000R222WA20LA	●	2	20	150	30	0.34	10	5.7°	17600	3	AO-T12
25	APX3000R252WA25SA	●	2	25	115	35	0.38	10	4.6°	16400	2	AO-T12
25	APX3000R253WA25SA	●	3	25	115	35	0.38	10	4.6°	16400	2	AO-T12
25	APX3000R254WA25SA	●	4	25	115	35	0.38	10	4.6°	16400	2	AO-T12
25	APX3000R253WA25LA	●	3	25	170	70	0.51	10	4.6°	16400	2	AO-T12
28	APX3000R284WA25SA	●	4	25	115	35	0.40	10	3.8°	15500	3	AO-T12
28	APX3000R283WA25LA	●	3	25	170	35	0.61	10	3.8°	15500	3	AO-T12
30	APX3000R304WA32SA	●	4	32	125	45	0.64	10	3.4°	14900	1	AO-T12
32	APX3000R323WA32SA	●	3	32	125	45	0.68	10	3.1°	14400	2	AO-T12
32	APX3000R324WA32SA	●	4	32	125	45	0.67	10	3.1°	14400	2	AO-T12
32	APX3000R325WA32SA	●	5	32	125	45	0.68	10	3.1°	14400	2	AO-T12
35	APX3000R353WA32LA	●	3	32	190	45	1.11	10	2.7°	13700	3	AO-T12
40	APX3000R403WA32SA	□	3	32	125	45	0.75	10	2.2°	12800	3	AO-T12
40	APX3000R405WA32SA	●	5	32	125	45	0.75	10	2.2°	12800	3	AO-T12
40	APX3000R406WA32SA	●	6	32	125	45	0.76	10	2.2°	12800	3	AO-T12

Note 1) When using inserts with corner radius RE ≥ 2.4mm, machining of the holder is required as shown on page K137.

Note 2) The maximum allowable spindle speeds (RPMX) are set to ensure tool and insert stability.

Note 3) When using the tool at high spindle speeds, ensure that the tool and arbor are correctly balanced.

* WT : Tool Weight

K

ROTATING TOOLS

● : Inventory maintained. □ : Non stock, produced to order only.

SPARE PARTS > N001
TECHNICAL DATA > P001

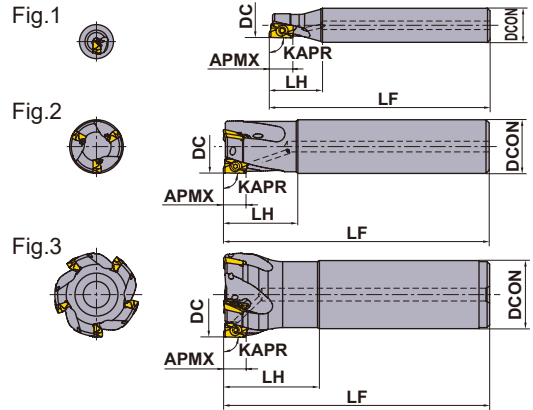

Right hand tool holder only.

STRAIGHT SHANK TYPE

KAPR : 90°
With Coolant Hole

DC (mm)	Order Number	Stock R	Number of Teeth	Dimensions(mm)			WT* (kg)	APMX (mm)	RMPX	RPMX (min ⁻¹)	Fig.	Insert Type
				DCON	LF	LH						
12	APX3000R121SA16SA	★	1	16	85	25	0.10	10	6.0°	10500	1	AO○T12
14	APX3000R141SA16SA	★	1	16	85	25	0.11	10	6.0°	9000	1	AO○T12
16	APX3000R162SA16SA	●	2	16	85	25	0.11	10	11.3°	20900	2	AO○T12
18	APX3000R182SA16SA	★	2	16	85	25	0.11	10	8.6°	19600	3	AO○T12
18	APX3000R182SA16LA	●	2	16	120	25	0.16	10	8.6°	19600	3	AO○T12
18	APX3000R182SA16ELA	●	2	16	180	25	0.25	10	8.6°	19600	3	AO○T12
20	APX3000R202SA20SA	★	2	20	100	30	0.21	10	6.9°	18500	2	AO○T12
20	APX3000R203SA20SA	●	3	20	100	30	0.21	10	6.9°	18500	2	AO○T12
20	APX3000R202SA20LA	●	2	20	150	60	0.32	10	6.9°	18500	2	AO○T12
20	APX3000R202SA20ELA	★	2	20	200	70	0.42	10	6.9°	18500	2	AO○T12
22	APX3000R223SA20SA	●	3	20	115	30	0.25	10	5.7°	17600	3	AO○T12
22	APX3000R222SA20LA	●	2	20	150	30	0.34	10	5.7°	17600	3	AO○T12
22	APX3000R222SA20ELA	★	2	20	200	30	0.45	10	5.7°	17600	3	AO○T12
25	APX3000R252SA25SA	★	2	25	115	35	0.38	10	4.6°	16400	2	AO○T12
25	APX3000R253SA25SA	★	3	25	115	35	0.38	10	4.6°	16400	2	AO○T12
25	APX3000R254SA25SA	●	4	25	115	35	0.38	10	4.6°	16400	2	AO○T12
25	APX3000R252SA25LA	★	2	25	170	70	0.51	10	4.6°	16400	2	AO○T12
25	APX3000R253SA25LA	★	3	25	170	70	0.51	10	4.6°	16400	2	AO○T12
25	APX3000R252SA25ELA	★	2	25	220	80	0.75	10	4.6°	16400	2	AO○T12
25	APX3000R253SA25ELA	★	3	25	220	80	0.75	10	4.6°	16400	2	AO○T12
28	APX3000R284SA25SA	★	4	25	115	35	0.40	10	3.8°	15500	3	AO○T12
28	APX3000R282SA25LA	★	2	25	170	35	0.61	10	3.8°	15500	3	AO○T12
28	APX3000R283SA25LA	★	3	25	170	35	0.61	10	3.8°	15500	3	AO○T12
28	APX3000R282SA25ELA	★	2	25	220	35	0.80	10	3.8°	15500	3	AO○T12
28	APX3000R283SA25ELA	★	3	25	220	35	0.79	10	3.8°	15500	3	AO○T12
30	APX3000R304SA32SA	★	4	32	125	45	0.64	10	3.4°	14900	2	AO○T12
32	APX3000R323SA32SA	★	3	32	125	45	0.68	10	3.1°	14400	2	AO○T12
32	APX3000R324SA32SA	★	4	32	125	45	0.67	10	3.1°	14400	2	AO○T12
32	APX3000R325SA32SA	★	5	32	125	45	0.68	10	3.1°	14400	2	AO○T12
32	APX3000R322SA32LA	★	2	32	190	90	1.07	10	3.1°	14400	2	AO○T12
32	APX3000R323SA32LA	★	3	32	190	90	1.05	10	3.1°	14400	2	AO○T12
32	APX3000R322SA32ELA	★	2	32	260	100	1.47	10	3.1°	14400	2	AO○T12
32	APX3000R323SA32ELA	★	3	32	260	100	1.45	10	3.1°	14400	2	AO○T12
35	APX3000R352SA32LA	★	2	32	190	45	1.12	10	2.7°	13700	3	AO○T12
35	APX3000R353SA32LA	★	3	32	190	45	1.11	10	2.7°	13700	3	AO○T12
35	APX3000R352SA32ELA	★	2	32	260	45	1.53	10	2.7°	13700	3	AO○T12
35	APX3000R353SA32ELA	★	3	32	260	45	1.52	10	2.7°	13700	3	AO○T12
40	APX3000R403SA32SA	★	3	32	125	45	0.75	10	2.2°	12800	3	AO○T12
40	APX3000R405SA32SA	★	5	32	125	45	0.75	10	2.2°	12800	3	AO○T12
40	APX3000R406SA32SA	★	6	32	125	45	0.76	10	2.2°	12800	3	AO○T12
50	APX3000R507SA32SA	★	7	32	125	45	0.90	10	1.7°	11300	3	AO○T12
63	APX3000R638SA32SA	★	8	32	125	45	1.04	10	1.3°	10000	3	AO○T12

Note 1) When using inserts with corner radius RE ≥ 2.4mm, machining of the holder is required as shown on page K137.

Note 2) The maximum allowable spindle speeds (RPMX) are set to ensure tool and insert stability.

Note 3) When using the tool at high spindle speeds, ensure that the tool and arbor are correctly balanced.

* WT : Tool Weight

● : Inventory maintained. ★ : Inventory maintained in Japan.

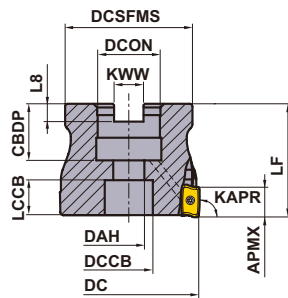

Right hand tool holder only.

ARBOR TYPE

KAPR :90°

GAMP:+7°—+21° GAMF:+15°—+27°

With Coolant Hole

DC (mm)	Set Bolt	Geometry
32, 40	HSC08030H	
50, 63	HSC10030H	
80	HSC12035H	
100	HSC16040H	

DC (mm)	Order Number	Stock	Number of Teeth	Dimensions(mm)		WT* (kg)	APMX (mm)	RMPX	RPMX (min ⁻¹)	Insert Type
				LF	DCON					
32	APX3000-032A05RA	●	5	40	16	0.2	10	3.1°	14400	AO-T12
40	APX3000-040A06RA	●	6	40	16	0.3	10	2.2°	12800	AO-T12
50	APX3000-050A07RA	●	7	40	22	0.4	10	1.7°	11300	AO-T12
63	APX3000-063A08RA	●	8	40	22	0.7	10	1.3°	10000	AO-T12
80	APX3000-080A09RA	●	9	50	27	1.3	10	1.0°	8800	AO-T12
100	APX3000-100A11RA	●	11	63	32	2.2	10	0.8°	7800	AO-T12

Note 1) When using inserts with corner radius RE ≥ 2.4mm, machining of the holder is required as shown on page K137.

Note 2) The maximum allowable spindle speeds (RPMX) are set to ensure tool and insert stability.

Note 3) When using the tool at high spindle speeds, ensure that the tool and arbor are correctly balanced.

* WT : Tool Weight

MOUNTING DIMENSIONS

DC (mm)	Order Number	Dimensions(mm)							
		DCON	CBDP	DAH	DCCB	LCCB	DCSFMS	KWW	L8
32	APX3000-032A05RA	16	18	9	14	10.22	30	8.4	5.6
40	APX3000-040A06RA	16	18	9	14	10.35	34	8.4	5.6
50	APX3000-050A07RA	22	20	11	17	12.35	45	10.4	6.3
63	APX3000-063A08RA	22	20	11	17	12.35	55	10.4	6.3
80	APX3000-080A09RA	27	23	13	20	16.35	70	12.4	7
100	APX3000-100A11RA	32	26	17	26	26.35	80	14.4	8

ROTATING TOOLS

ROTATING TOOLS

K

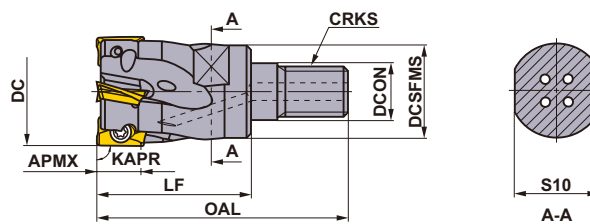
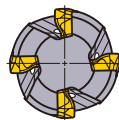

SCREW-IN TYPE

KAPR : 90°
With Coolant Hole

Right hand tool holder only.



DC (mm)	Order Number	Stock R	Number of Teeth	Dimensions(mm)						WT* (kg)	APMX (mm)	RMPX	Insert Type
				DCON	DCSFMS	OAL	LF	S10	CRKS				
16	APX3000R162M08A	●	2	8.5	13	48	30	10	M8	0.1	10	11.3°	AO-T12
18	APX3000R182M08A30	★	2	8.5	13	48	30	10	M8	0.1	10	8.6°	AO-T12
20	APX3000R203M10A	●	3	10.5	18	49	30	14	M10	0.1	10	6.9°	AO-T12
22	APX3000R223M10A30	★	3	10.5	18	49	30	14	M10	0.1	10	5.7°	AO-T12
25	APX3000R254M12A	●	4	12.5	21	57	35	19	M12	0.2	10	4.6°	AO-T12
28	APX3000R284M12A35	★	4	12.5	21	57	35	19	M12	0.2	10	3.8°	AO-T12
30	APX3000R304M16A40	★	4	17	29	63	40	24	M16	0.3	10	3.4°	AO-T12
32	APX3000R325M16A	●	5	17	29	63	40	24	M16	0.3	10	3.1°	AO-T12
35	APX3000R355M16A40	★	5	17	29	63	40	24	M16	0.3	10	2.7°	AO-T12
40	APX3000R406M16A	●	6	17	29	63	40	24	M16	0.3	10	2.2°	AO-T12

Note 1) When using inserts with corner radius $RE \geq 2.4\text{mm}$, machining of the holder is required as shown on page K137.

Note 2) For screw-in type arbors, refer to page K244.

* WT : Tool Weight

SPARE PARTS





DC (mm)	Tool Holder Type	DC (mm)	Tool Holder Type			
				Clamp Screw *	Wrench	Anti-seize Lubricant
12	APX3000R12	14	APX3000R14	TPS25	TIP07F	MK1KS
16	APX3000R16	18	APX3000R18	TPS25	TIP07F	MK1KS
20	APX3000R20			TPS25	TIP07F	MK1KS
22	APX3000R22	25	APX3000R25	TPS25-1	TIP07F	MK1KS
28	APX3000R28	30	APX3000R30	TPS25-1	TIP07F	MK1KS
32	APX3000R32	32	APX3000-032	TPS25-1	TIP07F	MK1KS
35	APX3000R35			TPS25-1	TIP07F	MK1KS
40	APX3000R40	40	APX3000-040	TPS25-1	TIP07F	MK1KS
50	APX3000R50	50	APX3000-050	TPS25-1	TIP07F	MK1KS
63	APX3000R63	63	APX3000-063	TPS25-1	TIP07F	MK1KS
80	APX3000-080			TPS25-1	TIP07F	MK1KS
100	APX3000-100			TPS25-1	TIP07F	MK1KS

* Clamp Torque (N · m) : TPS25 = 1.0, TPS25-1 = 1.0

● : Inventory maintained. ★ : Inventory maintained in Japan.

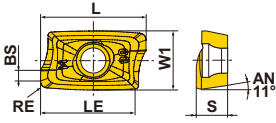
(10 inserts in one case)

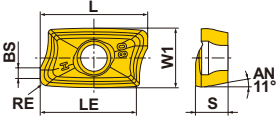
INSERTS

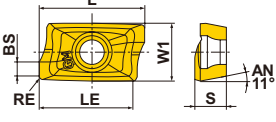
Work Material	P	Steels											Cutting Conditions (Guide) :						
	M	Stainless Steels											● : Stable Cutting ● : General Cutting ⊕ : Unstable Cutting						
Work Material	K	Cast Irons											Honing :						
	N	Non-ferrous Metals											E : Round F : Sharp						
	S	Heat Resistant Alloys, Titanium Alloys																	
Work Material	H	Hardened Steels																	
Shape	Order Number	Class	Honing	Coated							Carbide	Dimensions (mm)						Geometry	
				MC5020	MP6120	MP6130	MP7130	MP9120	MP9130	VP15TF	VP20RT	TF15	L	LE	W1	S	BS		RE
General M Breaker 	AOMT123602PEER-M	M	E	●	●	●	●	●	●	●	●		12	10	6.6	3.6	1.8	0.2	
	AOMT123604PEER-M	M	E	●	●	●	●	●	●	●	●		12	10	6.6	3.6	1.6	0.4	
	AOMT123608PEER-M	M	E	●	●	●	●	●	●	●	●		12	10	6.6	3.6	1.2	0.8	
	AOMT123610PEER-M	M	E	●	●	●	●	●	●	●	●		12	10	6.6	3.6	1.0	1.0	
	AOMT123612PEER-M	M	E	●	●	●	●	●	●	●	●		12	10	6.6	3.6	0.8	1.2	
	AOMT123616PEER-M	M	E	●	●	●	●	●	●	●	●		12	10	6.6	3.6	0.4	1.6	
	AOMT123620PEER-M	M	E	●	●	●	●	●	●	●	●		12	10	6.6	3.6	0.4	2.0	
	AOMT123624PEER-M	M	E	●	●	●	●	●	●	●	●		12	10	6.6	3.6	0.4	2.4	
	AOMT123630PEER-M	M	E	●	●	●	●	●	●	●	●		12	10	6.6	3.6	0.4	3.0	
AOMT123632PEER-M	M	E	●	●	●	●	●	●	●	●		12	10	6.6	3.6	0.4	3.2		
Strong Cutting Edge Type H Breaker 	AOMT123604PEER-H	M	E	●	●	●	●	●	●	●	●		12	10	6.6	3.6	1.6	0.4	
	AOMT123608PEER-H	M	E	●	●	●	●	●	●	●	●		12	10	6.6	3.6	1.2	0.8	
	AOMT123616PEER-H	M	E	●	●	●	●	●	●	●	●		12	10	6.6	3.6	0.4	1.6	
For Machining of Aluminium Alloys GM Breaker 	AOGT123602PEFR-GM	G	F								●		12	10	6.6	3.6	1.8	0.2	
	AOGT123604PEFR-GM	G	F								●		12	10	6.6	3.6	1.6	0.4	
	AOGT123608PEFR-GM	G	F									●		12	10	6.6	3.6	1.2	

* Corner radius RE is different from the work material of R shape depending on the axial rake angle of the body.

Note on Use of Inserts with Large Corner Radii

When using inserts with corner radius $RE \geq R2.4\text{mm}$, please machine the holder with a radius form as shown in the table.

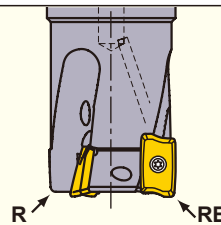

RE (mm)	R (mm)
2.4	1.9
3.0	2.5
3.2	2.7

R : Holder End Radius
RE : Insert Corner Radius

ROTATING TOOLS

RECOMMENDED CUTTING CONDITIONS

CUTTING SPEED

Work Material	Hardness	Insert				ae (mm)			
		Grade Priority		Breaker	≤0.25DC	0.25–0.5DC	0.5–0.75DC	DC (Slot)	
		1st	2nd						
P Mild Steel	≤180HB	MP6120	VP15TF	M H	230(180–270)	220(170–260)	180(140–210)	180(140–210)	
		MP6130	VP20RT	M H	200(150–240)	190(140–230)	150(110–180)	150(110–180)	
Carbon Steel Alloy Steel	180–350HB	MP6120	VP15TF	M H	180(140–210)	170(130–200)	140(110–160)	140(110–160)	
		MP6130	VP20RT	M H	150(110–180)	140(100–170)	110(80–130)	110(80–130)	
M Stainless Steel	≤270HB	MP7130	VP20RT	M H	180(140–210)	170(130–200)	140(110–160)	140(110–160)	
K Gray Cast Iron	≤350MPa	MC5020	VP15TF	H –	250(200–300)	240(190–290)	210(160–260)	140(110–160)	
	≤800MPa	MC5020	VP15TF	H –	130(100–150)	120(90–140)	100(80–120)	100(80–120)	
N Aluminium Alloy	–	TF15	–	GM –	500(200–1000)	500(200–1000)	500(200–1000)	500(200–1000)	
S Titanium Alloy	≤350HB	MP9120	VP15TF	M H	50(40–70)	–	–	50(40–70)	
		MP9130	VP20RT	M H	40(30–60)	–	–	40(30–60)	
Heat-resistant Alloy	–	MP9120	VP15TF	M H	40(30–60)	–	–	40(30–60)	
		MP9130	VP20RT	M H	30(20–40)	–	–	30(20–40)	
H Hardened Steel	40–55HRC	VP15TF	–	H –	90(70–100)	85(60–100)	70(50–80)	70(50–80)	

DEPTH OF CUT AND FEED PER TOOTH

Work Material	Hardness	ae (mm)	DC (mm)					
			ø12–ø16		ø18–ø25		ø28–ø100	
			Depth of Cut ap (mm)	Feed per Tooth fz (mm/t.)	Depth of Cut ap (mm)	Feed per Tooth fz (mm/t.)	Depth of Cut ap (mm)	Feed per Tooth fz (mm/t.)
P Mild Steel Carbon Steel Alloy Steel	≤180HB 180–350HB	≤0.25DC	≤4	0.15	≤5	0.25	≤5	0.20
			4–7	0.10	5–7	0.20	5–7	0.15
			–	–	7–8.5	0.15	7–8.5	0.10
			–	–	8.5–10	0.10	8.5–10	0.07
		0.25–0.5DC	≤2	0.15	≤3	0.25	≤3	0.20
			2–5	0.10	3–5.5	0.20	3–5.5	0.15
			–	–	5.5–8	0.15	5.5–8	0.10
			–	–	8–10	0.10	8–10	0.07
		0.5–0.75DC	≤4	0.10	≤4	0.15	≤3	0.10
			–	–	4–10	0.10	3–7	0.07
		DC (Slot)	≤3	0.10	≤4	0.10	≤3	0.10
			–	–	4–7	0.07	3–5	0.07
M Stainless Steel	≤270HB	≤0.25DC	≤4	0.15	≤5	0.20	≤5	0.20
			4–7	0.10	5–7	0.15	5–7	0.15
			–	–	7–8.5	0.10	7–8.5	0.10
			–	–	8.5–10	0.07	8.5–10	0.07
		0.25–0.5DC	≤2	0.15	≤3	0.20	≤3	0.20
			2–5	0.10	3–5.5	0.15	3–5.5	0.15
			–	–	5.5–8	0.10	5.5–8	0.10
			–	–	8–10	0.07	8–10	0.07
		0.5–0.75DC	≤4	0.10	≤4	0.10	≤3	0.10
			–	–	4–10	0.07	3–7	0.07
		DC (Slot)	≤3	0.10	≤4	0.10	≤3	0.10
			–	–	4–7	0.07	3–5	0.07
K Gray Cast Iron Ductile Cast Iron	Tensile Strength ≤350MPa Tensile Strength ≤800MPa	≤0.25DC	≤4	0.15	≤5	0.25	≤5	0.20
			4–7	0.10	5–7	0.20	5–7	0.15
			–	–	7–8.5	0.15	7–8.5	0.10
			–	–	8.5–10	0.10	8.5–10	0.07
		0.25–0.5DC	≤2	0.15	≤3	0.25	≤3	0.20
			2–5	0.10	3–5.5	0.20	3–5.5	0.15
			–	–	5.5–8	0.15	5.5–8	0.10
			–	–	8–10	0.10	8–10	0.07
		0.5–0.75DC	≤4	0.10	≤4	0.15	≤3	0.10
			–	–	4–10	0.10	3–7	0.07
		DC (Slot)	≤3	0.10	≤4	0.10	≤3	0.10
			–	–	4–7	0.07	3–5	0.07
Ductile Cast Iron	Tensile Strength ≤800MPa	≤0.25DC	≤4	0.10	≤5	0.20	≤5	0.20
			4–7	0.07	5–7	0.15	5–7	0.15
			–	–	7–8.5	0.10	7–8.5	0.10
			–	–	8.5–10	0.07	8.5–10	0.07
		0.25–0.5DC	≤2	0.10	≤3	0.20	≤3	0.20
			2–5	0.07	3–5.5	0.15	3–5.5	0.15
			–	–	5.5–8	0.10	5.5–8	0.10
			–	–	8–10	0.07	8–10	0.07
		0.5–0.75DC	≤4	0.07	≤4	0.10	≤3	0.10
			–	–	4–10	0.07	3–7	0.07
		DC (Slot)	≤3	0.07	≤4	0.10	≤3	0.10
			–	–	4–7	0.07	3–5	0.07

Work Material	Hardness	ae (mm)	DC (mm)					
			ø12-ø16		ø18-ø25		ø28-ø100	
			Depth of Cut ap (mm)	Feed per Tooth fz (mm/t.)	Depth of Cut ap (mm)	Feed per Tooth fz (mm/t.)	Depth of Cut ap (mm)	Feed per Tooth fz (mm/t.)
N Aluminium Alloy	-	≤0.25DC	≤4	0.15	≤4	0.25	≤4	0.20
			4-7	0.10	4-7	0.15	4-7	0.10
		0.25-0.5DC	≤4	0.15	≤4	0.20	≤4	0.20
			4-7	0.10	4-7	0.10	4-7	0.10
S Titanium Alloy	≤350HB	≤0.25DC	≤4	0.15	≤4	0.15	≤4	0.10
			4-7	0.10	4-7	0.10	4-7	0.07
		0.25-0.5DC	≤3	0.05	≤3	0.05	≤3	0.05
			4-7	0.10	4-7	0.05	4-7	0.05
Heat-resistant Alloy	-	0.5-0.75DC	≤2	0.10	≤2	0.05	≤2	0.05
			DC (Slot)	≤1	0.05	≤1	0.05	≤1
H Hardened Steel	40-55HRC	≤0.25DC	≤4	0.10	≤5	0.15	≤5	0.15
			4-7	0.07	5-7	0.10	5-7	0.10
		0.25-0.5DC	-	-	7-8.5	0.07	-	-
			≤2	0.10	≤3	0.15	≤3	0.15
		0.5-0.75DC	2-5	0.07	3-5.5	0.10	-	-
			≤4	0.07	≤4	0.07	≤3	0.07
DC (Slot)	≤3	0.07	≤4	0.07	≤3	0.07		

Note 1) These cutting conditions are a guide to the standard shank type and the arbor type. Please make adjustments according to the machining conditions.
 Note 2) Vibration is liable to occur in certain cases. Please reduce the depth of cut and / or reduce cutting conditions in the following cases.
 • When using the long shank type and extra long shank type.
 • When using long tool overhang with the standard or arbor type.
 • When the application has poor clamping rigidity or when using a low rigidity machine.
 Note 3) In case of coarse and fine pitch cutters, the coarse pitch type is recommended to prevent vibration.
 Note 4) For heavy interrupted and unstable cutting, the H breaker is first recommendation.

RAMPING/HELICAL CUTTING

RAMPING

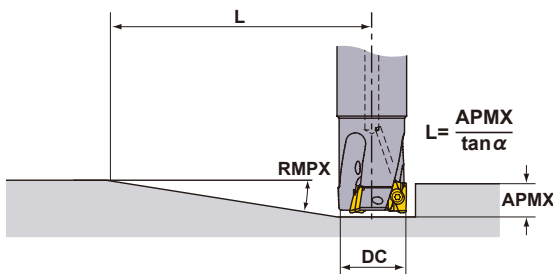

HELICAL CUTTING

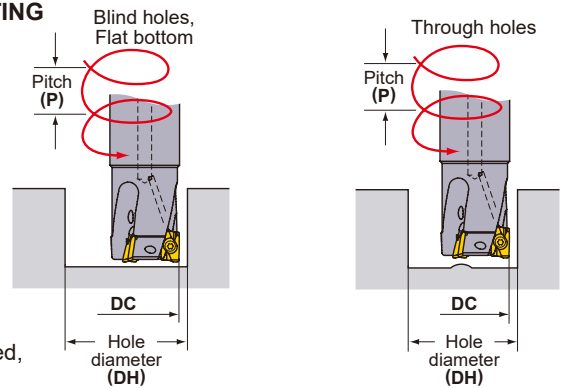

Refer to the table below for cutting conditions. For feed per tooth and cutting speed, follow the cutting conditions for slot milling.

Cutting Edge Diameter DC(mm)	Ramping		Helical Cutting (Blind Hole, Flat Bottom)				Helical Cutting (Through Hole)	
	Maximum Ramping Angle RMPX	Minimum Distance*1 L(mm)	Maximum Hole Diameter*2 DH max.(mm)	Maximum Pitch P max.(mm)	Minimum Hole Diameter DH min.(mm)	Maximum Pitch P max.(mm)	Minimum Hole Diameter DH min.(mm)	Maximum Pitch P max.(mm)
12	6.0°	95	22	2.5	20.5	2	14	0.5
14	6.0°	95	26	2.5	24.5	2	18	1
16	11.3°	50	30	9	28	7	21	2
18	8.6°	66	34	5	32	4.5	25	2
20	6.9°	83	38	5	36	4.5	29	2
22	5.7°	100	42	5	40	4.5	33	2
25	4.6°	124	48	6	46	5	39	3
28	3.8°	151	54	4.5	52	4	45	2
30	3.4°	168	58	4.5	56	4	49	2
32	3.1°	185	62	4.5	60	4	53	2
35	2.7°	212	68	4	66	3.5	59	2
40	2.2°	260	78	4	76	3.5	69	2
50	1.7°	337	98	2	96	2	89	2
63	1.3°	441	124	2	122	2	115	2
80	1.0°	573	158	2	156	2	149	2
100	0.8°	716	198	1	196	1	189	1

Note 1) When machining highly ductile materials with ramping angles above, chips could be continuous. In this case, decrease the ramping angle or feed per tooth.

*1 L (=10 / tan α). Cutters' moving distance until depth of cut reaches 10mm at a maximum ramping angle.

*2 In case corner radius of 0.8mm. Other than that, find with the formula below.

$$\{(\text{cutting edge diameter DC}) - (\text{corner radius}) - 0.2\} \times 2$$

ROTATING TOOLS

MULTI FUNCTIONAL MILLING

90°
KAPR



APX4000



K

ROTATING TOOLS



WELDON SHANK TYPE

KAPR : 90°
With Coolant Hole

Fig.1

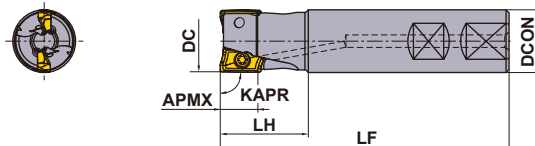
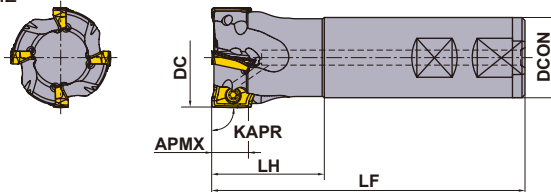

Fig.2



Right hand tool holder only.

DC (mm)	Order Number	Stock R	Number of Teeth	Dimensions(mm)			WT* (kg)	APMX (mm)	RMPX	RPMX (min ⁻¹)	Fig.	Insert Type
				DCON	LF	LH						
25	APX4000R252WA25SA	●	2	25	115	35	0.40	15	11°	18900	1	AO-T18
25	APX4000R252WA25LA	●	2	25	170	35	0.61	15	11°	18900	1	AO-T18
25	APX4000R252WA25ELA	●	2	25	220	80	0.76	15	11°	18900	1	AO-T18
28	APX4000R282WA25LA	●	2	25	170	35	0.63	15	9°	17700	2	AO-T18
28	APX4000R282WA25ELA	●	2	25	220	35	0.81	15	9°	17700	2	AO-T18
32	APX4000R323WA32SA	●	3	32	125	45	0.71	15	7°	16300	1	AO-T18
32	APX4000R323WA32LA	●	3	32	190	45	1.11	15	7°	16300	1	AO-T18
32	APX4000R323WA32ELA	●	3	32	260	100	1.49	15	7°	16300	1	AO-T18
35	APX4000R353WA32LA	●	3	32	190	45	1.14	15	6°	15400	2	AO-T18
40	APX4000R403WA32SA	●	3	32	125	45	0.80	15	6°	14200	2	AO-T18
40	APX4000R404WA32SA	●	4	32	125	45	0.80	15	6°	14200	2	AO-T18
40	APX4000R404WA32LA	●	4	32	190	45	1.19	15	6°	14200	2	AO-T18

Note 1) When using inserts with corner radius RE ≥ 3.2mm, machining of the holder is required as shown on page K144.

Note 2) The maximum allowable spindle speeds (RPMX) are set to ensure tool and insert stability.

Note 3) When using the tool at high spindle speeds, ensure that the tool and arbor are correctly balanced.

* WT : Tool Weight

● : Inventory maintained. ★ : Inventory maintained in Japan.



STRAIGHT SHANK TYPE

KAPR : 90°
With Coolant Hole

Fig.1

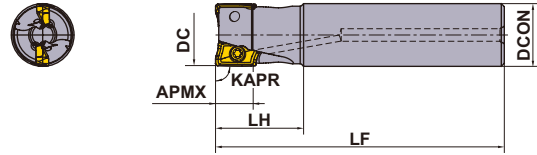
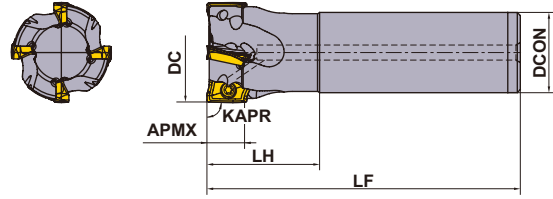

Fig.2



Right hand tool holder only.

DC (mm)	Order Number	Stock R	Number of Teeth	Dimensions(mm)			WT* (kg)	APMX (mm)	RMPX	RPMX (min ⁻¹)	Fig.	Insert Type
				DCON	LF	LH						
25	APX4000R252SA25SA	★	2	25	115	35	0.40	15	11.0°	18900	1	AO-T18
25	APX4000R252SA25LA	★	2	25	170	35	0.61	15	11.0°	18900	1	AO-T18
25	APX4000R252SA25ELA	★	2	25	220	80	0.76	15	11.0°	18900	1	AO-T18
28	APX4000R282SA25LA	★	2	25	170	35	0.63	15	9.0°	17700	2	AO-T18
28	APX4000R282SA25ELA	★	2	25	220	35	0.81	15	9.0°	17700	2	AO-T18
32	APX4000R322SA32SA	★	2	32	125	45	0.71	15	7.0°	16300	1	AO-T18
32	APX4000R323SA32SA	★	3	32	125	45	0.71	15	7.0°	16300	1	AO-T18
32	APX4000R322SA32LA	★	2	32	190	45	1.11	15	7.0°	16300	1	AO-T18
32	APX4000R323SA32LA	★	3	32	190	45	1.11	15	7.0°	16300	1	AO-T18
32	APX4000R322SA32ELA	★	2	32	260	100	1.49	15	7.0°	16300	1	AO-T18
32	APX4000R323SA32ELA	★	3	32	260	100	1.49	15	7.0°	16300	1	AO-T18
35	APX4000R352SA32LA	★	2	32	190	45	1.14	15	6.0°	15400	2	AO-T18
35	APX4000R353SA32LA	★	3	32	190	45	1.14	15	6.0°	15400	2	AO-T18
35	APX4000R352SA32ELA	★	2	32	260	45	1.57	15	6.0°	15400	2	AO-T18
35	APX4000R353SA32ELA	★	3	32	260	45	1.57	15	6.0°	15400	2	AO-T18
40	APX4000R403SA32SA	★	3	32	125	45	0.80	15	6.0°	14200	2	AO-T18
40	APX4000R404SA32SA	★	4	32	125	45	0.80	15	6.0°	14200	2	AO-T18
40	APX4000R402SA32LA	★	2	32	190	45	1.19	15	6.0°	14200	2	AO-T18
40	APX4000R403SA32LA	★	3	32	190	45	1.19	15	6.0°	14200	2	AO-T18
40	APX4000R404SA32LA	★	4	32	190	45	1.19	15	6.0°	14200	2	AO-T18
40	APX4000R402SA32ELA	★	2	32	260	45	1.62	15	6.0°	14200	2	AO-T18
40	APX4000R403SA32ELA	★	3	32	260	45	1.62	15	6.0°	14200	2	AO-T18
40	APX4000R404SA32ELA	★	4	32	260	45	1.62	15	6.0°	14200	2	AO-T18
50	APX4000R504SA32SA	★	4	32	125	45	0.93	15	4.0°	12400	2	AO-T18
50	APX4000R505SA32SA	★	5	32	125	45	0.93	15	4.0°	12400	2	AO-T18
63	APX4000R634SA32SA	★	4	32	125	45	1.15	15	3.0°	10800	2	AO-T18
63	APX4000R636SA32SA	★	6	32	125	45	1.15	15	3.0°	10800	2	AO-T18

Note 1) When using inserts with corner radius RE ≥ 3.2mm, machining of the holder is required as shown on page K144.

Note 2) The maximum allowable spindle speeds (RPMX) are set to ensure tool and insert stability.

Note 3) When using the tool at high spindle speeds, ensure that the tool and arbor are correctly balanced.

* WT : Tool Weight

ROTATING TOOLS

K

ROTATING TOOLS

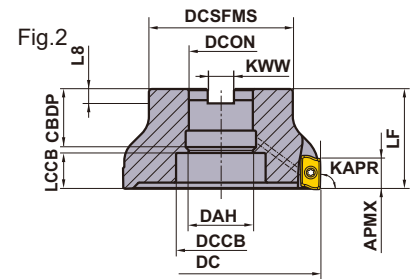
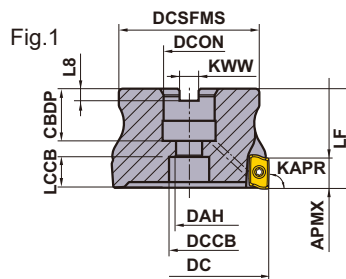

Right hand tool holder only.

ARBOR TYPE

KAPR :90°
GAMP:+15°—+22° GAMF:+21°—+28°
With Coolant Hole

DC (mm)	Set Bolt	Geometry
40	HSC08030H	
50, 63	HSC10030H	
80	HSC12035H	
100	HSC16040H	
125	MBA20040H	
160	MBA24045H	

DC (mm)	Order Number	Stock	Number of Teeth	Dimensions(mm)		WT* (kg)	APMX (mm)	RMPX	RPMX (min ⁻¹)	Fig.	Insert Type
				LF	DCON						
40	APX4000-040A04RA	●	4	40	16	0.2	15	6.0°	14200	1	AO-T18
50	APX4000-050A05RA	●	5	40	22	0.3	15	4.0°	12400	1	AO-T18
63	APX4000-063A06RA	●	6	40	22	0.5	15	3.0°	10800	1	AO-T18
80	APX4000-080A07RA	●	7	50	27	1.2	15	2.0°	9300	1	AO-T18
100	APX4000-100A08RA	●	8	50	32	2.1	15	1.5°	8100	1	AO-T18
125	APX4000-125A09RA	●	9	63	40	3.3	15	1.0°	7100	2	AO-T18
160	APX4000-160A10RA	●	10	63	40	4.8	15	1.0°	6100	2	AO-T18

Note 1) When using inserts with corner radius RE ≥ 3.2mm, machining of the holder is required as shown on page K144.

Note 2) The maximum allowable spindle speeds (RPMX) are set to ensure tool and insert stability.

Note 3) When using the tool at high spindle speeds, ensure that the tool and arbor are correctly balanced.

* WT : Tool Weight

MOUNTING DIMENSIONS

DC (mm)	Order Number	Dimensions(mm)							
		DCON	CBDP	DAH	DCCB	LCCB	DCSFMS	KWW	L8
40	APX4000-040A04RA	16	18	9	14	10.08	34	8.4	5.6
50	APX4000-050A05RA	22	20	11	17	12.26	45	10.4	6.3
63	APX4000-063A06RA	22	20	11	17	12.35	50	10.4	6.3
80	APX4000-080A07RA	27	23	13	20	15.35	60	12.4	7
100	APX4000-100A08RA	32	26	17	27	17.35	70	14.4	8
125	APX4000-125A09RA	40	40	42	56	22.35	90	16.4	9
160	APX4000-160A10RA	40	40	42	72	22.35	100	16.4	9

● : Inventory maintained. ★ : Inventory maintained in Japan.

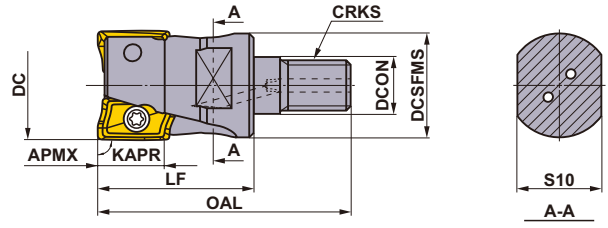

Right hand tool holder only.

SCREW-IN TYPE

With Coolant Hole



DC (mm)	Order Number	Stock R	Number of Teeth	Dimensions(mm)							WT* (kg)	APMX (mm)	RMPX	Insert Type
				DCON	DCSFMS	OAL	LF	S10	CRKS					
25	APX4000R252M12A35	●	2	12.5	23.5	57	35	19	M12	0.2	15	11.0°	AO-T18	
28	APX4000R282M12A35	●	2	12.5	23.5	57	35	19	M12	0.2	15	9.0°	AO-T18	
32	APX4000R322M16A40	★	2	17	28.5	63	40	24	M16	0.3	15	7.0°	AO-T18	
32	APX4000R323M16A40	●	3	17	28.5	63	40	24	M16	0.3	15	7.0°	AO-T18	
35	APX4000R352M16A40	★	2	17	28.5	63	40	24	M16	0.3	15	6.0°	AO-T18	
35	APX4000R353M16A40	★	3	17	28.5	63	40	24	M16	0.3	15	6.0°	AO-T18	
40	APX4000R403M16A40	★	3	17	28.5	63	40	24	M16	0.3	15	6.0°	AO-T18	
40	APX4000R404M16A40	●	4	17	28.5	63	40	24	M16	0.3	15	6.0°	AO-T18	

Note 1) When using inserts with corner radius $RE \geq 3.2\text{mm}$, machining of the holder is required as shown on page K144.

Note 2) For screw-in type arbors, refer to page K244.

* WT : Tool Weight

SPARE PARTS

DC (mm)	Tool Holder Type	DC (mm)	Tool Holder Type			
				Clamp Screw	Wrench	Anti-seize Lubricant
25	APX4000R25	28	APX4000R28	TPS4	TIP15W	MK1KS
32	APX4000R32	35	APX4000R35	TPS4	TIP15W	MK1KS
40	APX4000R40	40	APX4000-040	TPS43	TIP15W	MK1KS
50	APX4000R50	50	APX4000-050	TPS43	TIP15W	MK1KS
63	APX4000R63	63	APX4000-063	TPS43	TIP15W	MK1KS
		80	APX4000-080	TPS43	TIP15W	MK1KS
		100	APX4000-100	TPS43	TIP15W	MK1KS
		125	APX4000-125	TPS43	TIP15W	MK1KS
		160	APX4000-160	TPS43	TIP15W	MK1KS

* Clamp Torque (N · m) : TPS4 = 4.0, TPS43 = 4.0

K

ROTATING TOOLS

ROTATING TOOLS

INSERTS

Work Material	P	Steels	●		●		●		●		●		Cutting Conditions (Guide) : ● : Stable Cutting ● : General Cutting ✖ : Unstable Cutting						
	M	Stainless Steels	●		●		●		●		●								
Work Material	K	Cast Irons	●		●		●		●		●		Honing : E : Round						
	S	Heat Resistant Alloys, Titanium Alloys	●		●		●		●		●								
	H	Hardened Steels	●		●		●		●		●								
Shape	Order Number	Class	Honing	Coated							Dimensions (mm)						Geometry		
				MC5020	MP6120	MP6130	MP7130	MP9120	MP9130	VP15TF	VP20RT	L	LE	W1	S	BS		RE	*
General M Breaker	AOMT184804PEER-M	M	E	●	●	●	●	●	●	●	●	●	18	15	9	4.8	1.8	0.4	
	AOMT184808PEER-M	M	E	●	●	●	●	●	●	●	●	●	18	15	9	4.8	1.4	0.8	
	AOMT184810PEER-M	M	E	●	●	●	●	●	●	●	●	●	18	15	9	4.8	1.0	1.0	
	AOMT184812PEER-M	M	E	●	●	●	●	●	●	●	●	●	18	15	9	4.8	0.8	1.2	
	AOMT184816PEER-M	M	E	●	●	●	●	●	●	●	●	●	18	15	9	4.8	0.4	1.6	
	AOMT184820PEER-M	M	E	●	●	●	●	●	●	●	●	●	18	15	9	4.8	0.4	2.0	
Strong Cutting Edge Type H Breaker	AOMT184804PEER-H	M	E	●	●	●	●	●	●	●	●	●	18	15	9	4.8	1.8	0.4	
	AOMT184808PEER-H	M	E	●	●	●	●	●	●	●	●	●	18	15	9	4.8	1.4	0.8	
	AOMT184816PEER-H	M	E	●	●	●	●	●	●	●	●	●	18	15	9	4.8	0.4	1.6	
	AOMT184832PEER-H	M	E	●	●	●	●	●	●	●	●	●	18	15	9	4.8	0.4	3.2	
	AOMT184840PEER-H	M	E	●	●	●	●	●	●	●	●	●	18	15	9	4.8	0.4	4.0	
	AOMT184850PEER-H	M	E	●	●	●	●	●	●	●	●	●	18	15	9	4.8	-	5.0	
AOMT184864PEER-H	M	E	●	●	●	●	●	●	●	●	●	18	15	9	4.8	-	6.35		

* Corner radius RE is different from the work material of R shape depending on the axial rake angle of the body.

Note on Use of Inserts with Large Corner Radii

When using inserts with corner radius $RE \geq R3.2\text{mm}$, please machine the holder with a radius form as shown in the table.

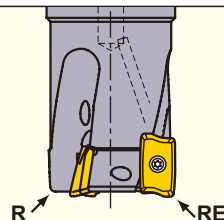

RE (mm)	R (mm)
3.2	2.0
4.0	2.5
5.0	3.5
6.35	5.0

R : Holder End Radius
RE : Insert Corner Radius

RECOMMENDED CUTTING CONDITIONS

CUTTING SPEED

Work Material	Hardness	Insert				ae (mm)			
		Grade Priority		Breaker	≤0.25DC	0.25–0.5DC	0.5–0.75DC	DC (Slot)	
		1st	2nd						Cutting Speed Vc (m/min)
P Mild Steel	≤180HB	MP6120	VP15TF	M H	230(180–270)	220(170–260)	180(140–210)	180(140–210)	
		MP6130	VP20RT	M H	200(150–240)	190(140–230)	150(110–180)	150(110–180)	
Carbon Steel Alloy Steel	180–350HB	MP6120	VP15TF	M H	180(140–210)	170(130–200)	140(110–160)	140(110–160)	
		MP6130	VP20RT	M H	150(110–180)	140(100–170)	110(80–130)	110(80–130)	
M Stainless Steel	≤270HB	MP7130	VP20RT	M H	180(140–210)	170(130–200)	140(110–160)	140(110–160)	
K Gray Cast Iron	≤350MPa	MC5020	VP15TF	H –	250(200–300)	240(190–290)	210(160–260)	140(110–160)	
	≤800MPa	MC5020	VP15TF	H –	130(100–150)	120(90–140)	100(80–120)	100(80–120)	
S Titanium Alloy	≤350HB	MP9120	VP15TF	H M	50(40–70)	–	–	50(40–70)	
		MP9130	VP20RT	H M	40(30–60)	–	–	40(30–60)	
	Heat-resistant Alloy	MP9120	VP15TF	H M	40(30–60)	–	–	40(30–60)	
		MP9130	VP20RT	H M	30(20–40)	–	–	30(20–40)	
H Hardened Steel	40–55HRC	VP15TF	–	H –	90(70–100)	85(60–100)	70(50–80)	70(50–80)	

K

ROTATING TOOLS

DEPTH OF CUT AND FEED PER TOOTH

Work Material	Hardness	ae (mm)	Depth of Cut ap (mm)	Feed per Tooth fz (mm/t.)		
				Cutter Diameter DC (mm)		
				ø25–ø40	ø50–ø80	ø100–ø160
P Mild Steel Carbon Steel Alloy Steel	≤180HB	≤0.5DC	≤5	0.30	0.30	0.25
			5–7.5	0.25	0.25	0.20
			7.5–10	0.20	0.20	0.15
			10–12.5	0.15	0.15	0.10
			12.5–15	0.10	0.10	0.07
		0.5–0.75DC	≤5	0.20	0.20	0.15
	180–350HB	0.5–0.75DC	5–10	0.15	0.15	0.10
			10–15	0.10	0.10	0.07
			DC (Slot)	≤5	0.15	0.15
		5–7.5	0.10	0.10	0.10	
		7.5–10	0.07	0.07	0.07	
		M Stainless Steel	≤270HB	≤0.5DC	≤5	0.30
5–7.5	0.25				0.20	0.20
7.5–10	0.20				0.15	0.15
10–12.5	0.15				0.10	0.10
12.5–15	0.10				0.07	0.07
0.5–0.75DC	≤5			0.20	0.15	0.15
180–350HB	0.5–0.75DC		5–10	0.15	0.10	0.10
			10–15	0.10	0.07	0.07
			DC (Slot)	≤5	0.15	0.15
	5–7.5		0.10	0.10	0.10	
	7.5–10		0.07	0.07	0.07	
	K Gray Cast Iron Ductile Cast Iron		Tensile Strength ≤350MPa	≤0.5DC	≤5	0.30
5–7.5		0.25			0.25	0.20
7.5–10		0.20			0.20	0.15
10–12.5		0.15			0.15	0.10
12.5–15		0.10			0.10	0.07
0.5–0.75DC		≤5		0.20	0.20	0.15
		5–10		0.15	0.15	0.10
		10–15		0.10	0.10	0.07
		DC (Slot)		≤5	0.15	0.15
≤800MPa		≤0.5DC	≤5	0.25	0.25	0.25
			5–7.5	0.20	0.20	0.20
			7.5–10	0.15	0.15	0.15
			10–12.5	0.10	0.10	0.10
			12.5–15	0.07	0.07	0.07
		0.5–0.75DC	≤5	0.20	0.20	0.15
			5–10	0.15	0.15	0.10
			10–15	0.10	0.10	0.07
			DC (Slot)	≤5	0.15	0.15
5–7.5	0.10	0.10	0.10			
7.5–10	0.07	0.07	0.07			

RECOMMENDED CUTTING CONDITIONS

DEPTH OF CUT AND FEED PER TOOTH

Work Material	Hardness	ae (mm)	Depth of Cut ap (mm)	Feed per Tooth fz (mm/t.)		
				Cutter Diameter DC (mm)		
				ø25-ø40	ø50-ø80	ø100-ø160
S Titanium Alloy	≤350HB	≤0.25DC	≤5	0.15	0.10	0.10
			5-7.5	0.10	0.05	0.05
			7.5-10	0.05	-	-
		DC (Slot)	≤5	0.05	0.05	0.05
Heat-resistant Alloy	-	≤0.25DC	≤2	0.10	0.05	0.05
		DC (Slot)	≤1	0.05	0.05	0.05
H Hardened Steel	40-55HRC	≤0.25DC	≤5	0.15	0.15	0.15
			5-7.5	0.10	0.10	0.10
			7.5-10	0.07	0.07	0.07
		0.25-0.5DC	≤5	0.10	0.10	0.10
			5-7.5	0.07	0.07	0.07
		0.5-0.75DC	≤5	0.07	0.07	0.07
			DC (Slot)	≤5	0.07	0.07

Note 1) These cutting conditions are a guide to the standard shank type and the arbor type.

Please make adjustments according to the machining conditions.

Note 2) Vibration is liable to occur in certain cases. Please reduce the depth of cut and / or reduce cutting conditions in the following cases.

- When using the long shank type and extra long shank type.
- When using long tool overhang with the standard or arbor type.
- When the application has poor clamping rigidity or when using a low rigidity machine.

Note 3) In case of coarse and fine pitch cutters, the coarse pitch type is recommended to prevent vibration.

Note 4) For heavy interrupted and unstable cutting, the H breaker is first recommendation.

RAMPING/HELICAL CUTTING

RAMPING

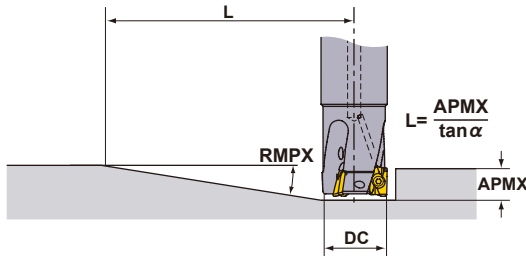

HELICAL CUTTING

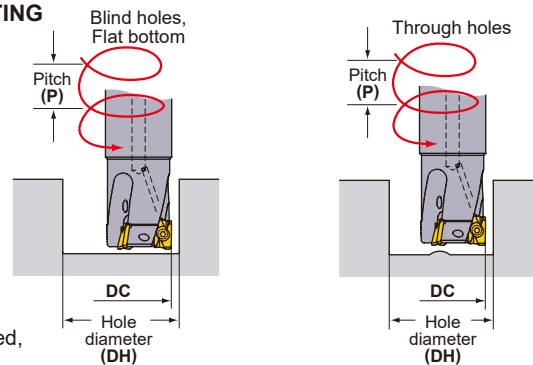

Refer to the table below for cutting conditions. For feed per tooth and cutting speed, follow the cutting conditions for slot milling.

Cutting Edge Diameter DC (mm)	Ramping		Helical Cutting (Blind Hole, Flat Bottom)				Helical Cutting (Through Hole)	
	Maximum Ramping Angle RMPX	Minimum Distance *1 L (mm)	Maximum Hole Diameter *2 DH max. (mm)	Maximum Pitch P max. (mm)	Minimum Hole Diameter DH min. (mm)	Maximum Pitch P max. (mm)	Minimum Hole Diameter DH min. (mm)	Maximum Pitch P max. (mm)
25	11°	85	48	14	45	12	32	4
28	9°	105	54	12	51	11	38	4
32	7°	135	62	11	59	10	46	5
35	6°	158	68	10	65	9	52	5
40	6°	158	78	12	75	11	62	7
50	4°	238	98	10	95	9	82	7
63	3°	318	124	10	121	9	108	7
80	2°	477	158	8	155	8	142	6
100	1.5°	636	198	8	195	7	182	6
125	1°	954	248	6	245	6	232	5
160	1°	954	318	8	315	8	302	7

Note 1) When machining highly ductile materials with ramping angles above, chips could be continuous.

In this case, decrease the ramping angle or feed per tooth.

*1 $L = 15 / \tan(\alpha)$. Cutters' moving distance until depth of cut reaches 15mm at a maximum ramping angle.

*2 In case corner radius of 0.8mm. Other than that, calculate using the formula below.

$$\{(\text{cutting edge diameter DC}) - (\text{corner radius}) - 0.2\} \times 2$$

DEEP SHOULDER MILLING

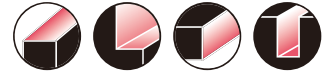

APX3000

LONG CUTTING EDGE

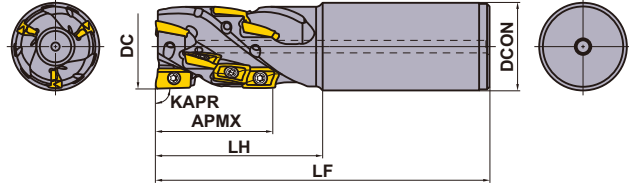
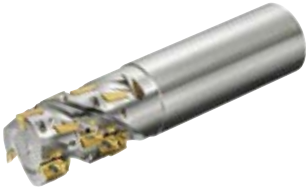

Right hand tool holder only.

K

ROTATING TOOLS

SHANK TYPE

DC (mm)	Order Number	Stock R	Coolant Hole	Number of Flutes	Total	Dimensions(mm)			WT* (kg)	APMX (mm)	Insert Type
						DCON	LF	LH			
20	APX3KR2004SN20S028A	★	—	1	4	20	125	45	0.27	28	AO-T12
25	APX3KR2506SA25S028A	●	○	2	6	25	125	45	0.40	28	AO-T12
25	APX3KR2508SA25M037A	●	○	2	8	25	130	50	0.41	37	AO-T12
32	APX3KR3208SA32S037A	★	○	2	8	32	130	50	0.70	37	AO-T12
32	APX3KR3210SA32M046A	★	○	2	10	32	140	60	0.74	46	AO-T12
32	APX3KR3212SA32S037A	★	○	3	12	32	130	50	0.67	37	AO-T12
32	APX3KR3215SA32M046A	★	○	3	15	32	140	60	0.71	46	AO-T12
40	APX3KR4015SA42S046A	★	○	3	15	42	140	60	1.24	46	AO-T12
40	APX3KR4018SA42M055A	★	○	3	18	42	150	70	1.31	55	AO-T12

Note 1) When using inserts with corner radius $RE \geq 2.4\text{mm}$, machining of the holder is required as shown on page K149.

Note 2) Corner radius $RE 0.8\text{mm}$ is recommended for the peripheral cutting edges except the bottom cutting edge (end cutting).

Inserts $RE 0.2\text{mm}$ and 0.4mm can also be used.

* WT : Tool Weight

SPARE PARTS

DC (mm)	Tool Holder Type	*		
		Clamp Screw	Wrench	Anti-seize Lubricant
20	APX3KR20	TPS25	TIP07F	MK1KS
25	APX3KR25	TPS25-1	TIP07F	MK1KS
32	APX3KR32	TPS25-1	TIP07F	MK1KS
40	APX3KR40	TPS25-1	TIP07F	MK1KS
40	APX3K-040	TPS25-1	TIP07F	MK1KS
50	APX3K-050	TPS25-1	TIP07F	MK1KS

* Clamp Torque (N · m) : TPS25 = 1.0, TPS25-1 = 1.0

● : Inventory maintained. ★ : Inventory maintained in Japan.

SPARE PARTS > N001
TECHNICAL DATA > P001

ROTATING TOOLS

ROTATING TOOLS

K

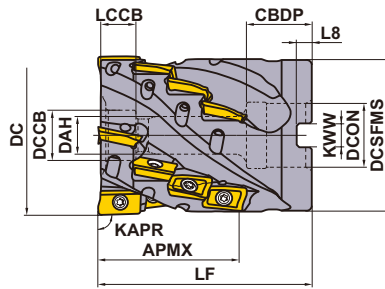

Right hand tool holder only.

DC (mm)	Set Bolt	Geometry
40	HSC08040	
50	HSC10045	

■ SHELL TYPE

With Coolant Hole

KAPR : 90°
GAMP : +12° GAMF : +6°

DC (mm)	Order Number	Stock R	Number of Flutes	Total	Dimensions(mm)		WT* (kg)	APMX (mm)	 Insert Type
					LF	DCON			
40	APX3K-040A16A037RA	★	4	16	50	16	0.25	37	AO-T12
50	APX3K-050A20A046RA	★	4	20	60	22	0.54	46	AO-T12

Note 1) When using inserts with corner radius $RE \geq 2.4\text{mm}$, machining of the holder is required as shown on page K149.

Note 2) Corner radius RE 0.8mm is recommended for the peripheral cutting edges except the bottom cutting edge (end cutting).

Inserts RE 0.2mm and 0.4mm can also be used.

Note 3) Coolant can be supplied from the end face of the centering location bore in the arbor. However, it cannot be supplied from the set bolt.

* WT : Tool Weight

MOUNTING DIMENSIONS

DC (mm)	Order Number	Dimensions(mm)							
		DCON	CBDP	DAH	DCCB	LCCB	DCSFMS	KWW	L8
40	APX3K-040A16A037RA	16	18	9	14	9.9	38.5	8.4	5.6
50	APX3K-050A20A046RA	22	20	11	17	11.9	48.4	10.4	6.3

● : Inventory maintained. ★ : Inventory maintained in Japan.

(10 inserts in one case)

INSERTS

Work Material	P	Steels											Cutting Conditions (Guide) :							
	M	Stainless Steels											● : Stable Cutting ● : General Cutting ⊕ : Unstable Cutting							
Work Material	K	Cast Irons											Honing :							
	N	Non-ferrous Metals											E : Round F : Sharp							
	S	Heat Resistant Alloys, Titanium Alloys																		
Work Material	H	Hardened Steels																		
Shape	Order Number	Class	Honing	Coated							Carbide	Dimensions (mm)						Geometry		
				MC5020	MP6120	MP6130	MP7130	MP9120	MP9130	VP15TF	VP20RT	TF15	L	LE	W1	S	BS		RE	*
General M Breaker	AOMT123602PEER-M	M	E	●	●	●	●	●	●	●	●			12	10	6.6	3.6	1.8	0.2	
	AOMT123604PEER-M	M	E	●	●	●	●	●	●	●	●			12	10	6.6	3.6	1.6	0.4	
	AOMT123608PEER-M	M	E	●	●	●	●	●	●	●	●			12	10	6.6	3.6	1.2	0.8	
	AOMT123610PEER-M	M	E	●	●	●	●	●	●	●	●			12	10	6.6	3.6	1.0	1.0	
	AOMT123612PEER-M	M	E	●	●	●	●	●	●	●	●			12	10	6.6	3.6	0.8	1.2	
	AOMT123616PEER-M	M	E	●	●	●	●	●	●	●	●			12	10	6.6	3.6	0.4	1.6	
	AOMT123620PEER-M	M	E	●	●	●	●	●	●	●	●			12	10	6.6	3.6	0.4	2.0	
	AOMT123624PEER-M	M	E	●	●	●	●	●	●	●	●			12	10	6.6	3.6	0.4	2.4	
	AOMT123630PEER-M	M	E	●	●	●	●	●	●	●	●			12	10	6.6	3.6	0.4	3.0	
AOMT123632PEER-M	M	E	●	●	●	●	●	●	●	●			12	10	6.6	3.6	0.4	3.2		
Strong Cutting Edge Type H Breaker	AOMT123604PEER-H	M	E	●	●	●	●	●	●	●	●			12	10	6.6	3.6	1.6	0.4	
	AOMT123608PEER-H	M	E	●	●	●	●	●	●	●	●			12	10	6.6	3.6	1.2	0.8	
	AOMT123616PEER-H	M	E	●	●	●	●	●	●	●	●			12	10	6.6	3.6	0.4	1.6	
For Machining of Aluminium Alloys GM Breaker	AOGT123602PEFR-GM	G	F									●		12	10	6.6	3.6	1.8	0.2	
	AOGT123604PEFR-GM	G	F									●		12	10	6.6	3.6	1.6	0.4	
	AOGT123608PEFR-GM	G	F									●		12	10	6.6	3.6	1.2	0.8	

* Corner radius RE is different from the work material of R shape depending on the axial rake angle of the body.

Note on Use of Inserts with Large Corner Radii

When using inserts with corner radius $RE \geq R2.4\text{mm}$, please machine the holder with a radius form as shown in the table.

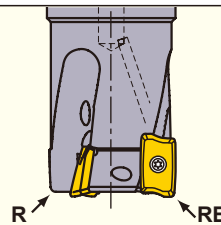

RE (mm)	R (mm)
2.4	1.9
3.0	2.5
3.2	2.7

R : Holder End Radius
RE : Insert Corner Radius

K

ROTATING TOOLS

ROTATING TOOLS

RECOMMENDED CUTTING CONDITIONS

CUTTING SPEED

Work Material	Insert			ae (mm)			
	Grade Priority		Breaker	≤0.25DC	0.25–0.75DC	DC (Slot)	
	1st	2nd					
P Mild Steel	MP6120	VP15TF	M H	180(140–220)	150(110–180)	120(100–140)	
	MP6130	VP20RT	M H	160(120–200)	130(100–160)	100(80–120)	
	Carbon Steel Alloy Steel, Alloy Tool Steel	MP6120	VP15TF	M H	150(100–200)	120(90–150)	100(80–120)
		MP6130	VP20RT	M H	130(90–170)	90(70–110)	80(60–100)
	Pre-hardened Steel	MP6120	VP15TF	M H	120(80–160)	100(70–130)	90(50–120)
MP6130		VP20RT	M H	100(70–130)	90(60–120)	70(50–100)	
M Stainless Steel	MP7130	—	M —	150(120–180)	120(100–140)	100(80–120)	
K Gray Cast Iron	MC5020	—	H —	200(150–250)	180(150–210)	—	
	VP15TF	—	M H	180(120–240)	150(100–200)	100(60–140)	
	VP15TF	—	M H	160(120–200)	140(100–180)	80(60–100)	
Ductile Cast Iron	VP15TF	—	M H	160(120–200)	140(100–180)	80(60–100)	
N Aluminium Alloy	TF15	MP9120	GM M	400(200–800)	400(200–800)	400(200–800)	
S Titanium Alloy	MP9130	—	M —	40(30–60)	—	40(30–60)	
	MP9120	—	M —	50(40–70)	—	50(40–70)	
	Heat Resistant Alloy	MP9120	VP15TF	M H	40(30–60)	—	40(30–60)
		MP9130	VP20RT	M H	30(20–40)	—	30(20–40)

DEPTH OF CUT / FEED PER TOOTH

Work Material	Characteristics	ae	DC (mm)						
			ø20		ø25		ø32–ø50		
			ap	fz (mm/t.)	ap	fz (mm/t.)	ap	fz (mm/t.)	
P Mild Steel	≤180HB	≤0.25DC	≤28	0.15	≤37	0.17	≤55	0.2	
		0.25-0.75DC	≤28	0.12	≤37	0.15	≤55	0.17	
		DC (Slot)	≤18	0.08	≤18	0.08	≤18	0.08	
	Carbon Steel Alloy Steel	180–280HB	≤0.25DC	≤28	0.12	≤37	0.15	≤55	0.17
			0.25-0.75DC	≤28	0.1	≤37	0.12	≤55	0.15
			DC (Slot)	≤18	0.08	≤18	0.08	≤18	0.08
	Tool Alloy Steel	≤350HB (Annealing)	≤0.25DC	≤28	0.12	≤37	0.15	≤55	0.17
			0.25-0.75DC	≤28	0.1	≤37	0.12	≤55	0.15
			DC (Slot)	≤18	0.08	≤18	0.08	≤18	0.08
Pre-hardened Steel	35–45HRC	≤0.25DC	≤28	0.12	≤37	0.15	≤55	0.17	
		0.25-0.75DC	≤28	0.1	≤37	0.12	≤55	0.15	
		DC (Slot)	≤18	0.08	≤18	0.08	≤18	0.08	
M Ferritic and Martensitic Stainless Steel	—	≤0.25DC	≤28	0.12	≤37	0.15	≤55	0.17	
		0.25-0.75DC	≤28	0.1	≤37	0.12	≤55	0.15	
		DC (Slot)	≤18	0.08	≤18	0.08	≤18	0.08	
	Duplex Stainless Steel	≤280HB	≤0.25DC	≤28	0.12	≤37	0.15	≤55	0.17
			0.25-0.75DC	≤28	0.1	≤37	0.12	≤55	0.15
			DC (Slot)	≤18	0.08	≤18	0.08	≤18	0.08
Precipitation Hardening Stainless Steel	<450HB	≤0.25DC	≤28	0.12	≤37	0.15	≤55	0.17	
		0.25-0.75DC	≤28	0.1	≤37	0.12	≤55	0.15	
		DC (Slot)	≤18	0.08	≤18	0.08	≤18	0.08	
K Gray Cast Iron	Tensile Strength ≤350MPa	≤0.25DC	≤28	0.15	≤37	0.17	≤55	0.2	
		0.25-0.75DC	≤28	0.12	≤37	0.15	≤55	0.17	
		DC (Slot)	≤18	0.1	≤18	0.1	≤18	0.1	
Ductile Cast Iron	Tensile Strength ≤800MPa	≤0.25DC	≤28	0.12	≤37	0.15	≤55	0.17	
		0.25-0.75DC	≤28	0.1	≤37	0.12	≤55	0.15	
		DC (Slot)	≤18	0.08	≤18	0.08	≤18	0.08	
N Aluminium Alloy	—	≤0.25DC	≤28	0.15	≤37	0.17	≤55	0.2	
		0.25-0.75DC	—	—	≤9	0.17	≤9	0.2	
		DC (Slot)	—	—	≤9	0.17	≤9	0.2	
S Titanium Alloy	≤350HB	≤0.25DC	≤28	0.1	≤37	0.1	≤55	0.1	
		0.25-0.75DC	—	—	—	—	—	—	
		DC (Slot)	≤18	0.06	≤18	0.06	≤18	0.06	
	Heat Resistant Alloy	—	≤0.25DC	≤28	0.08	≤37	0.08	≤55	0.08
0.25-0.75DC			—	—	—	—	—	—	
DC (Slot)	≤18	0.05	≤18	0.05	≤18	0.05			

Note 1) The above cutting conditions are determined based on high rigidity machine and work materials, where no vibration occurred. Please adjust processing conditions if the vibration is generated.

DEEP SHOULDER MILLING

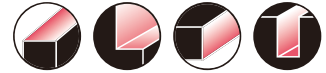

APX4000

LONG CUTTING EDGE

- P
M
K
N
S
H



Fig.1

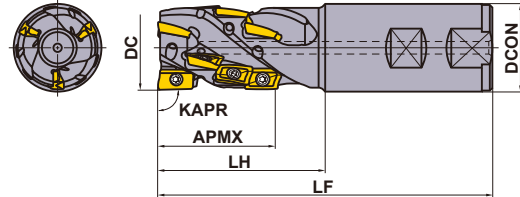
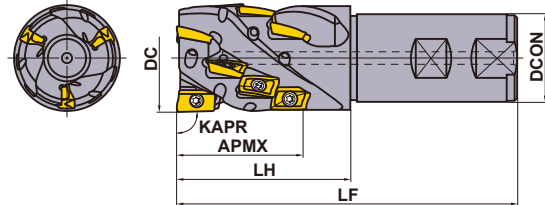

Fig.2



Right hand tool holder only.

SHANK TYPE

KAPR : 90°
With Coolant Hole



DC (mm)	Order Number	Stock R	Number of Flutes	Total	Dimensions(mm)			WT* (kg)	APMX (mm)	Fig.	Insert Type
					DCON	LF	LH				
40	APX4KR4008WA40S056A	●	2	8	40	150	80	1.54	56	1	AO-T18
40	APX4KR4012WA40S056A	●	3	12	40	150	80	1.54	56	1	AO-T18
50	APX4KR5012WA40S056A	●	3	12	40	150	80	1.76	56	2	AO-T18
50	APX4KR5018WA40M084A	●	3	18	40	180	110	2.18	84	2	AO-T18

Note 1) When using inserts with corner radius $RE \geq 3.2\text{mm}$, machining of the holder is required as shown on page K153.

Note 2) Only corner radius RE 0.4mm and 0.8mm can be used for the peripheral cutting edges except the bottom cutting edge (the end cutting edge).

* WT : Tool Weight

SPARE PARTS

		
Clamp Screw	Wrench	Anti-seize Lubricant
TPS43	TIP15W	MK1KS

* Clamp Torque (N · m) : TPS43 = 4.0

● : Inventory maintained.

SPARE PARTS > N001
TECHNICAL DATA > P001

ROTATING TOOLS

K

ROTATING TOOLS

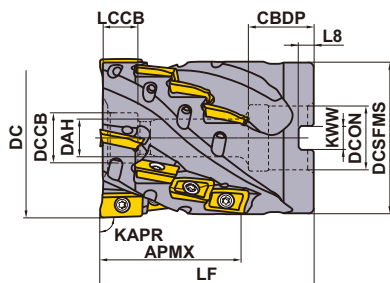

Right hand tool holder only.

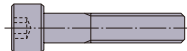
DC (mm)	Set Bolt	Geometry
50	HSC10050	
63	HSC12070	

■ SHELL TYPE

With Coolant Hole

KAPR :90°
GAMP:+12° GAMF:+6°

DC (mm)	Order Number	Stock	Number of Flutes	Total	Dimensions(mm)		WT* (kg)	APMX (mm)	 Insert Type
					LF	DCON			
50	APX4K-050A09A042RA	●	3	9	65	22	0.75	42	AO-T18
63	APX4K-063A16A056RA	●	4	16	85	27	1.63	56	AO-T18

Note 1) When using inserts with corner radius $RE \geq 3.2\text{mm}$, machining of the holder is required as shown on page K153.

Note 2) Only corner radius RE 0.4mm and 0.8mm can be used for the peripheral cutting edges except the bottom cutting edge (the end cutting edge).

Note 3) Coolant can be supplied from the end face of the centering location bore in the arbor. However, it cannot be supplied from the set bolt.

* WT : Tool Weight

MOUNTING DIMENSIONS

DC (mm)	Order Number	Dimensions(mm)							
		DCON	CBDP	DAH	DCCB	LCCB	DCSFMS	KWW	L8
50	APX4K-050A09A042RA	22	22	11	17	12.5	48	10.4	6.3
63	APX4K-063A16A056RA	27	28	13	20	14	60.7	12.4	7

● : Inventory maintained.
(10 inserts in one case)

ROTATING TOOLS

RECOMMENDED CUTTING CONDITIONS

CUTTING SPEED

Work Material	Hardness	Insert				Cutting Width a_e (mm)		
		Grade		Breaker		$\leq 0.15DC$	0.15–0.3DC	DC (Slot)
		1st Recommendation	2nd Recommendation					
Cutting Speed V_c (m/min)								
P Mild Steel	$\leq 180HB$	MP6120	VP15TF	M	H	200(160–250)	160(120–200)	140(120–160)
		MP6130	VP20RT	M	H	170(130–220)	130(90–170)	110(90–130)
Carbon Steel Alloy Steel	180–350HB	MP6120	VP15TF	M	H	160(120–200)	120(100–140)	100(80–120)
		MP6130	VP20RT	M	H	130(90–170)	90(70–110)	70(50–90)
M Stainless Steel	$\leq 270HB$	MP7130	VP15TF	M	H	160(120–200)	120(100–140)	100(80–120)
K Gray Cast Iron	$\leq 350MPa$	MC5020	VP15TF	H	–	230(180–280)	190(140–240)	190(140–240)
Ductile Cast Iron	$\leq 800MPa$	MC5020	VP15TF	H	–	190(140–220)	170(120–220)	170(120–220)
S Titanium Alloy	$\leq 350HB$	MP9120	VP15TF	H	M	50(40–70)	–	50(40–70)
		MP9130	VP20RT	H	M	40(30–60)	–	40(30–60)
Heat-resistant Alloy	–	MP9120	VP15TF	H	M	40(30–60)	–	40(30–60)
		MP9130	VP20RT	H	M	30(20–40)	–	30(20–40)

DEPTH OF CUT AND FEED PER TOOTH

Work Material	Characteristics	Cutting Width a_e (mm)	Depth of Cut a_p (mm)	Feed per Tooth f_z (mm/t.)		
				Cutter Diameter DC (mm)		
				$\phi 40$ Length of cut 56mm $\phi 50$ Length of cut 42mm	$\phi 50$ Length of cut 56mm $\phi 63$ Length of cut 56mm	$\phi 50$ Length of cut 84mm
P Mild Steel	$\leq 180HB$	$\leq 0.3DC$	≤ 20	0.25	0.25	0.20
			20–50	0.20	0.20	0.15
			50–80	–	–	0.10
		DC (Slot)	≤ 20	0.20	0.20	0.15
20–50	0.15		0.15	–		
50–80	–		–	–		
Carbon Steel Alloy Steel	180–350HB	$\leq 0.3DC$	≤ 20	0.25	0.25	0.20
			20–50	0.20	0.20	0.15
			50–80	–	–	0.10
		DC (Slot)	≤ 20	0.15	0.15	0.10
20–50	0.10		0.10	–		
50–80	–		–	–		
M Stainless Steel	$\leq 270HB$	$\leq 0.3DC$	≤ 20	0.25	0.25	0.20
			20–50	0.20	0.20	0.15
			50–80	–	–	0.10
		DC (Slot)	≤ 10	0.10	0.10	0.07
K Gray Cast Iron	Tensile Strength $\leq 350MPa$	$\leq 0.15DC$	≤ 10	0.30	0.30	0.25
			10–50	0.25	0.25	0.20
			50–80	–	–	0.15
		0.15–0.3DC	≤ 10	0.25	0.25	0.20
			10–50	0.20	0.20	0.15
			50–80	–	–	0.10
		DC (Slot)	≤ 10	0.25	0.25	0.20
			10–50	0.20	0.20	0.15
Ductile Cast Iron	Tensile Strength $\leq 800MPa$	$\leq 0.15DC$	≤ 20	0.25	0.25	0.20
			20–50	0.20	0.20	0.15
			50–80	–	–	0.10
		0.15–0.3DC	≤ 20	0.20	0.20	0.15
			20–50	0.15	0.15	0.10
			50–80	–	–	0.07
		DC (Slot)	≤ 10	0.15	0.15	0.10
			10–50	0.10	0.10	–
S Titanium Alloy	$\leq 350HB$	$\leq 0.15DC$	≤ 20	0.10	0.10	–
			20–50	0.10	0.10	–
		DC (Slot)	≤ 50	0.08	0.08	–
			$\leq 0.15DC$	≤ 10	0.07	0.07
Heat-resistant Alloy	–	DC (Slot)	≤ 20	0.05	0.05	–
			≤ 20	0.05	0.05	–

Note 1) The above cutting conditions are determined based on high rigidity machine and work materials, where no vibration occurred. Please adjust processing conditions if vibration is generated.

MULTI FUNCTIONAL MILLING

<ALUMINIUM ALLOY TO DIFFICULT-TO-CUT MATERIAL CUTTING>

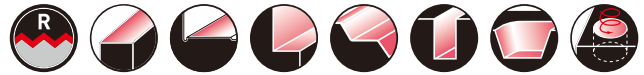

AXD4000

P M K **N** S H

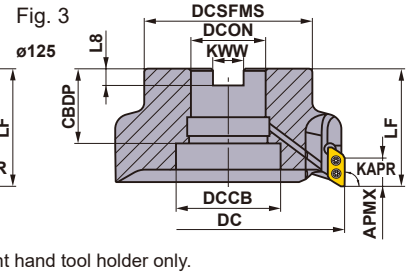
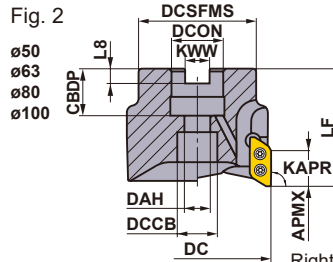
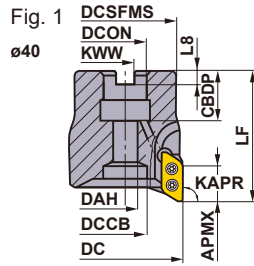

Cutter Diameter DC (mm)	Set Bolt	Geometry
φ40	HFF08043H	① ① ② ③
φ50, φ63	HSC10030H	②
φ80	HSC12035H	②
φ100	HSC16040H	②
φ125	MBA20040H	③

ARBOR TYPE

KAPR : 90°
GAMP : +14°-15° GAMF : +21°-+26°

Type	Insert Corner Radius RE	Order Number	Stock R	Number of Teeth	Dimensions(mm)								WT *2 (kg)	APMX (mm)	Max. Allowable Revolution (min ⁻¹)	Fig.	Clamp Screw	Wrench	Anti-seize Lubricant	Insert	
					DC	LF	DCON	CBDDP	DAH	DCSFMS	KWW	L8									DCCB
A Type	0.4 3.2	AXD4000-040A02RA	★	2	40	50	16	18	8.5	34	8.4	5.6	12	0.3	15.5	41000	1	TS3SB	TKY08D	MK1KS	XDGX1750
		AXD4000-040A03RA	●	3	40	50	16	18	8.5	34	8.4	5.6	12	0.3	15.5	41000	1	TS3SB	TKY08D	MK1KS	
		AXD4000-050A02RA	★	2	50	50	22	20	11	45	10.4	6.3	17	0.4	15.5	35000	2	TS3SB	TKY08D	MK1KS	
		AXD4000-050A04RA	●	4	50	50	22	20	11	45	10.4	6.3	17	0.4	15.5	35000	2	TS3SB	TKY08D	MK1KS	
		AXD4000-063A05RA	●	5	63	50	22	20	11	50	10.4	6.3	17	0.6	15.5	30000	2	TS3SB	TKY08D	MK1KS	
		AXD4000-080A05RA	●	5	80	50	27	23	13	60	12.4	7	20	1	15.5	27000	2	TS3SB	TKY08D	MK1KS	
		AXD4000-100A06RA	●	6	100	63	32	26	17	78	14.4	8	26	2	15.5	23000	2	TS3SB	TKY08D	MK1KS	
AXD4000-125B07RA	●	7	125	63	40	40	—	90	16.4	9	56	2.8	15.5	20000	3	TS3SB	TKY08D	MK1KS			
B Type	4.0 5.0	AXD4000-040A02RB	★	2	40	50	16	18	8.5	34	8.4	5.6	12	0.3	14.8	41000	1	TS3SB	TKY08D	MK1KS	
		AXD4000-040A03RB	●	3	40	50	16	18	8.5	34	8.4	5.6	12	0.3	14.8	41000	1	TS3SB	TKY08D	MK1KS	
		AXD4000-050A02RB	★	2	50	50	22	20	11	45	10.4	6.3	17	0.4	14.8	35000	2	TS3SB	TKY08D	MK1KS	
		AXD4000-050A04RB	●	4	50	50	22	20	11	45	10.4	6.3	17	0.4	14.8	35000	2	TS3SB	TKY08D	MK1KS	
		AXD4000-063A05RB	●	5	63	50	22	20	11	50	10.4	6.3	17	0.6	14.8	30000	2	TS3SB	TKY08D	MK1KS	
		AXD4000-080A05RB	●	5	80	50	27	23	13	60	12.4	7	20	1	14.8	27000	2	TS3SB	TKY08D	MK1KS	
		AXD4000-100A06RB	●	6	100	63	32	26	17	78	14.4	8	26	2	14.8	23000	2	TS3SB	TKY08D	MK1KS	
AXD4000-125B07RB	●	7	125	63	40	40	—	90	16.4	9	56	2.8	14.8	20000	3	TS3SB	TKY08D	MK1KS			

Note 1) The maximum allowable revolutions are set to ensure tool and insert stability.

Before operating the tool read the operational guidance on page K168.

Note 2) When using the tool at high spindle speeds, ensure that the tool and milling chuck are correctly balanced.

Note 3) Note for inserts with a corner radius of 1.6 and above, as corner radius increases the LF and LH dimensions decrease.

*1 Clamp Torque (N · m) : TS3SB=1.5

Use the clamp screw by setting the bundled screw.

*2 WT : Tool Weight

● : Inventory maintained. ★ : Inventory maintained in Japan.

SPARE PARTS > N001
TECHNICAL DATA > P001

ROTATING TOOLS



Fig.1

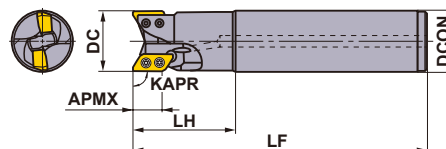
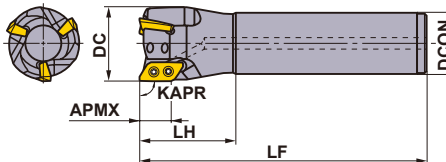

Fig.2



Right hand tool holder only.

SHANK TYPE

KAPR :90°

Type	Insert Corner Radius	Order Number	Stock	Number of Teeth	Dimensions(mm)				APMX (mm)	Max. Allowable Revolution (min ⁻¹)	Fig.	*			
					DC	LF	LH	DCON				Clamp Screw	Wrench	Anti-seize Lubricant	Insert
A Type	0.4 3.2	AXD4000R201SA20SA	●	1	20	110	35	20	15.5	15000	1	TS3SBS	TKY08D	MK1KS	XDGX1750
		AXD4000R252SA25SA	●	2	25	125	50	25	15.5	49000	1	TS3SB	TKY08D	MK1KS	
		AXD4000R252SA25LA	●	2	25	170	80	25	15.5	49000	1	TS3SB	TKY08D	MK1KS	
		AXD4000R282SA25SA	●	2	28	125	50	25	15.5	48500	2	TS3SB	TKY08D	MK1KS	
		AXD4000R282SA25ELA	●	2	28	220	50	25	15.5	48500	2	TS3SB	TKY08D	MK1KS	
		AXD4000R322SA32SA	●	2	32	150	50	32	15.5	48000	1	TS3SB	TKY08D	MK1KS	
		AXD4000R322SA32LA	●	2	32	200	80	32	15.5	48000	1	TS3SB	TKY08D	MK1KS	
		AXD4000R352SA32SA	●	2	35	150	50	32	15.5	45000	2	TS3SB	TKY08D	MK1KS	
		AXD4000R352SA32ELA	★	2	35	250	50	32	15.5	45000	2	TS3SB	TKY08D	MK1KS	
		AXD4000R403SA32SA	●	3	40	150	50	32	15.5	41000	2	TS3SB	TKY08D	MK1KS	
		AXD4000R403SA42SA	★	3	40	170	80	42	15.5	41000	1	TS3SB	TKY08D	MK1KS	
		AXD4000R403SA32ELA	★	3	40	250	50	32	15.5	41000	2	TS3SB	TKY08D	MK1KS	
B Type	4.0 5.0	AXD4000R201SA20SB	●	1	20	110	35	20	14.8	15000	1	TS3SBS	TKY08D	MK1KS	
		AXD4000R252SA25SB	●	2	25	125	50	25	14.8	49000	1	TS3SB	TKY08D	MK1KS	
		AXD4000R252SA25LB	●	2	25	170	80	25	14.8	49000	1	TS3SB	TKY08D	MK1KS	
		AXD4000R282SA25SB	★	2	28	125	50	25	14.8	48500	2	TS3SB	TKY08D	MK1KS	
		AXD4000R282SA25ELB	●	2	28	220	50	25	14.8	48500	2	TS3SB	TKY08D	MK1KS	
		AXD4000R322SA32SB	●	2	32	150	50	32	14.8	48000	1	TS3SB	TKY08D	MK1KS	
		AXD4000R322SA32LB	●	2	32	200	80	32	14.8	48000	1	TS3SB	TKY08D	MK1KS	
		AXD4000R352SA32SB	★	2	35	150	50	32	14.8	45000	2	TS3SB	TKY08D	MK1KS	
		AXD4000R352SA32ELB	●	2	35	250	50	32	14.8	45000	2	TS3SB	TKY08D	MK1KS	
		AXD4000R403SA32SB	●	3	40	150	50	32	14.8	41000	2	TS3SB	TKY08D	MK1KS	
		AXD4000R403SA42SB	★	3	40	170	80	42	14.8	41000	1	TS3SB	TKY08D	MK1KS	
		AXD4000R403SA32ELB	★	3	40	250	50	32	14.8	41000	2	TS3SB	TKY08D	MK1KS	

Note 1) The maximum allowable revolutions are set to ensure tool and insert stability.

Before operating the tool read the operational guidance on page K168.

Note 2) When using the tool at high spindle speeds, ensure that the tool and milling chuck are correctly balanced.



Note 3) Note for inserts with a corner radius of 1.6 and above, as corner radius increases the LF and LH dimensions decrease.

* Clamp Torque (N · m) : TS3SBS=1.5, TS3SB=1.5

● : Inventory maintained. ★ : Inventory maintained in Japan.

(10 inserts in one case)

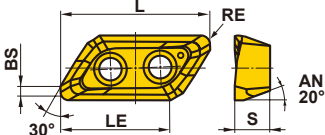



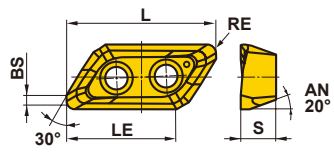







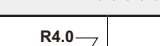









INSERTS

Work Material	N	Aluminium Alloy	●	✦	✦	Cutting Conditions (Guide):					Geometry
	S	Titanium Alloy				●	:Stable Cutting	●	:General Cutting	✦	
						Honing : F :Sharp E :Round					
Shape	Order Number	Class	Honing	Stock			Dimensions (mm)				
				Coated		Carbide	L	LE	S	BS	RE*
				LC15TF	MP9120	TF15					
GL Breaker 	XDGX175004PDFR-GL	G F	★	●			23	16.9	5	1.7	0.4
	XDGX175008PDFR-GL	G F	★	●			23	17	5	1.3	0.8
	XDGX175012PDFR-GL	G F	★	●			23	17	5	0.9	1.2
	XDGX175016PDFR-GL	G F	★	●			22	16.4	5	1.4	1.6
	XDGX175020PDFR-GL	G F	★	●			22	16.4	5	1.0	2.0
	XDGX175024PDFR-GL	G F	★	●			22	16.4	5	0.6	2.4
	XDGX175030PDFR-GL	G F	★	●			21.1	16.1	5	0.8	3.0
	XDGX175032PDFR-GL	G F	★	●			21.1	16.1	5	0.6	3.2
	XDGX175040PDFR-GL	G F	★	●			20	15.6	5	0.8	4.0
	XDGX175050PDFR-GL	G F	★	●			19.4	15.3	5	0.4	5.0
GM Breaker 	XDGX175004PDER-GM	G E		●			23	17	5	1.7	0.4
	XDGX175008PDER-GM	G E		●			23	17	5	1.2	0.8
	XDGX175012PDER-GM	G E		●			23	17	5	0.9	1.2
	XDGX175016PDER-GM	G E		●			22	15.9	5	1.3	1.6
	XDGX175020PDER-GM	G E		●			22	15.9	5	0.8	2.0
	XDGX175024PDER-GM	G E		●			22	15.9	5	0.4	2.4
	XDGX175030PDER-GM	G E		●			21.1	16	5	0.6	3.0
	XDGX175032PDER-GM	G E		●			21.1	16	5	0.4	3.2
	XDGX175040PDER-GM	G E		●			20	14.8	5	0.5	4.0
	XDGX175050PDER-GM	G E		●			19.4	15	5	0.3	5.0
GM Breaker 	XDGX175004PDFR-GM	G F				●	23	17	5	1.7	0.4
	XDGX175008PDFR-GM	G F				●	23	17	5	1.2	0.8
	XDGX175012PDFR-GM	G F				●	23	17	5	0.9	1.2
	XDGX175016PDFR-GM	G F				●	22	15.9	5	1.3	1.6
	XDGX175020PDFR-GM	G F				●	22	15.9	5	0.8	2.0
	XDGX175024PDFR-GM	G F				●	22	15.9	5	0.4	2.4
	XDGX175030PDFR-GM	G F				●	21.1	16	5	0.6	3.0
	XDGX175032PDFR-GM	G F				●	21.1	16	5	0.4	3.2
	XDGX175040PDFR-GM	G F				●	20	14.8	5	0.5	4.0
	XDGX175050PDFR-GM	G F				●	19.4	15	5	0.3	5.0



* Be careful because corner R(RE) has a different shape than machined workpiece R.
 When a GM breaker is recommended, stress the dimensional precision of the workpiece shape.

HOLDER AND INSERT CORNER RADIUS COMBINATION

Holder	A Type Holder								B Type Holder	
	AXD4000-  A AXD4000R-  A								AXD4000-  B AXD4000R-  B	
Applicable Insert Corner R (RE)										
	XDGX 175004PD-R- 	XDGX 175008PD-R- 	XDGX 175012PD-R- 	XDGX 175016PD-R- 	XDGX 175020PD-R- 	XDGX 175024PD-R- 	XDGX 175030PD-R- 	XDGX 175032PD-R- 	XDGX 175040PD-R- 	XDGX 175050PD-R- 

Please note that there is no compatibility between an insert for A type holder and for B type holder.

AXD4000 Selection of insert

It is necessary to choose the best insert according to the cutting conditions. Please select an insert from the tables below. 1st recommendation for stable cutting condition is the GL breaker with a strong cutting edge.

Selection of insert according to the feed per tooth and the required cutting depth

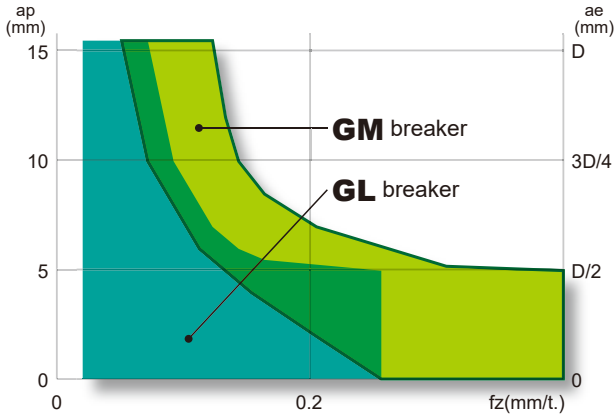

Selection of insert according to the width of cut and the required cutting depth

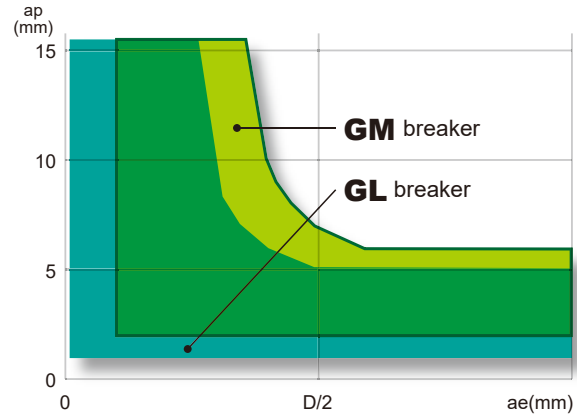

1st recommendation for machining aluminium alloys is GL breaker.

Under high-load conditions such as deep or high feed cutting, it is advisable to use the GM breaker.

Selection of insert according to cutting edge

Insert type

Sharp cutting edge

Sharp cutting edge

PVD coating and Round-type honing

GL TF15/LC15TF
Low cutting resistance

GM TF15
Tougher cutting edge

GM MP9120
Tougher cutting edge & wear resistance
Machining of difficult-to-cut materials & aluminium

Selection of insert according to wear resistance

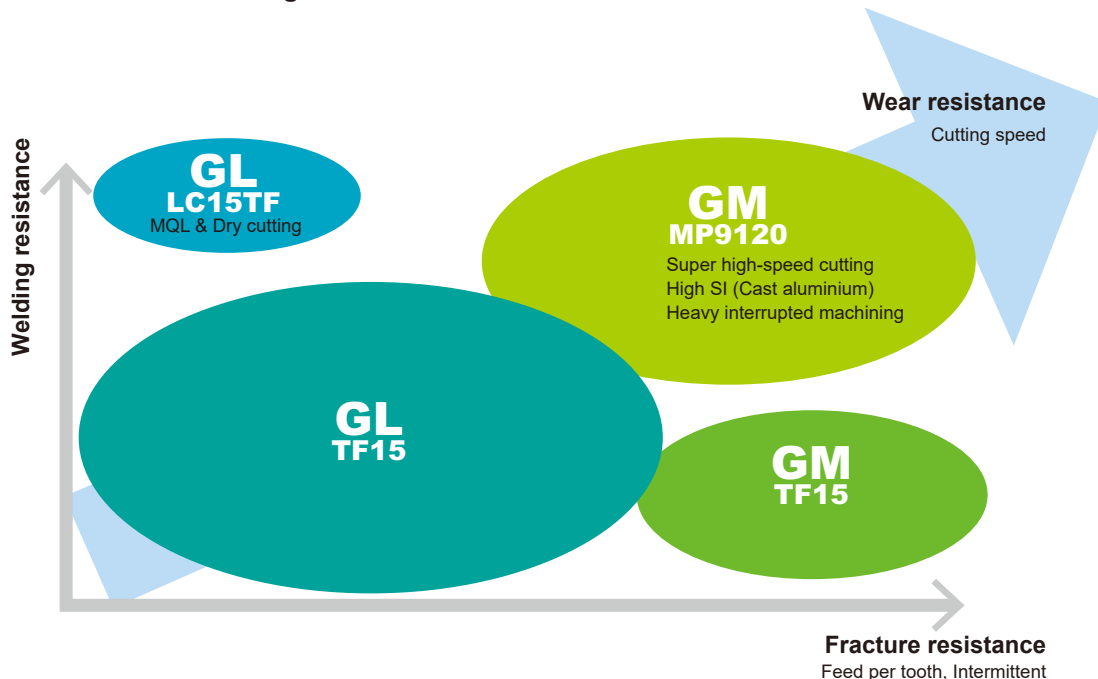

ROTATING TOOLS

K

RECOMMENDED CUTTING CONDITIONS

■ Cutting Speed

Work Material		Grade	Breaker	Cutting Speed V _c (mm/min)	
N	Aluminium Alloy (A6061, A7075 etc)	TF15 LC15TF	GL	1000 (200–3000)	
		TF15 MP9120	GM	1000 (200–3000)	
	Aluminium Alloy (AC4B, ADC12, A390 etc)	5%≤Si≤10% Si>10%	MP9120	GM	1000 (200–3000)
S	Titanium Alloy (Ti-6Al-4V etc)	—	MP9120	GM	40 (30–60)

■ Depth of Cut / Feed per Tooth

Work Material	Breaker	Cutting Width ae (mm)	Depth of Cut ap (mm)	Feed per Tooth (mm/t.)									
				Cutting Edge Diameter DC (mm)									
				20	25, 28	32, 35	40	50, 63, 80	100, 125				
Aluminium Alloy (A6061, A7075 etc)	Si<5%	GL	≤0.25 DC	≤ 5	≤ 0.05	≤ 0.25	≤ 0.25	≤ 0.25	≤ 0.25	≤ 0.25	≤ 0.25		
				≤ 10	≤ 0.05	≤ 0.2	≤ 0.2	≤ 0.2	≤ 0.2	≤ 0.2	≤ 0.2		
				≤ 14.5	≤ 0.05	≤ 0.15	≤ 0.15	≤ 0.15	≤ 0.15	≤ 0.15	≤ 0.15		
			≤0.5 DC	≤ 5	≤ 0.05	≤ 0.25	≤ 0.25	≤ 0.25	≤ 0.25	≤ 0.25	≤ 0.25		
				≤ 10	—	≤ 0.2	≤ 0.2	≤ 0.2	≤ 0.2	≤ 0.2	≤ 0.2		
				≤ 14.5	—	≤ 0.15	≤ 0.15	≤ 0.15	≤ 0.15	≤ 0.15	≤ 0.15		
		≤0.75 DC	≤ 5	≤ 0.05	≤ 0.25	≤ 0.25	≤ 0.25	≤ 0.25	≤ 0.25	≤ 0.25			
			≤ 10	—	≤ 0.2	≤ 0.2	≤ 0.2	≤ 0.2	≤ 0.2	≤ 0.2			
			≤ 14.5	—	≤ 0.15	≤ 0.15	≤ 0.15	≤ 0.15	≤ 0.15	≤ 0.15			
		DC (Slot)	≤ 5	≤ 0.05	≤ 0.25	≤ 0.25	≤ 0.25	≤ 0.25	≤ 0.25	≤ 0.25			
		Aluminium Alloy (A6061, A7075 etc)	Si<5%	GM	≤0.25 DC	≤ 5	≤ 0.05	≤ 0.35	≤ 0.35	≤ 0.4	≤ 0.4	≤ 0.4	
						≤ 10	≤ 0.05	≤ 0.3	≤ 0.3	≤ 0.35	≤ 0.35	≤ 0.35	≤ 0.35
≤ 14.5	≤ 0.05					≤ 0.25	≤ 0.25	≤ 0.3	≤ 0.3	≤ 0.3	≤ 0.3		
≤0.5 DC	≤ 5				≤ 0.05	≤ 0.35	≤ 0.35	≤ 0.35	≤ 0.4	≤ 0.4	≤ 0.4		
	≤ 10				—	≤ 0.3	≤ 0.3	≤ 0.3	≤ 0.35	≤ 0.35	≤ 0.35		
	≤ 14.5				—	≤ 0.2	≤ 0.25	≤ 0.25	≤ 0.3	≤ 0.3	≤ 0.3		
≤0.75 DC	≤ 5			≤ 0.05	≤ 0.3	≤ 0.3	≤ 0.3	≤ 0.35	≤ 0.35	≤ 0.35			
	≤ 10			—	≤ 0.25	≤ 0.25	≤ 0.25	≤ 0.3	≤ 0.3	≤ 0.3			
	≤ 14.5			—	≤ 0.2	≤ 0.2	≤ 0.2	≤ 0.25	≤ 0.25	≤ 0.25			
DC (Slot)	≤ 5			≤ 0.05	≤ 0.25	≤ 0.25	≤ 0.3	≤ 0.35	≤ 0.35	≤ 0.35			
Aluminium Alloy (AC4B etc) Aluminium Alloy (ADC12, A390 etc)	5%≤Si≤10% Si>10%			GM	≤0.25 DC	≤ 5	≤ 0.05	≤ 0.35	≤ 0.35	≤ 0.4	≤ 0.4	≤ 0.4	
						≤ 10	≤ 0.05	≤ 0.3	≤ 0.3	≤ 0.35	≤ 0.35	≤ 0.35	≤ 0.35
		≤ 14.5	≤ 0.05			≤ 0.25	≤ 0.25	≤ 0.3	≤ 0.3	≤ 0.3	≤ 0.3		
		≤0.5 DC	≤ 5		≤ 0.05	≤ 0.35	≤ 0.35	≤ 0.35	≤ 0.4	≤ 0.4	≤ 0.4		
			≤ 10		—	≤ 0.3	≤ 0.3	≤ 0.3	≤ 0.35	≤ 0.35	≤ 0.35		
			≤ 14.5		—	≤ 0.2	≤ 0.25	≤ 0.25	≤ 0.3	≤ 0.3	≤ 0.3		
		≤0.75 DC	≤ 5	≤ 0.05	≤ 0.3	≤ 0.3	≤ 0.3	≤ 0.35	≤ 0.35	≤ 0.35			
			≤ 10	—	≤ 0.25	≤ 0.25	≤ 0.25	≤ 0.3	≤ 0.3	≤ 0.3			
			≤ 14.5	—	≤ 0.2	≤ 0.2	≤ 0.2	≤ 0.25	≤ 0.25	≤ 0.25			
		DC (Slot)	≤ 5	≤ 0.05	≤ 0.25	≤ 0.25	≤ 0.3	≤ 0.35	≤ 0.35	≤ 0.35			
		Titanium Alloy (Ti-6Al-4V etc)	—	GM	≤0.25 DC	≤ 5	≤ 0.05	≤ 0.1	≤ 0.1	≤ 0.1	≤ 0.1	≤ 0.1	≤ 0.1
						≤ 10	≤ 0.05	≤ 0.1	≤ 0.1	≤ 0.1	≤ 0.1	≤ 0.1	≤ 0.1
≤ 14.5	≤ 0.05					≤ 0.1	≤ 0.1	≤ 0.1	≤ 0.1	≤ 0.1	≤ 0.1		
≤0.5 DC	≤ 5				≤ 0.05	≤ 0.08	≤ 0.1	≤ 0.1	≤ 0.1	≤ 0.1	≤ 0.1		
	≤ 10				—	≤ 0.08	≤ 0.1	≤ 0.1	≤ 0.1	≤ 0.1	≤ 0.1		
	≤ 14.5				—	≤ 0.08	≤ 0.1	≤ 0.1	≤ 0.1	≤ 0.1	≤ 0.1		
≤0.75 DC	≤ 5			≤ 0.05	≤ 0.05	≤ 0.08	≤ 0.1	≤ 0.1	≤ 0.1	≤ 0.1			
	≤ 10			—	≤ 0.05	≤ 0.08	≤ 0.1	≤ 0.1	≤ 0.1	≤ 0.1			
	≤ 14.5			—	≤ 0.05	≤ 0.08	≤ 0.1	≤ 0.1	≤ 0.1	≤ 0.1			
DC (Slot)	≤ 5			≤ 0.05	≤ 0.05	≤ 0.05	≤ 0.05	≤ 0.05	≤ 0.05	≤ 0.05			

Note 1) The above cutting conditions are determined based on high workpiece and machine rigidity, where no vibration occurred. If vibrations occur make adjustments according to the machining conditions.

Note 2) Vibrations may occur in the following conditions:

When using long tool overhang.

When pocket machining corner radii.

When the workpiece has poor clamping rigidity or when the machine rigidity or workpiece rigidity is low, vibrations can occur easily, if so, reduce cutting conditions such as width and depth of cut and feed per tooth.

ROTATING TOOLS

■ RAMPING/HELICAL MILLING

● RAMPING

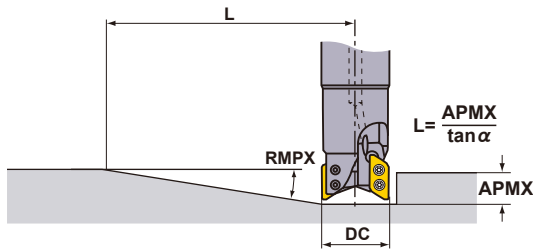

● HELICAL MILLING

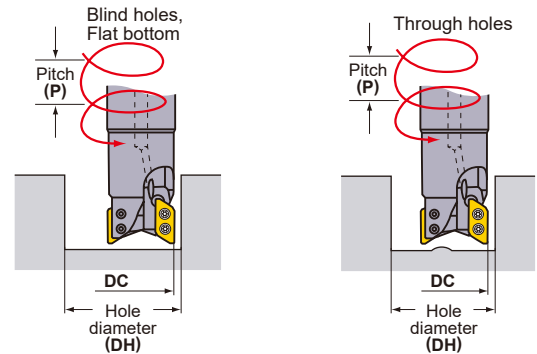

ROTATING TOOLS

K

RAMPING/HELICAL MILLING (Aluminium Alloy)

Holder Type	Cutting Edge Diameter DC (mm)	Insert Corner R RE (mm)	Ramping		Helical Milling (Blind Hole, Flat Bottom)				Helical Milling	
			Maximum Ramping Angle RMPX	Minimum Distance L *1 (mm)	Maximum Hole Diameter DH max. (mm)	Maximum Pitch P max. (mm)	Minimum Hole Diameter DH min. (mm)	Maximum Pitch P max. (mm)	Minimum Hole Diameter DH min. (mm)	Maximum Pitch P max. (mm)
A type	20	0.4-1.2	20.7°	42	37.1 *2	14	36.1	14	22	2
		1.6-2.4	19.9°	43	34.7 *3	13	34.6	13	22	2
		3.0-3.2	18.9°	46	33.1 *4	12	33.3	12	22	1
	25	0.4-1.2	23.1°	37	47.1 *2	14	46	14	31.6	8
		1.6-2.4	22.0°	39	44.7 *3	13	44.4	13	31.6	8
		3.0-3.2	18.7°	46	43.1 *4	12	43	12	31.6	7
	28	0.4-1.2	19.2°	45	53.1 *2	14	52	14	36	8
		1.6-2.4	18.5°	47	50.7 *3	13	50.4	13	36	8
		3.0-3.2	16.7°	52	49.1 *4	12	48.9	12	36	7
	32	0.4-1.2	15.4°	57	61.1 *2	14	59.9	14	45.5	11
		1.6-2.4	14.7°	60	58.7 *3	13	58.3	13	45.5	11
		3.0-3.2	13.8°	64	57.1 *4	12	56.8	12	45.5	10
	35	0.4-1.2	13.4°	66	67.1 *2	14	65.8	14	50	11
		1.6-2.4	12.7°	69	64.7 *3	13	64.3	13	50	10
		3.0-3.2	11.8°	75	63.1 *4	12	62.8	12	50	9
	40	0.4-1.2	11.1°	80	76.7 *2	14	75.9	14	61.5	13
		1.6-2.4	10.4°	85	74.3 *3	13	74.2	13	61.5	12
		3.0-3.2	9.7°	91	72.7 *4	12	72.7	12	61.5	11
	50	0.4-1.2	8.2°	108	96.7 *2	14	95.6	14	81.4	14
		1.6-2.4	7.6°	117	94.3 *3	13	94	13	81.4	13
		3.0-3.2	6.9°	129	92.7 *4	12	92.4	12	81.4	11
	63	0.4-1.2	6.1°	146	122.7 *2	14	121.6	14	107.4	14
		1.6-2.4	5.6°	159	120.3 *3	13	119.9	13	107.4	13
		3.0-3.2	5.2°	171	118.7 *4	12	118.4	12	107.4	12
80	0.4-1.2	4.6°	193	156.7 *2	14	155.6	14	141.4	14	
	1.6-2.4	4.2°	212	154.3 *3	13	153.9	13	141.4	13	
	3.0-3.2	3.8°	234	152.7 *4	12	152.4	12	141.4	12	
100	0.4-1.2	3.5°	254	196.7 *2	14	195.5	14	181.5	14	
	1.6-2.4	3.2°	278	194.3 *3	13	193.9	13	181.5	13	
	3.0-3.2	2.9°	306	192.7 *4	12	192.3	12	181.5	12	
125	0.4-1.2	2.7°	329	246.7 *2	14	245.5	14	231.5	14	
	1.6-2.4	2.5°	356	244.3 *3	13	243.8	13	231.5	13	
	3.0-3.2	2.3°	386	242.7 *4	12	242.3	12	231.5	12	

Note 1) Ramping, helical cutting, and drilling are not recommended for machining of steel and titanium alloys.

*1 Using the maximum ramping angle, the distance to reach the maximum depth of cut is as follows:

$L = (\text{maximum depth of cut} / \tan \alpha)$. Maximum depth of cut A type is 15.5mm, B type is 14.8mm.

*2 Corner radius of 1.2mm. For other corner radii, use the following formula. $\{(\text{cutting edge diameter DC}) - (\text{corner radius RE}) - 0.25\} \times 2$

*3 Corner radius of 2.4mm. For other corner radii, use the following formula. $\{(\text{cutting edge diameter DC}) - (\text{corner radius RE}) - 0.25\} \times 2$

*4 Corner radius of 3.2mm. For other corner radii, use the following formula. $\{(\text{cutting edge diameter DC}) - (\text{corner radius RE}) - 0.25\} \times 2$

Holder Type	Cutting Edge Diameter DC (mm)	Insert Corner R RE (mm)	Ramping		Helical Milling (Blind Hole, Flat Bottom)				Helical Milling	
			Maximum Ramping Angle RMPX	Minimum Distance L *1 (mm)	Maximum Hole Diameter DH max. (mm)	Maximum Pitch P max. (mm)	Minimum Hole Diameter DH min. (mm)	Maximum Pitch P max. (mm)	Minimum Hole Diameter DH min. (mm)	Maximum Pitch P max. (mm)
B type	20	4	17.5°	47	31.5	10	31.8	10	22	1
		5	16.6°	71	29.5	6	31.1	7	22	1
	25	4	15.1°	55	41.5	10	41.4	10	31.7	5
		5	13.7°	61	39.5	9	40.6	9	31.7	5
	28	4	14.1°	59	47.5	10	47.2	10	36	6
		5	13°	65	45.5	9	46.4	9	36	5
	32	4	12.7°	66	55.5	10	55.1	10	45.5	9
		5	12°	70	53.5	9	54.3	9	45.5	8
	35	4	10.8°	78	61.5	10	61	10	50	8
		5	10.2°	83	59.5	9	60.2	9	50	8
	40	4	8.8°	96	71.1	10	70.9	10	61.5	10
		5	8.2°	103	69.1	9	70.1	9	61.5	9
	50	4	6.3°	135	91.1	10	90.6	10	81.3	10
		5	5.8°	146	89.1	9	89.8	9	81.3	9
	63	4	4.6°	184	117.1	10	116.6	10	107.4	10
		5	4.2°	202	115.1	9	115.7	9	107.3	9
	80	4	3.4°	250	151.1	10	150.5	10	141.4	10
		5	3.1°	274	149.1	9	149.6	9	141.4	9
	100	4	2.6°	326	191.1	10	190.5	10	181.4	10
		5	2.4°	354	189.1	9	189.6	9	181.4	9
125	4	2°	424	241.1	10	240.5	10	231.4	10	
	5	1.8°	471	239.1	9	239.6	9	229.9	9	

Note 1) The recommended ramping feed is 0.05mm/tooth or under.

*1 Using the maximum ramping angle, the distance to reach the maximum depth of cut is as follows:

$L = (\text{maximum depth of cut} / \tan \alpha)$. Maximum depth of cut A type is 15.5mm, B type is 14.8mm.

*2 Corner radius of 1.2mm. For other corner radii, use the following formula. $\{(\text{cutting edge diameter DC}) - (\text{corner radius RE}) - 0.25\} \times 2$

*3 Corner radius of 2.4mm. For other corner radii, use the following formula. $\{(\text{cutting edge diameter DC}) - (\text{corner radius RE}) - 0.25\} \times 2$

*4 Corner radius of 3.2mm. For other corner radii, use the following formula. $\{(\text{cutting edge diameter DC}) - (\text{corner radius RE}) - 0.25\} \times 2$

Max. Drilling Depth (Aluminium Alloy)

Type	Insert Corner R RE (mm)	Max. Drilling Depth (mm)					
		Cutting Edge Diameter DC (mm)					
		φ20	φ25	φ28	φ32	φ35	φ40-φ125
A type	0.4	5.3	5.2	5.2	5.2	5.3	5.3
	0.8	5.3	5.2	5.2	5.2	5.3	5.3
	1.2	5.3	5.2	5.2	5.2	5.3	5.3
	1.6	4.8	4.6	4.7	4.7	4.9	4.8
	2.0	4.8	4.6	4.7	4.7	4.9	4.8
	2.4	4.8	4.6	4.7	4.7	4.9	4.8
	3.0	4.3	3.7	4.2	4.2	4.4	4.4
	3.2	4.3	3.7	4.2	4.2	4.4	4.4
B type	4.0	3.7	2.7	3.7	3.6	3.8	3.8
	5.0	3.4	2.3	3.3	3.3	3.5	3.5

AXD4000 can be effectively used for pocket machining without the need for a prepared hole.

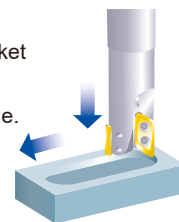

ROTATING TOOLS

MULTI FUNCTIONAL MILLING

<FOR ALUMINIUM ALLOY CUTTING>

90°
KAPR

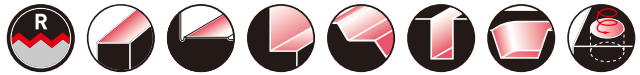

AXD4000A

NEW

P M K **N** S H

ROTATING TOOLS

K



ø50

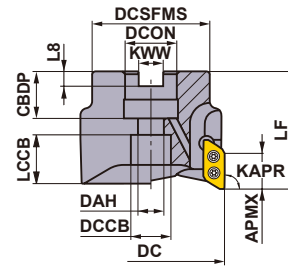

Right hand tool holder only.

Cutter Diameter DC (mm)	Set Bolt	Geometry
ø50	HSC10030H	

ARBOR TYPE

KAPR : 90°
GAMP : +10° GAMF : +21°
With Coolant Hole

DC	Type	Insert Corner Radius RE	Order Number	Stock R	Number of Teeth	Dimensions (mm)		WT (kg)	APMX (mm)	RPMX (min ⁻¹)	 Insert Type
						LF	DCON				
50	D	0.4-3.2	AXD4000A-050A04RD	●	4	50	22	0.4	15.5	34000	XDGX1750
50	E	4.0-5.0	AXD4000A-050A04RE	●	4	50	22	0.4	14.8	34000	XDGX1750

Note 1) The maximum allowable revolutions are set to ensure tool and insert stability.

RPMX (max. rev/min) for holders must also be considered.

Note 2) Tool should be set with balancing quality of G6.3 (ISO1940) or ISO16084, in case over 6000 min⁻¹ spindle rotation.

Note 3) When using the tool at high spindle speeds, ensure that the tool and chuck are correctly balanced.

Note 4) Note for inserts with a corner radius of 1.6 and above, as corner radius increases the LF dimensions decrease.

MOUNTING DIMENSIONS

DC	Order Number	Dimensions (mm)							
		DCON	CBDP	DAH	DCCB	LCCB	DCSFMS	KWW	L8
50	AXD4000A-050A04RD	22	20	11	17	15.4	45	10.4	6.3
50	AXD4000A-050A04RE	22	20	11	17	14.6	45	10.4	6.3

SPARE PARTS





	*		
Clamp Screw		Wrench	Anti-seize Lubricant
TPS3SB		TIP10D	MK1KS

* Clamp Torque (N · m) : TPS3SB = 3.0

Note 1) Clamp screw and wrench of AXD4000A are different from AXD4000.

● : Inventory maintained. ★ : Inventory maintained in Japan.
(10 inserts in one case)

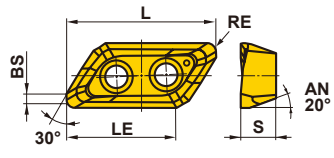









INSERTS

Work Material	N Aluminium Alloys		● ✖		● ✖		● ✖		Cutting Conditions (Guide): ● :Stable Cutting ● :General Cutting ✖ :Unstable Cutting Honing: F :Sharp E :Round					Geometry
	Shape	Order Number	Class	Honing	Stock		Dimensions (mm)							
Coated					Carbide	L	LE	S	BS	RE*				
Strong Cutting Edge Type GM Breaker 	XDGX175004PDFR-GM	G F					●	●	23.0	17.0	5	1.7	0.4	
	XDGX175008PDFR-GM	G F					●	●	23.0	17.0	5	1.2	0.8	
	XDGX175012PDFR-GM	G F					●	●	23.0	17.0	5	0.9	1.2	
	XDGX175016PDFR-GM	G F					●	●	22.0	15.9	5	1.3	1.6	
	XDGX175020PDFR-GM	G F					●	●	22.0	15.9	5	0.8	2.0	
	XDGX175024PDFR-GM	G F					●	●	22.0	15.9	5	0.4	2.4	
	XDGX175030PDFR-GM	G F					●	●	21.1	16.0	5	0.6	3.0	
	XDGX175032PDFR-GM	G F					●	●	21.1	16.0	5	0.4	3.2	
	XDGX175040PDFR-GM	G F					●	●	20.0	14.8	5	0.5	4.0	
	XDGX175050PDFR-GM	G F					●	●	19.4	15.0	5	0.3	5.0	
Strong Cutting Edge Fracture Resistance Type GM Breaker 	XDGX175004PDER-GM	G E	●						23.0	17.0	5	1.7	0.4	
	XDGX175008PDER-GM	G E	●						23.0	17.0	5	1.2	0.8	
	XDGX175012PDER-GM	G E	●						23.0	17.0	5	0.9	1.2	
	XDGX175016PDER-GM	G E	●						22.0	15.9	5	1.3	1.6	
	XDGX175020PDER-GM	G E	●						22.0	15.9	5	0.8	2.0	
	XDGX175024PDER-GM	G E	●						22.0	15.9	5	0.4	2.4	
	XDGX175030PDER-GM	G E	●						21.1	16.0	5	0.6	3.0	
	XDGX175032PDER-GM	G E	●						21.1	16.0	5	0.4	3.2	
	XDGX175040PDER-GM	G E	●						20.0	14.8	5	0.5	4.0	
XDGX175050PDER-GM	G E	●						19.4	15.0	5	0.3	5.0		
Low Cutting Resistance GL Breaker 	XDGX175004PDFR-GL	G F	★				●	●	23.0	16.9	5	1.7	0.4	
	XDGX175008PDFR-GL	G F	★				●	●	23.0	17.0	5	1.3	0.8	
	XDGX175012PDFR-GL	G F	★				●	●	23.0	17.0	5	0.9	1.2	
	XDGX175016PDFR-GL	G F	★				●	●	22.0	16.4	5	1.4	1.6	
	XDGX175020PDFR-GL	G F	★				●	●	22.0	16.4	5	1.0	2.0	
	XDGX175024PDFR-GL	G F	★				●	●	22.0	16.4	5	0.6	2.4	
	XDGX175030PDFR-GL	G F	★				●	●	21.1	16.1	5	0.8	3.0	
	XDGX175032PDFR-GL	G F	★				●	●	21.1	16.1	5	0.6	3.2	
	XDGX175040PDFR-GL	G F	★				●	●	20.0	15.6	5	0.8	4.0	
XDGX175050PDFR-GL	G F	★				●	●	19.4	15.3	5	0.4	5.0		

* The insert nose R differs from radius from the radius formed on the workpiece after machining due to the effects of the axial rake angle at the time of setting. GM breaker is recommended if the priority is on the dimensional precision of the workpiece corner radius.

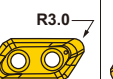
● = NEW

HOLDER AND INSERT CORNER RADIUS COMBINATION

Holder	D Type Holder								E Type Holder	
	AXD4000A-050A04RD								AXD4000A-050A04RE	
Applicable Insert Corner R (RE)										
	XDGX175004PDR	XDGX175008PDR	XDGX175012PDR	XDGX175016PDR	XDGX175020PDR	XDGX175024PDR	XDGX175030PDR	XDGX175032PDR	XDGX175040PDR	XDGX175050PDR

Note 1) Other combinations of holder and insert corner R are not acceptable.

AXD4000A Selection of Insert

It is necessary to choose the best insert according to the cutting conditions. Please select an insert from the tables below.
 1st recommendation for efficient, high load machining with a high speed spindle is the GM breaker with a strong cutting edge.

Selection of insert according to the feed per tooth and the required cutting depth

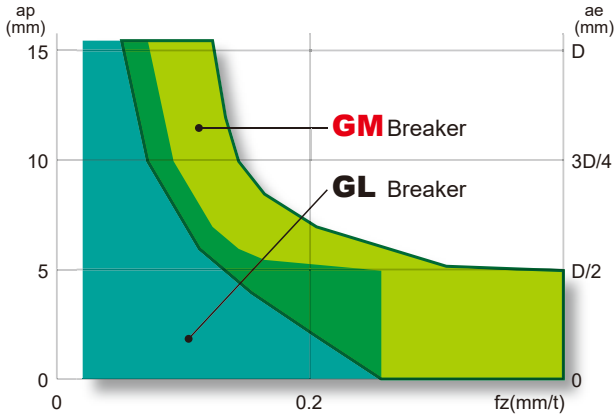

Selection of insert according to the width of cut and the required cutting depth

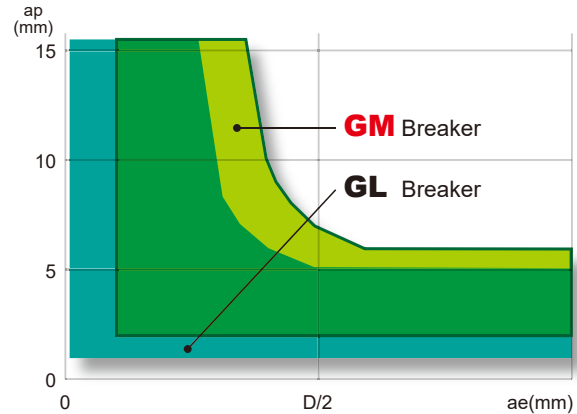

1st recommendation for machining aluminium alloys is GL breaker.
 Under high-load conditions such as deep or high feed cutting, it is advisable to use the GM breaker.

Selection of Insert According to Cutting Edge

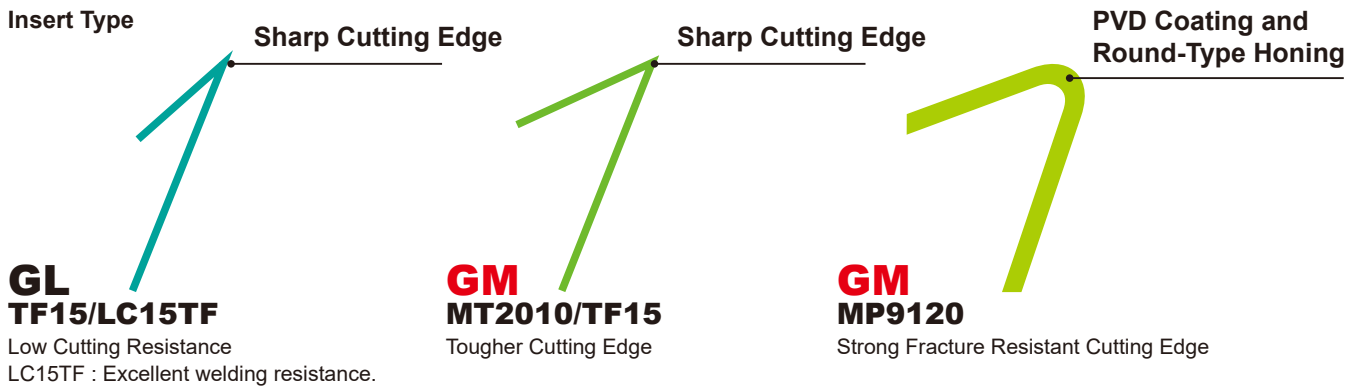

Selection of insert according to wear resistance

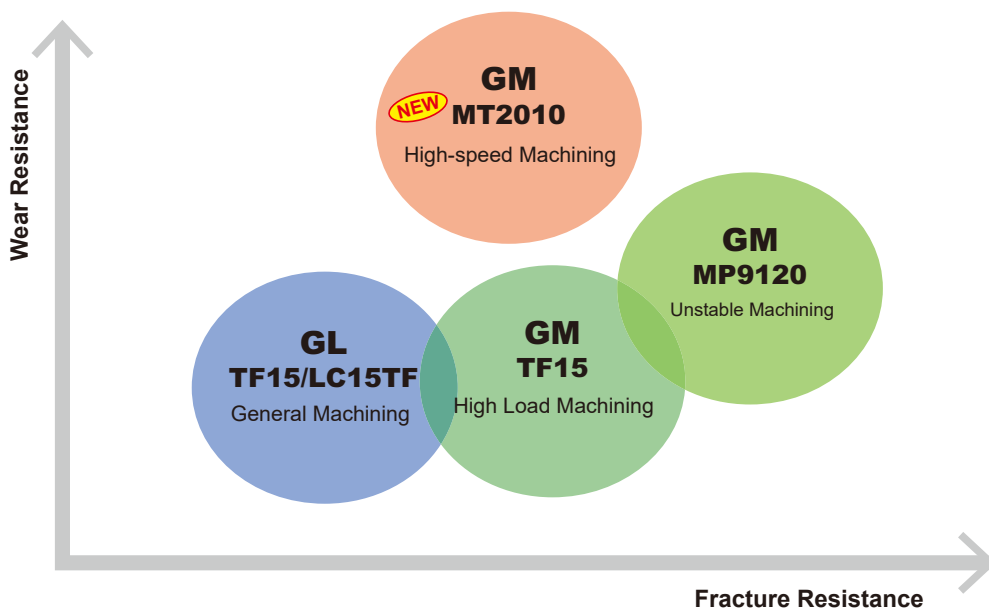

K

ROTATING TOOLS

RECOMMENDED CUTTING CONDITIONS

Work Material	Properties	Grade	Breaker	Cutting Speed V_c (mm/min)	Cutting Width a_e (mm)	Depth of Cut a_p (mm)	Feed per Tooth (mm/t.)
N Aluminium Alloys (A7050, A7075, A2024, A6061 etc) Aluminium-lithium Alloy	Content Si < 5%	MT2010 TF15 MP9120	GM	4000(2000—5000)	≤ 0.5 DC	≤ 5	≤ 0.35
						≤ 10	≤ 0.30
						≤ 14.5	≤ 0.25
					≤ 0.75 DC	≤ 5	≤ 0.30
						≤ 10	≤ 0.25
						≤ 14.5	≤ 0.20
		DC (Slot)	≤ 5	≤ 0.30			
		TF15 LC15TF	GL	4000(2000—5000)	≤ 0.75 DC	≤ 5	≤ 0.20
						≤ 10	≤ 0.15
						≤ 14.5	≤ 0.10
					DC (Slot)	≤ 5	≤ 0.20

Note 1) The above cutting conditions are determined based on high work materials and machine rigidity, where no vibration occurred. If vibrations occur make adjustments according to the machining conditions.

Note 2) Vibrations may occur in the following conditions:

- When using a long tool overhang.
- When pocket machining corner radii.
- When the work materials has poor clamping rigidity or when the machine rigidity or work material rigidity is low, vibrations can occur easily, if so, reduce cutting conditions such as width and depth of cut and feed per tooth.

K

ROTATING TOOLS

RAMPING / HELICAL MILLING / DRILLING

RAMPING

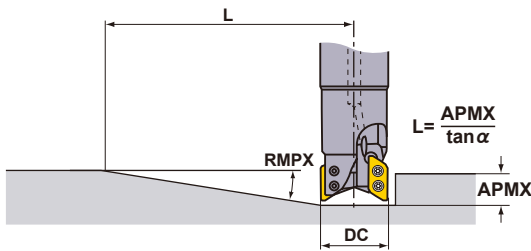

HELICAL MILLING

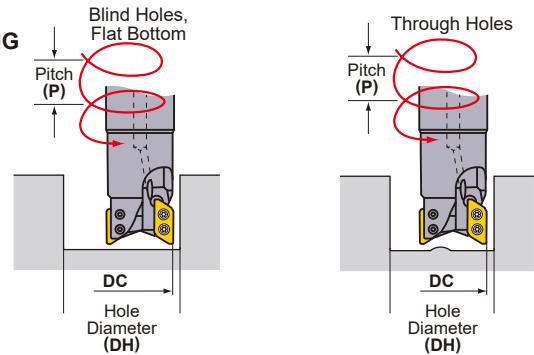

Refer to the table below for cutting conditions. For feed per tooth and cutting speed, follow the cutting conditions for slot milling.

DC (mm)	Type	Insert Corner R RE (mm)	Ramping		Helical Milling (Blind Hole, Flat Bottom)			Helical Milling (Through Hole)		Drilling
			RMPX	L *1 (mm)	DH max. (mm)	DH min. (mm)	P max. (mm)	DH min. (mm)	P max. (mm)	
50	D	0.4—1.2	8.2°	108	96.8 *2	95.4	14	81.2	14	5.5
		1.6—2.4	7.6°	117	94.4 *3	93.6	13	81.2	13	5.0
		3.0—3.2	6.9°	129	92.8 *4	92.0	12	81.2	12	4.5
	E	4.0	6.3°	135	91.2	90.0	10	81.2	10	3.9
		5.0	5.8°	146	89.2	88.8	9	81.2	9	3.6

*1 Using the maximum ramping angle, the distance to reach the maximum depth of cut is as follows:

$L = (\text{maximum depth of cut } APMX / \tan \alpha)$. Maximum depth of cut D type is 15.5mm, E type is 14.8mm.

*2 Corner radius of 1.2mm. For other corner radii, use the following formula. $\{(\text{cutting edge diameter } DC) - (\text{corner radius } RE) - 0.3\} \times 2$

*3 Corner radius of 2.4mm. For other corner radii, use the following formula. $\{(\text{cutting edge diameter } DC) - (\text{corner radius } RE) - 0.3\} \times 2$

*4 Corner radius of 3.2mm. For other corner radii, use the following formula. $\{(\text{cutting edge diameter } DC) - (\text{corner radius } RE) - 0.3\} \times 2$

Note 1) The recommended ramping feed is 0.05mm/t. or under.

ROTATING TOOLS

MULTI FUNCTIONAL MILLING

<FOR ALUMINIUM ALLOY CUTTING>

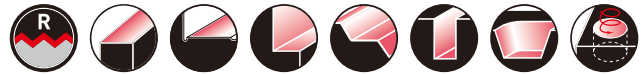

AXD7000

P M K **N** S H



ROTATING TOOLS

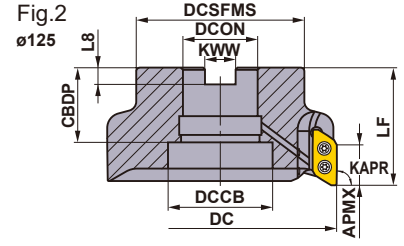
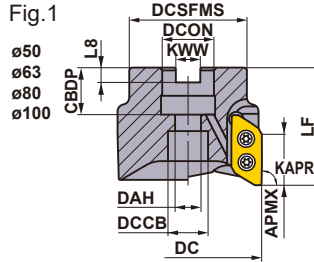

Right hand tool holder only.

ARBOR TYPE

KAPR :90°
GAMP: +11° GAMF: +26° - +29°

Cutter Diameter DC (mm)	Set Bolt	Geometry
ø50, ø63	HSC10030H	① ②
ø80	HSC12035H	
ø100	HSC16040H	②
ø125	MBA20040H	

Type	Insert Corner Radius RE	Order Number	Stock R	Number of Teeth	Dimensions (mm)								*2 WT (kg)	APMX (mm)	Max. Allowable Revolution (min ⁻¹)	Fig. *					
					DC	LF	DCON	CBDP	DAH	DCSFMS	KWW	L8									DCCB
A Type	0.8 3.2	AXD7000-050A03RA	●	3	50	50	22	20	11	45	10.4	6.3	17	0.4	21	30000	1	TS4SBL	TKY15D	MK1KS	XDGX2270
		AXD7000-063A03RA	●	3	63	50	22	20	11	50	10.4	6.3	17	0.5	21	25000	1	TS4SBL	TKY15D	MK1KS	
		AXD7000-080A04RA	●	4	80	63	27	23	13	63	12.4	7	20	1.2	21	23000	1	TS4SBL	TKY15D	MK1KS	
		AXD7000-100A05RA	●	5	100	63	32	26	17	70	14.4	8	26	1.8	21	19000	1	TS4SBL	TKY15D	MK1KS	
		AXD7000-125B06RA	●	6	125	63	40	40	-	90	16.4	9	56	2.7	21	16000	2	TS4SBL	TKY15D	MK1KS	
B Type	4.0 5.0	AXD7000-050A03RB	●	3	50	50	22	20	11	45	10.4	6.3	17	0.4	20.4	30000	1	TS4SBL	TKY15D	MK1KS	
		AXD7000-063A03RB	●	3	63	50	22	20	11	50	10.4	6.3	17	0.5	20.4	25000	1	TS4SBL	TKY15D	MK1KS	
		AXD7000-080A04RB	●	4	80	63	27	23	13	63	12.4	7	20	1.2	20.4	23000	1	TS4SBL	TKY15D	MK1KS	
		AXD7000-100A05RB	●	5	100	63	32	26	17	70	14.4	8	26	1.8	20.4	19000	1	TS4SBL	TKY15D	MK1KS	
		AXD7000-125B06RB	●	6	125	63	40	40	-	90	16.4	9	56	2.7	20.4	16000	2	TS4SBL	TKY15D	MK1KS	

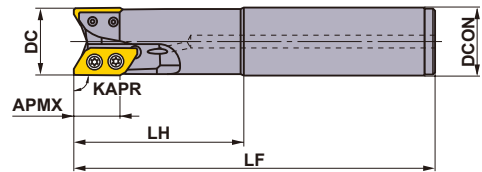

SHANK TYPE

KAPR:90°

Right hand tool holder only.

Type	Insert Corner Radius RE	Order Number	Stock R	Number of Teeth	Dimensions (mm)				APMX (mm)	Max. Allowable Revolution (min ⁻¹)	*1			
					DC	LF	LH	DCON						
A Type	0.8 3.2	AXD7000R322SA32SA	●	2	32	170	80	32	21	41000	TS4SB	TKY15D	MK1KS	XDGX2270
		AXD7000R402SA40SA	●	2	40	170	80	40	21	36000	TS4SBL	TKY15D	MK1KS	
B Type	4.0 5.0	AXD7000R322SA32SB	●	2	32	170	80	32	20.4	41000	TS4SB	TKY15D	MK1KS	
		AXD7000R402SA40SB	●	2	40	170	80	40	20.4	36000	TS4SBL	TKY15D	MK1KS	

Note 1) The maximum allowable spindle speeds are set to ensure tool and insert stability.

Before use read the operational guidance on page K168.

Note 2) When using the tool at high spindle speeds, ensure that the tool and arbor are correctly balanced.

Note 3) Note for inserts with a corner radius of 3.0 and above, as corner radius increases the LF and LH dimensions decrease.

*1 Clamp Torque (N · m) : TS4SB=3.5, TS4SBL=3.5

Use the clamp screw by setting the bundled screw.

*2 WT : Tool Weight

● : Inventory maintained. ★ : Inventory maintained in Japan.

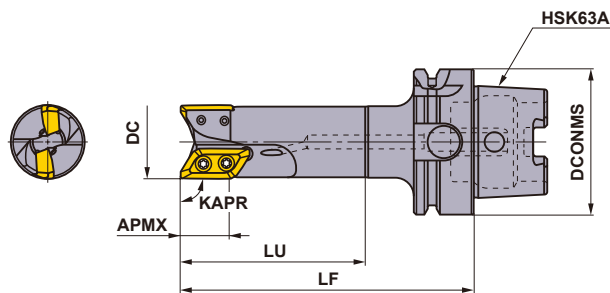

HSK63A MONOBLOCK KAPR :90°

Right hand tool holder only.

Type	Insert Corner RE	Order Number	Stock R	Number of Teeth	Dimensions (mm)				APMX (mm)	RMPX*2	Max. Allowable Revolution (min ⁻¹)	Clamp Screw*1	Wrench	Anti-seize Lubricant	Insert
					DC	LF	LU	DCONMS							
A type	0.8	AXD7000R03202A-H63A	●	2	32	127	80	63	21	19°	41000	TS4SB	TKY15D	MK1KS	XDGX227000 PDFR-GL
	1	AXD7000R04002A-H63A	●	2	40	132	85	63	21	13°	36000	TS4SBL	TKY15D	MK1KS	
	3.2	AXD7000R05003A-H63A	●	3	50	137	90	63	21	9°	30000	TS4SBL	TKY15D	MK1KS	

Note 1) The maximum allowable spindle speeds are set to ensure tool and insert stability.

Before use read the operational guidance on page K168.

Note 2) When using the tool at high spindle speeds, ensure that the tool and arbor are correctly balanced.

Note 3) Note for inserts with a corner radius of 3.0 and above, as corner radius increases the LF and LU dimensions decrease.

Note 4) There is no hole for a data chip

Note 5) The HSK63A shank type has a built-in coolant pipe for installation.

*1 Clamp Torque (N · m) : TS4SB=3.5, TS4SBL=3.5

*2 RMPX : Max. Ramping Angle

INSERTS

Work Material	N	Aluminium Alloy	Cutting Conditions (Guide) :		Honing :							
			●	●	●	●	✱	F : Sharp				
Shape	Order Number	Class	Honing	Stock		Dimensions (mm)					Geometry	
				Coated	Carbide	L	LE	S	BS	RE		
			LC15TF		TF15							
	XDGX227008PDFR-GL	G	F	★	●	30	21.6	7	2.0	0.8		
	XDGX227016PDFR-GL	G	F	★	●	30	21.7	7	1.2	1.6		
	XDGX227020PDFR-GL	G	F	★	●	30	21.7	7	0.8	2.0		
	XDGX227030PDFR-GL	G	F	★	●	28.8	21.2	7	0.8	3.0		
	XDGX227032PDFR-GL	G	F	★	●	28.8	21.2	7	0.6	3.2		
	XDGX227040PDFR-GL	G	F	★	●	27.5	20.6	7	0.9	4.0		
	XDGX227050PDFR-GL	G	F	★	●	27	20.3	7	0.4	5.0		

HOLDER AND INSERT CORNER RADIUS COMBINATION

Holder	A Type Holder					B Type Holder	
	AXD7000-○○○○○○○○○○A AXD7000R○○○○○○○○○○A AXD7000R○○○○○○○○○○A-H63A						
Applicable Insert Corner R (RE)							
	XDGX227008PDFR-GL	XDGX227016PDFR-GL	XDGX227020PDFR-GL	XDGX227030PDFR-GL	XDGX227032PDFR-GL	XDGX227040PDFR-GL	XDGX227050PDFR-GL

Please note that there is no compatibility between an insert for A type holder and that of for B type holder.

CAUTION FOR USE

Procedure for attaching inserts

- 1) Clean the seat by air blowing or with a brush before installing the insert.
- 2) Tighten the clamp screw using the accessory wrench while pressing the insert against the seat.
- 3) Tighten the clamp screw as shown in Figure 1.
- 4) Coat the clamp screw with anti-seize compound and tighten it to the specified tightening torque.
The tightening torque is shown below.
AXD7000 3.5N•m(2.58ft•lb)
AXD4000 1.5N•m(1.11ft•lb)
- 5) The clamp screw is an important part in ensuring safety. Purchase an official product from Mitsubishi Materials. When using above the revolutions shown in Table 2, replacing the clamp screw simultaneously with insert replacement is recommended.
- 6) Check that there is no clearance at the insert seat surface.

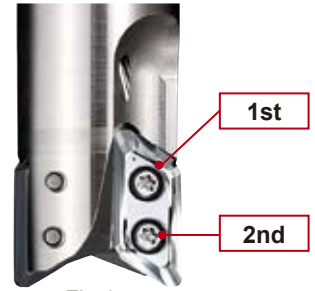
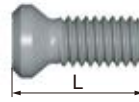

Fig.1

Type	AXD4000		AXD7000	
Cutting Edge Diameter DC(mm)	ø20	ø25-ø125	ø32	ø40-ø125
Clamp Screw Number	TS3SBS	TS3SB	TS4SB	TS4SBL
Overall Length L(mm)	6.5	8	9	10.5



Installation of arbor type

- 1) Clean the inside and face of the hole and the arbor face before installing the body to the arbor.
- 2) Set the body to the arbor and tighten it. Refer to the table shown below for the tightening torque.
- 3) The set bolt supplied with the AXD is a special coolant through compatible nozzle.

AXD4000

Geometry	Set Bolt	Clamp Torque (N•m)	Cutting Edge Diameter DC(mm)	Fig			
Fig.1	HFF08043H	11	ø40	1			
Fig.2							
Fig.3							
HSC10030H					40	ø50, ø63	2
HSC12035H					80	ø80	2
HSC16040H	150	ø100	2				
MBA20040H	320	ø120	3				

AXD7000

Geometry	Set Bolt	Clamp Torque (N•m)	Cutting Edge Diameter DC(mm)	Fig			
Fig.1	HSC10030H	40	ø50, ø63	1			
Fig.2							
HSC12035H					80	ø80	1
HSC16040H					150	ø100	1
MBA20040H	320	ø120	2				

Table 1 Max. Allowable Revolution

AXD4000

Cutting Edge Diameter DC(mm)	ø25	ø32	ø40	ø50	ø63	ø80	ø100	ø125
Max. Allowable Revolution (min ⁻¹)	49000	48000	41000	35000	30000	27000	23000	20000

AXD7000

Cutting Edge Diameter DC(mm)	ø32	ø40	ø50	ø63	ø80	ø100	ø125
Max. Allowable Revolution (min ⁻¹)	41000	36000	30000	25000	23000	19000	16000

- Even when operating under the maximum allowable spindle speed, if the spindle speed is equal to or higher than the values shown in table 2, it is recommended that the balance quality (with the arbor or milling chuck) conforms to G6.3 or better based on ISO1940. It is also recommended to replace the clamp screws with new ones when changing inserts. Furthermore, ensure to use machines with safety measures in case of cutter breakage.

Note 1) The balance quality of the holder (without inserts and clamp screws) is G6.3 or better at 10,000min⁻¹.

Table 2 Maximum spindle speed when balancing with the arbor or milling chuck has not been achieved

AXD4000

Cutting Edge Diameter DC(mm)	ø25	ø32	ø40	ø50	ø63	ø80	ø100	ø125
Max. Allowable Revolution (min ⁻¹)	12000	9500	7600	6000	4800	3800	3000	2400

AXD7000

Cutting Edge Diameter DC(mm)	ø32	ø40	ø50	ø63	ø80	ø100	ø125
Max. Allowable Revolution (min ⁻¹)	9500	7600	6000	4800	3800	3000	2400

- When setting the spindle speed, take into consideration the maximum allowable spindle speed of the arbor or milling chuck.
- Use the specified set bolt when using the arbor type with through coolant.
- The inserts have sharp cutting edges and handling them with bare hands may cause injuries. Always wear safety gloves when handling the inserts.

RECOMMENDED CUTTING CONDITIONS

■ Cutting Speed

Work Material		Grade	Breaker	Cutting Speed V_c (mm/min)	
N	Aluminium Alloy	Si<5%	LC15TF	GL	1000 (200–3000)
		Si<5%	TF15	GL	1000 (200–3000)
	5%≤Si≤10% Si>10%	LC15TF	GL	1000 (200–3000)	

■ Depth of Cut / Feed per Tooth

Work Material	Breaker	Cutting Width ae (mm)	Depth of Cut ap (mm)	Feed per Tooth (mm/t.)						
				Cutting Edge Diameter DC (mm)						
				32	40	50, 63, 80	100, 125			
N	Aluminium Alloy	Si<5%	GL	≤0.25 DC	≤ 5	≤ 0.35	≤ 0.4	≤ 0.4	≤ 0.4	
					≤ 10	≤ 0.3	≤ 0.35	≤ 0.35	≤ 0.35	
					≤ 15	≤ 0.25	≤ 0.3	≤ 0.3	≤ 0.3	
					≤ 20	≤ 0.2	≤ 0.25	≤ 0.25	≤ 0.25	
				≤0.5 DC	≤ 5	≤ 0.35	≤ 0.35	≤ 0.4	≤ 0.4	
					≤ 10	≤ 0.3	≤ 0.3	≤ 0.35	≤ 0.35	
					≤ 15	≤ 0.25	≤ 0.25	≤ 0.3	≤ 0.3	
					≤ 20	≤ 0.2	≤ 0.2	≤ 0.25	≤ 0.25	
				≤0.75 DC	≤ 5	≤ 0.3	≤ 0.3	≤ 0.35	≤ 0.35	
					≤ 10	≤ 0.25	≤ 0.25	≤ 0.3	≤ 0.3	
					≤ 15	≤ 0.2	≤ 0.2	≤ 0.25	≤ 0.25	
					≤ 20	≤ 0.15	≤ 0.15	≤ 0.2	≤ 0.2	
			DC (Slot)	≤ 5	≤ 0.25	≤ 0.3	≤ 0.35	≤ 0.35		
				≤ 10	≤ 0.2	≤ 0.25	≤ 0.3	≤ 0.3		
				≤ 15	≤ 0.15	≤ 0.2	≤ 0.25	≤ 0.25		
				≤ 20	≤ 0.1	≤ 0.15	≤ 0.2	≤ 0.2		
			5%≤Si≤10% Si>10%	GL	≤0.25 DC	≤ 5	≤ 0.35	≤ 0.4	≤ 0.4	≤ 0.4
						≤ 10	≤ 0.3	≤ 0.35	≤ 0.35	≤ 0.35
						≤ 15	≤ 0.25	≤ 0.3	≤ 0.3	≤ 0.3
						≤ 20	≤ 0.2	≤ 0.25	≤ 0.25	≤ 0.25
					≤0.5 DC	≤ 5	≤ 0.35	≤ 0.35	≤ 0.4	≤ 0.4
						≤ 10	≤ 0.3	≤ 0.3	≤ 0.35	≤ 0.35
						≤ 15	≤ 0.25	≤ 0.25	≤ 0.3	≤ 0.3
						≤ 20	≤ 0.2	≤ 0.2	≤ 0.25	≤ 0.25
		≤0.75 DC			≤ 5	≤ 0.3	≤ 0.3	≤ 0.35	≤ 0.35	
					≤ 10	≤ 0.25	≤ 0.25	≤ 0.3	≤ 0.3	
					≤ 15	≤ 0.2	≤ 0.2	≤ 0.25	≤ 0.25	
					≤ 20	≤ 0.15	≤ 0.15	≤ 0.2	≤ 0.2	
		DC (Slot)		≤ 5	≤ 0.25	≤ 0.3	≤ 0.35	≤ 0.35		
				≤ 10	≤ 0.2	≤ 0.25	≤ 0.3	≤ 0.3		
				≤ 15	≤ 0.15	≤ 0.2	≤ 0.25	≤ 0.25		
				≤ 20	≤ 0.1	≤ 0.15	≤ 0.2	≤ 0.2		

Note 1) The above cutting conditions are determined based on high workpiece and machine rigidity, where no vibration occurred. If vibrations occur make adjustments according to the machining conditions.

Note 2) Vibrations may occur in the following conditions:

- When using long tool overhang.
- When pocket machining corner radii.
- When the workpiece has poor clamping rigidity or when the machine rigidity or workpiece rigidity is low, vibrations can occur easily, if so, reduce cutting conditions such as width and depth of cut and feed per tooth.

ROTATING TOOLS

■ RAMPING/HELICAL MILLING

● RAMPING

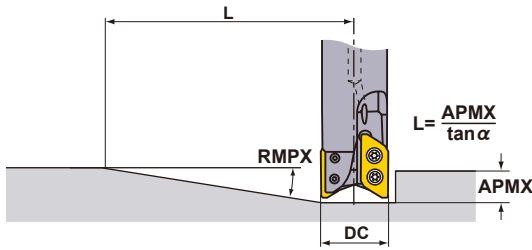

● HELICAL MILLING

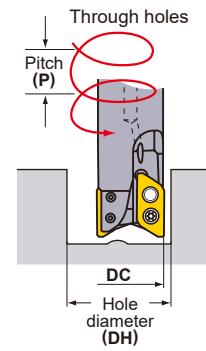

K

ROTATING TOOLS

RAMPING/HELICAL MILLING (ALUMINIUM ALLOY)

Type	DC (mm)	RE (mm)	Ramping	
			RMPX	L (mm) *1
A type	32	0.8 - 2.4	19°	61
		3, 3.2	18°	65
	40	0.8 - 2.4	14°	85
		3, 3.2	13°	91
	50	0.8 - 2.4	10°	120
		3, 3.2	9°	133
	63	0.8 - 2.4	8°	150
		3, 3.2	7°	172
80	0.8 - 2.4	6°	200	
	3, 3.2	5°	241	
100	0.8 - 2.4	4°	301	
	3, 3.2	4°	301	
125	0.8 - 2.4	3°	401	
	3, 3.2	3°	401	
B type	32	4, 5	18°	63
	40	4, 5	11°	105
	50	4, 5	8°	146
	63	4, 5	6°	195
	80	4, 5	4°	292
	100	4, 5	3°	390
125	4, 5	2°	585	

Type	DC (mm)	RE (mm)	Helical Milling	
			DH min. (mm)	P max. (mm)
A type	32	0.8 - 2.4	41	8
		3, 3.2	41	7
	40	0.8 - 2.4	57	10
		3, 3.2	57	9
	50	0.8 - 2.4	77	12
		3, 3.2	77	11
	63	0.8 - 2.4	103	13
		3, 3.2	103	12
80	0.8 - 2.4	137	14	
	3, 3.2	137	12	
100	0.8 - 2.4	177	14	
	3, 3.2	177	13	
125	0.8 - 2.4	227	15	
	3, 3.2	227	13	
B type	32	4	41	7
		5	41	6
	40	4	57	9
		5	57	8
	50	4	77	10
		5	77	9
	63	4	103	10
		5	103	10
	80	4	137	11
		5	137	10
	100	4	177	11
		5	177	10
125	4	227	11	
	5	227	11	

Note 1) The recommended ramping feed is 0.05 mm/t. or under.

Ramping, helical milling and drilling are not recommended for machining of steel and titanium alloys.

*1 L (Max. Depth of Cut = $15 / \tan \alpha$). Cutters' moving distance until depth of cut reaches APMX at a maximum ramping angle.

Maximum depth of cut A type is 21mm, B type is 20.4 mm.

*2 The maximum diameter when machining a blind hole with a flat face using a corner radius of 0.8 mm for A type and 4 mm for B type.

For other corner radii, use the formula below.

$$\{(cutting\ edge\ diameter\ DC) - (corner\ radius) - 0.3\} \times 2$$

*3 The minimum diameter when machining a blind hole with a flat face using a corner radius of 0.8 mm for A type and 4 mm for B type.

For other corner radii, use the formula below.

$$\{(cutting\ edge\ diameter\ DC) - (corner\ radius) - (Width\ of\ wiper\ edge\ BS) - 0.1\} \times 2$$

■ Max. Drilling Depth (Aluminium Alloy)

Type	Insert corner radius RE (mm)	Max. Drilling Depth (mm)
Type A	0.8 - 2.4	5
	3, 3.2	4.5
Type B	4	4
	5	3.5

AXD7000 can be effectively used for pocket machining without the need for a prepared hole.

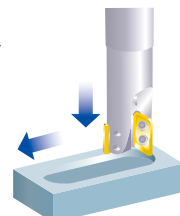

● HELICAL MILLING

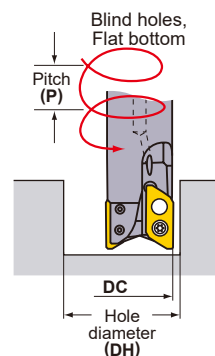

RAMPING/HELICAL MILLING (ALUMINIUM ALLOY)

Type	DC (mm)	RE (mm)	BS (mm)	Helical Milling (Blind Hole, Flat Bottom)			
				DH max. (mm) *2	P max. (mm)	DH min. (mm) *3	P max. (mm)
A type	32	0.8	2	61.9	20	58.3	20
		1.6	1.2	60.3	19	58.3	19
		2	0.8	59.5	18	58.3	18
		2.4	0.4	58.7	18	58.3	18
		3	0.8	57.5	17	56.2	17
	40	3.2	0.6	57.1	17	56.2	17
		0.8	2	77.9	20	74.3	20
		1.6	1.2	76.3	19	74.3	19
		2	0.8	75.5	18	74.3	18
		2.4	0.4	74.7	18	74.3	18
	50	3	0.8	73.5	17	72.2	17
		3.2	0.6	73.1	17	72.2	17
		0.8	2	97.5	20	94.1	20
		1.6	1.2	95.9	19	94.1	19
		2	0.8	95.1	18	94.1	18
	63	2.4	0.4	94.3	18	94.1	18
		3	0.8	93.1	17	92.1	17
		3.2	0.6	92.7	17	92.1	17
		0.8	2	123.5	20	120.1	19
		1.6	1.2	121.9	19	120.1	19
	80	2	0.8	121.1	18	120.1	18
		2.4	0.4	120.3	18	120.1	18
		3	0.8	119.1	17	118	16
		3.2	0.6	118.7	17	118	16
		0.8	2	157.5	19	154.1	18
	100	1.6	1.2	155.9	19	154.1	18
		2	0.8	155.1	18	154.1	18
		2.4	0.4	154.3	18	154.1	18
3		0.8	153.1	16	152	16	
3.2		0.6	152.7	16	152	16	
125	0.8	2	197.5	18	194.1	18	
	1.6	1.2	195.9	18	194.1	18	
	2	0.8	195.1	18	194.1	18	
	2.4	0.4	194.3	18	194.1	18	
	3	0.8	193.1	15	192	15	
B type	32	4	0.9	55.5	16	54	16
		5	0.4	53.5	15	53.1	15
	40	4	0.9	71.5	16	70	16
		5	0.4	69.5	15	69	14
	50	4	0.9	91.1	15	89.8	15
		5	0.4	89.1	14	88.9	14
	63	4	0.9	117.1	14	115.8	14
5		0.4	115.1	13	114.9	13	
80	4	0.9	151.1	14	149.8	13	
	5	0.4	149.1	12	148.9	12	
100	4	0.9	191.1	13	189.8	13	
	5	0.4	189.1	12	188.8	12	
125	4	0.9	241.1	13	239.8	13	
	5	0.4	239.1	12	238.8	12	

Note 1) The recommended ramping feed is 0.05mm/t. or under.

*1 L (Max. Depth of Cut = 15 / tan α). Cutters' moving distance until depth of cut reaches APMX at a maximum ramping angle.
Maximum depth of cut A type is 21 mm, B type is 20.4 mm.

*2 The maximum diameter when machining a blind hole with a flat face using a corner radius of 0.8 mm for A type and 4 mm for B type.
Other than that, find with the below formula.

$$\{(\text{cutting edge DC}) - (\text{corner radius}) - 0.3\} \times 2$$

*3 The minimum diameter when machining a blind hole with a flat face using a corner radius of 0.8 mm for A type and 4 mm for B type.
Other than that, find by using the formula below.

$$\{(\text{cutting edge diameter DC}) - (\text{corner radius}) - (\text{Width of wiper edge BS}) - 0.1\} \times 2$$

ROTATING TOOLS

MULTI FUNCTIONAL MILLING



AQX

- P
M
K
N
S
H

K

ROTATING TOOLS



Fig.1



Number of Teeth : 4

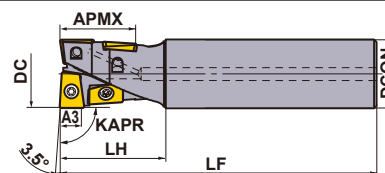
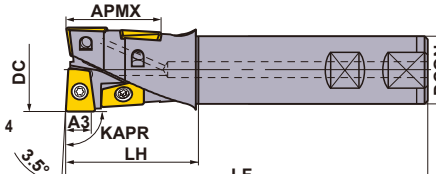

Fig.2



Number of Teeth : 4



STANDARD EDGE TYPE

KAPR : 90°

Type	Order Number	Stock	Coolant Hole	Dimensions (mm)						Type (Fig.)	*3		
				DC	LF	DCON	LH	A3 ^{*1}	APMX ^{*2}		Clamp Screw	Wrench	Insert
Standard	AQXR164SA16S	●	○	16	120	16	30	4.5	17.6	1	TS2A	①TKY06F	QOG/MT0830R-G1/M2
	AQXR164SN16S	★	—	16	120	16	30	4.5	17.6	1	TS2A	①TKY06F	
	AQXR174SA16S	●	○	17	120	16	30	4.5	17.6	1	TS2A	①TKY06F	
	AQXR174SN16S	★	—	17	120	16	30	4.5	17.6	1	TS2A	①TKY06F	
	AQXR204SA20S	●	○	20	130	20	35	6	22	1	TS25	①TKY08F	QOG/MT1035R-G1/M2
	AQXR204SN20S	★	—	20	130	20	35	6	22	1	TS25	①TKY08F	
	AQXR214SA20S	●	○	21	130	20	35	6	22	1	TS25	①TKY08F	
	AQXR214SN20S	★	—	21	130	20	35	6	22	1	TS25	①TKY08F	
	AQXR254SA25S	●	○	25	140	25	40	7.5	27.5	1	TS33	②TKY08D	QOG/MT1342R-G1/M2
	AQXR254SN25S	★	—	25	140	25	40	7.5	27.5	1	TS33	②TKY08D	
	AQXR264SA25S	●	○	26	140	25	40	7.5	27.5	1	TS33	②TKY08D	
	AQXR264SN25S	★	—	26	140	25	40	7.5	27.5	1	TS33	②TKY08D	
	AQXR324SA32S	●	○	32	150	32	50	9.5	35.2	1	TS407	②TKY15D	QOG/MT1651R-G1/M2
	AQXR324SN32S	★	—	32	150	32	50	9.5	35.2	1	TS407	②TKY15D	
	AQXR334SA32S	●	○	33	150	32	50	9.5	35.2	1	TS407	②TKY15D	
	AQXR334SN32S	★	—	33	150	32	50	9.5	35.2	1	TS407	②TKY15D	
	AQXR354SA32S	●	○	35	150	32	50	11	40	1	TS407	②TKY15D	QOG/MT1856R-G1/M2
	AQXR354SN32S	★	—	35	150	32	50	11	40	1	TS407	②TKY15D	
	AQXR404SA32S	●	○	40	160	32	60	12	44	1	TS55	②TKY25D	QOG/MT2062R-G1/M2
	AQXR404SN32S	★	—	40	160	32	60	12	44	1	TS55	②TKY25D	
AQXR504WA40S	●	○	50	170	40	70	15	55	2	TS6S	③TKY30T	QOG/MT2576R-G1/M2	
AQXR504SA42S	★	○	50	170	42	70	15	55	1	TS6S	③TKY30T		
AQXR504SN42S	★	—	50	170	42	70	15	55	1	TS6S	③TKY30T		
AQXR164SA16L	●	○	16	175	16	50	4.5	17.6	1	TS2A	①TKY06F		QOG/MT0830R-G1/M2
AQXR164SN16L	★	—	16	175	16	50	4.5	17.6	1	TS2A	①TKY06F		
AQXR174SA16L	●	○	17	175	16	30	4.5	17.6	1	TS2A	①TKY06F		
AQXR174SN16L	★	—	17	175	16	30	4.5	17.6	1	TS2A	①TKY06F		
AQXR204SA20L	●	○	20	185	20	60	6	22	1	TS25	①TKY08F	QOG/MT1035R-G1/M2	
AQXR204SN20L	★	—	20	185	20	60	6	22	1	TS25	①TKY08F		
AQXR214SA20L	●	○	21	185	20	35	6	22	1	TS25	①TKY08F		
AQXR214SN20L	★	—	21	185	20	35	6	22	1	TS25	①TKY08F		
AQXR254SA25L	●	○	25	220	25	75	7.5	27.5	1	TS33	②TKY08D	QOG/MT1342R-G1/M2	
AQXR254SN25L	★	—	25	220	25	75	7.5	27.5	1	TS33	②TKY08D		
AQXR264SA25L	●	○	26	220	25	40	7.5	27.5	1	TS33	②TKY08D		
AQXR264SN25L	★	—	26	220	25	40	7.5	27.5	1	TS33	②TKY08D		
AQXR324SA32L	●	○	32	230	32	90	9.5	35.2	1	TS407	②TKY15D	QOG/MT1651R-G1/M2	
AQXR324SN32L	★	—	32	230	32	90	9.5	35.2	1	TS407	②TKY15D		
AQXR334SA32L	●	○	33	230	32	50	9.5	35.2	1	TS407	②TKY15D		
AQXR334SN32L	★	—	33	230	32	50	9.5	35.2	1	TS407	②TKY15D		
AQXR354SA32L	●	○	35	230	32	50	11	40	1	TS407	②TKY15D	QOG/MT1856R-G1/M2	
AQXR354SN32L	★	—	35	230	32	50	11	40	1	TS407	②TKY15D		
AQXR404SA32L	●	○	40	240	32	60	12	44	1	TS55	②TKY25D	QOG/MT2062R-G1/M2	
AQXR404SN32L	★	—	40	240	32	60	12	44	1	TS55	②TKY25D		
AQXR504WA40L	●	○	50	250	40	70	15	55	2	TS6S	③TKY30T	QOG/MT2576R-G1/M2	
AQXR504SA42L	★	○	50	250	42	70	15	55	1	TS6S	③TKY30T		
AQXR504SN42L	★	—	50	250	42	70	15	55	1	TS6S	③TKY30T		

*1 Dimension A3 represents the depth of cut when the cutting edge consists of 2 inserts.

*2 APMX: Maximum depth of cut.

*3 Clamp Torque (N · m) : TS2A=0.6, TS25=1.0, TS33=1.0, TS407=3.5, TS55=7.5, TS6S=10.0

● : Inventory maintained. ★ : Inventory maintained in Japan.



Fig.1



Number of Teeth : 2

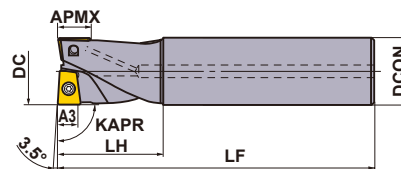
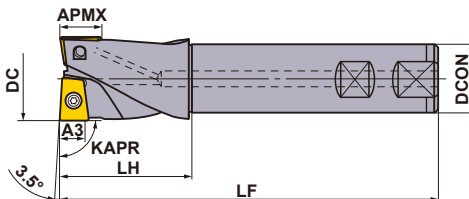

Fig.2



Number of Teeth : 2



SHORT EDGE TYPE

KAPR :90°

Right hand tool holder only.

Type	Order Number	Stock	Coolant Hole	Dimensions (mm)						Type (Fig.)	*3		
				DC	LF	DCON	LH	A3*1	APMX*2		Clamp Screw	Wrench	Insert
Standard	AQXR162SA16S	●	○	16	120	16	30	4.5	7.4	1	TS2A	①TKY06F	QOG/MT0830R-G1/M2
	AQXR162SN16S	★	—	16	120	16	30	4.5	7.4	1	TS2A	①TKY06F	
	AQXR172SA16S	●	○	17	120	16	30	4.5	7.4	1	TS2A	①TKY06F	
	AQXR172SN16S	★	—	17	120	16	30	4.5	7.4	1	TS2A	①TKY06F	
	AQXR202SA20S	●	○	20	130	20	35	6	9.2	1	TS25	①TKY08F	QOG/MT1035R-G1/M2
	AQXR202SN20S	★	—	20	130	20	35	6	9.2	1	TS25	①TKY08F	
	AQXR212SA20S	●	○	21	130	20	35	6	9.2	1	TS25	①TKY08F	
	AQXR212SN20S	★	—	21	130	20	35	6	9.2	1	TS25	①TKY08F	
	AQXR252SA25S	●	○	25	140	25	40	7.5	11.5	1	TS33	②TKY08D	QOG/MT1342R-G1/M2
	AQXR252SN25S	★	—	25	140	25	40	7.5	11.5	1	TS33	②TKY08D	
	AQXR262SA25S	●	○	26	140	25	40	7.5	11.5	1	TS33	②TKY08D	
	AQXR262SN25S	★	—	26	140	25	40	7.5	11.5	1	TS33	②TKY08D	
	AQXR322SA32S	●	○	32	150	32	50	9.5	14.5	1	TS407	②TKY15D	QOG/MT1651R-G1/M2
	AQXR322SN32S	★	—	32	150	32	50	9.5	14.5	1	TS407	②TKY15D	
	AQXR332SA32S	●	○	33	150	32	50	9.5	14.5	1	TS407	②TKY15D	
	AQXR332SN32S	★	—	33	150	32	50	9.5	14.5	1	TS407	②TKY15D	
	AQXR352SA32S	●	○	35	150	32	50	11	16	1	TS407	②TKY15D	QOG/MT1856R-G1/M2
	AQXR352SN32S	★	—	35	150	32	50	11	16	1	TS407	②TKY15D	
	AQXR402SA32S	●	○	40	160	32	60	12	18	1	TS55	②TKY25D	QOG/MT2062R-G1/M2
	AQXR402SN32S	★	—	40	160	32	60	12	18	1	TS55	②TKY25D	
AQXR502WA40S	●	○	50	170	40	70	15	23	2	TS6S	③TKY30T	QOG/MT2576R-G1/M2	
AQXR502SA42S	★	○	50	170	42	70	15	23	1	TS6S	③TKY30T		
AQXR502SN42S	★	—	50	170	42	70	15	23	1	TS6S	③TKY30T		
AQXR502SN42S	★	—	50	170	42	70	15	23	1	TS6S	③TKY30T		
Long	AQXR162SA16L	●	○	16	175	16	50	4.5	7.4	1	TS2A	①TKY06F	QOG/MT0830R-G1/M2
	AQXR162SN16L	★	—	16	175	16	50	4.5	7.4	1	TS2A	①TKY06F	
	AQXR172SA16L	●	○	17	175	16	30	4.5	7.4	1	TS2A	①TKY06F	
	AQXR172SN16L	★	—	17	175	16	30	4.5	7.4	1	TS2A	①TKY06F	
	AQXR202SA20L	●	○	20	185	20	60	6	9.2	1	TS25	①TKY08F	QOG/MT1035R-G1/M2
	AQXR202SN20L	★	—	20	185	20	60	6	9.2	1	TS25	①TKY08F	
	AQXR212SA20L	●	○	21	185	20	35	6	9.2	1	TS25	①TKY08F	
	AQXR212SN20L	★	—	21	185	20	35	6	9.2	1	TS25	①TKY08F	
	AQXR252SA25L	●	○	25	220	25	75	7.5	11.5	1	TS33	②TKY08D	QOG/MT1342R-G1/M2
	AQXR252SN25L	★	—	25	220	25	75	7.5	11.5	1	TS33	②TKY08D	
	AQXR262SA25L	●	○	26	220	25	40	7.5	11.5	1	TS33	②TKY08D	
	AQXR262SN25L	★	—	26	220	25	40	7.5	11.5	1	TS33	②TKY08D	
	AQXR322SA32L	●	○	32	230	32	90	9.5	14.5	1	TS407	②TKY15D	QOG/MT1651R-G1/M2
	AQXR322SN32L	★	—	32	230	32	90	9.5	14.5	1	TS407	②TKY15D	
	AQXR332SA32L	●	○	33	230	32	50	9.5	14.5	1	TS407	②TKY15D	
	AQXR332SN32L	★	—	33	230	32	50	9.5	14.5	1	TS407	②TKY15D	
	AQXR352SA32L	●	○	35	230	32	50	11	16	1	TS407	②TKY15D	QOG/MT1856R-G1/M2
	AQXR352SN32L	★	—	35	230	32	50	11	16	1	TS407	②TKY15D	
	AQXR402SA32L	●	○	40	240	32	60	12	18	1	TS55	②TKY25D	QOG/MT2062R-G1/M2
	AQXR402SN32L	★	—	40	240	32	60	12	18	1	TS55	②TKY25D	
AQXR502WA40L	●	○	50	250	40	70	15	23	2	TS6S	③TKY30T	QOG/MT2576R-G1/M2	
AQXR502SA42L	★	○	50	250	42	70	15	23	1	TS6S	③TKY30T		
AQXR502SN42L	★	—	50	250	42	70	15	23	1	TS6S	③TKY30T		
AQXR502SN42L	★	—	50	250	42	70	15	23	1	TS6S	③TKY30T		

*1 Dimension A3 represents the depth of cut when the cutting edge consists of 2 inserts.

*2 APMX: Maximum depth of cut.

*3 Clamp Torque (N · m) : TS2A=0.6, TS25=1.0, TS33=1.0, TS407=3.5, TS55=7.5, TS6S=10.0

ROTATING TOOLS

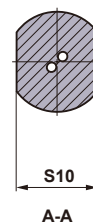
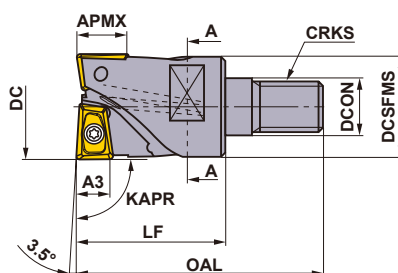
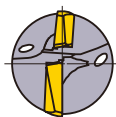

ROTATING TOOLS

K

SCREW-IN TYPE

KAPR :90°

Right hand tool holder only.

Order Number	Stock Coolant Hole	Dimensions (mm)										*4 WT (kg)	*3 		
		DC	DCON	DCSFMS	OAL	LF	S10	CRKS	A3*1	APMX*2	Clamp Screw				
AQXR162M08A30	● ○	16	8.5	14.7	48	30	10	M8	4.5	7.4	0.1	TS2A	①TKY06F	QO○T0830R-○○	
AQXR172M08A30	● ○	17	8.5	14.5	48	30	10	M8	4.5	7.4	0.1	TS2A	①TKY06F		
AQXR202M10A30	● ○	20	10.5	18.6	49	30	14	M10	6	9.2	0.2	TS25	①TKY08F	QO○T1035R-○○	
AQXR212M10A30	● ○	21	10.5	18.5	49	30	14	M10	6	9.2	0.2	TS25	①TKY08F		
AQXR252M12A35	● ○	25	12.5	23.5	57	35	19	M12	7.5	11.5	0.2	TS33	②TKY08D	QO○T1342R-○○	
AQXR262M12A35	● ○	26	12.5	23.5	57	35	19	M12	7.5	11.5	0.2	TS33	②TKY08D		
AQXR322M16A40	● ○	32	17	28.5	63	40	24	M16	9.5	14.5	0.3	TS407	②TKY15D	QO○T1651R-○○	
AQXR332M16A40	● ○	33	17	28.5	63	40	24	M16	9.5	14.5	0.3	TS407	②TKY15D		
AQXR352M16A40	● ○	35	17	28.5	63	40	24	M16	11	16	0.3	TS407	②TKY15D	QO○T1856R-○○	
AQXR402M16A45	● ○	40	17	28.5	68	45	24	M16	12	18	0.3	TS55	②TKY25D		

Note 1) For screw-in type arbors, refer to page K244.

*1 Dimension A3 represents the depth of cut when the cutting edge consists of 2 inserts.

*2 APMX: Maximum depth of cut.

*3 Clamp Torque (N · m) : TS2A=0.6, TS25=1.0, TS33=1.0, TS407=3.5, TS55=7.5

*4 WT : Tool Weight

ROTATING TOOLS

RECOMMENDED CUTTING CONDITIONS

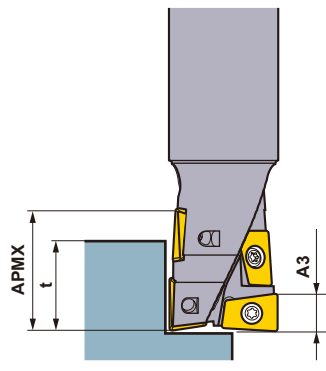

● A3 is the depth of cut for the full dual insert portion at the end of the cutting edge.
 ● Beyond the range of A3 where overlapping occurs, there is an area where the cutting edge becomes a single insert, not forming full dual insert configuration. Therefore, please pay special attention to the relationship between depth of cut and feed.
 ● In general, the edge at the border of cut tends to suffer from damage. At large depths of cut, applying the following depth of cut (t), at which the edge is full dual insert at the border of cut is recommended to prevent damage to the cutting edge.

Tool diameter	Recommended depth of cut t (mm)
φ 16,17	12 – 14
φ 20,21	14 – 17
φ 25,26	17 – 22
φ 32,33	22 – 28
φ 35	25 – 32
φ 40	28 – 35
φ 50	35 – 45

* Figures for A3 and APMX are shown in the standard holder tables on the previous pages.

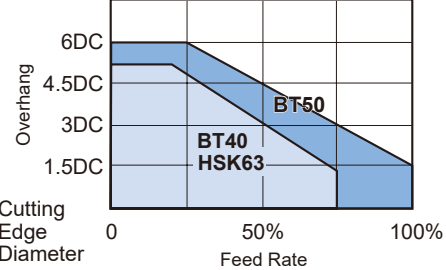

* DC=Cutting Edge Diameter

● Chatter vibration and other problems tend to occur at operations where overhang length is large and/or machine rigidity is low, resulting in unstable machining.
 ● Please reduce feed accordingly, using the above chart as a guideline.

K ROTATING TOOLS

CUTTING CONDITIONS FOR SHOULDER MILLING

Work Material	No.	Hardness	φ16, 17			φ20, 21			φ25, 26		
			ap (mm)	ae (mm)	fr (mm/rev)	ap (mm)	ae (mm)	fr (mm/rev)	ap (mm)	ae (mm)	fr (mm/rev)
P Mild Steel	1	≤180HB	≤4.5	≤8	0.25	≤6	≤10	0.3	≤7.5	≤12.5	0.35
			4.5–12	≤5	0.16	6–14	≤7	0.25	7.5–17	≤8	0.28
			12–17	≤3	0.1	14–22	≤4	0.18	17–27	≤5	0.2
Carbon Steel Alloy Steel	2	180–350HB	≤4.5	≤8	0.2	≤6	≤10	0.25	≤7.5	≤12.5	0.3
			4.5–12	≤4	0.14	6–14	≤6	0.2	7.5–17	≤7	0.25
			12–17	≤2	0.08	14–22	≤3	0.16	17–27	≤4	0.18
M Stainless Steel	1,2,3,4	–	≤4.5	≤8	0.2	≤6	≤10	0.25	≤7.5	≤12.5	0.3
			4.5–12	≤4	0.14	6–14	≤6	0.2	7.5–17	≤7	0.25
			12–17	≤2	0.08	14–22	≤3	0.16	17–27	≤4	0.18
K Cast Iron	1,2	–	≤4.5	≤8	0.25	≤6	≤10	0.3	≤7.5	≤12.5	0.35
			4.5–12	≤5	0.16	6–14	≤7	0.25	7.5–17	≤8	0.28
			12–17	≤3	0.1	14–22	≤4	0.18	17–27	≤5	0.2
N Aluminium Alloy	1,2,3	–	≤4.5	≤11	0.3	≤6	≤14	0.35	≤7.5	≤12.5	0.4
			4.5–12	≤8	0.21	6–14	≤10	0.3	7.5–17	≤7	0.33
			12–17	≤5	0.15	14–22	≤6	0.23	17–27	≤4	0.25
S Titanium Alloy	1	–	≤4.5	≤8	0.14	≤6	≤10	0.18	≤7.5	≤17.5	0.21
			4.5–12	≤4	0.1	6–14	≤6	0.14	7.5–17	≤12.5	0.18
			12–17	≤2	0.06	14–22	≤3	0.11	17–27	≤7.5	0.13
H Hardened Steel	1	40–55HRC	≤4.5	≤5	0.16	≤6	≤6	0.2	≤7.5	≤7	0.22
			4.5–12	≤3	0.1	6–14	≤4	0.16	7.5–17	≤4	0.18
			12–17	≤1	0.06	14–22	≤2	0.12	17–27	≤2	0.14

Work Material	No.	Hardness	φ32, 33			φ35			φ40			φ50		
			ap (mm)	ae (mm)	fr (mm/rev)	ap (mm)	ae (mm)	fr (mm/rev)	ap (mm)	ae (mm)	fr (mm/rev)	ap (mm)	ae (mm)	fr (mm/rev)
P Mild Steel	1	≤180HB	≤9.5	≤16	0.4	≤11	≤17.5	0.45	≤12	≤20	0.5	≤15	≤25	0.6
			9.5–22	≤11	0.32	11–25	≤12	0.35	12–28	≤13	0.4	15–35	≤16	0.5
			22–35	≤6	0.25	25–40	≤6.5	0.28	28–44	≤7	0.3	35–55	≤10	0.35
Carbon Steel Alloy Steel	2	180–350HB	≤9.5	≤16	0.35	≤11	≤17.5	0.37	≤12	≤20	0.4	≤15	≤25	0.5
			9.5–22	≤10	0.28	11–25	≤11	0.3	12–28	≤12	0.32	15–35	≤14	0.4
			22–35	≤5	0.2	25–40	≤5.5	0.22	28–44	≤6	0.25	35–55	≤8	0.3
M Stainless Steel	1,2,3,4	–	≤9.5	≤16	0.35	≤11	≤17.5	0.37	≤12	≤20	0.4	≤15	≤25	0.5
			9.5–22	≤10	0.28	11–25	≤12	0.3	12–28	≤12	0.32	15–35	≤14	0.4
			22–35	≤5	0.2	25–40	≤6.5	0.22	28–44	≤6	0.25	35–55	≤8	0.3
K Cast Iron	1,2	–	≤9.5	≤16	0.4	≤11	≤17.5	0.45	≤12	≤20	0.5	≤15	≤25	0.6
			9.5–22	≤11	0.32	11–25	≤12	0.35	12–28	≤13	0.4	15–35	≤16	0.5
			22–35	≤6	0.25	25–40	≤6.5	0.28	28–44	≤7	0.3	35–55	≤10	0.35
N Aluminium Alloy	1,2,3	–	≤9.5	≤16	0.45	≤11	≤17.5	0.5	≤12	≤20	0.55	≤15	≤25	0.65
			9.5–22	≤10	0.37	11–25	≤12	0.4	12–28	≤12	0.45	15–35	≤14	0.55
			22–35	≤5	0.3	25–40	≤6.5	0.32	28–44	≤6	0.35	35–55	≤8	0.4
S Titanium Alloy	1	–	≤9.5	≤23	0.25	≤11	≤24.5	0.26	≤12	≤28	0.28	≤15	≤35	0.35
			9.5–22	≤16	0.2	11–25	≤17.5	0.21	12–28	≤20	0.22	15–35	≤25	0.28
			22–35	≤10	0.14	25–40	≤10.5	0.15	28–44	≤12	0.18	35–55	≤15	0.21
H Hardened Steel	1	40–55HRC	≤9.5	≤8	0.25	≤11	≤9	0.28	≤12	≤10	0.3	≤15	≤14	0.35
			9.5–22	≤5	0.2	11–25	≤5.5	0.22	12–28	≤6	0.24	15–35	≤8	0.3
			22–35	≤2	0.16	25–40	≤2	0.17	28–44	≤2	0.18	35–55	≤4	0.22

Note 1) Please pay special attention on the depth of cut when using the short edge type.
 Note 2) When using the G1 breaker (VP15TF), please reduce the feed rate by 20%.
 Note 3) For the details of No., please refer to the cutting speed on page K175.

CUTTING CONDITIONS FOR SLOT MILLING

Work Material	No.	Hardness	φ16, 17		φ20, 21		φ25, 26	
			ap (mm)	fr (mm/rev)	ap (mm)	fr (mm/rev)	ap (mm)	fr (mm/rev)
P Mild Steel	1	≤180HB	≤4.5	0.16	≤6	0.18	≤7.5	0.2
			4.5-12	0.1	6-14	0.14	7.5-17	0.16
			12-17	0.07	14-22	0.1	17-27	0.12
Carbon Steel Alloy Steel	2	180-350HB	≤4.5	0.14	≤6	0.16	≤7.5	0.18
			4.5-12	0.09	6-14	0.12	7.5-17	0.14
			12-17	0.05	14-22	0.1	17-27	0.1
M Stainless Steel	1,2,3,4	-	≤4.5	0.14	≤6	0.16	≤7.5	0.18
			4.5-12	0.09	6-14	0.12	7.5-17	0.14
			12-17	0.05	14-22	0.1	17-27	0.1
K Gray Cast Iron	1	≤350MPa	≤4.5	0.16	≤6	0.18	≤7.5	0.2
			4.5-12	0.1	6-14	0.14	7.5-17	0.16
			12-17	0.07	14-22	0.1	17-27	0.12
N Aluminium Alloy	1,2,3	-	≤4.5	0.18	≤6	0.2	≤7.5	0.22
			4.5-12	0.12	6-14	0.16	7.5-17	0.18
			12-17	0.09	14-22	0.12	17-27	0.14
S Titanium Alloy	1	-	≤4.5	0.1	≤6	0.12	≤7.5	0.15
			4.5-12	0.05	6-14	0.08	7.5-17	0.1
			12-17	0.03	14-22	0.05	17-27	0.08
H Hardened Steel	1	40-55HRC	≤4.5	0.1	≤6	0.12	≤7.5	0.14
			4.5-12	0.07	6-14	0.1	7.5-17	0.12
			-	-	-	-	-	-

Work Material	No.	Hardness	φ32, 33		φ35		φ40		φ50	
			ap (mm)	fr (mm/rev)	ap (mm)	fr (mm/rev)	ap (mm)	fr (mm/rev)	ap (mm)	fr (mm/rev)
P Mild Steel	1	≤180HB	≤9.5	0.25	≤11	0.27	≤12	0.3	≤15	0.35
			9.5-22	0.2	11-25	0.22	12-28	0.25	15-35	0.3
			22-35	0.14	25-40	0.16	28-44	0.18	35-55	0.22
Carbon Steel Alloy Steel	2	180-350HB	≤9.5	0.2	≤11	0.22	≤12	0.25	≤15	0.3
			9.5-22	0.16	11-25	0.18	12-28	0.2	15-35	0.25
			22-35	0.12	25-40	0.13	28-44	0.14	35-55	0.16
M Stainless Steel	1,2,3,4	-	≤9.5	0.2	≤11	0.22	≤12	0.25	≤15	0.3
			9.5-22	0.16	11-25	0.18	12-28	0.2	15-35	0.25
			22-35	0.12	25-40	0.13	28-44	0.14	35-55	0.16
K Gray Cast Iron	1	≤350MPa	≤9.5	0.25	≤11	0.27	≤12	0.3	≤15	0.35
			9.5-22	0.2	11-25	0.22	12-28	0.25	15-35	0.3
			22-35	0.14	25-40	0.16	28-44	0.18	35-55	0.22
N Aluminium Alloy	1,2,3	-	≤9.5	0.27	≤11	0.3	≤12	0.32	≤15	0.37
			9.5-22	0.22	11-25	0.25	12-28	0.27	15-35	0.32
			22-35	0.16	25-40	0.18	28-44	0.2	35-55	0.25
S Titanium Alloy	1	-	≤9.5	0.18	≤11	0.2	≤12	0.23	≤15	0.25
			9.5-22	0.12	11-25	0.15	12-28	0.2	15-35	0.23
			22-35	0.1	25-40	0.12	28-44	0.15	35-55	0.18
H Hardened Steel	1	40-55HRC	≤9.5	0.16	≤11	0.17	≤12	0.18	≤15	0.22
			9.5-22	0.12	11-25	0.13	12-28	0.14	15-35	0.16
			-	-	-	-	-	-	-	-

Note 1) Please pay special attention on the depth of cut when using the short edge type.

Note 2) When using the G1 breaker (VP15TF), please reduce the feed rate by 20%.

Note 3) For the details of No., please refer to the cutting speed on page K175.

RECOMMENDED CUTTING CONDITIONS

FOR HELICAL CUTTING

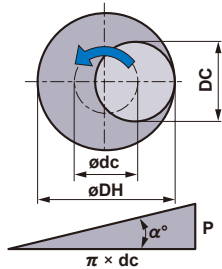
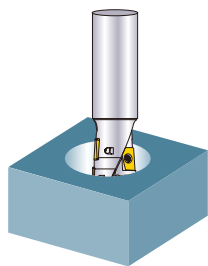

- How to derive a locus of the centre of the tool.
- Depth of cut per pass.
- Min. machined hole diameter for helical cutting : 1.2DC
Max. machined hole diameter for helical cutting : 1.8DC
- For chip discharge, please always apply air blow.
(When machining aluminium, please use coolant.)
- When using G1 breaker (VP15TF), please reduce the feed rate by 20%.

$$\varnothing dc = \varnothing DH - DC$$

Locus of the centre of the tool Desired hole diameter Cutting edge diameter

$$P = \pi \times dc \times \tan \alpha^\circ$$

(Note) $\alpha^\circ \leq 3^\circ$

ROTATING TOOLS

Work Material	No.	Hardness	ø16, 17				ø20, 21				ø25, 26			
			DH (mm)	APMX (mm)	fr (mm/rev)	P (mm/pass)	DH (mm)	APMX (mm)	fr (mm/rev)	P (mm/pass)	DH (mm)	APMX (mm)	fr (mm/rev)	P (mm/pass)
P Mild Steel	1	≤180HB	20	8	0.16	0.44	24	10	0.18	0.44	30	12.5	0.2	0.55
			25	12	0.14	0.99	30	15	0.16	1.1	38	19	0.18	1.43
			29	16	0.12	1.43	36	20	0.14	1.76	45	25	0.16	2.2
Carbon Steel Alloy Steel	2	180–350HB	20	8	0.14	0.33	24	10	0.16	0.33	30	12.5	0.18	0.41
			25	12	0.12	0.74	30	15	0.14	0.82	38	19	0.16	1.07
			29	16	0.1	1.07	36	20	0.12	1.32	45	25	0.14	1.65
M Stainless Steel	1,2,3,4	—	20	3	0.14	0.22	24	4	0.16	0.22	30	5	0.18	0.27
			25	5	0.12	0.49	30	7	0.14	0.55	38	9	0.16	0.71
			29	8	0.1	0.71	36	10	0.12	0.88	45	12.5	0.14	1.1
K Gray Cast Iron	1	≤350MPa	20	10	0.16	0.55	24	14	0.18	0.55	30	18	0.2	0.69
			25	13	0.14	1.23	30	17	0.16	1.37	38	21	0.18	1.78
			29	16	0.12	1.78	36	20	0.14	2.19	45	25	0.16	2.74
N Aluminium Alloy	1,2,3	—	20	10	0.18	0.44	24	14	0.2	0.44	30	18	0.22	0.55
			25	13	0.16	0.99	30	17	0.18	1.1	38	21	0.2	1.43
			29	16	0.14	1.43	36	20	0.16	1.76	45	25	0.18	2.2
S Titanium Alloy	1	—	20	3	0.1	0.22	24	4	0.11	0.22	30	5	0.13	0.27
			25	5	0.08	0.49	30	7	0.1	0.55	38	9	0.11	0.71
			29	8	0.07	0.71	36	10	0.08	0.88	45	12.5	0.1	1.1
H Hardened Steel	1	40–55HRC	20	3	0.1	0.22	24	4	0.12	0.22	30	5	0.14	0.27
			25	5	0.08	0.49	30	7	0.1	0.55	38	9	0.12	0.71
			29	8	0.06	0.71	36	10	0.08	0.88	45	12.5	0.1	1.1

Work Material	No.	Hardness	ø32, 33				ø35				ø40				ø50			
			DH (mm)	APMX (mm)	fr (mm/rev)	P (mm/pass)	DH (mm)	APMX (mm)	fr (mm/rev)	P (mm/pass)	DH (mm)	APMX (mm)	fr (mm/rev)	P (mm/pass)	DH (mm)	APMX (mm)	fr (mm/rev)	P (mm/pass)
P Mild Steel	1	≤180HB	38	16	0.25	0.66	42	18	0.28	0.77	48	20	0.3	0.88	60	25	0.35	1.1
			48	24	0.22	1.76	53	27	0.24	1.97	60	30	0.26	2.19	75	38	0.3	2.74
			58	32	0.2	2.85	63	35	0.21	3.07	72	40	0.22	3.51	90	50	0.26	4.39
Carbon Steel Alloy Steel	2	180–350HB	38	16	0.2	0.49	42	18	0.22	0.58	48	20	0.25	0.66	60	25	0.28	0.82
			48	24	0.18	1.32	53	27	0.2	1.48	60	30	0.22	1.65	75	38	0.26	2.06
			58	32	0.16	2.14	63	35	0.18	2.3	72	40	0.2	2.63	90	50	0.24	3.29
M Stainless Steel	1,2,3,4	—	38	6	0.2	0.33	42	7	0.22	0.38	48	8	0.25	0.44	60	10	0.28	0.55
			48	11	0.18	0.88	53	13	0.2	0.99	60	14	0.22	1.1	75	18	0.26	1.37
			58	16	0.16	1.43	63	18	0.18	1.53	72	20	0.2	1.75	90	25	0.27	2.19
K Gray Cast Iron	1	≤350MPa	38	22	0.25	0.82	42	25	0.28	0.95	48	28	0.3	1.1	60	35	0.35	1.37
			48	27	0.22	2.19	53	30	0.24	2.47	60	34	0.26	2.74	75	43	0.3	3.43
			58	32	0.2	3.57	63	35	0.21	3.84	72	40	0.22	4.39	90	50	0.26	5.49
N Aluminium Alloy	1,2,3	—	38	22	0.27	0.66	42	25	0.3	0.77	48	28	0.32	0.88	60	35	0.37	1.1
			48	27	0.24	1.76	53	30	0.26	1.97	60	34	0.28	2.19	75	43	0.32	2.74
			58	32	0.22	2.85	63	35	0.21	3.07	72	40	0.24	3.51	90	50	0.27	4.39
S Titanium Alloy	1	—	38	6	0.14	0.33	42	7	0.15	0.38	48	8	0.18	0.44	60	10	0.2	0.55
			48	11	0.13	0.88	53	13	0.14	0.99	60	14	0.15	1.1	75	18	0.18	1.37
			58	16	0.11	1.43	63	18	0.13	1.53	72	20	0.14	1.75	90	25	0.17	2.19
H Hardened Steel	1	40–55HRC	38	6	0.16	0.33	42	7	0.17	0.38	48	8	0.18	0.44	60	10	0.2	0.55
			48	11	0.14	0.88	53	13	0.15	0.99	60	14	0.16	1.1	75	18	0.18	1.37
			58	16	0.12	1.43	63	18	0.13	1.53	72	20	0.14	1.75	90	25	0.16	2.19

Note 1) Helical grooving is strongly recommended for machining tempered steel.
 Note 2) When using G1 breaker (VP15TF), please reduce the feed rate by 20%.
 Note 3) For the details please refer to the cutting speed on page K175.

■ FOR DRILLING AND PLUNGING

● Drilling

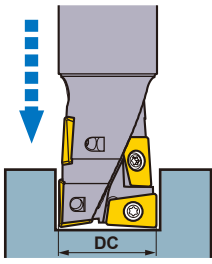

- The recommended drilling depth is less than 0.5DC.
- Use step feed when drilling (0.25–0.5mm) to ensure that the chips are effectively broken.
- Use internal or external coolant to ensure efficient chip disposal.
- The chips generated can dispel in any direction, ensure that adequate safety precautions are taken.

● Plunging

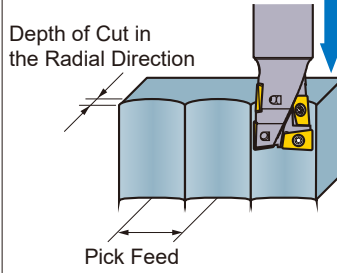

- The feed for plunging is the same as the feed for drilling.
- No step feed necessary.
- Please refer to the following table for the depth of cut for plunging operations.

Depth of Cut in the Radial Direction	≤ 0.4DC
Pick Feed	≤ 0.5DC

Work Material	No.	Hardness	φ16, 17		φ20, 21		φ25, 26		φ32, 33, 35		φ40		φ50	
			fr (mm/rev)	Step (mm)	fr (mm/rev)	Step (mm)	fr (mm/rev)	Step (mm)	fr (mm/rev)	Step (mm)	fr (mm/rev)	Step (mm)	fr (mm/rev)	Step (mm)
P Mild Steel	1	≤180HB	0.035	0.2	0.045	0.3	0.05	0.3	0.055	0.3	0.06	0.3	0.065	0.3
	Carbon Steel Alloy Steel	2	180–350HB	0.03	0.2	0.04	0.3	0.045	0.3	0.05	0.3	0.055	0.3	0.06
M Stainless Steel	1,2,3,4	—	0.03	0.15	0.04	0.25	0.045	0.25	0.05	0.25	0.055	0.25	0.06	0.25
K Gray Cast Iron	1	≤350MPa	0.04	0.4	0.05	0.5	0.06	0.5	0.065	0.5	0.07	0.5	0.075	0.5
N Aluminium Alloy	1,2,3	—	0.04	0.2	0.05	0.3	0.06	0.3	0.065	0.3	0.07	0.3	0.075	0.3
H Hardened Steel	1	40–55HRC	0.02	0.15	0.03	0.25	0.035	0.25	0.04	0.25	0.045	0.25	0.05	0.25

Note 1) Helical grooving is strongly recommended for machining tempered steel.

Note 2) When using G1 breaker (VP15TF), please reduce the feed rate by 20%.

Note 3) For the details please refer to the cutting speed on page K175.

■ FOR RAMPING

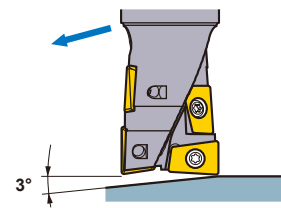

- When machining steel the recommended ramping angle is 3°. If a ramping angle larger than 3° is used, then the chips may not be broken effectively resulting in chips wrapping around the tool.
- During ramping, it is recommended to reduce the feed rate by 40% from the cutting conditions.

ROTATING TOOLS

MULTI FUNCTIONAL MILLING



AJX

- P
M
K
N
S
H

ROTATING TOOLS



Fig.1

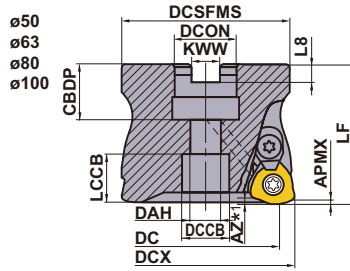
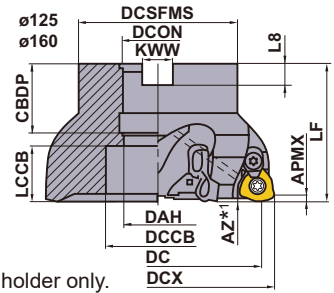

Fig.2



Right hand tool holder only.

(mm)

DCX mm size	Set Bolt	Geometry
ø50, ø52, ø63, ø66	HSC10030H	
ø80	HSC12035H	
ø100	HSC16040H	
ø125, ø160	MBA20040H	

ARBOR TYPE

With Coolant Hole

AJX09 GAMP :+8° GAMF :-6°	AJX12 GAMP :+8° GAMF :-5°—4°	AJX14 GAMP :+8° GAMF :-5°—3°
--	---	---

DCX (mm)	Order Number	Stock R	Number of Teeth	Dimensions (mm)			WT*2 (kg)	APMX (mm)	RMPX	Fig.	Insert Type
				DC	LF	DCON					
50	AJX12-050A03R	●	3	38.3	50	22	0.4	1.2	2°	1	JDM1204
50	AJX12-050A04R	●	4	38.3	50	22	0.4	1.2	2°	1	JDM1204
50	AJX09-050A05R	●	5	40	50	22	0.5	1.2	1.1°	1	JDM09T3
52	AJX12-052A03R	□	3	40.3	50	22	0.4	1.2	1.8°	1	JDM1204
52	AJX12-052A04R	●	4	40.3	50	22	0.4	1.2	1.8°	1	JDM1204
52	AJX09-052A05R	●	5	42	50	22	0.4	1.2	1.1°	1	JDM09T3
63	AJX14-063A03R	★	3	51.1	50	22	0.7	1.2	2.8°	1	JDM1405
63	AJX14-063A04R	●	4	51.1	50	22	0.7	1.2	2.8°	1	JDM1405
63	AJX12-063A05R	●	5	51.3	50	22	0.9	1.2	1.5°	1	JDM1204
66	AJX14-066A03R	□	3	54.1	50	22	0.7	1.2	2.5°	1	JDM1405
66	AJX14-066A04R	●	4	54.1	50	22	0.7	1.2	2.5°	1	JDM1405
66	AJX12-066A05R	●	5	54.3	50	22	0.8	1.2	2.5°	1	JDM1204
80	AJX14-080A04R	★	4	68.1	50	27	1.2	1.2	1.8°	1	JDM1405
80	AJX14-080A05R	●	5	68.1	50	27	1.2	1.2	1.8°	1	JDM1405
80	AJX12-080A06R	●	6	68.3	50	27	1.2	1.2	1.1°	1	JDM1204
100	AJX14-100A05R	●	5	88.1	63	32	2.4	1.2	1.2°	1	JDM1405
100	AJX14-100A06R	●	6	88.1	63	32	2.4	1.2	1.2°	1	JDM1405
100	AJX12-100A07R	●	7	88.3	63	32	2.6	1.2	0.8°	1	JDM1204
125	AJX14-125B05R	★	5	113.2	63	40	3.3	1.2	0.8°	2	JDM1405
125	AJX14-125B07R	●	7	113.2	63	40	3.3	1.2	0.8°	2	JDM1405
160	AJX14-160B06R	★	6	148.2	63	40	5	1.2	0.5°	2	JDM1405
160	AJX14-160B08R	★	8	148.2	63	40	5	1.2	0.5°	2	JDM1405

*1 Refer to page K187, for the max. drilling depth (AZ).

*2 WT : Tool Weight

Note 1) Refer to page K187, for the max. depth of cut (APMX) and max. drilling depth (AZ).

● : Inventory maintained. ★ : Inventory maintained in Japan.

□ : Non stock, produced to order only.





MOUNTING DIMENSIONS

DCX (mm)	Order Number	Dimensions (mm)								Fig.
		DCON	CBDP	DAH	DCCB	LCCB	DCSFMS	KWW	L8	
50	AJX12-050A03R	22	20	11	17	17.28	47	10.4	6.3	1
50	AJX12-050A04R	22	20	11	17	17.28	47	10.4	6.3	1
50	AJX09-050A05R	22	20	11	17	17.31	47	10.4	6.3	1
52	AJX12-052A03R	22	20	11	17	17.28	47	10.4	6.3	1
52	AJX12-052A04R	22	20	11	17	17.28	47	10.4	6.3	1
52	AJX09-052A05R	22	20	11	17	17.31	47	10.4	6.3	1
63	AJX14-063A03R	22	20	11	17	17.16	60	10.4	6.3	1
63	AJX14-063A04R	22	20	11	17	17.16	60	10.4	6.3	1
63	AJX12-063A05R	22	20	11	17	17.28	60	10.4	6.3	1
66	AJX14-066A03R	22	20	11	17	17.16	60	10.4	6.3	1
66	AJX14-066A04R	22	20	11	17	17.16	60	10.4	6.3	1
66	AJX12-066A05R	22	20	11	17	17.28	60	10.4	6.3	1
80	AJX14-080A04R	27	23	13	19	16.16	76	12.4	7	1
80	AJX14-080A05R	27	23	13	19	16.16	76	12.4	7	1
80	AJX12-080A06R	27	23	13	19	16.28	76	12.4	7	1
100	AJX14-100A05R	32	26	17	26	26.16	96	14.4	8	1
100	AJX14-100A06R	32	26	17	26	26.16	96	14.4	8	1
100	AJX12-100A07R	32	26	17	26	26.28	96	14.4	8	1
125	AJX14-125B05R	40	40	—	56	22.14	100	16.4	9	2
125	AJX14-125B07R	40	40	—	56	22.14	100	16.4	9	2
160	AJX14-160B06R	40	40	—	56	22.14	100	16.4	9	2
160	AJX14-160B08R	40	40	—	56	22.14	100	16.4	9	2

K

ROTATING TOOLS

SPARE PARTS

Tool Holder Type	 *		 *		
	Clamp Screw	Clamp Bridge	Clamp Bridge Screw	Spring	Wrench
AJX09	TS351	AMS3	AJS3010T10	ASS2	TKY10D
AJX12	TS43	AMS4	AJS4012T15	ASS2	TKY15T
AJX14	TS54	AMS5	AJS5014T25	ASS3	TKY25T

* Clamp Torque (N · m) : TS351=2.5, TS43=3.5, TS54=7.5, AJS3010T10=2.5, AJS4012T15=3.5, AJS5014T25=7.5

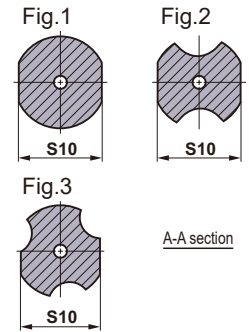
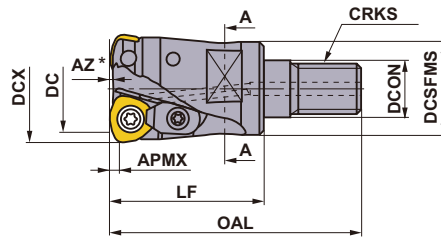

SCREW-IN TYPE

With Coolant Hole

Right hand tool holder only.

DCX (mm)	Order Number	Stock		Dimensions (mm)								*2 WT (kg)	APMX (mm)	RMPX	Fig.	Shank Type	Insert Type
		R	Number of Teeth	DC	LF	OAL	DCON	DCSFMS	S10	CRKS							
16	AJX06R162AM08	●	2	8.9	25	43	8.5	13	10	M8	0.1	0.6	3°	2	SC16M08	JOM06T2	
17	AJX06R172AM08	●	2	9.9	25	43	8.5	13	10	M8	0.1	0.6	2.5°	2	SC16M08	JOM06T2	
20	AJX08R202AM10	●	2	11.4	28	47	10.5	18	15	M10	0.1	0.9	3.5°	2	SC20M10	JOM0803	
20	AJX06R203AM10	●	3	12.9	28	47	10.5	18	15	M10	0.1	0.6	1.5°	3	SC20M10	JOM06T2	
22	AJX08R222AM10	●	2	13.4	28	47	10.5	18	15	M10	0.1	0.9	3°	2	SC20M10	JOM0803	
22	AJX06R223AM10	●	3	14.9	28	47	10.5	18	15	M10	0.1	0.6	1°	3	SC20M10	JOM06T2	
25	AJX09R252AM12	●	2	14.9	36	58	12.5	21	17	M12	0.2	1.2	4°	2	SC25M12	JDM09T3	
25	AJX08R253AM12	●	3	16.4	36	58	12.5	21	17	M12	0.1	0.9	2°	1	SC25M12	JOM0803	
28	AJX09R282AM12	●	2	17.9	36	58	12.5	21	17	M12	0.2	1.2	3°	2	SC25M12	JDM09T3	
28	AJX08R283AM12	●	3	19.4	36	58	12.5	21	17	M12	0.1	0.9	1.7°	1	SC25M12	JOM0803	
30	AJX12R302AM16	●	2	18.3	47	70	17	29	22	M16	0.3	1.2	4.5°	2	SC32M16	JDM1204	
30	AJX09R303AM16	●	3	20	47	70	17	29	22	M16	0.2	1.2	2.7°	1	SC32M16	JDM09T3	
32	AJX12R322AM16	●	2	20.3	47	70	17	29	22	M16	0.3	1.2	4°	2	SC32M16	JDM1204	
32	AJX09R323AM16	●	3	21.9	47	70	17	29	22	M16	0.2	1.2	2.5°	1	SC32M16	JDM09T3	
35	AJX12R352AM16	●	2	23.3	47	70	17	29	22	M16	0.3	1.2	3.5°	2	SC32M16	JDM1204	
35	AJX09R353AM16	●	3	24.9	47	70	17	29	22	M16	0.2	1.2	2°	1	SC32M16	JDM09T3	
40	AJX12R403AM16	●	3	28.3	60	83	17	29	22	M16	0.3	1.2	3°	2	SC32M16	JDM1204	
40	AJX09R404AM16	●	4	29.9	60	83	17	29	22	M16	0.2	1.2	1.5°	1	SC32M16	JDM09T3	

*1 Refer to page K187, for the max. drilling depth (AZ).

*2 WT : Tool Weight

Note 1) Refer to page K187, for the max. depth of cut (APMX) and max. drilling depth (AZ).

Note 2) For screw-in type arbors, refer to page K244.

● : Inventory maintained. ★ : Inventory maintained in Japan.



Fig.1

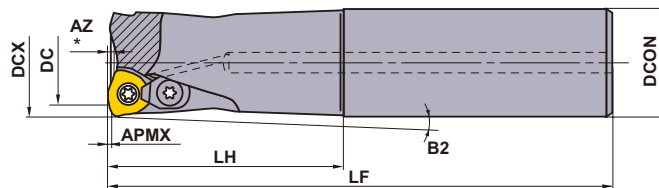
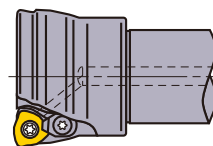

Fig.2



Right hand tool holder only.

STRAIGHT SHANK TYPE

With Coolant Hole

DCX (mm)	Order Number	Stock R	Number of Teeth	Dimensions (mm)				B2	APMX (mm)	RMPX	Fig.	Insert Type
				LF	DC	LH	DCON					
16	AJX06R162SA16ES	●	2	70	8.9	20	16	3.5°	0.6	3°	1	JOM06T2
16	AJX06R162SA16S	●	2	110	8.9	30	16	2.25°	0.6	3°	1	JOM06T2
16	AJX06R162SA16L	●	2	150	8.9	70	16	0.93°	0.6	3°	1	JOM06T2
16	AJX06R162SA16EL	★	2	200	8.9	100	16	0.64°	0.6	3°	1	JOM06T2
17	AJX06R172SA16ES	●	2	70	9.9	20	16	—	0.6	2.5°	1	JOM06T2
17	AJX06R172SA16S	●	2	110	9.9	20	16	—	0.6	2.5°	1	JOM06T2
17	AJX06R172SA16L	●	2	150	9.9	20	16	—	0.6	2.5°	1	JOM06T2
17	AJX06R172SA16EL	★	2	200	9.9	20	16	—	0.6	2.5°	1	JOM06T2
20	AJX08R202SA20S	●	2	130	11.4	50	20	1.34°	0.9	3.5°	1	JOM08O3
20	AJX06R203SA20S	●	3	130	12.9	50	20	1.31°	0.6	1.5°	1	JOM06T2
20	AJX08R202SA20L	●	2	180	11.4	100	20	0.65°	0.9	3.5°	1	JOM08O3
20	AJX06R203SA20L	●	3	180	12.9	100	20	0.64°	0.6	1.5°	1	JOM06T2
20	AJX08R202SA20EL	★	2	250	11.4	130	20	0.5°	0.9	3.5°	1	JOM08O3
22	AJX08R222SA20S	●	2	130	13.4	30	20	—	0.9	3°	1	JOM08O3
22	AJX06R223SA20S	●	3	130	14.9	30	20	—	0.6	1°	1	JOM06T2
22	AJX08R222SA20L	●	2	180	13.4	30	20	—	0.9	3°	1	JOM08O3
22	AJX06R223SA20L	●	3	180	14.9	30	20	—	0.6	1°	1	JOM06T2
22	AJX08R222SA20EL	★	2	250	13.4	30	20	—	0.9	3°	1	JOM08O3
25	AJX09R252SA25S	●	2	140	14.9	60	25	1.1°	1.2	4°	1	JDM09T3
25	AJX08R253SA25S	●	3	140	16.4	60	25	1.1°	0.9	2°	1	JOM08O3
25	AJX09R252SA25L	●	2	200	14.9	120	25	0.54°	1.2	4°	1	JDM09T3
25	AJX08R253SA25L	●	3	200	16.4	120	25	0.54°	0.9	2°	1	JOM08O3
25	AJX09R252SA25EL	★	2	300	14.9	180	25	0.36°	1.2	4°	1	JDM09T3
28	AJX09R282SA25S	●	2	140	17.9	40	25	—	1.2	3°	1	JDM09T3
28	AJX08R283SA25S	●	3	140	19.4	40	25	—	0.9	1.7°	1	JOM08O3
28	AJX09R282SA25L	●	2	200	17.9	40	25	—	1.2	3°	1	JDM09T3
28	AJX08R283SA25L	●	3	200	19.4	40	25	—	0.9	1.7°	1	JOM08O3
28	AJX09R282SA25EL	★	2	300	17.9	40	25	—	1.2	3°	1	JDM09T3
30	AJX12R302SA32S	●	2	150	18.3	70	32	1.82°	1.2	4.5°	1	JDM12O4
30	AJX09R303SA32S	●	3	150	20	70	32	1.79°	1.2	2.7°	1	JDM09T3
30	AJX12R302SA32L	●	2	200	18.3	120	32	1.04°	1.2	4.5°	1	JDM12O4
30	AJX09R303SA32L	●	3	200	20	120	32	1.03°	1.2	2.7°	1	JDM09T3
30	AJX12R302SA32EL	★	2	300	18.3	180	32	0.69°	1.2	4.5°	1	JDM12O4
32	AJX12R322SA32S	●	2	150	20.3	70	32	0.96°	1.2	4°	1	JDM12O4
32	AJX09R323SA32S	●	3	150	21.9	70	32	0.94°	1.2	2.5°	1	JDM09T3
32	AJX12R322SA32L	●	2	200	20.3	120	32	0.55°	1.2	4°	1	JDM12O4
32	AJX09R323SA32L	●	3	200	21.9	120	32	0.54°	1.2	2.5°	1	JDM09T3
32	AJX12R322SA32EL	★	2	300	20.3	180	32	0.36°	1.2	4°	1	JDM12O4
35	AJX12R352SA32S	●	2	150	23.3	50	32	—	1.2	3.5°	1	JDM12O4
35	AJX09R353SA32S	●	3	150	24.9	50	32	—	1.2	2°	1	JDM09T3
35	AJX12R352SA32L	●	2	200	23.3	50	32	—	1.2	3.5°	1	JDM12O4
35	AJX09R353SA32L	●	3	200	24.9	50	32	—	1.2	2°	1	JDM09T3
35	AJX12R352SA32EL	★	2	300	23.3	50	32	—	1.2	3.5°	1	JDM12O4

* Refer to page K187, for the max. drilling depth (AZ).

Note 1) Refer to page K187, for the max. depth of cut (APMX) and max. drilling depth (AZ).

ROTATING TOOLS







K
ROTATING TOOLS

DCX (mm)	Order Number	Stock	Number of Teeth	Dimensions (mm)				B2	APMX (mm)	RMPX	Fig.	Insert Type
		R		LF	DC	LH	DCON					
40	AJX12R403SA32S	●	3	150	28.3	50	32	—	1.2	3°	1	JDM1204
40	AJX09R404SA32S	●	4	150	29.9	50	32	—	1.2	1.5°	1	JDM09T3
40	AJX12R403SA32L	●	3	250	28.3	50	32	—	1.2	3°	1	JDM1204
40	AJX09R404SA32L	●	4	250	29.9	50	32	—	1.2	1.5°	1	JDM09T3
40	AJX12R402SA32EL	★	2	350	28.3	50	32	—	1.2	3°	1	JDM1204
40	AJX12R403SA40S	●	3	150	28.3	70	40	0.35°	1.2	0.95°	1	JDM1204
40	AJX09R404SA40S	●	4	150	29.9	70	40	1.8°	1.2	1.8°	1	JDM09T3
40	AJX12R403SA40L	□	3	250	28.3	70	40	0.35°	1.2	0.95°	1	JDM1204
40	AJX09R404SA40L	□	4	250	29.9	70	40	0.43°	1.2	0.92°	1	JDM09T3
40	AJX12R402SA40EL	□	2	350	28.3	70	40	0.35°	1.2	0.95°	1	JDM1204
40	AJX12R403SA42S	★	3	150	28.3	70	42	1.79°	1.2	3°	1	JDM1204
40	AJX12R403SA42L	★	3	250	28.3	70	42	1.79°	1.2	3°	1	JDM1204
40	AJX12R402SA42EL	★	2	350	28.3	70	42	1.79°	1.2	3°	1	JDM1204
50	AJX14R503SA40S	●	3	150	38.2	50	40	—	1.2		1	JDM1405
50	AJX14R503SA40L	□	3	250	38.2	50	40	—	1.2		1	JDM1405
50	AJX14R503SA42S	★	3	150	38.2	50	42	—	1.2	4.2°	1	JDM1405
50	AJX14R503SA42L	★	3	250	38.1	50	42	—	1.2	4.2°	1	JDM1405
63	AJX14R634SA40S	□	4	150	51.1	50	40	—	1.2		2	JDM1405
63	AJX14R634SA40L	□	4	250	51.1	50	40	—	1.2		2	JDM1405
63	AJX14R634SA42S	★	4	150	51.1	50	42	—	1.2	2.8°	2	JDM1405
63	AJX14R634SA42L	★	4	250	51.1	50	42	—	1.2	2.8°	2	JDM1405

Note 1) Refer to page K187, for the max. drilling depth (AZ).

Note 2) Refer to page K187, for the max. depth of cut (APMX) and max. drilling depth (AZ).

SPARE PARTS







Tool Holder Type	 *		 *		 F  D
	Clamp Screw	Clamp Bridge	Clamp Bridge Screw	Spring	Wrench
AJX06R162	TS25	—	—	—	TKY08F
AJX06R172	TS25	—	—	—	TKY08F
AJX06R203	TS25	—	—	—	TKY08F
AJX06R223	TS25	—	—	—	TKY08F
AJX08R202	TS33	—	—	—	TKY08D
AJX08R222	TS33	—	—	—	TKY08D
AJX08R253	TS33	—	—	—	TKY08D
AJX08R283	TS33	—	—	—	TKY08D
AJX09R252	TS351	AMS3	AJS3010T10	ASS2	TKY10D
AJX09R282	TS351	AMS3	AJS3010T10	ASS2	TKY10D
AJX09R303	TS351	AMS3	AJS3010T10	ASS2	TKY10D
AJX09R323	TS351	AMS3	AJS3010T10	ASS2	TKY10D
AJX09R353	TS351	AMS3	AJS3010T10	ASS2	TKY10D
AJX09R404	TS351	AMS3	AJS3010T10	ASS2	TKY10D
AJX12R302	TS407	AMS4	AJS4012T15	ASS2	TKY15D
AJX12R322	TS43	AMS4	AJS4012T15	ASS2	TKY15D
AJX12R352	TS43	AMS4	AJS4012T15	ASS2	TKY15D
AJX12R402	TS43	AMS4	AJS4012T15	ASS2	TKY15D
AJX12R403	TS43	AMS4	AJS4012T15	ASS2	TKY15D
AJX14R503	TS54	AMS5	AJS5014T25	ASS3	TKY25D
AJX14R634	TS54	AMS5	AJS5014T25	ASS3	TKY25D

* Clamp Torque (N · m) : TS25=1.0, TS33=1.0, TS351=2.5, TS407=3.5, TS43=3.5, TS54=7.5, AJS3010T10=2.5, AJS4012T15=3.5, AJS5014T25=7.5

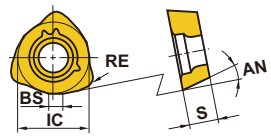
● : Inventory maintained. ★ : Inventory maintained in Japan.

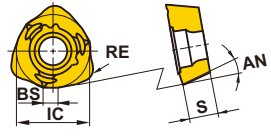
□ : Non stock, produced to order only. (10 inserts in one case)

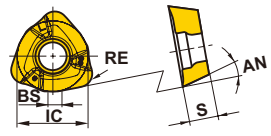
INSERTS

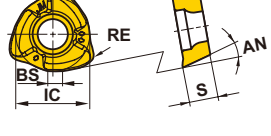
Work Material	P	Steel	●	●	●											Cutting Conditions : ● : Stable Cutting ● : General Cutting ✖ : Unstable Cutting		
	M	Stainless Steel				●	●											
K	Cast Iron																	
S	Heat-resistant Alloy, Titanium Alloy																	
H	Hardened Materials																	
Shape	Order Number	Class	Coated								Dimensions (mm)				AN	Geometry		
			FH7020	MP6120	MP6130	MP7130	MP7140	MP9120	MP9130	MP9140 <small>NEW</small>	VP15TF	VP30RT	IC	S			BS	RE
Partial Profile FT Breaker 	JOMW06T215ZZSR-FT	M	●	●	●	●	●	●	●	●	●	6.35	2.78	1.2	1.5	13°		
	JOMW080320ZZSR-FT	M	●	●	●	●	●	●	●	●	●	8	3.18	1.4	2	13°		
	JDMW09T320ZDSR-FT	M	●	●	●	●	●	●	●	●	●	9.525	3.97	1.8	2	15°		
	JDMW120420ZDSR-FT	M	●	●	●	●	●	●	●	●	●	12	4.76	2.5	2	15°		
	JDMW140520ZDSR-FT	M	●	●	●	●	●	●	●	●	●	14	5.56	2.8	2	15°		
Strong Cutting Edge Type ST Breaker 	JDMT120420ZDSR-ST	M	●	●	●	●	●				●	●	12	4.76	2.5	2	15°	
	JDMT140520ZDSR-ST	M	●	●	●	●	●				●	●	14	5.56	2.8	2	15°	
Focus on cutting edge sharpness (For Difficult-to-cut Materials) JL Breaker 	JOMT06T216ZZER-JL	M				●	●	●	●	●		6.35	2.78	1.2	1.6	13°		
	JOMT080322ZZER-JL	M				●	●	●	●	●		8	3.18	1.4	2.2	13°		
	JDMT09T323ZDER-JL	M				●	●	●	●	●		9.525	3.97	1.8	2.3	15°		
	JDMT120423ZDER-JL	M				●	●	●	●	●		12	4.76	2.5	2.3	15°		
	JDMT140523ZDER-JL	M				●	●	●	●	●		14	5.56	2.8	2.3	15°		
Focus on cutting edge sharpness (For General Cutting) JM Breaker 	JOMT06T215ZZSR-JM	M	●	●	●	●	●	●	●	●	●	6.35	2.78	1.2	1.5	13°		
	JOMT080320ZZSR-JM	M	●	●	●	●	●	●	●	●	●	8	3.18	1.4	2	13°		
	JDMT09T320ZDSR-JM	M	●	●	●	●	●	●	●	●	●	9.525	3.97	1.8	2	15°		
	JDMT120420ZDSR-JM	M	●	●	●	●	●	●	●	●	●	12	4.76	2.5	2	15°		
	JDMT140520ZDSR-JM	M	●	●	●	●	●	●	●	●	●	14	5.56	2.8	2	15°		

Note 1) Setting height for ST chipbreaker is slightly different from that of other chipbreakers.
 If you use ST chipbreaker, check the setting height.

● = NEW

K
ROTATING TOOLS

ROTATING TOOLS

RECOMMENDED CUTTING CONDITIONS

CUTTING SPEED

Work Material	Characteristics	Cutting Speed (m/min) for Different Grades			
		FH7020	MP6120	MP6130	VP30RT
P					
Mild Steel	Hardness ≤180HB	170 (120–220)	150 (100–200)	130 (80–180)	110 (60–160)
Carbon Steel Alloy Steel	Hardness 180–280HB	150 (100–200)	130 (80–180)	110 (60–160)	90 (40–140)
Carbon Steel Alloy Steel	Hardness 280–350HB	130 (80–180)	100 (50–150)	80 (30–130)	60 (20–110)
Alloy Tool Steel	Hardness ≤350HB (Annealing)	130 (80–180)	100 (50–150)	80 (30–120)	60 (20–90)
Pre-hardened Steel	Hardness 35–45HRC	–	100 (70–130)	80 (50–110)	80 (30–90)
M					
Stainless Steel	Hardness ≤270HB	140 (100–180)	120 (80–160)	–	–
K					
Gray Cast Iron	Tensile Strength ≤350MPa	150 (100–200)	–	–	–
Ductile Cast Iron	Tensile Strength ≤800MPa	–	120 (80–160)	–	–
S					
Heat Resistant Alloy	Hardness ≤350HB	30 (20–40)	25 (20–35)	20 (15–30)	–
Titanium Alloy	–	50 (40–60)	45 (30–55)	40 (30–50)	–
H					
Hardened Steel	Hardness 40–55HRC	70 (50–90)	–	–	–

K

ROTATING TOOLS

MAXIMUM CAPACITIES BY MODE

■ RAMPING

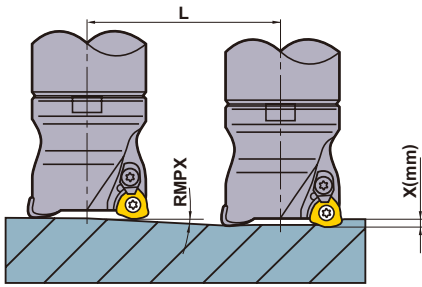

■ HELICAL DRILLING

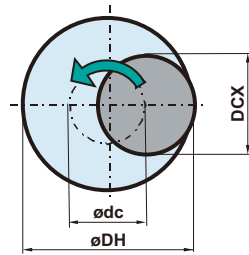

- How to derive a locus of the centre of the tool.

$$\text{ødc} = \text{øDH} - \text{DCX}$$

Locus of the centre of the tool Desired hole diameter Cutting Diameter Maximum
- For the depth of cut per pass, refer to the cutting conditions above for helical drilling.
- Set the machine spindle revolution so that the tool is rotating and cutting in a down cut direction.

- When ramping and helical cutting, please apply a lower feed (60% of the calculated feed rate or less).
- When drilling, please set the feed in the axial direction at 0.2 mm/rev or less.
- The long chips generated can disperse, ensure that adequate safety precautions are taken.

Tool Holder Type	DCX (mm)	DC (mm)	APMX (mm)		RMPX	Ramping				Helical Drilling		AZ (mm)	
			FT/JM/ST Breaker	JL Breaker		L Required distance for X mm depth (mm)				DH (mm)			
						X=1	X=1.2	X=1.5	X=2	Min	Max		
Shank type/Screw-in type	AJX06	16	8.9	1	0.6	3°	19.1	—	—	—	23	29	0.3
	AJX06	17	9.9	1	0.6	2.5°	22.9	—	—	—	25	31	0.3
	AJX06	20	12.9	1	0.6	1.5°	38.2	—	—	—	31	37	0.3
	AJX06	22	14.9	1	0.6	1°	57.3	—	—	—	35	41	0.3
	AJX08	20	11.4	1.5	0.9	3.5°	16.3	19.6	24.5	—	27	36	0.5
	AJX08	22	13.4	1.5	0.9	3°	19.1	22.9	28.6	—	31	40	0.5
	AJX08	25	16.4	1.5	0.9	2°	28.6	34.4	43	—	37	46	0.5
	AJX08	28	19.4	1.5	0.9	1.7°	33.7	40.4	50.5	—	43	52	0.5
	AJX09	25	14.9	2	1.2	4°	14.3	17.2	21.5	28.6	33	46	1
	AJX09	28	17.9	2	1.2	3°	19.1	22.9	28.6	38.1	39	52	1
	AJX09	30	20	2	1.2	2.7°	21.2	25.4	31.8	42.4	43	56	1
	AJX09	32	21.9	2	1.2	2.5°	22.9	27.5	34.4	45.8	47	60	1
	AJX09	35	24.9	2	1.2	2°	28.6	34.4	43	57.3	53	66	1
	AJX09	40	29.9	2	1.2	1.5°	38.2	45.8	57.3	76.4	63	76	1
	AJX12	30	18.3	2	1.2	4.5°	12.7	15.2	19	25.4	39	56	1.5
	AJX12	32	20.3	2	1.2	4°	14.3	17.2	21.4	28.6	41	60	1.5
	AJX12	35	23.3	2	1.2	3.5°	16.3	19.6	24.5	32.7	47	66	1.5
	AJX12	40	28.3	2	1.2	3°	19.1	22.9	28.6	38.2	57	76	1.5
	AJX14	50	38.2	2	1.2	4.2°	13.6	16.3	20.4	27.2	72	96	2
	AJX14	63	51.1	2	1.2	2.8°	20.4	24.5	30.7	40.9	98	122	2
Arbor type	AJX09	50	40	2	1.2	1.1°	52.1	62.5	78.1	104.2	83	96	1
	AJX12	50	38.3	2	1.2	2°	28.6	34.4	43	57.3	77	96	1.5
	AJX12	63	51.3	2	1.2	1.5°	38.2	45.8	57.3	76.4	103	122	1.5
	AJX12	80	68.3	2	1.2	1.1°	52.1	62.5	78.1	104.2	137	156	1.5
	AJX12	100	88.3	2	1.2	0.8°	71.6	85.9	107.4	143.2	177	196	1.5
	AJX14	63	51.1	2	1.2	2.8°	20.4	24.5	30.7	40.9	98	122	2
	AJX14	80	68.1	2	1.2	1.8°	31.8	38.2	47.7	63.6	132	156	2
	AJX14	100	88.1	2	1.2	1.2°	47.7	57.3	71.6	95.5	172	196	2
	AJX14	125	113.2	2	1.2	0.8°	71.6	85.9	107.4	143.2	222	246	2
AJX14	160	148.2	2	1.2	0.5°	114.6	137.5	171.9	229.2	292	316	2	

RECOMMENDED CUTTING CONDITIONS

DEPTH OF CUT / FEED

Work Material	Characteristics	Shank Type / Screw-in Type									
		DCX=ø16, ø17			DCX=ø20, ø22			DCX=ø25, ø28			
		L	ap	fz (mm/t.)	L	ap	fz (mm/t.)	L	ap	fz (mm/t.)	
P Mild Steel	Hardness ≤180HB	140	0.8	0.8	160	1.0	1.0	170	1.0	1.2	
		180	0.6	0.6	210	0.8	0.8	230	0.8	1.0	
		210	0.4	0.4	240	0.6	0.6	290	0.6	0.8	
	Carbon Steel Alloy Steel	Hardness 180–280HB	140	0.8	0.8	160	1.0	1.0	170	1.0	1.2
			180	0.6	0.6	210	0.8	0.8	230	0.8	1.0
			210	0.4	0.4	240	0.6	0.6	290	0.6	0.8
	Carbon Steel Alloy Steel	Hardness 280–350HB	140	0.7	0.8	160	0.8	1.0	170	0.8	1.2
			180	0.5	0.6	210	0.6	0.8	230	0.6	1.0
			210	0.3	0.4	240	0.4	0.6	290	0.4	0.8
	Alloy Tool Steel	Hardness ≤350HB	140	0.7	0.8	160	0.8	1.0	170	0.8	1.2
			180	0.5	0.6	210	0.6	0.8	230	0.6	1.0
			210	0.3	0.4	240	0.4	0.6	290	0.4	0.8
	Pre-hardened Steel	Hardness 35–45HRC	140	0.7	0.7	160	0.8	0.8	170	0.8	1.0
			180	0.5	0.5	210	0.6	0.6	230	0.6	0.8
			210	0.3	0.3	240	0.4	0.4	290	0.4	0.6
	M Stainless Steel	Hardness ≤270HB	140	0.8	0.7	160	1.0	0.8	170	1.0	1.0
			180	0.6	0.5	210	0.8	0.6	230	0.8	0.8
			210	0.4	0.3	240	0.6	0.4	290	0.6	0.6
K Gray Cast Iron	Tensile Strength ≤350MPa	140	0.8	1.0	160	1.0	1.2	170	1.0	1.4	
		180	0.6	0.8	210	0.8	1.0	230	0.8	1.2	
		210	0.4	0.6	240	0.6	0.8	290	0.6	1.0	
	Ductile Cast Iron	Tensile Strength ≤800MPa	140	0.7	0.8	160	0.8	1.0	170	0.8	1.2
			180	0.5	0.6	210	0.6	0.8	230	0.6	1.0
			210	0.3	0.4	240	0.4	0.6	290	0.4	0.8
S Heat Resistant Alloy	Hardness ≤350HB	140	0.6	0.6	160	0.8	0.6	170	1.0	0.6	
		180	0.4	0.4	210	0.6	0.4	230	0.8	0.4	
	Titanium Alloy	—	210	0.3	0.3	240	0.4	0.3	290	0.6	0.3
H Hardened Steel	Hardness 40–55HRC	140	0.5	0.5	160	0.5	0.6	170	0.5	0.8	
		180	0.4	0.3	210	0.4	0.4	230	0.4	0.6	
		210	0.3	0.2	240	0.3	0.2	290	0.3	0.4	

ROTATING TOOLS

K

① Overhang Length L

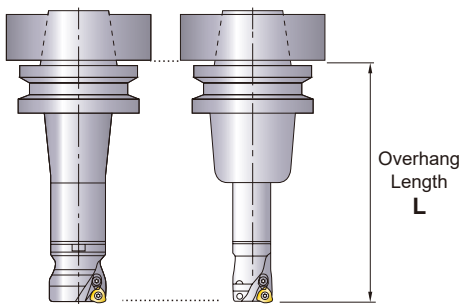

② Main Spindle Revolution

$$n(\text{min}^{-1}) = (\text{Recommended Cutting Speed} \times 1000) \div (\text{DCX} \times 3.14)$$

③ Table Feed Rate

$$V_f(\text{mm/min}) = n \times \text{Feed per Tooth} \times \text{Number of Teeth}$$

- ④ Recommended width of cut (ae) is more than 60% of the cutting edge diameter (DCX).
- ⑤ The above cutting conditions are guides to cutting on a #50 BT machine. In case of #40 BT and #63 HSK machines, a cutting edge diameter of under 35mm is recommended. In this case, reduce the depth of cut and table feed rate.
- ⑥ Use of ST chipbreaker with tougher cutting edges is recommended for machining parts that require interrupted cutting. First recommended insert grade for non-standard 06/08/09 ST chipbreakers is VP30RT irrespective of the work material.
- ⑦ A cutter body with coarse pitch is recommended for unstable cutting caused by a long tool overhang.
- ⑧ Use the "sharp" JM chipbreaker to lower cutting forces or when long tool overhangs are used.
- ⑨ Heavy chips are generated when machining with the AJX. To avoid chip jamming-related problems, use air blow while machining to discharging chips effectively.
- ⑩ The maximum depth of cut of JL breaker is different in the insert size. 06 size is up to 0.6 mm, 08 size is up to 0.9 mm, and 09,12,14 size is up to 1.2 mm.

(mm)

	Shank Type / Screw-in Type												Arbor Type					
	DCX=ø30, ø32, ø35			DCX=ø40 (ø32 Shank)			DCX=ø40 (ø42 Shank)			DCX=ø50, ø63			DCX=ø50, ø63			DCX=ø80, ø100, ø125, ø160		
	L	ap	fz (mm/t.)	L	ap	fz (mm/t.)	L	ap	fz (mm/t.)	L	ap	fz (mm/t.)	L	ap	fz (mm/t.)	L	ap	fz (mm/t.)
180	1.2	1.4	180	1.2	1.4	180	1.2	1.5	180	1.4	1.5	150	1.5	1.5	170	1.5	1.5	
230	1.0	1.2	240	1.0	1.2	240	1.0	1.3	240	1.2	1.3	250	1.3	1.3	300	1.3	1.3	
290	0.8	1.0	300	0.8	1.0	300	0.8	1.1	—	—	—	350	1.1	1.1	450	1.0	1.0	
180	1.2	1.4	180	1.2	1.4	180	1.2	1.5	180	1.4	1.5	150	1.5	1.5	170	1.5	1.5	
230	1.0	1.2	240	1.0	1.2	240	1.0	1.3	240	1.2	1.3	250	1.3	1.3	300	1.3	1.3	
290	0.8	1.0	300	0.8	1.0	300	0.8	1.1	—	—	—	350	1.1	1.1	450	1.0	1.0	
180	1.0	1.4	180	1.0	1.4	180	1.0	1.5	180	1.2	1.5	150	1.3	1.5	170	1.3	1.5	
230	0.8	1.2	240	0.8	1.2	240	0.8	1.3	240	1.0	1.3	250	1.1	1.3	300	1.1	1.3	
290	0.6	1.0	300	0.6	1.0	300	0.6	1.1	—	—	—	350	0.9	1.1	450	0.8	1.0	
180	1.0	1.4	180	1.0	1.4	180	1.0	1.5	180	1.2	1.5	150	1.3	1.5	170	1.3	1.5	
230	0.8	1.2	240	0.8	1.2	240	0.8	1.3	240	1.0	1.3	250	1.1	1.3	300	1.1	1.3	
290	0.6	1.0	300	0.6	1.0	300	0.6	1.1	—	—	—	350	0.9	1.1	450	0.8	1.0	
180	1.0	1.2	180	1.0	1.2	180	1.0	1.3	180	1.2	1.3	150	1.3	1.3	170	1.3	1.3	
230	0.8	1.0	240	0.8	1.0	240	0.8	1.1	240	1.0	1.1	250	1.1	1.1	300	1.1	1.1	
290	0.6	0.8	300	0.6	0.8	300	0.6	0.9	—	—	—	350	0.9	0.9	450	0.8	0.8	
180	1.2	1.2	180	1.2	1.2	180	1.2	1.3	180	*1.4	1.3	150	*1.5	1.3	170	*1.5	1.3	
230	1.0	1.0	240	1.0	1.0	240	1.0	1.1	240	1.2	1.1	250	*1.3	1.1	300	*1.3	1.1	
290	0.8	0.8	300	0.8	0.8	300	0.8	0.9	—	—	—	350	1.1	0.9	450	1.0	0.8	
180	1.2	1.6	180	1.2	1.6	180	1.2	1.7	180	1.4	1.7	150	1.5	1.7	170	1.5	1.7	
230	1.0	1.4	240	1.0	1.4	240	1.0	1.5	240	1.2	1.5	250	1.3	1.5	300	1.3	1.5	
290	0.8	1.2	300	0.8	1.2	300	0.8	1.3	—	—	—	350	1.1	1.3	450	1.0	1.2	
180	1.0	1.4	180	1.0	1.4	180	1.0	1.5	180	1.2	1.5	150	1.3	1.5	170	1.3	1.5	
230	0.8	1.2	240	0.8	1.2	240	0.8	1.3	240	1.0	1.3	250	1.1	1.3	300	1.1	1.3	
290	0.6	1.0	300	0.6	1.0	300	0.6	1.1	—	—	—	350	0.9	1.1	450	0.8	1.0	
180	1.2	0.6	180	1.2	0.6	180	1.2	0.6	180	1.2	0.6	150	1.2	0.6	170	1.2	0.6	
230	1.0	0.4	240	1.0	0.4	240	1.0	0.4	240	1.0	0.4	250	1.0	0.4	300	1.0	0.4	
290	0.8	0.3	300	0.8	0.3	300	0.8	0.3	—	—	—	350	0.8	0.3	450	0.8	0.3	
180	0.6	1.0	180	0.6	1.0	180	0.6	1.1	180	0.8	1.1	150	0.9	1.1	170	0.9	1.1	
230	0.5	0.8	240	0.5	0.8	240	0.5	0.9	240	0.6	0.9	250	0.7	0.9	300	0.7	0.9	
290	0.4	0.6	300	0.4	0.6	300	0.4	0.7	—	—	—	—	—	—	—	—	—	

* Depth of cut of JL breaker is up to 1.2 mm.

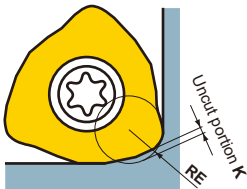
NOTE FOR PROGRAMMING

When using the AJX, please programme as an RE radius cutter. The approximate uncut portions for the programme are as follows.

(mm)

Insert Size	Breaker	Approx. RE	Uncut Portion K
06	FT / JM	2.0	0.33
	JL	2.5	0.32
08	FT / JM	2.5	0.46
	JL	2.0	0.40
09	FT / JM	3.0	0.47
	JL	3.0	0.46
12	FT / JM / ST	3.0	0.63
	JL	3.0	0.53
14	FT / JM / ST	3.0	0.64
	JL	3.0	0.55

Note 1) The uncut portion may change slightly depending on cutting conditions.

K

ROTATING TOOLS

ROTATING TOOLS

MULTI FUNCTIONAL MILLING



BRP

- P
M
K
N
S
H

ROTATING TOOLS

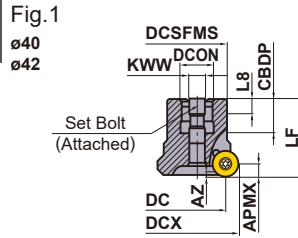

Set an attached bolt.

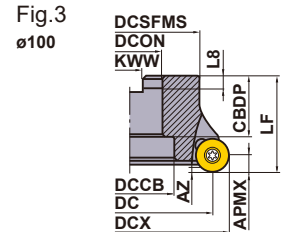
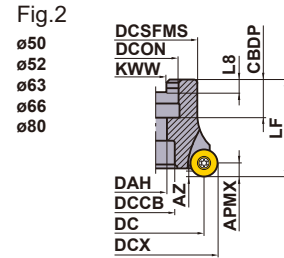

ARBOR TYPE

GAMP: +5°
GAMF: -4°-0°

Right hand tool holder only.

Cutting Edge R (APMX)	Order Number	Stock R	Number of Teeth	Dimensions (mm)										*2 WT (kg)	Max. Depth of Cut (mm)		*1 Clamp Screw	Wrench	Set Bolt	Type (Fig.)
				DCX	DC	DCSFMS	LF	DCON	CBBDP	DAH	KWW	L8	DCCB		APMX	AZ				
6	BRP6P-040A03R	★	3	40	27.9	30	40	16	18	-	8.4	5.6	-	0.4	6	4	TS43	TKY15D	HDS08030	1
	BRP6P-050A04R	★	4	50	37.8	41	50	22	20	11	10.4	6.3	-	0.5	6	4	TS43	TKY15D	-	2
	BRP6P-063A05R	★	5	63	50.8	42	50	22	20	11	10.4	6.3	-	0.7	6	4	TS43	TKY15D	-	2
	BRP6N-042A04R	●	4	42	29.8	30	40	16	18	-	8.4	5.6	-	0.4	6	4	TS43	TKY15D	HDS08030	1
	BRP6N-050A04R	●	4	50	37.8	41	50	22	20	11	10.4	6.3	-	0.5	6	4	TS43	TKY15D	-	2
	BRP6N-052A05R	●	5	52	39.8	41	63	22	20	11	10.4	6.3	-	0.5	6	4	TS43	TKY15D	-	2
	BRP6N-063A05R	●	5	63	50.8	42	50	22	20	11	10.4	6.3	-	0.7	6	4	TS43	TKY15D	-	2
	BRP6N-066A06R	●	6	66	53.8	42	63	22	20	11	10.4	6.3	-	0.7	6	4	TS43	TKY15D	-	2
8	BRP8P-063A04R	★	4	63	46.8	42	50	22	20	11	10.4	6.3	-	0.7	8	5.5	TS54	TKY25D	-	2
	BRP8N-063A04R	●	4	63	46.8	42	50	22	20	11	10.4	6.3	-	0.7	8	5.5	TS54	TKY25D	-	2
	BRP8N-080A06R	●	6	80	63.8	60	50	27	22	13	12.4	8	-	1.2	8	5.5	TS54	TKY25D	-	2
	BRP8N-100B07R	●	7	100	83.8	70	50	32	32	-	14.4	8	45	1.6	8	5.5	TS54	TKY25D	-	3

*1 Clamp Torque (N·m) : TS43=3.5, TS54=7.5

*2 WT : Tool Weight

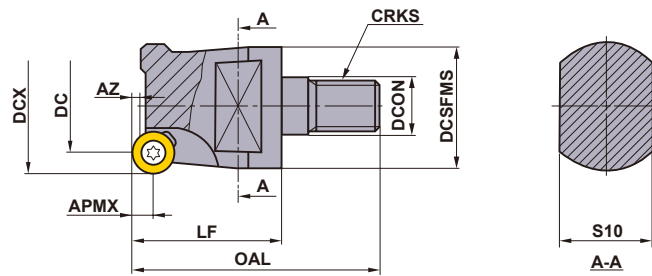

Right hand tool holder only.

SCREW-IN TYPE

Type	Order Number	Stock R	Number of Teeth	Dimensions (mm)										* Clamp Screw	Wrench	Insert
				DCX	DC	OAL	LF	DCON	DCSFMS	S10	CRKS	APMX	AZ			
BRP4	BRP4NR161M08	●	1	16	7.8	46	28	8.5	13	10	M8	4	1	CS250560T	TKY08F	①RPMW08T2M0E/T ②RPMT08T2M0E-JS
	BRP4NR202M10	●	2	20	11.8	47	28	10.5	18	15	M10	4	2			
	BRP4NR253M12	●	3	25	16.8	54	32	12.5	21	17	M12	4	2			
	BRP4NR323M16	●	3	32	23.8	59	36	17	29	22	M16	4	2			
BRP5	BRP5NR201M10	●	1	20	9.8	51	32	10.5	18	15	M10	5	1.2	CS350760T	TKY15F	①RPMW10T3M0E/T ②RPMT10T3M0E-JS
	BRP5NR252M12	●	2	25	14.8	54	32	12.5	21	17	M12	5	2.5			
	BRP5NR323M12	●	3	32	21.8	58	36	17	29	22	M16	5	2.5			
	BRP5NR323M16	●	3	32	21.8	59	36	17	29	22	M16	5	2.5			
BRP6	BRP6NR322M16	●	2	32	19.8	58	35	17	29	22	M16	6	4	TS43	TKY15F	①RPMW1204M0E/T ②RPMW1204M0E-JS
	BRP6NR403M16	●	3	40	27.8	66	43	17	29	22	M16	6	4			
	BRP6NR424M16	●	4	42	29.8	66	43	17	29	22	M16	6	4			



Note 1) For screw-in type arbors, refer to page K244.

* Clamp Torque (N·m) : CS250560T=1.0, CS350760T=3.5, CS350860T=3.5, TS43=3.5

● : Inventory maintained. ★ : Inventory maintained in Japan.

□ : Non stock, produced to order only. (10 inserts in one case)

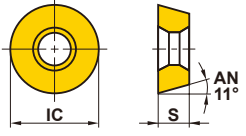
INSERTS

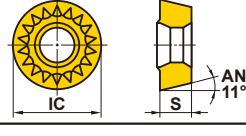
Work Material	P	Steel	●	●	●	●	●	●	●	Cutting Conditions (Guide): ●: Stable Cutting ●: General Cutting ✖: Unstable Cutting Honing: E: Round T: Chamfer		
	M	Stainless Steel	●	●	●	●	●	●	●			
Shape	K	Cast Iron	●	●	●	●	●	●	●	Dimensions (mm) IC S Geometry		
	S	Heat-resistant Alloy, Titanium Alloy	●	●	●	●	●	●	●			
	H	Hardened Materials	●	●	●	●	●	●	●			
Order Number	Class	Honing	Coated			Cermet		Carbide		IC	S	Geometry
			F7010	F7030	VP15TF	AP20M	NX2525	NX4545	UTi20T			
	RPMW08T2M0E	M	E							8	2.78	
	RPMW08T2M0T	M	T		●					8	2.78	
	RPMW10T3M0E	M	E		★			★	□	10	3.97	
	RPMW10T3M0T	M	T			●				10	3.97	
	RPMW1204M0E	M	E		●		●	□	●	12	4.76	
	RPMW1204M0T	M	T			●				12	4.76	
	RPMW1606M0E	M	E		●		●	□	●	16	6.35	
	RPMW1606M0T	M	T			●				16	6.35	
	RPMT08T2M0E-JS	M	E		●	●			●	8	2.78	
	RPMT10T3M0E-JS	M	E		●	●			●	10	3.97	
	RPMT1204M0E-JS	M	E	●	●	●	●		●	12	4.76	
	RPMT1606M0E-JS	M	E	●	●	●			●	16	6.35	

K
ROTATING TOOLS

RECOMMENDED CUTTING CONDITIONS

■ CUTTING SPEED (m/min)

Work Material	Hardness	Coated		Carbide	
		F7030	VP15TF	UTi20T	
P	Mild Steel	≤180HB	250 (200–300)	250 (200–300)	150 (100–200)
	Carbon Steel Alloy Steel	180–280HB	180 (130–220)	180 (130–220)	140 (100–170)
		280–380HB	160 (110–190)	160 (110–190)	100 (70–120)
	Pre-Hardened Steel	35–45HRC	120 (80–140)	120 (80–140)	90 (60–100)
High Alloy Steel	300HB	130 (90–160)	130 (90–160)	100 (70–120)	
M	Stainless Steel	≤260HB	180 (130–220)	180 (130–220)	140 (100–170)
K	Cast Iron	Tensile Strength ≤350MPa	—	170 (130–220)	140 (100–170)
	Ductile Cast Iron	Tensile Strength 360–500MPa	—	140 (100–180)	120 (80–140)
		Tensile Strength 500–800MPa	—	110 (80–140)	90 (70–110)
H	Hardened Steel	45–60HRC	—	60 (50–100)	60 (40–70)

Note 1) Cutting speeds shown in bold type are for the recommended first choice grades.

■ FEED PER TOOTH (mm/t.)

Type	Depth of Cut (mm)							
	1	2	3	4	5	6	7	8
BRP4	0.40	0.30	0.20	0.10	—	—	—	—
BRP5	0.40	0.35	0.30	0.20	0.10	—	—	—
BRP6	0.50	0.40	0.30	0.25	0.23	0.20	—	—
BRP8	0.60	0.50	0.45	0.40	0.33	0.30	0.25	0.20

ARBORS > K244
 SPARE PARTS > N001
 TECHNICAL DATA > P001

ROTATING TOOLS

DEEP SHOULDER MILLING

<MILLING FOR TITANIUM ALLOY>



VFX5

- P
- M
- K
- N
- S
- H

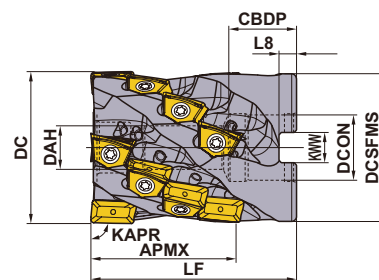

Right hand tool holder only.

K

ROTATING TOOLS

■ SHELL TYPE

KAPR :90°

Order Number	Stock	Number of Flutes	Total	Dimensions (mm)								APMX (mm)	WT* (kg)
	R			DC	LF	DCON	CBDP	DAH	DCSFMS	KWW	L8		
VFX5-040A03A026R	●	3	6	40	50	16	21	8.5	38.2	8.4	5.6	26	0.3
VFX5-040A03A038R	●	3	9	40	60	16	21	8.5	38.2	8.4	5.6	38	0.4
VFX5-050X03A026R	●	3	6	50	50	27	23	12.5	48.2	12.4	7.0	26	0.4
VFX5-050X03A038R	●	3	9	50	60	27	23	12.5	48.2	12.4	7.0	38	0.5
VFX5-050A04A026R	●	4	8	50	50	22	21	10.5	48.2	10.4	6.3	26	0.5
VFX5-050A04A038R	●	4	12	50	60	22	21	10.5	48.2	10.4	6.3	38	0.6
VFX5-050X04A038R	●	4	12	50	60	27	23	12.5	48.2	12.4	7.0	38	0.5
VFX5-050A04A050R	●	4	16	50	70	22	21	10.5	48.2	10.4	6.3	50	0.7
VFX5-063A05A026R	●	5	10	63	60	27	28	12.5	61	12.4	7.0	26	1.0
VFX5-063A05A063R	●	5	25	63	85	27	28	12.5	61	12.4	7.0	63	1.4
VFX5-080A06A075R	●	6	36	80	100	32	28	16.5	77.3	14.4	8.0	75	2.8

* WT : Tool Weight

● : Inventory maintained.

SPARE PARTS

Order Number	*2		Seal Washer	Wrench	*3			Set Bolt	Number of Insert	
	Clamp Screw	Number			Coolant Nozzle	Number	Anti-seize Lubricant		End Cutting Edge	Peripheral*1 Cutting Edge
									XNMU1607 ○R○	XNMU1607 08R○
VFX5-040A03A026R	TS352	6	W8-S1	TKY10D	HSD04004H08	9	MK1KS	HSC08040	3	3
VFX5-040A03A038R	TS352	9	W8-S1	TKY10D	HSD04004H08	12	MK1KS	HSC08050	3	6
VFX5-050X03A026R	TS352	6	W12-S1	TKY10D	HSD04004H08	9	MK1KS	HSC12035	3	3
VFX5-050X03A038R	TS352	9	W12-S1	TKY10D	HSD04004H08	12	MK1KS	HSC12045	3	6
VFX5-050A04A026R	TS352	8	W10-S1	TKY10D	HSD04004H08	12	MK1KS	HSC10035	4	4
VFX5-050A04A038R	TS352	12	W10-S1	TKY10D	HSD04004H08	16	MK1KS	HSC10045	4	8
VFX5-050X04A038R	TS352	12	W12-S1	TKY10D	HSD04004H08	16	MK1KS	HSC12045	4	8
VFX5-050A04A050R	TS352	16	W10-S1	TKY10D	HSD04004H08	20	MK1KS	HSC10055	4	12
VFX5-063A05A026R	TS352	10	W12-S1	TKY10D	HSD04004H08	15	MK1KS	HSC12045	5	5
VFX5-063A05A063R	TS352	25	W12-S1	TKY10D	HSD04004H08	30	MK1KS	HSC12070	5	20
VFX5-080A06A075R	TS352	36	W16-S1	TKY10D	HSD04004H08	42	MK1KS	HSC16080	6	30

*1 Only corner radius R0.8 can be used for the peripheral cutting edges except the end cutting edge.

*2 Clamp Torque (N · m) : TS352=2.5

*3 Coolant nozzles are available with varying diameters for adjusting coolant pressure. Select nozzles as required by the specification.

	≤1Mpa (≤20 l/min.)	←Standard→	≥5Mpa (≥30 l/min.)	≥7Mpa (≥50 l/min.)
Nozzle Dia.	ø0.6mm	ø0.8mm	ø1.2mm	ø1.6mm
Order Number	HSD04004H06	HSD04004H08	HSD04004H12	HSD04004H16

* Clamp Torque (N · m) : HSD0400H○=1.5

*4 The part number for a blank screw without a through nozzle is HSS04004.

*5 Note for insert with a corner radius of 3.2 and above, as corner radius increases the LF dimension increases.





Corner radius 3.2: LF+0.7mm Corner radius 4.0: LF+1.5mm

K

ROTATING TOOLS

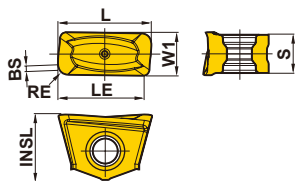
ROTATING TOOLS

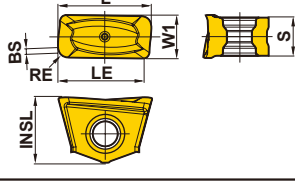
INSERTS

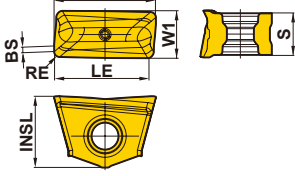
Work Material	S	Heat-resistant Alloy, Titanium Alloy	✦	Cutting Conditions (Guide) :								Geometry
				● : Stable Cutting ● : General Cutting ✦ : Unstable Cutting								
Shape	Order Number	Stock		Dimensions (mm)								
		Coated	MP9130	L	LE	W1	INSL	S	BS	RE		
General Purpose 	XNMU160708R-MS	●		16.0	13.4	7.0	11.1	6.5	1.0	0.8		
	XNMU160712R-MS	●		16.0	13.8	7.0	11.1	6.5	1.0	1.2		
	XNMU160716R-MS	●		16.0	13.8	7.0	11.1	6.5	1.0	1.6		
	XNMU160724R-MS	●		16.0	13.8	7.0	11.1	6.5	1.0	2.4		
	*1 XNMU160732R-MS	●		17.3	14.4	7.0	11.1	6.5	—	3.2		
	*1 XNMU160740R-MS	●		18.9	15.2	7.0	11.1	6.5	—	4.0		
Cutting Edge Enhancement Type 	XNMU160708R-HS	●		16.0	13.4	7.0	11.1	6.5	1.0	0.8		
Chip Processing Type 	XNMU160708R-LS	●		16.0	13.4	7.0	11.1	6.5	1.0	0.8		

*1 Note for insert with a corner radius of 3.2 and above, as corner radius increases the LF dimension increases.

Corner radius 3.2: LF+0.7mm Corner radius 4.0: LF+1.5mm

K

ROTATING TOOLS

● : Inventory maintained.

(10 inserts in one case)

RECOMMENDED CUTTING CONDITIONS

■ VFX5

Work Material	Cutting Edge Diameter (mm)	Number of Flutes	Recommended Insert	Cutting Speed Vc (m/min)	Revolution n (min ⁻¹)	Depth of Cut APMX (mm)	Cutting Width ae (mm)	Feed per Tooth fz (mm/t.)	Table Feed Vf (mm/min)	Chip Removal Rate Q (cm ³ /min)	Estimated Cutting Power (kW)	Expected Torque (Nm)	Tool Life Ratio (%)	
S Titanium Alloy (Ti-6Al-4V)	φ40	3	LS	40	318	38	40	0.10	95	145	6.5	194	40	
		3	MS	50	398	38	24	0.10	119	109	4.5	109	60	
		3	MS	60	477	38	16	0.10	143	87	3.5	69	80	
		3	HS	60	477	38	8	0.12	172	52	2.3	45	100	
	φ50	3	LS	40	255	38	50	0.10	76	145	6.5	242	40	
		4	MS	50	318	50	30	0.10	127	191	7.9	237	60	
		4	MS	60	382	50	20	0.10	153	153	6.0	151	80	
		4	HS	60	382	50	10	0.12	183	92	3.9	98	100	
	φ63	5	LS	40	202	60	63	0.10	101	382	16.8	793	40	
		5	MS	50	253	60	38	0.10	126	286	11.8	447	60	
		5	MS	60	303	60	25	0.10	152	229	9.0	285	80	
		5	HS	60	303	60	13	0.12	182	138	5.9	185	100	
	φ80	6	LS	40	159	75	80	0.10	95	573	25.0	1500	40	
		6	MS	50	199	75	48	0.10	119	430	17.6	846	60	
		6	MS	60	239	75	32	0.10	143	344	13.5	539	80	
		6	HS	60	239	75	16	0.12	172	206	8.7	350	100	
	Titanium Alloy (Ti-5Al-5V-5Mo-3Cr)	φ40	3	LS	25	199	38	40	0.08	48	73	3.4	161	30
			3	MS	25	199	38	24	0.08	48	44	1.9	92	50
			3	MS	30	239	38	16	0.10	72	44	1.8	74	70
			3	HS	30	239	38	8	0.10	72	22	1.0	41	90
		φ50	4	LS	25	159	50	50	0.08	51	127	5.8	350	30
			4	MS	25	159	50	30	0.08	51	76	3.4	201	50
			4	MS	30	191	50	20	0.10	76	76	3.2	160	70
			4	HS	30	191	50	10	0.10	76	38	1.8	89	90
φ63		5	LS	25	126	60	63	0.08	51	191	8.7	658	30	
		5	MS	25	126	60	38	0.08	51	115	5.0	378	50	
		5	MS	30	152	60	25	0.10	76	115	4.8	301	70	
		5	HS	30	152	60	13	0.10	76	57	2.6	167	90	
φ80		6	LS	25	99	75	80	0.08	48	286	13.0	1246	30	
		6	MS	25	99	75	48	0.08	48	172	7.5	716	50	
		6	MS	30	119	75	32	0.10	72	172	7.1	570	70	
		6	HS	30	119	75	16	0.10	72	86	3.9	316	90	

Note 1) Please note that machining performance varies depending to the conditions such as machine rigidity, work clamping rigidity, coolant supply system, pressure and flow volume etc.

Note 2) Internal coolant is recommended. Please use an FMH type arbor for through coolant. Using external coolant in combination with through coolant is even more effective.

Note 3) The maximum depth of cut (apmx) varies according to the machine rigidity and power.

K

ROTATING TOOLS

ROTATING TOOLS

DEEP SHOULDER MILLING

<MILLING FOR TITANIUM ALLOY>



VFX6

- P
- M
- K
- N
- S
- H

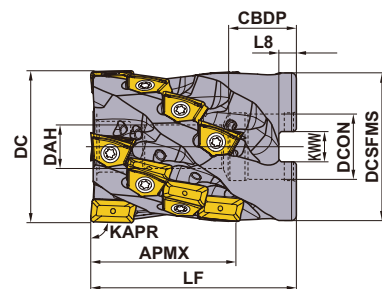

Right hand tool holder only.

K

ROTATING TOOLS

■ SHELL TYPE

KAPR :90°

Order Number	Stock		Total	Dimensions (mm)								APMX (mm)	WT* (kg)
	R	Number of Flutes		DC	LF	DCON	CBDP	DAH	DCSFMS	KWW	L8		
VFX6-063A04A031R	●	4	8	63	60	27	28	12.5	61	12.4	7	31	0.9
VFX6-063A04A060R	●	4	16	63	85	27	28	12.5	61	12.4	7	60	1.3
VFX6-080A05A031R	●	5	10	80	60	32	28	16.5	77.3	14.4	8	31	1.5
VFX6-080A05A075R	●	5	25	80	100	32	28	16.5	77.3	14.4	8	75	2.6
VFX6-100A06A031R	●	6	12	100	65	40	30	20.5	96.6	16.4	9	31	2.7
VFX6-100A06A090R	●	6	36	100	115	40	30	20.5	96.6	16.4	9	90	4.8

* WT : Tool Weight

● : Inventory maintained.

SPARE PARTS

Order Number	*2		Seal Washer	Wrench	*3		Anti-seize Lubricant	Set Bolt	Number of Insert	
	Clamp Screw	Number			Coolant Nozzle	Number			End Cutting Edge	Peripheral *1 Cutting Edge
									XNMU1909 ○○R○○	XNMU1909 12R-○○
VFX6-063A04A031R	TS450	8	W12-S1	TKY20T	HSD04004H08	12	MK1KS	HSC12045	4	4
VFX6-063A04A060R	TS450	16	W12-S1	TKY20T	HSD04004H08	20	MK1KS	HSC12070	4	12
VFX6-080A05A031R	TS450	10	W16-S1	TKY20T	HSD04004H08	15	MK1KS	HSC16040	5	5
VFX6-080A05A075R	TS450	25	W16-S1	TKY20T	HSD04004H08	30	MK1KS	HSC16080	5	20
VFX6-100A06A031R	TS450	12	W20-S1	TKY20T	HSD04004H08	18	MK1KS	HSC20040	6	6
VFX6-100A06A090R	TS450	36	W20-S1	TKY20T	HSD04004H08	42	MK1KS	HSC20090	6	30

*1 Only corner radius R1.2 can be used for the peripheral cutting edges except the end cutting edge.

*2 Clamp Torque (N · m) : TS450=5.0

*3 Coolant nozzles are available with varying diameters for adjusting coolant pressure. Select nozzles as required by the specification.

	≤1Mpa (≤20 l/min.)	←Standard→	≥5Mpa (≥30 l/min.)	≥7Mpa (≥50 l/min.)
Nozzle Dia.	ø0.6mm	ø0.8mm	ø1.2mm	ø1.6mm
Order Number	HSD04004H06	HSD04004H08	HSD04004H12	HSD04004H16

* Clamp Torque (N · m) : HSD0400H○○=1.5

*4 The part number for a blank screw without a through nozzle is HSS04004.

*5 Note for insert with a corner radius of 3.2 and above, as corner radius increases the LF dimension increases.





Corner radius 3.2: LF+0.7mm Corner radius 4.0: LF+1.5mm Corner radius 5.0: LF+1.5mm

K

ROTATING TOOLS

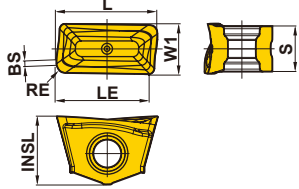
ROTATING TOOLS

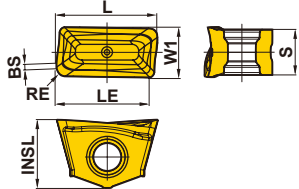
INSERTS

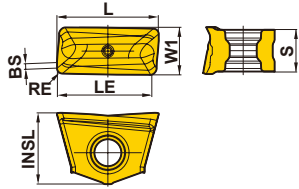
Work Material	S	Heat-resistant Alloy, Titanium Alloy	✦	Cutting Conditions (Guide) :								Geometry
				● : Stable Cutting ● : General Cutting ✦ : Unstable Cutting								
Shape	Order Number	Stock		Dimensions (mm)								
		Coated	MP9130	L	LE	W1	INSL	S	BS	RE		
General Purpose 	XNMU190912R-MS	●		19.1	16.5	9.5	12.7	8.5	1.0	1.2		
	XNMU190916R-MS	●		19.1	16.5	9.5	12.7	8.5	1.0	1.6		
	XNMU190924R-MS	●		19.1	16.6	9.5	12.7	8.5	1.0	2.4		
	*1 XNMU190932R-MS	●		20.2	17.1	9.5	12.7	8.5	—	3.2		
	*1 XNMU190940R-MS	●		21.8	17.8	9.5	12.7	8.5	—	4.0		
	*1 XNMU190950R-MS	●		21.8	17.8	9.5	12.7	8.5	—	5.0		
Cutting Edge Enhancement Type 	XNMU190912R-HS	●		19.1	16.5	9.5	12.7	8.5	1.0	1.2		
Chip Processing Type 	XNMU190912R-LS	●		19.1	16.5	9.5	12.7	8.5	1.0	1.2		

*1 Note for insert with a corner radius of 3.2 and above, as corner radius increases the LF dimension increases.

Corner radius 3.2: LF+0.7mm Corner radius 4.0: LF+1.5mm Corner radius 5.0: LF+1.5mm

K

ROTATING TOOLS

RECOMMENDED CUTTING CONDITIONS

■ VFX6

Work Material	Cutting Edge Diameter (mm)	Number of Flutes	Recommended Insert	Cutting Speed Vc (m/min)	Revolution n (min ⁻¹)	Depth of Cut APMX (mm)	Cutting Width ae (mm)	Feed per Tooth fz (mm/t.)	Table Feed Vf (mm/min)	Chip Removal Rate Q (cm ³ /min)	Estimated Cutting Power (kW)	Expected Torque (Nm)	Tool Life Ratio (%)	
S Titanium Alloy (Ti-6Al-4V)	φ63	4	LS	40	202	60	63	0.10	81	306	13.4	634	40	
		4	MS	50	253	60	38	0.10	101	229	9.5	357	60	
		4	MS	60	303	60	25	0.10	121	183	7.2	228	80	
		4	HS	60	303	60	13	0.12	146	110	4.7	148	100	
	φ80	5	LS	40	159	75	80	0.10	80	477	20.8	1250	40	
		5	MS	50	199	75	48	0.10	99	358	14.7	705	60	
		5	MS	60	239	75	32	0.10	119	286	11.2	449	80	
		5	HS	60	239	75	16	0.12	143	172	7.3	291	100	
	φ100	6	LS	40	127	90	100	0.10	76	688	29.6	2218	40	
		6	MS	50	159	90	60	0.10	95	516	20.9	1252	60	
		6	MS	60	191	90	40	0.10	115	413	16.0	798	80	
		6	HS	60	191	90	20	0.12	138	248	10.3	517	100	
	Titanium Alloy (Ti-5Al-5V-5Mo-3Cr)	φ63	4	LS	25	126	60	63	0.08	40	153	7.0	527	30
			4	MS	25	126	60	38	0.08	40	92	4.0	303	50
			4	MS	30	152	60	25	0.10	61	92	3.8	241	70
			4	HS	30	152	60	13	0.10	61	46	2.1	133	80
φ80		5	LS	25	99	75	80	0.08	40	239	10.8	1038	30	
		5	MS	25	99	75	48	0.08	40	143	6.2	597	50	
		5	MS	30	119	75	32	0.10	60	143	5.9	475	70	
		5	HS	30	119	75	16	0.10	60	72	3.3	263	80	
φ100		6	LS	25	80	90	100	0.08	38	344	15.3	1841	30	
		6	MS	25	80	90	60	0.08	38	206	8.8	1059	50	
		6	MS	30	95	90	40	0.10	57	206	8.4	844	70	
		6	HS	30	95	90	20	0.10	57	103	4.7	466	80	

Note 1) Please note that machining performance varies depending on the conditions such as machine rigidity, work clamping rigidity, coolant supply system, pressure and flow volume etc.

Note 2) Internal coolant is recommended. Please use an FMH type arbor for through coolant. Using external coolant in combination with through coolant is even more effective.

Note 3) The maximum depth of cut (apmx) varies according to the machine rigidity and power.

K

ROTATING TOOLS

ROTATING TOOLS

DEEP SHOULDER MILLING

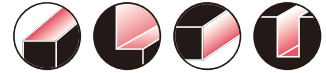

DCCC

- P
- M
- K
- N
- S
- H

K

ROTATING TOOLS



DESIGN FEATURES OF DCCC TYPE END MILL

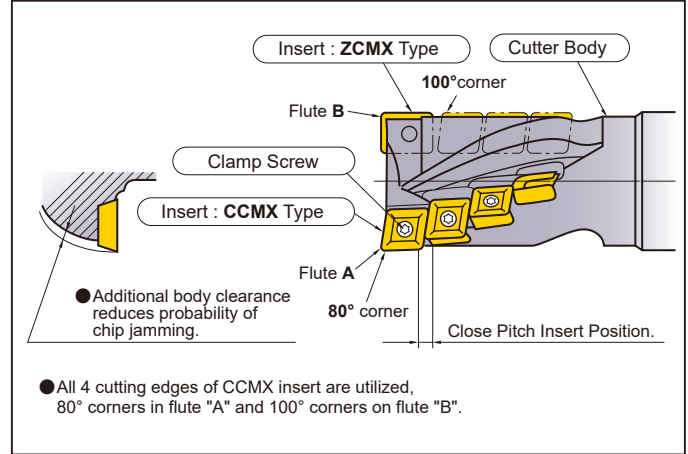

● φ25 2 flute

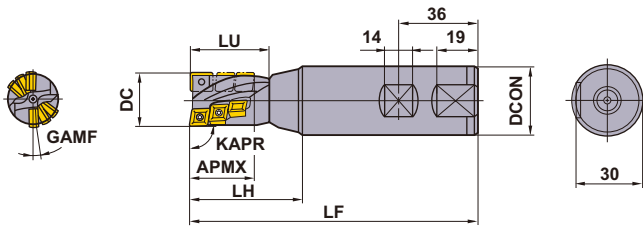

● φ32 2 flute

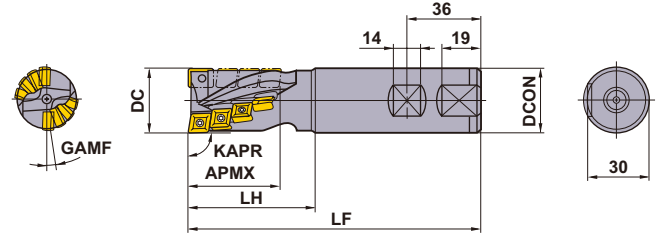

● φ40 3 flute

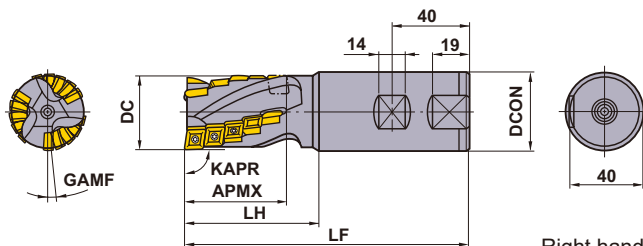

Right hand tool holder only.

WELDON SHANK TYPE



KAPR : 90°

DC (mm)	Order Number	Stock	Dimensions (mm)					GAMF	WT* (kg)	Number of Teeth		Peripheral and Bottom		Bottom insert only	
			LF	DCON	LH	LU	APMX			Bottom	Total	Type	Number of Teeth	Type	Number of Teeth
25	DCCCR2506S32	●	130	32	50	36	27	8°	0.6	2	6	CCMX08	5	ZCMX08	1
25	DCCCR2510S32	●	150	32	70	56	44	8°	0.7	2	10	CCMX08	9	ZCMX08	1
32	DCCCR3208S32	●	140	32	60	—	43	8°36'	0.8	2	8	CCMX09	7	ZCMX09	1
32	DCCCR3212S32	●	160	32	80	—	63	8°36'	0.8	2	12	CCMX09	11	ZCMX09	1
40	DCCCR4015S40	●	150	40	70	—	53	5°31'	1.3	3	15	CCMX09	14	ZCMX09	1
40	DCCCR4015S42	★	150	42	70	—	53	5°31'	1.3	3	15	CCMX09	14	ZCMX09	1
40	DCCCR4024S40	●	180	40	100	—	83	5°31'	1.4	3	24	CCMX09	23	ZCMX09	1
40	DCCCR4024S42	★	180	42	100	—	83	5°31'	1.4	3	24	CCMX09	23	ZCMX09	1

* WT : Tool Weight





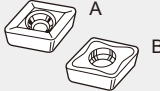
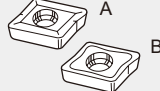





















● : Inventory maintained. ★ : Inventory maintained in Japan.
(10 inserts in one case)

SPARE PARTS

Tool Holder Number	*				
					
	Clamp Screw	Wrench	Wrench	Insert	
				Peripheral and Bottom Insert	Bottom Insert (One Pocket Only)
DCCCR25	CS300890T	TKY08F	TKY08DS	CCMX083508EN-A	ZCMX083508ER-A
DCCCR32 DCCCR40	CS350990T	TKY10F	TKY10DS	CCMX09T308EN-A or B	ZCMX09T308ER-A or B

* Clamp Torque (N · m) : CS300890T=1.0, CS350990T=2.5

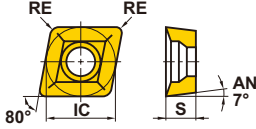
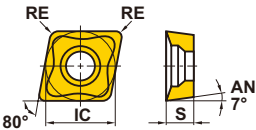
INSERTS

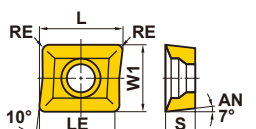
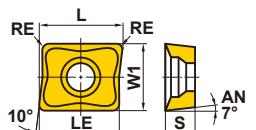
Work Material	P	Steel									Cutting Conditions (Guide) :							
	M	Stainless Steel													● : Stable Cutting	● : General Cutting	✦ : Unstable Cutting	
	K	Cast Iron												Honing : E : Round				
Shape	Order Number	Class	Honing	Coated				Carbide				Dimensions (mm)						Geometry
				F7030	VP15TF	UP20M	UT120T	L	LE	W1	IC	S	RE					
	CCMX083508EN-A	M	E	●	★	★	★	—	—	—	7.94	3.5	0.8					
	CCMX09T308EN-A	M	E	●	★	★	★	—	—	—	9.525	3.97	0.8					
Strong Cutting Edge Type	CCMX09T308EN-B	M	E	●			★	—	—	—	9.525	3.97	0.8					
	ZCMX083508ER-A	M	E	●			★	11.0	8.5	7.94	—	3.5	0.8					
	ZCMX09T308ER-A	M	E	●	●	●	★	12.7	11.0	9.525	—	3.97	0.8					
Strong Cutting Edge Type	ZCMX09T308ER-B	M	E	●	★			12.7	11.0	9.525	—	3.97	0.8					

K

ROTATING TOOLS

RECOMMENDED CUTTING CONDITIONS

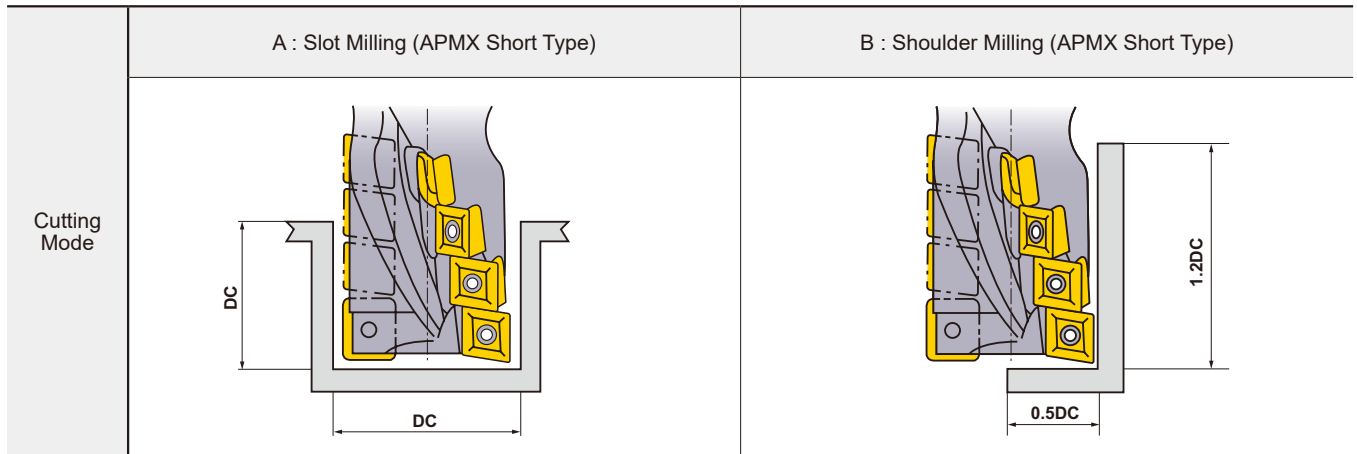

Work Material	Hardness	Grade	Cutting Mode	Cutting Speed (m/min)	Table Feed (mm/min)		
					φ25	φ32	φ40
P Mild Steel	≤180HB	F7030	A	200 (160–240)	120 (100–140)	120 (100–140)	120 (100–140)
		F7030	B	200 (160–240)	200 (180–220)	200 (180–220)	230 (200–250)
Carbon Steel Alloy Steel	180–280HB	F7030	A	160 (130–180)	120 (100–140)	120 (100–140)	140 (120–150)
		F7030	B	160 (130–180)	150 (120–180)	150 (120–180)	180 (150–200)
	280–350HB	F7030	A	160 (130–180)	100 (80–120)	100 (80–120)	130 (100–150)
		F7030	B	160 (130–180)	120 (100–140)	120 (100–140)	150 (120–180)
M Stainless Steel	≤200HB	F7030	A	80 (60–100)	70 (50–90)	70 (50–90)	70 (50–90)
		F7030	B	130 (100–160)	100 (80–120)	100 (80–120)	120 (100–140)
K Cast Iron	Tensile Strength ≤450MPa	UT120T	A	120 (100–140)	200 (180–220)	200 (180–220)	230 (200–250)
		UT120T	B	120 (100–140)	230 (200–250)	230 (200–250)	260 (240–280)

- Revolution (min⁻¹)=(1000 x Cutting Speed)÷(3.14 x DC)
- Table Feed (mm/min)=Feed per Tooth x Number of Teeth x Cutter Revolution

POWER CONSUMPTION

- Please use the chart below for reference, please select the conditions that suits the machines power.
- Chip Discharge Q (cm³/min.)=Table Feed x Depth of Cut x Cutting Width÷1000

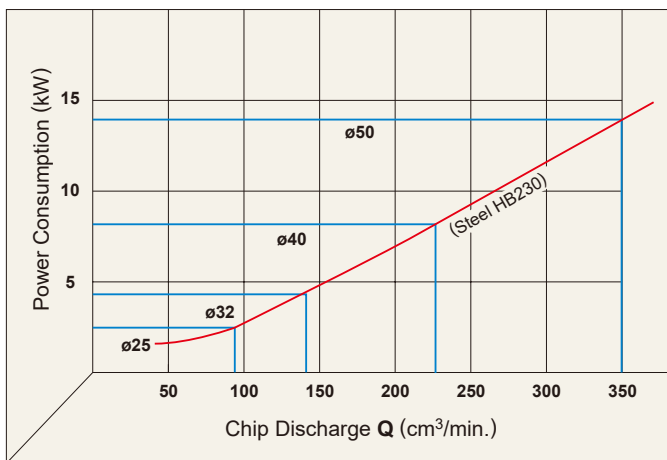

FOR USE OF APMX LONG TYPE

- When the overhang from the milling chuck is long, a large width of cut will cause chattering and tool breakage.
- Keep the width of cut small and the depth of cut in axial direction large. (See the following illustration.)
- For slot milling, keep the table feed at not more than half the value listed in the above table. (Use the APMX Short type as much as possible.)

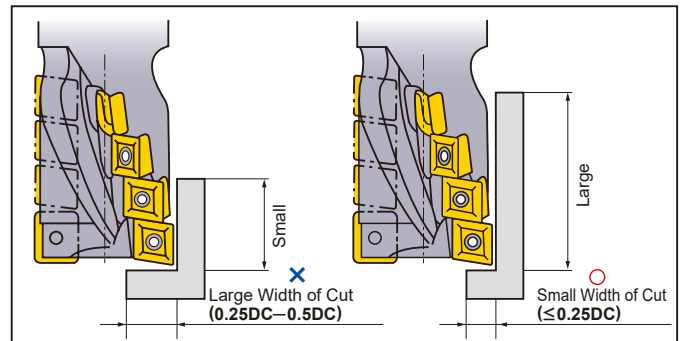

DEEP SHOULDER MILLING



SPX

- P
- M
- K
- N
- S
- H



● SK50 shank type

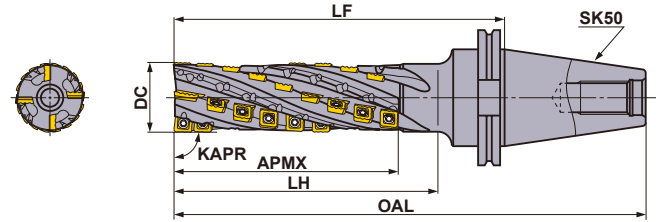

KAPR :90°

Order Number	Stock	Number of Teeth			Dimensions (mm)					Number of Insert		
		Flutes	Total	Bottom	DC	OAL	LH	LF	APMX	Bottom On-edge A	Bottom On-edge B	Peripheral
										JPMX 190412-○○	MPMX 120412-○○	SPMX 120408-○○
SPX4R06324SK50NS	<input type="checkbox"/>	2	24	4	63	289.6	140	188	110	2	2	20
SPX4R06334SK50NM	<input type="checkbox"/>	2	34	4	63	339.6	190	238	157	2	2	30
SPX4R06344SK50NL	<input type="checkbox"/>	2	44	4	63	389.6	240	288	205	2	2	40
SPX4R06356SK50NX	<input type="checkbox"/>	2	56	4	63	439.6	290	338	261	2	2	52

K
ROTATING TOOLS

: Non stock, produced to order only.

SPARE PARTS > N001
TECHNICAL DATA > P001

ROTATING TOOLS

K

ROTATING TOOLS

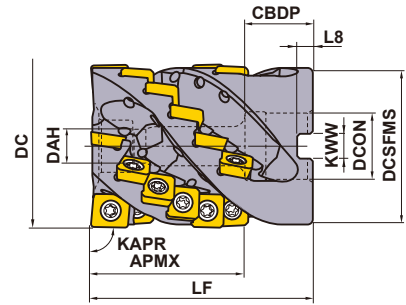
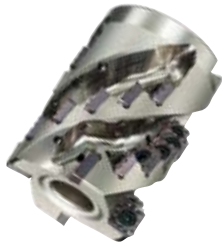

Right hand tool holder only.

Cutter Diameter DC (mm)	Set Bolt	Geometry
φ63	HSC12070	
φ80	HSC16065	

■ SHELL TYPE

KAPR :90°

Order Number	Stock R	Number of Teeth		Dimensions (mm)									Number of Insert		
		Flutes	Total	DC	LF	DCON	CBDP	DAH	DCSFMS	KWW	L8	APMX	Bottom On-edge		
													A	B	Peripheral
SPX4-063A24A058RA	●	4	24	63	85	27	28	13	60	12.4	7	58	JPMX 140412-○○	MPMX 120412-○○	SPMX 120408-○○
SPX4-080A24A058RA	★	4	24	80	85	32	40	17	76.8	14.4	8	58	2	2	20

Note 1) In case of internal coolant supply, please use a face mill arbor with through coolant channels. Regular center-thru or side-thru arbors can't be used.

SPARE PARTS

Tool Holder Number						
	Clamp Screw	Wrench	Anti-seize Lubricant	Insert		
				Bottom On-edge A	Bottom On-edge B	Peripheral
SPX	TS55	TKY25D	MK1KS	JPMX140412-WH	MPMX120412-WH	SPMX120408-WH
				JPMX140412-JM	MPMX120412-JM	SPMX120408-JM

* Clamp Torque (N • m) : TS55=7.5

● : Inventory maintained. ★ : Inventory maintained in Japan.
(10 inserts in one case)

INSERTS

Work Material		P	Steel	●	●	Cutting Conditions (Guide) : ● : Stable Cutting ● : General Cutting ✦ : Unstable Cutting						
		M	Stainless Steel	●	●							
K	Cast Iron	✦	✦									
S	Heat-resistant Alloy, Titanium Alloy	✦	✦									
Type	Shape	Order Number	Class	Coated		Dimensions (mm)						Geometry
				VP15TF	VP20RT	L	LE	W1	IC	S	RE	
Wavy cutting edge type (WH Breaker)	Bottom On-edge A	JPMX190412-WH	M	●	●	19.81	17.6	12.7	—	4.76	1.2	
		* JPMX140412-WH	M	●	●	15.04	12.9	12.7	—	4.76	1.2	
	Bottom On-edge B	MPMX120412-WH	M	●	●	—	—	—	12.7	4.76	1.2	
Wavy cutting edge type (WH Breaker)	Peripheral	SPMX120408-WH	M	●	●	—	—	—	12.7	4.76	0.8	
	Bottom On-edge A	JPMX190412-JM	M	●	●	19.81	17.6	12.7	—	4.83	1.2	
* JPMX140412-JM	M	●	●	15.04	12.9	12.7	—	4.79	1.2			
Straight cutting edge type (JM Breaker)	Bottom On-edge B	MPMX120412-JM	M	●	●	—	—	—	12.7	4.79	1.2	
	Peripheral	SPMX120408-JM	M	●	●	—	—	—	12.7	4.80	0.8	

* Only for use with a shell type holder.

K

ROTATING TOOLS

ROTATING TOOLS

RECOMMENDED CUTTING CONDITIONS (SHANK TYPE)

CUTTING CONDITIONS FOR SHOULDER MILLING

Work Material	Hardness	Grade Breaker	Cutting Speed V_c (m/min)	Cutting Width : a_e (mm) Feed per Tooth : f_z (mm/t.)								
				$\phi 50$ (the last letter of order number for cutter body)			$\phi 63$ (the last letter of order number for cutter body)					
				S (APMX \leq 110)	M (APMX=157)	L (APMX=205)	S (APMX=110)	M (APMX=157)	L (APMX=205)	X (APMX=261)		
P Mild Steel	$\leq 180\text{HB}$	VP15TF	WH	120 (100-140)	≤ 10.0 0.15-0.25	≤ 5.0 0.15-0.25	≤ 2.5 0.10-0.20	≤ 12.5 0.15-0.25	≤ 10.0 0.15-0.25	≤ 5.0 0.15-0.25	≤ 2.5 0.10-0.20	
			JM	120 (100-140)	≤ 7.5 0.10-0.20	≤ 5.0 0.10-0.20	≤ 2.5 0.05-0.15	≤ 10.0 0.10-0.20	≤ 7.5 0.10-0.20	≤ 5.0 0.10-0.20	≤ 2.5 0.05-0.15	
	Carbon Steel Alloy Steel		180-350HB	WH	80 (70-120)	≤ 10.0 0.15-0.25	≤ 5.0 0.15-0.25	≤ 2.5 0.10-0.20	≤ 12.5 0.15-0.25	≤ 10.0 0.15-0.25	≤ 5.0 0.15-0.25	≤ 2.5 0.10-0.20
				JM	80 (70-120)	≤ 7.5 0.10-0.20	≤ 5.0 0.10-0.20	≤ 2.5 0.05-0.15	≤ 10.0 0.10-0.20	≤ 7.5 0.10-0.20	≤ 5.0 0.10-0.20	≤ 2.5 0.05-0.15
	Alloy Tool Steel	$\leq 300\text{HB}$	WH	80 (60-100)	≤ 10.0 0.10-0.20	≤ 5.0 0.10-0.20	≤ 2.5 0.05-0.15	≤ 12.5 0.10-0.20	≤ 10.0 0.10-0.20	≤ 5.0 0.10-0.20	≤ 2.5 0.05-0.15	
			JM	80 (60-100)	≤ 7.5 0.10-0.15	≤ 5.0 0.10-0.15	≤ 2.5 0.05-0.10	≤ 10.0 0.10-0.15	≤ 7.5 0.10-0.15	≤ 5.0 0.10-0.15	≤ 2.5 0.05-0.10	
M Stainless Steel	$\leq 200\text{HB}$	VP20RT	WH	80 (60-100)	≤ 7.5 0.08-0.15	≤ 5.0 0.08-0.15	≤ 2.5 0.05-0.10	≤ 10.0 0.08-0.15	≤ 7.5 0.08-0.15	≤ 5.0 0.08-0.15	≤ 2.5 0.05-0.10	
			JM	80 (60-100)	≤ 5.0 0.08-0.15	≤ 3.5 0.08-0.15	≤ 2.0 0.05-0.10	≤ 7.5 0.08-0.15	≤ 5.0 0.08-0.15	≤ 3.5 0.08-0.15	≤ 2.0 0.05-0.10	
K Gray Cast Iron	Tensile Strength $\leq 350\text{MPa}$	VP15TF	WH	100 (80-120)	≤ 10.0 0.15-0.40	≤ 5.0 0.15-0.35	≤ 2.5 0.10-0.30	≤ 12.5 0.15-0.40	≤ 10.0 0.15-0.40	≤ 5.0 0.15-0.35	≤ 2.5 0.10-0.30	
			JM	100 (80-120)	≤ 7.5 0.10-0.25	≤ 5.0 0.10-0.25	≤ 2.5 0.05-0.20	≤ 10.0 0.10-0.25	≤ 7.5 0.10-0.25	≤ 5.0 0.10-0.25	≤ 2.5 0.05-0.20	
	Ductile Cast Iron		Tensile Strength $\leq 800\text{MPa}$	WH	80 (60-100)	≤ 10.0 0.15-0.35	≤ 5.0 0.15-0.30	≤ 2.5 0.10-0.25	≤ 12.5 0.15-0.35	≤ 10.0 0.15-0.35	≤ 5.0 0.15-0.30	≤ 2.5 0.10-0.25
				JM	80 (60-100)	≤ 7.5 0.10-0.20	≤ 5.0 0.10-0.20	≤ 2.5 0.05-0.15	≤ 10.0 0.10-0.20	≤ 7.5 0.10-0.20	≤ 5.0 0.10-0.20	≤ 2.5 0.05-0.15
S Ti Alloy	$\leq 350\text{HB}$	VP20RT	WH	40 (35-50)	≤ 5.0 0.05-0.10	≤ 3.5 0.05-0.10	≤ 2.0 0.05-0.10	≤ 7.5 0.05-0.10	≤ 5.0 0.05-0.10	≤ 3.5 0.05-0.10	≤ 2.0 0.05-0.10	
			JM	40 (35-50)	≤ 3.5 0.05-0.10	≤ 2.5 0.05-0.10	≤ 1.5 0.05-0.10	≤ 5.0 0.05-0.10	≤ 3.5 0.05-0.10	≤ 2.5 0.05-0.10	≤ 1.5 0.05-0.10	

Note 1) The above cutting conditions are determined based on high rigidity machine and workpiece, where no vibration occurred. Please adjust machining conditions if vibration is generated.

Note 2) If the cutting angle between the tool and workpiece exceeds 90° when machining corners. Reduce the cutting speed and table feed by 10-20% and a_e by 50%. Also if possible, set a radius cutting path for corners.

CUTTING CONDITIONS FOR SLOT MILLING

Work Material	Hardness	Grade Breaker	Cutting Speed V_c (m/min)	Depth of Cut : a_p (mm) Feed per Tooth : f_z (mm/t.)								
				$\phi 50$ (the last letter of order number for cutter body)			$\phi 63$ (the last letter of order number for cutter body)					
				S (APMX \leq 110)	M (APMX=157)	L (APMX=205)	S (APMX=110)	M (APMX=157)	L (APMX=205)	X (APMX=261)		
P Mild Steel	$\leq 180\text{HB}$	VP15TF	WH	60 (50-120)	≤ 10.0 0.10-0.25	≤ 5.0 0.10-0.20	≤ 2.5 0.10-0.15	≤ 12.5 0.10-0.25	≤ 10.0 0.10-0.25	≤ 5.0 0.10-0.20	≤ 2.5 0.10-0.15	
			JM	60 (50-120)	≤ 7.5 0.10-0.15	≤ 5.0 0.10-0.15	≤ 2.5 0.10-0.15	≤ 10.0 0.10-0.15	≤ 7.5 0.10-0.15	≤ 5.0 0.10-0.15	≤ 2.5 0.10-0.15	
	Carbon Steel Alloy Steel		180-350HB	WH	60 (50-100)	≤ 10.0 0.10-0.25	≤ 5.0 0.10-0.20	≤ 2.5 0.10-0.15	≤ 12.5 0.10-0.25	≤ 10.0 0.10-0.25	≤ 5.0 0.10-0.20	≤ 2.5 0.10-0.15
				JM	60 (50-100)	≤ 7.5 0.10-0.15	≤ 5.0 0.10-0.15	≤ 2.5 0.10-0.15	≤ 10.0 0.10-0.15	≤ 7.5 0.10-0.15	≤ 5.0 0.10-0.15	≤ 2.5 0.10-0.15
	Alloy Tool Steel	$\leq 300\text{HB}$	WH	50 (40-80)	≤ 10.0 0.10-0.25	≤ 5.0 0.10-0.20	≤ 2.5 0.10-0.15	≤ 12.5 0.10-0.25	≤ 10.0 0.10-0.25	≤ 5.0 0.10-0.20	≤ 2.5 0.10-0.15	
			JM	50 (40-80)	≤ 7.5 0.10-0.15	≤ 5.0 0.10-0.15	≤ 2.5 0.10-0.15	≤ 10.0 0.10-0.15	≤ 7.5 0.10-0.15	≤ 5.0 0.10-0.15	≤ 2.5 0.10-0.15	
M Stainless Steel	$\leq 200\text{HB}$	VP20RT	WH	40 (35-80)	≤ 10.0 0.08-0.15	≤ 5.0 0.08-0.15	≤ 2.5 0.05-0.10	≤ 12.5 0.08-0.15	≤ 10.0 0.08-0.15	≤ 5.0 0.08-0.15	≤ 2.5 0.05-0.10	
			JM	40 (35-80)	≤ 7.5 0.08-0.15	≤ 5.0 0.08-0.15	≤ 2.5 0.05-0.10	≤ 10.0 0.08-0.15	≤ 7.5 0.08-0.15	≤ 5.0 0.08-0.15	≤ 2.5 0.05-0.10	
K Gray Cast Iron	Tensile Strength $\leq 350\text{MPa}$	VP15TF	WH	50 (40-80)	≤ 10.0 0.15-0.25	≤ 5.0 0.10-0.25	≤ 2.5 0.10-0.20	≤ 12.5 0.15-0.25	≤ 10.0 0.15-0.25	≤ 5.0 0.10-0.25	≤ 2.5 0.10-0.20	
			JM	50 (40-80)	≤ 7.5 0.10-0.20	≤ 5.0 0.10-0.20	≤ 2.5 0.10-0.20	≤ 10.0 0.10-0.20	≤ 7.5 0.10-0.20	≤ 5.0 0.10-0.20	≤ 2.5 0.10-0.20	
	Ductile Cast Iron		Tensile Strength $\leq 800\text{MPa}$	WH	40 (35-80)	≤ 10.0 0.15-0.25	≤ 5.0 0.10-0.25	≤ 2.5 0.10-0.20	≤ 12.5 0.15-0.25	≤ 10.0 0.15-0.25	≤ 5.0 0.10-0.25	≤ 2.5 0.10-0.20
				JM	40 (35-80)	≤ 7.5 0.10-0.20	≤ 5.0 0.10-0.20	≤ 2.5 0.10-0.20	≤ 10.0 0.10-0.20	≤ 7.5 0.10-0.20	≤ 5.0 0.10-0.20	≤ 2.5 0.10-0.20
S Ti Alloy	$\leq 350\text{HB}$	VP20RT	WH	35 (30-50)	≤ 5.0 0.05-0.10	≤ 3.5 0.05-0.10	≤ 2.0 0.05-0.10	≤ 7.5 0.05-0.10	≤ 5.0 0.05-0.10	≤ 3.5 0.05-0.10	≤ 2.0 0.05-0.10	
			JM	35 (30-50)	≤ 3.5 0.05-0.10	≤ 2.5 0.05-0.10	≤ 1.5 0.05-0.10	≤ 5.0 0.05-0.10	≤ 3.5 0.05-0.10	≤ 2.5 0.05-0.10	≤ 1.5 0.05-0.10	

Note 1) The above cutting conditions are determined based on high rigidity machine and workpiece, where no vibration occurred. Please adjust machining conditions if vibration is generated.

Note 2) For slotting, please use high rigidity tools such as SPX4R05016WNES/BT50NES.

RECOMMENDED CUTTING CONDITIONS (SHELL TYPE)

■ CUTTING CONDITIONS FOR SHOULDER MILLING

Work Material	Hardness	Grade Breaker	Cutting Speed V_c (m/min)	Depth of Cut a_p (mm)	Cutting Width a_e (mm)	Feed per Tooth f_z (mm/t.)
P Mild Steel	≤180HB	VP15TF JM	120 (100-140)	-0.5DC	-10	0.15-0.30
			120 (100-140)	0.5DC-	-10	0.15-0.25
	180-350HB	VP15TF JM	120 (80-130)	-0.5DC	-10	0.15-0.30
			100 (80-120)	0.5DC-	-10	0.15-0.25
Alloy Tool Steel	≤300HB	VP15TF JM	100 (60-110)	-0.5DC	-10	0.10-0.20
			80 (60-100)	0.5DC-	-10	0.10-0.15
M Stainless Steel	≤200HB	VP20RT JM	140 (100-150)	-0.5DC	-10	0.10-0.25
			120 (100-140)	0.5DC-	-10	0.10-0.20
K Gray Cast Iron	Tensile Strength ≤350MPa	VP15TF WH	120 (80-130)	-0.5DC	-10	0.25-0.40
			100 (80-120)	0.5DC-	-10	0.25-0.40
		VP15TF JM	120 (80-130)	-0.5DC	-10	0.15-0.30
			100 (80-120)	0.5DC-	-10	0.15-0.25
Ductile Cast Iron	Tensile Strength ≤800MPa	VP15TF WH	100 (60-110)	-0.5DC	-10	0.20-0.35
			80 (60-110)	0.5DC-	-10	0.20-0.35
		VP15TF JM	100 (60-120)	-0.5DC	-10	0.15-0.30
			80 (60-120)	0.5DC-	-10	0.15-0.30
S Ti Alloy	≤350HB	VP20RT JM	45 (35-50)	-0.5DC	-10	0.08-0.10
			40 (35-50)	0.5DC-	-10	0.08-0.10

Note 1) The above cutting conditions are determined based on high rigidity machine and workpiece, where no vibration occurred. Please adjust machining conditions if vibration is generated.

■ CUTTING CONDITIONS FOR SLOT MILLING

Work Material	Hardness	Grade Breaker	Cutting Speed V_c (m/min)	Depth of Cut a_p (mm)	Cutting Width a_e (mm)	Feed per Tooth f_z (mm/t.)
P Mild Steel	≤180HB	VP15TF JM	120 (100-140)	-10	DC	0.15-0.25
	180-350HB	VP15TF JM	100 (80-120)	-0.25DC	DC	0.15-0.25
			80 (60-100)	-10	DC	0.10-0.20
M Stainless Steel	≤200HB	VP20RT JM	100 (80-140)	-10	DC	0.10-0.15
K Gray Cast Iron	Tensile Strength ≤350MPa	VP15TF WH	80 (60-100)	-0.25DC	DC	0.10-0.25
			60 (50-100)	-0.6DC	DC	0.10-0.20
		VP15TF JM	80 (60-100)	-0.25DC	DC	0.10-0.20
			60 (50-100)	-0.6DC	DC	0.10-0.15
Ductile Cast Iron	Tensile Strength ≤800MPa	VP15TF WH	80 (60-100)	-0.25DC	DC	0.10-0.25
			60 (50-100)	-0.5DC	DC	0.10-0.20
		VP15TF JM	80 (60-100)	-0.25DC	DC	0.10-0.20
			60 (50-100)	-0.5DC	DC	0.10-0.15
S Ti Alloy	≤350HB	VP20RT JM	40 (35-50)	-0.25DC	DC	0.06-0.10

Note 1) The above cutting conditions are determined based on high rigidity machine and workpiece, where no vibration occurred. Please adjust machining conditions if vibration is generated.

K

ROTATING TOOLS

ROTATING TOOLS

DEEP SHOULDER MILLING

<CUTTING FOR TITANIUM ALLOY>



ASPX

NEW

P

M

K

N

S

H

K

ROTATING TOOLS

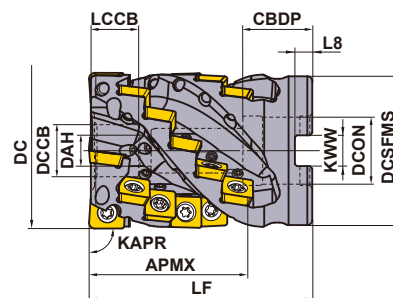

Right hand tool holder only.

Cutter Diameter DC (mm)	Set Bolt	Geometry
φ50	HSC10070	
φ63	HSC12070	
φ80	HSC16080	

SHELL TYPE

KAPR: 90°

With Coolant Hole : Shell type should be combined with a through coolant arbor.

DC (mm)	Order Number	Stock R	Number of Flutes	Total	Dimensions (mm)		WT (kg)	APMX (mm)
					LF	DCON		
50	ASPX4-050A03A054RA15	●	3	15	85	22	0.6	54
63	ASPX4-063A04A064RA24	●	4	24	90	27	1.0	64
80	ASPX4-080A05A075RA35	●	5	35	100	32	2.0	75

MOUNTING DIMENSIONS

DC (mm)	Order Number	Dimensions (mm)							
		DCON	CBDP	DAH	DCCB	LCCB	DCSFMS	KWW	L8
50	ASPX4-050A03A054RA15	22	21	10.5	17	14	47	10.4	6.3
63	ASPX4-063A04A064RA24	27	28	12.5	21	19	60	12.4	7
80	ASPX4-080A05A075RA35	32	28	16.5	27	20	76	14.4	8

SPARE PARTS

Tool Holder Type	* (Inventory maintained in Japan)						Number of Insert	
	Clamp Screw	Seal Washer	Wrench	Coolant Nozzle	Number	Anti-seize Lubricant	JPGX	SPGX
ASPX4-050A	TS55	W10-S1	TKY25D	HSD04004H08	18	MK1KS	3	12
ASPX4-063A	TS55	W12-S1	TKY25D	HSD04004H08	28	MK1KS	4	20
ASPX4-080A	TS55	W16-S1	TKY25D	HSD04004H08	40	MK1KS	5	30

* Clamp Torque (N · m) : TS55 = 5.0

	≤1Mpa (≤20 l/min.)	←Standard→	≥5Mpa (≥30 l/min.)	≥7Mpa (≥50 l/min.)	To Plug a Coolant Hole
Nozzle Dia.	φ0.6mm	φ0.8mm	φ1.2mm	φ1.6mm	—
Order Number	HSD04004H06	HSD04004H08	HSD04004H12	HSD04004H16	HSS04004

Note 1) Coolant nozzles are available with varying diameters for adjusting coolant pressure.

Select the correct nozzle according to the specification.

Note 2) Use HSS04004 (JIS B 1177 flat point M4x4, clamp torque 1.5 Nm) to plug the coolant hole.

● : Inventory maintained. ★ : Inventory maintained in Japan.

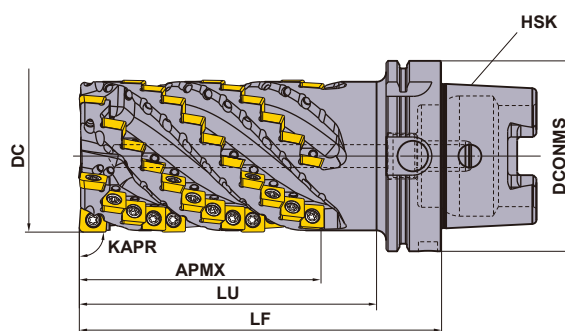

The standard type is right-handed (R) only.
The HSK shank type has a built-in movable coolant pipe for installation.

K





ROTATING TOOLS

■ HSK SHANK TYPE

KAPR: 90°
With Coolant Hole

DC	Order Number	Stock R	Number of Flutes	Total	Dimensions (mm)			HSK	APMX (mm)
					LF	LU	DCONMS		
80	ASPX4R0805H100A127SA	★	5	60	190	156	100	HSK-A100	127
80	ASPX4R0805H125A127SA	★	5	60	190	156	125	HSK-A125	127

SPARE PARTS

Tool Holder Type	* 								Number of Insert	
	Clamp Screw		Wrench		Coolant Nozzle	Number	Anti-seize Lubricant	JPGX	SPGX	
ASPX4R0805H100A	TS55		TKY25D		HSD04004H08	65	MK1KS	5	55	
ASPX4R0805H125A	TS55		TKY25D		HSD04004H08	65	MK1KS	5	55	



* Clamp Torque (N · m) : TS55 = 5.0

ROTATING TOOLS

INSERTS

K

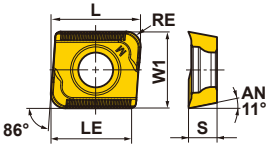
ROTATING TOOLS

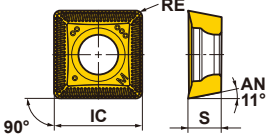
Work Material		S	Heat-resistant Alloy, Titanium Alloy	Cutting Conditions (Guide) :										
				● : Stable Cutting ● : General Cutting ✦ : Unstable Cutting Honing : E : Round										
Shape	Order Number	Class	Honing	Coated				Dimensions (mm)						Geometry
				MP9140				L	LE	W1	IC	S	RE	
Bottom  2 Corner	JPGX1404080PPER-JM	G	E	●				15.12	13.4	12.7	—	4.8	0.8	
	JPGX1404120PPER-JM	G	E	●				15.06	13.3	12.7	—	4.8	1.2	
	JPGX1404160PPER-JM	G	E	●				15.00	13.3	12.7	—	4.8	1.6	
	JPGX1404240PPER-JM	G	E	●				14.88	13.2	12.7	—	4.8	2.4	
	JPGX1404320PPER-JM	G	E	●				14.72	13.1	12.7	—	4.8	3.2	
	JPGX1404400PPER-JM	G	E	●				14.64	13.0	12.7	—	4.8	4.0	
	JPGX1404500PPER-JM	G	E	●				14.49	13.0	12.7	—	4.8	5.0	
	JPGX1404635PPER-JM	G	E	●				14.29	12.9	12.7	—	4.8	6.35	
Peripheral  4 Corner	SPGX1204100PPER-JM	G	E	●				—	—	—	12.7	4.8	1.0	

RECOMMENDED CUTTING CONDITIONS

Work Material	Cutting Width ae (mm)	Cutting Speed Vc (m/min)	Feed per Tooth fz (mm/t.)
S Ti Alloys Ti-6Al-4V, Ti-6Al-4V-ELI Ti-10V-2Fe-3Al Ti-5Al-5V-5Mo-3Cr etc.	ae ≤ 0.5DC	60(50—80)	0.12(0.10—0.14)
	0.5DC < ae < 0.8DC	50(40—60)	0.10(0.08—0.12)
	ae ≥ 0.8DC	40(50—60)	0.08(0.06—0.10)

Note 1) The cutting performance depends on machine and clamping rigidity, as well as the supply and pressure of the coolant. Adjust as necessary.

Note 2) Use a machine and spindle size suitable for heavy machining of titanium alloys. (7/24 taper #50 or #60, or high rigidity HSK-A100 or A125, with an output of 15kW or higher and torque of 500 Nm or higher for a rotation speed of 500min-1 or less).

Caution, at high load cutting conditions the output power of the machine spindle may be exceeded.

Note 3) If chatter and vibration or machine overloading occur, it is recommended to reduce the depth of cut ap.

Note 4) The coolant system combines internal and external lubrication, it is recommended to supply coolant in ample quantities.

Note 5) A gradual roll feed into the workpiece and use of down cutting (climb milling) is recommended. (refer to page K211)

● : Inventory maintained.

(10 inserts in one case)

How to Use

Positive Effects of a Roll Into Cutting Approach

The roll into cutting approach can control sharp increases in cutting loads and prevent sudden chipping of inserts which is likely to occur at the start of machining.

Approach Method	Cutting Load Simulation	Cutting Vibration Frequency
<p>Direct Approach</p> <p>Exit chips are thick.</p>	<p>Cutting load increases suddenly. High risk of chipping.</p>	<p>Primary mode</p> <p>Acceleration</p> <p>High vibration</p> <p>Frequency (Hz)</p> <p>Time (sec)</p>
<p>Roll Into Cutting Approach</p> <p>Exit chips have zero thickness.</p>	<p>Cutting load increases smoothly.</p>	<p>Almost no vibration</p> <p>Primary mode</p>

Down cutting (climb milling) is recommended.

Notes on Use of Inserts with Large Corner Radii

When using inserts with corner radius $RE \geq R3.2\text{mm}$, please machine the cutter body with a radius form as shown on the table below.



Insert Corner R (RE)

Cutter Body R

Insert Corner R RE (mm)	Cutter Body Radius R (mm)
3.2	3.0
4.0	4.0
5.0	5.0
6.35	6.2

ROTATING TOOLS

BALL NOSE END MILL



SRF/SRB

- P M K N S H

ROTATING TOOLS

K



Fig.1

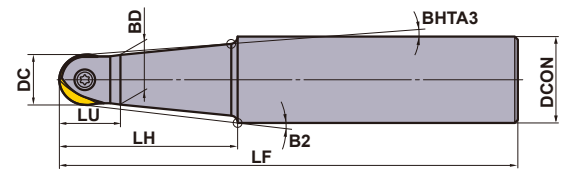

Fig.2

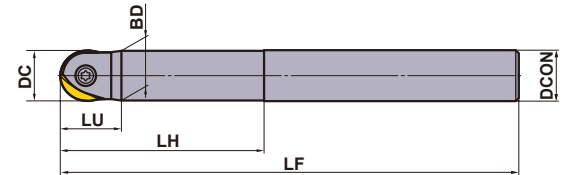
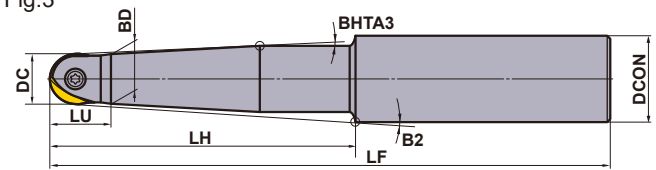

Fig.3



Right hand tool holder only.

STEEL SHANK TYPE

Type	Order Number	Stock	Number of Teeth	Dimensions (mm)								Fig.	*1 Clamp Screw	*2 Wrench	Insert	
				RE*2	DC	DCON	LF	BD	LH	LU	B2					BHTA3
Standard	SRFH10S12M	●	1	5	10	12	110	9.5	40	13	1.63°	1.5°	1	RS3008T	①TKY08D	SRFT10 SRBT10
	SRFH12S16M	●	1	6	12	16	120	11.5	50	15	2.6°	1.5°	1	RS3510T	①TKY10D	SRFT12 SRBT12
	SRFH16S20M	●	1	8	16	20	130	15.5	50	20	2.73°	1.5°	1	RS4015T	②TKY15T	SRFT16 SRBT16
	SRFH20S25M	●	1	10	20	25	150	19.5	70	24	2.38°	1.5°	1	RS5020T	②TKY20T	SRFT20 SRBT20
	SRFH25S32M	●	1	12.5	25	32	180	24.5	80	30	2.97°	1.5°	1	RS6025T	②TKY25T	SRFT25 SRBT25
	SRFH30S32M	●	1	15	30	32	200	29.5	100	35	—	—	2	RS8030T	②TKY30T	SRFT30 SRBT30
	SRFH32S32M	●	1	16	32	32	200	31.5	100	35	—	—	2	RS8030T	②TKY30T	SRFT32 SRBT32
Semi-long	SRFH10S12L	●	1	5	10	12	150	9.5	60	13	1.5°	1.5°	1	RS3008T	①TKY08D	SRFT10 SRBT10
	SRFH12S16L	●	1	6	12	16	160	11.5	70	15	1.78°	1.5°	1	RS3510T	①TKY10D	SRFT12 SRBT12
	SRFH16S20L	●	1	8	16	20	160	15.5	70	20	1.85°	1.5°	1	RS4015T	②TKY15T	SRFT16 SRBT16
	SRFH20S25L	●	1	10	20	25	180	19.5	80	24	2.05°	1.5°	1	RS5020T	②TKY20T	SRFT20 SRBT20
	SRFH20S20L80	●	1	10	20	20	180	19.5	80	24	—	—	2	RS5020T	②TKY20T	SRFT20 SRBT20
	SRFH25S32L	★	1	12.5	25	32	200	24.5	100	30	2.28°	1.5°	1	RS6025T	②TKY25T	SRFT25 SRBT25
	SRFH25S25L100	●	1	12.5	25	25	200	24.5	100	30	—	—	2	RS6025T	②TKY25T	SRFT25 SRBT25
SRFH30S32L	★	1	15	30	32	230	29.5	130	35	—	—	2	RS8030T	②TKY30T	SRFT30 SRBT30	
Long	SRFH20S25E	●	1	10	20	25	220	19.5	120	24	1.5°	1.5°	3	RS5020T	②TKY20T	SRFT20 SRBT20
	SRFH20S20E120	●	1	10	20	20	220	19.5	120	24	—	—	2	RS5020T	②TKY20T	SRFT20 SRBT20
	SRFH25S32E	●	1	12.5	25	32	250	24.5	150	30	1.5°	1.5°	3	RS6025T	②TKY25T	SRFT25 SRBT25
	SRFH25S25E150	●	1	12.5	25	25	250	24.5	150	30	—	—	2	RS6025T	②TKY25T	SRFT25 SRBT25
	SRFH30S32E	●	1	15	30	32	300	29.5	200	35	—	—	2	RS8030T	②TKY30T	SRFT30 SRBT30

*1 Clamp Torque (N · m) : RS3008T=1.5, RS3510T=2.5, RS4015T=3.3, RS5020T=5.0, RS6025T=7.5, RS8030T=10.0

*2 RE is shown for insert corner R.

● : Inventory maintained. ★ : Inventory maintained in Japan.



Fig.1

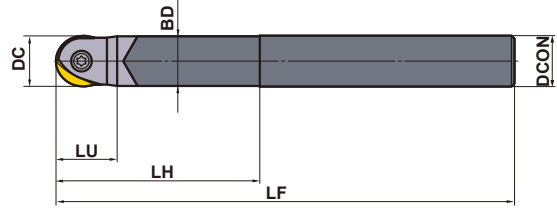

Right hand tool holder only.

■ CARBIDE SHANK TYPE

Type	Order Number	Stock	Number of Teeth	Dimensions (mm)							Fig.	*1	①	②	Insert
				RE*2	DC	DCON	LF	BD	LH	LU					
Standard	SRFH10S10MW	●	1	5	10	10	110	9.5	40	13	1	RS3008T	①TKY08D	SRFT10 SRBT10	
	SRFH12S12MW	●	1	6	12	12	120	11.5	50	15	1	RS3510T	①TKY10D	SRFT12 SRBT12	
	SRFH16S16MW	●	1	8	16	16	130	15.5	50	20	1	RS4015T	②TKY15T	SRFT16 SRBT16	
	SRFH20S20MW	●	1	10	20	20	180	19.5	80	24	1	RS5020T	②TKY20T	SRFT20 SRBT20	
	SRFH25S25MW	●	1	12.5	25	25	200	24.5	100	30	1	RS6025T	②TKY25T	SRFT25 SRBT25	
	SRFH30S32MW	★	1	15	30	32	230	29.5	130	35	1	RS8030T	②TKY30T	SRFT30 SRBT30	
			16	32	32	231	29.5	131	36	SRFT32 SRBT32					
Long	SRFH10S10LW	●	1	5	10	10	150	9.5	60	13	1	RS3008T	①TKY08D	SRFT10 SRBT10	
	SRFH12S12LW	●	1	6	12	12	160	11.5	70	15	1	RS3510T	①TKY10D	SRFT12 SRBT12	
	SRFH16S16LW	●	1	8	16	16	160	15.5	70	20	1	RS4015T	②TKY15T	SRFT16 SRBT16	
	SRFH16S16EW	●	1	8	16	16	200	15.5	110	20	1	RS4015T	②TKY15T	SRFT16 SRBT16	
	SRFH20S20LW	●	1	10	20	20	250	19.5	150	24	1	RS5020T	②TKY20T	SRFT20 SRBT20	
	SRFH25S25LW	★	1	12.5	25	25	300	24.5	200	30	1	RS6025T	②TKY25T	SRFT25 SRBT25	
	SRFH30S32LW	★	1	15	30	32	350	29.5	250	35	1	RS8030T	②TKY30T	SRFT30 SRBT30	
			16	32	32	351	29.5	251	36	SRFT32 SRBT32					

Note 1) SRFH30S32MW and SRFH30S32LW tool body can use both inserts SRFT30 and SRFT32. However, the overall length size LF is different respectively.

*1 Clamp Torque (N · m) : RS3008T=1.5, RS3510T=2.5, RS4015T=3.3, RS5020T=5.0, RS6025T=7.5, RS8030T=10.0

*2 RE is shown for insert corner R.

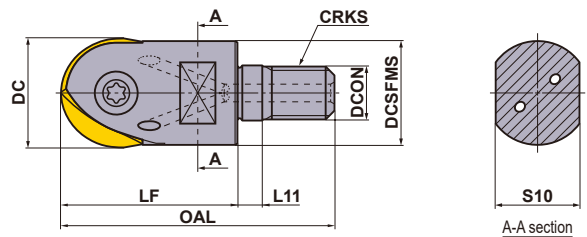

■ SCREW-IN TYPE

Right hand tool holder only.

Order Number	Stock	Coolant Hole	Number of Teeth	Dimensions (mm)									*3 WT (kg)	*1	Wrench	Insert
				RE*2	DC	DCON	DCSFMS	OAL	LF	L11	S10	CRKS				
SRFH16AM0830	●	○	1	8	16	8.5	14.9	48	30	6	10	8	0.1	RS4015T	TKY15T	SRFT16 SRBT16
SRFH20AM1035	●	○	1	10	20	10.5	18.4	54	35	6	14	10	0.1	RS5020T	TKY20T	SRFT20 SRBT20
SRFH25AM1240	●	○	1	12.5	25	12.5	23.5	62	40	6	19	12	0.1	RS6025T	TKY25T	SRFT25 SRBT25
SRFH30AM1645	●	○	1	15	30	17	28.1	68	45	6	24	16	0.2	RS8030T	TKY30T	SRFT30 SRBT30
				16	32	17	28.1	69	46	6	24	16	0.2			SRFT32 SRBT32

Note 1) SRFH30AM1645 tool body can use both inserts SRFT30 and SRFT32. However, the overall length size OAL is different respectively.

Note 2) For screw-in type arbors, refer to page K244.

*1 Clamp Torque (N · m) : RS4015T=3.3, RS5020T=5.0, RS6025T=7.5, RS8030T=10.0



*2 RE is shown for insert corner R.

*3 WT : Tool Weight

ARBORS > K244
SPARE PARTS > N001
TECHNICAL DATA > P001

ROTATING TOOLS

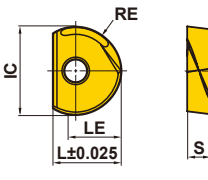
INSERTS

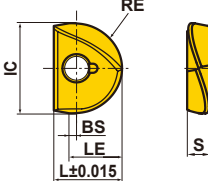
Work Material	P	Steel	●	●	●	Cutting Conditions : ● : Stable Cutting ● : General Cutting ✖ : Unstable Cutting						
	M	Stainless Steel	●	●	●							
K	Cast Iron	●	●	●								
N	Non-ferrous Metal	●	●	●								
H	Hardened Steel	●	●	●								
Shape	Order Number	Coated			Dimensions (mm)						Geometry	
		EP6120	VP15TF	MP8010	IC	RE		L	LE	BS		S
						Corner R	Tolerance					
	SRBT10	●	●	●	10	5	±0.02	8.5	5	—	2.6	
	SRBT12	●	●	●	12	6	±0.02	10	6	—	3	
	SRBT16	●	●	●	16	8	±0.025	12	8	—	4	
	SRBT20	●	●	●	20	10	±0.025	15	10	—	5	
	SRBT25	●	●	●	25	12.5	±0.035	18.5	12.5	—	6	
	SRBT30	●	●	●	30	15	±0.035	22.5	15	—	7	
	SRBT32	●	●	●	32	16	±0.035	23.5	16	—	7	
	SRFT10	●	●	●	10	5	±0.006	8.5	5.5	0.5	2.6	
	SRFT12	●	●	●	12	6	±0.006	10	6.5	0.5	3	
	SRFT16	●	●	●	16	8	±0.006	12	9	1	4	
	SRFT20	●	●	●	20	10	±0.006	15	11	1	5	
	SRFT25	●	●	●	25	12.5	±0.006	18.5	13.5	1	6	
	SRFT30	●	●	●	30	15	±0.006	22.5	16	1	7	
	SRFT32	●	●	●	32	16	±0.006	23.5	17	1	7	

FITTING INSERTS ON HOLDERS

1. Clean the insert seat

Clean the insert seat in the holder body by blowing air or using a brush.

2. Fit the insert

Place the concave mark of the insert into the clamp-screw-fastening part of the holder (only SRF type inserts). Fasten the clamp screw while firmly pressing the insert against the insert seat wall. You are recommended to use the special lubricant to prevent the screw seizing, MK1KS, and to fasten with recommended torque.



RECOMMENDED CUTTING CONDITIONS

	Work Material	Hardness	Grade	Cutting Speed V_c (m/min)	Feed per Tooth f_z (mm/t.)	Depth of Cut a_p (mm)
P	Mild Steel	≤180HB	EP6120	200 (80–300)	0.2 (0.1–0.3)	≤0.05DC
	Carbon Steel, Alloy Steel	180–280HB	EP6120	200 (80–300)	0.2 (0.1–0.3)	≤0.05DC
			VP15TF	200 (80–300)	0.2 (0.1–0.3)	≤0.05DC
	Carbon Steel, Alloy Steel	280–350HB	EP6120	200 (80–300)	0.2 (0.1–0.3)	≤0.05DC
	Pre-Hardened Steel	35–45HRC	EP6120	150 (80–200)	0.2 (0.1–0.3)	≤0.05DC
			VP15TF	150 (80–200)	0.2 (0.1–0.3)	≤0.05DC
Alloy Tool Steel	≤350HB	EP6120	150 (80–200)	0.2 (0.1–0.3)	≤0.05DC	
		VP15TF	150 (80–200)	0.2 (0.1–0.3)	≤0.05DC	
K	Gray Cast Iron	Tensile Strength ≤350MPa	MP8010	250 (80–450)	0.2 (0.1–0.3)	≤0.05DC
	Ductile Cast Iron	Tensile Strength ≤450MPa	MP8010	200 (80–300)	0.2 (0.1–0.3)	≤0.05DC
	Ductile Cast Iron	Tensile Strength ≤800MPa	MP8010	200 (80–300)	0.2 (0.1–0.3)	≤0.05DC
N	Copper, Copper alloys	—	EP6120	200 (80–300)	0.2 (0.1–0.3)	≤0.05DC
H	Hardened Steel	45–55HRC	MP8010	100 (60–120)	0.2 (0.1–0.3)	≤0.05DC
	Hardened Steel	55–65HRC	MP8010	80 (60–120)	0.2 (0.1–0.3)	≤0.01DC

K

ROTATING TOOLS

Note 1) The above values are average condition values at actual cutting speeds. The values change slightly according to the state of a machine to be used and method of workholding. Adjust the values depending on actual machine condition, referring to the above values.

Note 2) For end mills with a carbide shank, it is possible to set about 20% higher cutting conditions.

Note 3) Please note the following when machining hardened steel with MP8010.

- Shorten the overhang length as much as possible.
- Carbide shank type is recommended.
- Please note especially the setting of the depth of cut to prevent fracturing.

CUTTING SPEED FORMULAE

1. Employing θ° → Calculate cutting speed at point P.
(Cutting speed at the cutting depth border for oblique machining)

$$\text{Formula : Cutting Speed} = \frac{\pi \cdot DC \cdot \sin \theta \cdot n}{1000} \text{ (m/min)}$$

$$\theta^\circ = \cos^{-1} \left(\frac{DC - 2a_p}{DC} \right) + 90 - \alpha$$

n : Spindle Speed (min^{-1})

2. Employing a_p → Calculate cutting speed at point Q.
(Cutting speed at the cutting depth border)

$$\text{Formula : Cutting Speed} = \frac{2\pi n \sqrt{a_p (DC - a_p)}}{1000} \text{ (m/min)}$$

n : Spindle Speed (min^{-1})

DC : Cutting Edge Diameter (mm)

a_p : Depth of Cut (mm)

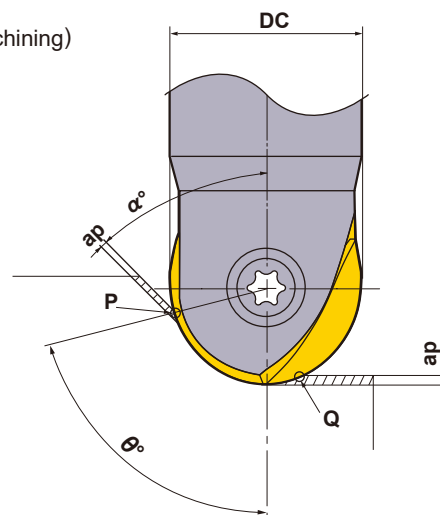

RADIUS END MILL



SUF

- P
- M
- K
- N
- S
- H

ROTATING TOOLS

K



Fig.1

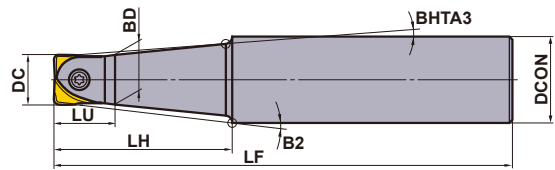

Fig.2

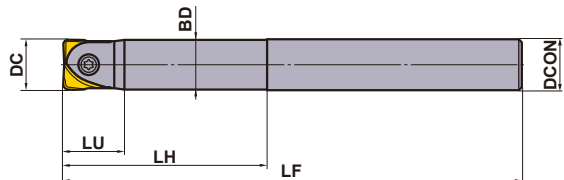
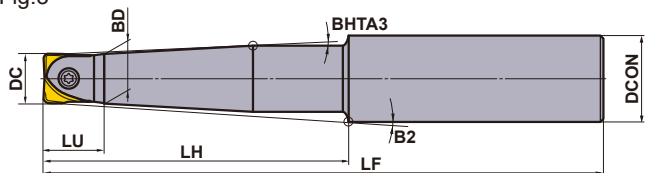

Fig.3



STEEL SHANK TYPE

Right hand tool holder only.

Type	Order Number	Stock	Number of Teeth	Dimensions (mm)								Fig.			
				DC	DCON	LF	BD	LH	LU	B2	BHTA3		Clamp Screw	Wrench	Insert
Standard	SRFH10S12M	●	1	10	12	110	9.5	40	13	1.63°	—	1	RS3008T	①TKY08D	SUFT10R
	SRFH12S16M	●	1	12	16	120	11.5	50	15	2.60°	—	1	RS3510T	①TKY10D	SUFT12R
	SRFH16S20M	●	1	16	20	130	15.5	50	20	2.73°	—	1	RS4015T	②TKY15T	SUFT16R
	SRFH20S25M	●	1	20	25	150	19.5	70	24	2.38°	1.5°	1	RS5020T	②TKY20T	SUFT20R
	SRFH25S32M	●	1	25	32	180	24.5	80	30	2.97°	1.5°	1	RS6025T	②TKY25T	SUFT25R
	SRFH30S32M	●	1	30	32	200	29.5	100	35	—	—	2	RS8030T	②TKY30T	SUFT30R
	SRFH32S32M	●	1	32	32	200	31.5	100	35	—	—	2	RS8030T	②TKY30T	SUFT32R
Semi-long	SRFH10S12L	●	1	10	12	150	9.5	60	13	1.5°	—	1	RS3008T	①TKY08D	SUFT10R
	SRFH12S16L	●	1	12	16	160	11.5	70	15	1.78°	—	1	RS3510T	①TKY10D	SUFT12R
	SRFH16S20L	●	1	16	20	160	15.5	70	20	1.85°	—	1	RS4015T	②TKY15T	SUFT16R
	SRFH20S25L	●	1	20	25	180	19.5	80	24	2.05°	1.5°	1	RS5020T	②TKY20T	SUFT20R
	SRFH20S20L80	●	1	20	20	180	19.5	80	24	—	—	2	RS5020T	②TKY20T	SUFT20R
	SRFH25S32L	★	1	25	32	200	24.5	100	30	2.28°	1.5°	1	RS6025T	②TKY25T	SUFT25R
	SRFH25S25L100	●	1	25	25	200	24.5	100	30	—	—	2	RS6025T	②TKY25T	SUFT25R
SRFH30S32L	★	1	30	32	230	29.5	130	35	—	—	2	RS8030T	②TKY30T	SUFT30R	
Long	SRFH20S25E	●	1	20	25	220	19.5	120	24	1.5°	1.5°	3	RS5020T	②TKY20T	SUFT20R
	SRFH20S20E120	●	1	20	20	220	19.5	120	24	—	—	2	RS5020T	②TKY20T	SUFT20R
	SRFH25S32E	●	1	25	32	250	24.5	150	30	1.5°	1.5°	3	RS6025T	②TKY25T	SUFT25R
	SRFH25S25E150	●	1	25	25	250	24.5	150	30	—	—	2	RS6025T	②TKY25T	SUFT25R
	SRFH30S32E	●	1	30	32	300	29.5	200	35	—	—	2	RS8030T	②TKY30T	SUFT30R

* Clamp Torque (N · m) : RS3008T=1.5, RS3510T=2.5, RS4015T=3.3, RS5020T=5.0, RS6025T=7.5, RS8030T=10.0

● : Inventory maintained. ★ : Inventory maintained in Japan.



Fig.1

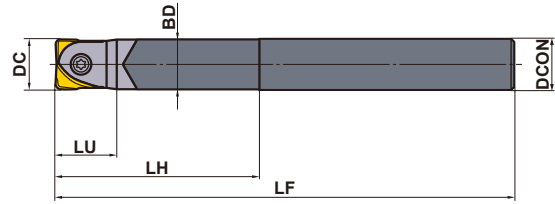

■ CARBIDE SHANK TYPE

Right hand tool holder only.

Type	Order Number	Stock	Number of Teeth	Dimensions (mm)						Fig.	* 		
				DC	DCON	LF	BD	LH	LU				
Standard	SRFH10S10MW	●	1	10	10	110	9.5	40	13	1	RS3008T	①TKY08D	SUFT10R
	SRFH12S12MW	●	1	12	12	120	11.5	50	15	1	RS3510T	①TKY10D	SUFT12R
	SRFH16S16MW	●	1	16	16	130	15.5	50	20	1	RS4015T	②TKY15T	SUFT16R
	SRFH20S20MW	●	1	20	20	180	19.5	80	24	1	RS5020T	②TKY20T	SUFT20R
	SRFH25S25MW	●	1	25	25	200	24.5	100	30	1	RS6025T	②TKY25T	SUFT25R
	SRFH30S32MW	★	1	30	32	230	29.5	130	35	1	RS8030T	②TKY30T	SUFT30R
			32	32	231	29.5	131	36	SUFT32R				
Long	SRFH10S10LW	●	1	10	10	150	9.5	60	13	1	RS3008T	①TKY08D	SUFT10R
	SRFH12S12LW	●	1	12	12	160	11.5	70	15	1	RS3510T	①TKY10D	SUFT12R
	SRFH16S16LW	●	1	16	16	160	15.5	70	20	1	RS4015T	②TKY15T	SUFT16R
	SRFH20S20LW	●	1	20	20	250	19.5	150	24	1	RS5020T	②TKY20T	SUFT20R
	SRFH25S25LW	★	1	25	25	300	24.5	200	30	1	RS6025T	②TKY25T	SUFT25R
	SRFH30S32LW	★	1	30	32	350	29.5	250	35	1	RS8030T	②TKY30T	SUFT30R
			32	32	351	29.5	251	36	SUFT32R				

Note 1) SRFH30S32MW and SRFH30S32LW tool body can use both inserts SUFT30R and SUFT32R.
However, the overall length size LF is different respectively.

* Clamp Torque (N · m) : RS3008T=1.5, RS3510T=2.5, RS4015T=3.3, RS5020T=5.0, RS6025T=7.5, RS8030T=10.0

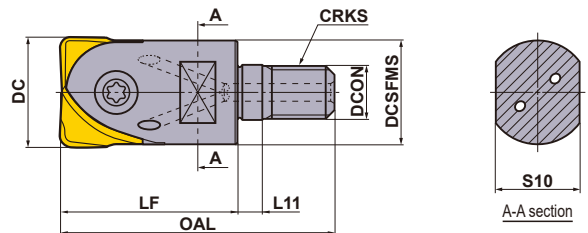

■ SCREW-IN TYPE

Right hand tool holder only.

Order Number	Stock	Coolant Hole	Number of Teeth	Dimensions (mm)								*2 WT (kg)	*1 		
				DC	DCON	DCSFMS	OAL	LF	L11	S10	CRKS				
SRFH16AM0830	●	○	1	16	8.5	14.9	48	30	6	10	8	0.1	RS4015T	TKY15T	SUFT16R
SRFH20AM1035	●	○	1	20	10.5	18.4	54	35	6	14	10	0.1	RS5020T	TKY20T	SUFT20R
SRFH25AM1240	●	○	1	25	12.5	23.5	62	40	6	19	12	0.1	RS6025T	TKY25T	SUFT25R
SRFH30AM1645	●	○	1	30	17	28.1	68	45	6	24	16	0.2	RS8030T	TKY30T	SUFT30R
				32	17	28.1	69	46	6	24	16				SUFT32R

Note 1) SRFH30AM1645 tool body can use both inserts SUFT30R and SUFT32R.
However, the overall length size OAL is different respectively.

Note 2) For screw-in type arbors, refer to page K244.

*1 Clamp Torque (N · m) : RS4015T=3.3, RS5020T=5.0, RS6025T=7.5, RS8030T=10.0

*2 WT : Tool Weight

ARBORS > K244
SPARE PARTS > N001
TECHNICAL DATA > P001

ROTATING TOOLS

INSERTS

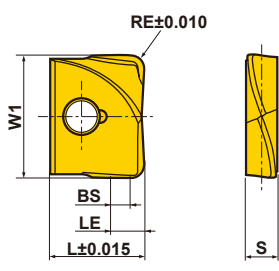
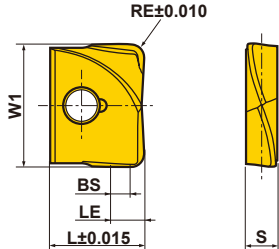
Work Material	P	Steel	Coated	MP8010	VP15TF	Cutting Conditions :					Geometry
	M	Stainless Steel				●	Stable Cutting	●	General Cutting	✱	
Shape	K	Cast Iron	Dimensions (mm)		W1	RE	BS	LE	L	S	Geometry
	H	Hardened Steel									
<div style="writing-mode: vertical-rl; transform: rotate(180deg);">ROTATING TOOLS</div> 	SUFT10R05	● ●		10	0.5	1	1.5	8.5	2.6		
	SUFT10R10	● ●		10	1	1	2	8.5	2.6		
	SUFT10R20	● ★		10	2	1	3	8.5	2.6		
	SUFT12R05	● ●		12	0.5	1.2	1.7	10	3		
	SUFT12R10	● ●		12	1	1.2	2.2	10	3		
	SUFT12R20	● ●		12	2	1.2	3.2	10	3		
	SUFT12R30	★ ●		12	3	1.2	4.2	10	3		
	SUFT16R05	● ●		16	0.5	1.6	2.1	12	4		
	SUFT16R10	● ●		16	1	1.6	2.6	12	4		
	SUFT16R15	★ ●		16	1.5	1.6	3.1	12	4		
	SUFT16R20	● ●		16	2	1.6	3.6	12	4		
	SUFT16R30	★ ●		16	3	1.6	4.6	12	4		
	SUFT20R05	● ●		20	0.5	2	2.5	15	5		
	SUFT20R10	● ●		20	1	2	3	15	5		
	SUFT20R15	★ ●		20	1.5	2	3.5	15	5		
	SUFT20R20	● ●		20	2	2	4	15	5		
	SUFT20R30	● ●		20	3	2	5	15	5		
	SUFT25R05	★ ●		25	0.5	2.5	3	18.5	6		
	SUFT25R10	● ★		25	1	2.5	3.5	18.5	6		
	SUFT25R20	★ ●		25	2	2.5	4.5	18.5	6		
	SUFT25R30	★ ●		25	3	2.5	5.5	18.5	6		
	SUFT30R05	★ ★		30	0.5	3	3.5	22.5	7		
	SUFT30R10	★ ★		30	1	3	4	22.5	7		
	SUFT30R20	★ ★		30	2	3	5	22.5	7		
	SUFT30R30	★ ★		30	3	3	6	22.5	7		
	SUFT32R05	★ ★		32	0.5	3.2	3.7	23.5	7		
	SUFT32R10	★ ★		32	1	3.2	4.2	23.5	7		
	SUFT32R20	★ ★		32	2	3.2	5.2	23.5	7		

FITTING INSERTS ON HOLDERS

1. Clean the insert seat

Clean the insert seat in the holder body by blowing air or using a brush.

2. Fit the insert

Place the concave mark of the insert into the clamp-screw-fastening part of the holder (only SRF type inserts). Fasten the clamp screw while firmly pressing the insert against the insert seat wall. It is recommended to use the special lubricant MK1KS to preventing the screw seizing and to tighten to the recommended torque.



● : Inventory maintained. ★ : Inventory maintained in Japan.
(2 inserts in one case)

RECOMMENDED CUTTING CONDITIONS

■ SHOULDER MILLING (When small width of cut.*)

	Work Material	Hardness	Grade	Cutting Speed V _c (m/min)	Depth of Cut a _p (mm)	Cutting Width a _e (mm)	Feed per Tooth f _z (mm/t.)
P	Carbon Steel Alloy Steel	180–280HB	VP15TF	200 (80–300)	≤0.05DC	≤0.05DC	0.2 (≤0.4)
	Pre-Hardened Steel	≤45HRC	VP15TF	150 (80–200)	≤0.05DC	≤0.05DC	0.15 (≤0.3)
	Alloy Tool Steel	180–380HB	VP15TF	150 (80–200)	≤0.05DC	≤0.05DC	0.15 (≤0.3)
M	Stainless Steel	≤270HB	VP15TF	150 (100–200)	≤0.05DC	≤0.05DC	0.2 (≤0.4)
K	Gray Cast Iron	Tensile Strength ≤350MPa	MP8010	250 (180–450)	≤0.05DC	≤0.1DC	0.3 (≤0.4)
	Ductile Cast Iron	Tensile Strength ≤800MPa	MP8010	200 (80–300)	≤0.05DC	≤0.1DC	0.3 (≤0.4)
H	Hardened Steel	45–55HRC	MP8010	100 (80–120)	≤0.05DC	≤0.02DC	0.1 (≤0.2)
	Hardened Steel	55–65HRC	MP8010	80 (60–100)	≤0.05DC	≤0.02DC	0.1 (≤0.2)

* When the pick feed direction is along the axis of the tool such as finish machining at the wall part.

■ SLOTTING-SHOULDER MILLING (When large width of cut.*)

	Work Material	Hardness	Grade	Cutting Speed V _c (m/min)	Depth of Cut a _p (mm)	Cutting Width a _e (mm)	Feed per Tooth f _z (mm/t.)
P	Carbon Steel Alloy Steel	180–280HB	VP15TF	200 (80–300)	≤0.02DC	≤DC	0.2 (≤0.4)
	Pre-Hardened Steel	≤45HRC	VP15TF	150 (80–200)	≤0.02DC	≤DC	0.15 (≤0.3)
	Alloy Tool Steel	180–380HB	VP15TF	150 (80–200)	≤0.02DC	≤DC	0.15 (≤0.3)
M	Stainless Steel	≤270HB	VP15TF	150 (100–200)	≤0.02DC	≤DC	0.2 (≤0.4)
K	Gray Cast Iron	Tensile Strength ≤350MPa	MP8010	250 (180–450)	≤0.03DC	≤DC	0.3 (≤0.4)
	Ductile Cast Iron	Tensile Strength ≤800MPa	MP8010	200 (80–300)	≤0.03DC	≤DC	0.3 (≤0.4)
H	Hardened Steel	45–55HRC	MP8010	100 (80–120)	≤0.01DC	≤DC	0.1 (≤0.2)
	Hardened Steel	55–65HRC	MP8010	70 (60–80)	≤0.01DC	≤DC	0.1 (≤0.2)

* When the pick feed direction is along the axis of the tool such as finish machining at the wall part.

Note 1) This cutting condition is the standard condition when using the steel standard shank type. If vibration or chipping of the insert occurs on the cutting edge, please decrease the cutting condition as width of cut, depth of cut and feed per tooth depending on the situation.

Note 2) Cutting speed is calculated at the peripheral edge of the tool. Calculate spindle speed in the following way.

$$\text{Spindle speed of cutting tool } n(\text{min}^{-1}) = 1000 \times \text{Cutting speed } V_c \div \text{Diameter of cutting tool } DC \div 3.14$$

Note 3) Please note the following when machining hardened steel with MP8010.

- Shorten the overhang length as much as possible.
- Use with carbide shank recommended.
- Note the setting of the depth of cut especially to prevent the fracture.

ROTATING TOOLS

BALL NOSE END MILL



SRM2

- P
- M
- K
- N
- S
- H

ROTATING TOOLS



● Standard Type

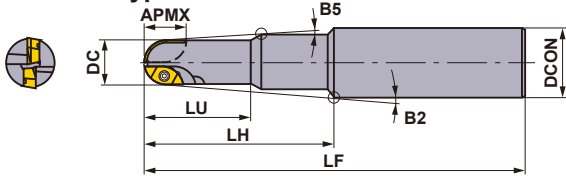

● Long Neck Type

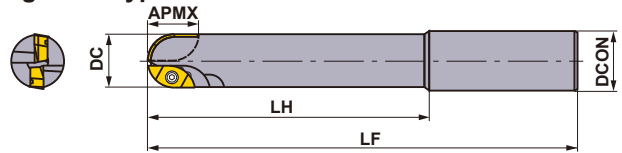

● Long Cutting Edge Type

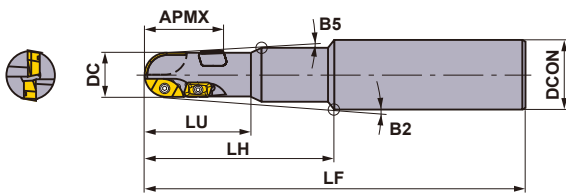

● Long Neck Cutting Edge Type

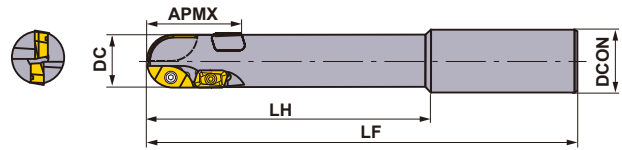

● Extra Long Cutting Edge Type

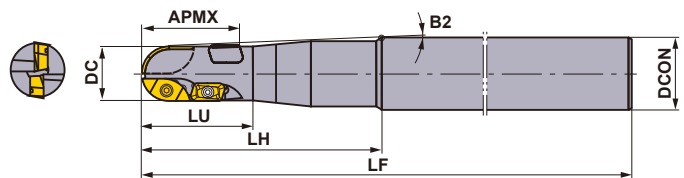

Right hand tool holder only.

Type	Order Number	Stock R	Coolant Hole ○	Number of Teeth	Dimensions (mm)								*1		① ② ③		Insert		Peripheral	
					RE *2	DC	DCON	LF	LH	LU	APMX	B2	B5	Inner	Outer	Inner	Outer	Inner		Outer
Standard	SRM2160SNM	★	—	2	8	16	20	130	50	25	12	2.8°	1.5°	TS25H	—	①TKY08D	—	SRG16C	SRG16E	—
	SRM2160SAM	●	○	2	8	16	20	130	50	25	12	2.8°	1.5°	TS25H	—	①TKY08D	—	SRM16C-M	SRM16E-M	—
	SRM2200SNM	★	—	2	10	20	25	150	70	35	14	2.45°	1.5°	TS32	—	①TKY08D	—	SRG20C	SRG20E	—
	SRM2200SAM	●	○	2	10	20	25	150	70	35	14	2.45°	1.5°	TS32	—	①TKY08D	—	SRM20C-M	SRM20E-M	—
	SRM2250SNM	★	—	2	12.5	25	32	180	80	40	19	3.22°	1.5°	TS43	—	②TKY15T	—	SRG25C	SRG25E	—
	SRM2250SAM	●	○	2	12.5	25	32	180	80	40	19	3.22°	1.5°	TS43	—	②TKY15T	—	SRM25C-M	SRM25E-M	—
	SRM2300SNM	★	—	2	15	30	32	200	100	50	24	0.73°	0.5°	TS55	—	②TKY25T	—	SRG30C	SRG30E	—
	SRM2300SAM	●	○	2	15	30	32	200	100	50	24	0.73°	0.5°	TS55	—	②TKY25T	—	SRM30C-M	SRM30E-M	—
	SRM2320SAM	●	—	2	16	32	32	200	100	45	28	0.5°	0.5°	TS55	—	②TKY25T	—	SRG32C	SRG32E	—

*1 Clamp Torque (N · m) : TS25H=1.7, TS25=1.0, TS32=2.0, TS43=3.5, TS55=7.5

*2 RE is shown for insert corner R.

● : Inventory maintained. ★ : Inventory maintained in Japan.

Type	Order Number	Stock R	Coolant Hole Number of Teeth	Dimensions (mm)								*1		① ② ③			Inner		Outer		Peripheral	
				RE *2	DC	DCON	LF	LH	LU	APMX	B2	B5	Inner	Outer	Inner	Outer	Inner	Outer	Inner	Outer	Inner	Outer
													Clamp	Screw	Wrench		Insert		Peripheral			
Long Cutting Edge	SRM2200SNL	★	—	4	10	20	25	150	70	35	30	2.45°	1.5°	TS32	TS25	①TKY08D	①TKY08D	SRG20C SRM20C-M	SRG20E SRM20E-M	APMT1135 PDER-②		
	SRM2200SAL	●	○	4	10	20	25	150	70	35	30	2.45°	1.5°	TS32	TS25	①TKY08D	①TKY08D	SRG20C SRM20C-M	SRG20E SRM20E-M	APMT1135 PDER-②		
	SRM2250SNL	★	—	4	12.5	25	32	180	80	40	37	3.22°	1.5°	TS43	TS25	②TKY15T	③TKY08F	SRG25C SRM25C-M	SRG25E SRM25E-M	APMT1135 PDER-②		
	SRM2250SAL	●	○	4	12.5	25	32	180	80	40	37	3.22°	1.5°	TS43	TS25	②TKY15T	③TKY08F	SRG25C SRM25C-M	SRG25E SRM25E-M	APMT1135 PDER-②		
	SRM2300SNL	★	—	4	15	30	32	200	100	50	44	0.73°	0.5°	TS55	TS43	②TKY25T	③TKY15F	SRG30C SRM30C-M	SRG30E SRM30E-M	APMT1604 PDER-②		
	SRM2300SAL	★	○	4	15	30	32	200	100	50	44	0.73°	0.5°	TS55	TS43	②TKY25T	③TKY15F	SRG30C SRM30C-M	SRG30E SRM30E-M	APMT1604 PDER-②		
	SRM2320SAL	●	—	4	16	32	32	200	100	60	44	0.5°	0.5°	TS55	TS43	②TKY25T	③TKY15F	SRG32C SRM32C-M	SRG32E SRM32E-M	APMT1604 PDER-②		
Long Neck	SRM2160SNF	★	—	2	8	16	16	150	70	—	12	—	—	TS25H	—	①TKY08D	—	SRG16C SRM16C-M	SRG16E SRM16E-M	—		
	SRM2160SAF	★	○	2	8	16	16	150	70	—	12	—	—	TS25H	—	①TKY08D	—	SRG16C SRM16C-M	SRG16E SRM16E-M	—		
	SRM2200SNF	★	—	2	10	20	20	180	100	—	14	—	—	TS32	—	①TKY08D	—	SRG20C SRM20C-M	SRG20E SRM20E-M	—		
	SRM2200SAF	★	○	2	10	20	20	180	100	—	14	—	—	TS32	—	①TKY08D	—	SRG20C SRM20C-M	SRG20E SRM20E-M	—		
	SRM2250SNF	★	—	2	12.5	25	25	200	120	—	19	—	—	TS43	—	②TKY15T	—	SRG25C SRM25C-M	SRG25E SRM25E-M	—		
	SRM2250SAF	★	○	2	12.5	25	25	200	120	—	19	—	—	TS43	—	②TKY15T	—	SRG25C SRM25C-M	SRG25E SRM25E-M	—		
	SRM2300SNF	★	—	2	15	30	32	230	150	—	24	—	—	TS55	—	②TKY25T	—	SRG30C SRM30C-M	SRG30E SRM30E-M	—		
	SRM2300SAF	★	○	2	15	30	32	230	150	—	24	—	—	TS55	—	②TKY25T	—	SRG30C SRM30C-M	SRG30E SRM30E-M	—		
Long Neck Cutting Edge	SRM2200SNLF	★	—	4	10	20	20	180	100	—	30	—	—	TS32	TS25	①TKY08D	①TKY08D	SRG20C SRM20C-M	SRG20E SRM20E-M	APMT1135 PDER-②		
	SRM2200SALF	★	○	4	10	20	20	180	100	—	30	—	—	TS32	TS25	①TKY08D	①TKY08D	SRG20C SRM20C-M	SRG20E SRM20E-M	APMT1135 PDER-②		
	SRM2250SNLF	★	—	4	12.5	25	25	200	120	—	37	—	—	TS43	TS25	②TKY15T	③TKY08F	SRG25C SRM25C-M	SRG25E SRM25E-M	APMT1135 PDER-②		
	SRM2250SALF	★	○	4	12.5	25	25	200	120	—	37	—	—	TS43	TS25	②TKY15T	③TKY08F	SRG25C SRM25C-M	SRG25E SRM25E-M	APMT1135 PDER-②		
	SRM2300SNLF	★	—	4	15	30	32	230	150	—	44	—	—	TS55	TS43	②TKY25T	③TKY15F	SRG30C SRM30C-M	SRG30E SRM30E-M	APMT1604 PDER-②		
	SRM2300SALF	★	○	4	15	30	32	230	150	—	44	—	—	TS55	TS43	②TKY25T	③TKY15F	SRG30C SRM30C-M	SRG30E SRM30E-M	APMT1604 PDER-②		
Extra Long Cutting Edge	SRM2200SNLL	★	—	4	10	20	25	250	120	35	30	1.5°	—	TS32	TS25	①TKY08D	①TKY08D	SRG20C SRM20C-M	SRG20E SRM20E-M	APMT1135 PDER-②		
	SRM2200SALL	★	○	4	10	20	25	250	120	35	30	1.5°	—	TS32	TS25	①TKY08D	①TKY08D	SRG20C SRM20C-M	SRG20E SRM20E-M	APMT1135 PDER-②		
	SRM2250SNLL	★	—	4	12.5	25	32	300	170	37	37	1.5°	—	TS43	TS25	②TKY15T	③TKY08F	SRG25C SRM25C-M	SRG25E SRM25E-M	APMT1135 PDER-②		
	SRM2250SALL	★	○	4	12.5	25	32	300	170	37	37	1.5°	—	TS43	TS25	②TKY15T	③TKY08F	SRG25C SRM25C-M	SRG25E SRM25E-M	APMT1135 PDER-②		
	SRM2300SNLL	★	—	4	15	30	32	350	100	50	44	1.5°	—	TS55	TS43	③TKY25T	③TKY15F	SRG30C SRM30C-M	SRG30E SRM30E-M	APMT1604 PDER-②		
	SRM2300SALL	★	○	4	15	30	32	350	100	50	44	1.5°	—	TS55	TS43	③TKY25T	③TKY15F	SRG30C SRM30C-M	SRG30E SRM30E-M	APMT1604 PDER-②		

*1 Clamp Torque (N · m) : TS25H=1.7, TS25=1.0, TS32=2.0, TS43=3.5, TS55=7.5

*2 RE is shown for insert corner R.

SPARE PARTS > N001
TECHNICAL DATA > P001

ROTATING TOOLS

ROTATING TOOLS



● Standard Type

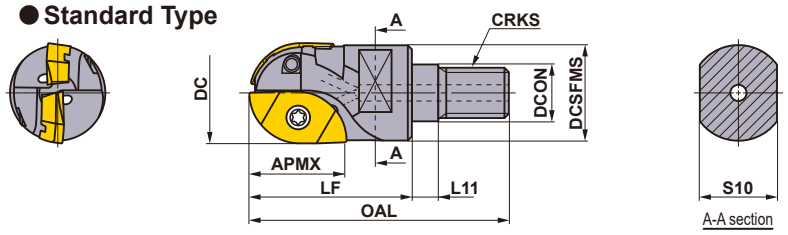

● Long Cutting Edge Type

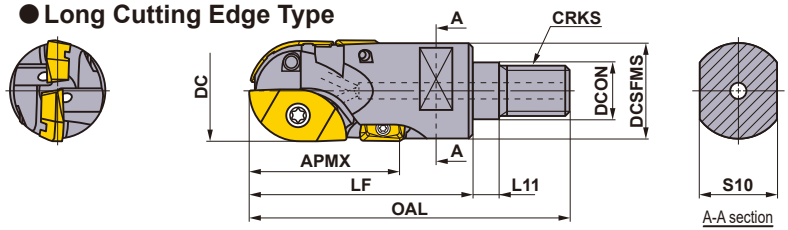

■ SCREW-IN TYPE

Right hand tool holder only.

Type	Order Number	Stock R	Coolant Hole ○	Dimensions (mm)									*3 WT (kg)	*1		① ② ③	Insert	Insert	Insert	
				RE *2	DC	DCON	DCSFMS	OAL	LF	L11	S10	CRKS		APMX	Inner, Outer					Peripheral
Standard	SRM2160AM08S30	●	○	8	16	8.5	14.6	48	30	6	10	M8	12	0.1	TS25H	—	①TKY08D	SRG16C SRM16C-M	SRG16E SRM16E-M	—
	SRM2200AM10S35	●	○	10	20	10.5	18.6	54	35	6	14	M10	14	0.1	TS32	—	①TKY08D	SRG20C SRM20C-M	SRG20E SRM20E-M	—
	SRM2250AM12S40	●	○	12.5	25	12.5	23.5	62	40	6	19	M12	19	0.2	TS43	—	②TKY15T	SRG25C SRM25C-M	SRG25E SRM25E-M	—
	SRM2300AM16S45	★	○	15	30	17	28.3	68	45	6	24	M16	24	0.2	TS55	—	②TKY25T	SRG30C SRM30C-M	SRG30E SRM30E-M	—
	SRM2320AM16S45	●	○	16	32	17	30.0	68	45	6	24	M16	28	0.2	TS55	—	②TKY25T	SRG32C SRM32C-M	SRG32E SRM32E-M	—
Long Cutting Edge	SRM2200AM10L45	★	○	10	20	10.5	18.6	64	45	6	14	M10	30	0.2	TS32	TS25	①TKY08D	SRG20C SRM20C-M	SRG20E SRM20E-M	APMT1135 PDER-2
	SRM2200M10L	□	—	10	20	10.5	18.6	66	47	6	15	M10	30	0.2	TS32	TS25	①TKY08D	SRG20C SRM20C-M	SRG20E SRM20E-M	APMT1135 PDER-2
	SRM2250AM12L55	★	○	12.5	25	12.5	23.5	77	55	6	19	M12	37	0.3	TS43	TS25	②TKY15T ③TKY08F	SRG25C SRM25C-M	SRG25E SRM25E-M	APMT1135 PDER-2
	SRM2250M12L	□	—	12.5	25	12.5	23.5	77	55	6	17	M12	37	0.3	TS43	TS25	②TKY15T ③TKY08F	SRG25C SRM25C-M	SRG25E SRM25E-M	APMT1135 PDER-2
	SRM2300AM16L60	★	○	15	30	17	28.3	83	60	6	24	M16	44	0.3	TS55	TS43	②TKY25T ③TKY15F	SRG30C SRM30C-M	SRG30E SRM30E-M	APMT1604 PDER-2
	SRM2300M16L	□	—	15	30	17	28.3	86	63	6	22	M16	44	0.3	TS55	TS43	②TKY15T ③TKY08F	SRG30C SRM30C-M	SRG30E SRM30E-M	APMT1604 PDER-2
	SRM2320AM16L60	★	○	16	32	17	29.0	83	60	6	24	M16	44	0.3	TS55	TS43	②TKY25T ③TKY15F	SRG32C SRM32C-M	SRG32E SRM32E-M	APMT1604 PDER-2
SRM2320M16L	□	—	16	32	17	29.0	86	63	6	22	M16	44	0.3	TS55	TS43	②TKY15T ③TKY08F	SRG32C SRM32C-M	SRG32E SRM32E-M	APMT1604 PDER-2	

Note 1) For screw-in type arbors, refer to page K244.

*1 Clamp Torque (N · m) : TS25H=1.7, TS25=1.0, TS32=2.0, TS43=3.5, TS55=7.5









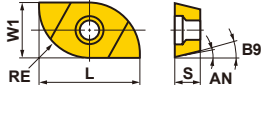

*2 RE is shown for insert corner R.

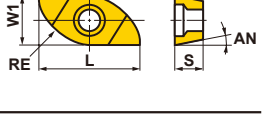
*3 WT : Tool Weight

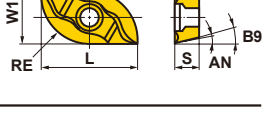
● : Inventory maintained. ★ : Inventory maintained in Japan.

□ : Non stock, produced to order only. (10 inserts in one case)

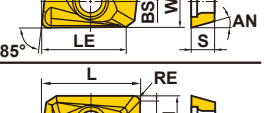
INSERTS

Work Material	P	Steel	●	●	●	Cutting Conditions : ● : Stable Cutting ● : General Cutting ✖ : Unstable Cutting							Geometry		
	M	Stainless Steel	●	●	●		K	Cast Iron	●	✖	S	Heat-resistant Alloy, Titanium Alloy		●	●
Type	Shape	Order Number	Class	Coated				Dimensions (mm)							
				F7030	MP6120	MP9120	VP15TF	RE	L	LE	W1	S	BS		AN
Inner		SRG16C	G	●	★	●	8	16	—	8.2	3.5	—	11°	—	
		SRG20C	G	●	★	●	10	19	—	10.2	4.6	—	10°	18°	
		SRG25C	G	●	★	●	12.5	24	—	12.8	5.5	—	10°	18°	
		SRG30C	G	●	★	●	15	28	—	15.3	7	—	10°	18°	
		SRG32C	G	●	★	●	16	28	—	16.3	7	—	10°	18°	
Outer		SRG16E	G	●	★	●	8	13.5	—	6.7	3.5	—	11°	—	
		SRG20E	G	●	★	●	10	15.5	—	8.5	4.6	—	9°	—	
		SRG25E	G	●	★	●	12.5	20.5	—	10.2	5.5	—	9°	—	
		SRG30E	G	●	★	●	15	25.2	—	12.2	7	—	9°	—	
		SRG32E	G	●	★	●	16	26.1	—	13.1	7	—	9°	—	
Inner		SRM16C-M	M	●	★	●	8	16	—	8.2	3.5	—	11°	—	
		SRM20C-M	M	●	★	●	10	19	—	10.2	4.6	—	10°	18°	
		SRM25C-M	M	●	★	●	12.5	24	—	12.8	5.5	—	10°	18°	
		SRM30C-M	M	●	★	●	15	28	—	15.3	7	—	10°	18°	
		SRM32C-M	M	●	★	●	16	28	—	16.3	7	—	10°	18°	
Outer		SRM16E-M	M	●	★	●	8	13.5	—	6.7	3.5	—	11°	—	
		SRM20E-M	M	●	★	●	10	15.5	—	8.5	4.6	—	9°	—	
		SRM25E-M	M	●	★	●	12.5	20.5	—	10.2	5.5	—	9°	—	
		SRM30E-M	M	●	★	●	15	25.2	—	12.2	7	—	9°	—	
		SRM32E-M	M	●	★	●	16	26.1	—	13.1	7	—	9°	—	
Peripheral		APMT1135PDER-H2	M	●		●	0.8	11.25	9	6.35	3.5	1.2	11°	—	
		APMT1604PDER-H2	M	●		●	0.8	17.11	14	9.525	4.76	1.4	11°	—	
*1		APMT1135PDER-M2	M	●		●	0.8	11.18	9	6.35	3.5	1.2	11°	—	
		APMT1604PDER-M2	M	●		●	0.8	17.10	14	9.525	4.76	1.4	11°	—	

(Low-resistance inner or outer inserts are precision M class type.)

*1 Selection guide for peripheral cutting edges : The first recommendation is the super sharp M breaker (APMT....PDER-M2).

When cutting edge strength is particularly important, use the H breaker (APMT....PDER-H2).

K

ROTATING TOOLS

RECOMMENDED CUTTING CONDITIONS

SRM2 $\varnothing 16 - \varnothing 32$

ROTATING TOOLS

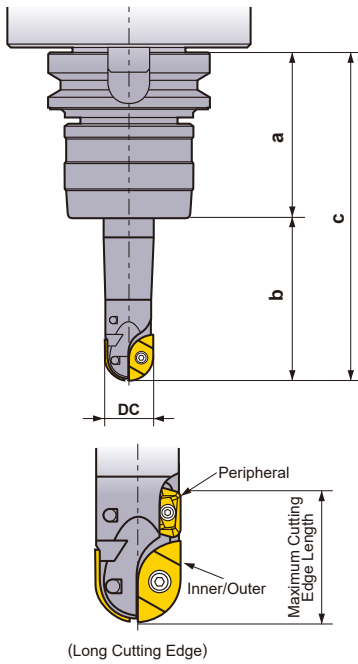

Tool Overhang

The recommended cutting conditions are chosen based on deflection, vibration and surface finish when using a BT50 arbor under the conditions below -"a", a length from the gauge line to the arbor end face and "b", neck length (tool overhang from the arbor).

Cutting Edge Diameter:DC	Type	a	b	c
16	Standard	105	50	155
	Long Neck		70	175
	Extra Long		—	—
20	Standard		70	175
	Long Neck		100	205
	Extra Long		150	255
25	Standard	80	185	
	Long Neck	120	225	
	Extra Long	200	305	
30	Standard	100	205	
	Long Neck	150	255	
	Extra Long	250	355	

Recommended Depth of Cut for Long Cutting Edge Type

The maximum cutting edge length of the long cutting edge type with a peripheral insert is 1.4-1.5DC. The peripheral insert's main purpose is to remove the small un-machined portions of the pre-machined surface above the main cutting edge. Please refer to recommended cutting conditions for recommended depth of cut **ap**.

Radius tolerance and other dimensions with an insert mounted in the body

Radial tolerance

Cutting Edge Diameter DC	Nominal R	Tolerance	R min.	R max.
16	8	G	7.925	7.975
		M	7.910	7.970
20	10	G	9.925	9.975
		M	9.910	9.970
25	12.5	G	12.425	12.475
		M	12.410	12.470
30	15	G	14.925	14.975
		M	14.910	14.970

Dimensions with an insert mounted in the body

Cutting Edge Diameter DC	Tolerance	DC min.	DC max.
16	G	15.800	16.000
	M	15.770	15.990
20	G	19.800	20.000
	M	19.770	19.990
25	G	24.800	25.000
	M	24.770	24.990
30	G	29.800	30.000
	M	29.770	29.990

*M : Precision M class

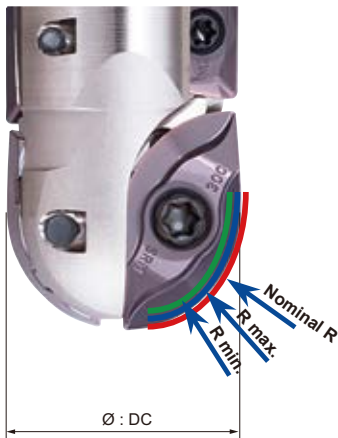

■ SLOT MILLING

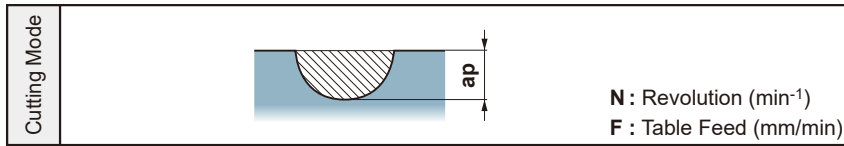

Work Material	Hardness	Cutting Speed (m/min)	Insert Grade, Type	Holder Type	φ16			φ20			φ25			φ30			
					N	F	ap	N	F	ap	N	F	ap	N	F	ap	
P Carbon Steel Alloy Steel	180–280HB	160 (120–200)	MP6120 VP15TF Low Resistance Type	Standard	3183	382	6	2546	306	8	2037	489	12.5	1698	407	15	
				Long Neck	3183	382	4	2546	306	4	2037	489	6	1698	407	7.5	
				Extra Long	—	—	—	2546	306	2	2037	489	4	1698	407	3	
	280–350HB	140 (120–160)	MP6120 VP15TF Low Resistance Type	Standard	2785	334	6	2228	267	8	1783	428	12.5	1485	357	15	
				Long Neck	2785	334	4	2228	267	4	1783	428	6	1485	357	7.5	
				Extra Long	—	—	—	2228	267	2	1783	428	4	1485	357	3	
	Pre-Hardened Steel	35–45HRC	120 (100–160)	MP6120 VP15TF Low Resistance Type	Standard	2387	286	6	1910	229	8	1528	367	12.5	1273	306	15
					Long Neck	2387	286	4	1910	229	4	1528	367	6	1273	306	7.5
					Extra Long	—	—	—	1910	229	2	1528	367	4	1273	306	3
	Alloy Tool Steel	≤350HB	140 (120–160)	MP6120 VP15TF Low Resistance Type	Standard	2785	334	6	2228	267	8	1783	535	10	1485	594	12
					Long Neck	2785	334	4	2228	267	4	1783	535	5	1485	594	4.5
					Extra Long	—	—	—	2228	267	2	1783	535	2.5	1485	594	1.5
M Stainless Steel	≤270HB	200 (100–250)	VP15TF Low Resistance Type	Standard	3979	477	4	3183	382	5	2546	764	6	2122	849	7.5	
				Long Neck	3979	477	3	3183	382	3	2546	611	4	2122	637	4.5	
				Extra Long	—	—	—	3183	382	1.5	2546	509	1.5	2122	509	1.5	
K Gray Cast Iron	≤350MPa	200 (150–300)	VP15TF Low Resistance Type	Standard	3979	796	6	3183	637	8	2546	1019	12.5	2122	849	15	
				Long Neck	3979	796	4	3183	637	4	2546	1019	7.5	2122	849	4.5	
				Extra Long	—	—	—	3183	637	2	2546	1019	4	2122	849	3	
	Ductile Cast Iron	≤500MPa	180 (150–240)	VP15TF Low Resistance Type	Standard	3581	716	6	2865	573	8	2292	917	12.5	1910	764	15
					Long Neck	3581	716	4	2865	573	4	2292	917	7.5	1910	764	4.5
					Extra Long	—	—	—	2865	573	2	2292	917	4	1910	764	1.5
	Ductile Cast Iron	≤800MPa	160 (150–250)	VP15TF Low Resistance Type	Standard	3183	637	6	2546	509	8	2037	815	12.5	1698	679	15
					Long Neck	3183	637	4	2546	509	4	2037	815	7.5	1698	679	4.5
					Extra Long	—	—	—	2546	509	2	2037	815	4	1698	679	1.5
H Hardened Steel	45–50HRC	100 (60–120)	VP15TF Strong Cutting Edge Type	Standard	1989	239	4	1591	191	4	1273	255	6	1061	212	7.5	
				Long Neck	1989	239	2	1591	191	2	1273	255	4	1061	212	3	
				Extra Long	—	—	—	1591	191	1	1273	255	2.5	1061	212	1.5	
	Hardened Steel	50–60HRC	60 (40–100)	VP15TF Strong Cutting Edge Type	Standard	1194	143	4	955	115	4	764	153	6	637	127	7.5
					Long Neck	1194	143	2	955	115	2	764	153	4	637	127	3
					Extra Long	—	—	—	955	115	1	764	153	2.5	637	127	1.5
S Titanium Alloy	≤350HB	50 (30–60)	MP9120	Standard	995	100	4	796	80	4	637	64	6	531	53	7.5	
				Long Neck	995	100	2	796	80	2	637	64	4	531	53	3	
				Extra Long	—	—	—	796	80	1	637	64	2.5	531	53	1.5	
	Heat Resistant Alloy	—	40 (30–60)	MP9120	Standard	796	80	4	637	64	4	510	51	6	425	43	7.5
					Long Neck	796	80	2	637	64	2	510	51	4	425	43	3
					Extra Long	—	—	—	637	64	1	510	51	2.5	425	43	1.5

K

ROTATING TOOLS

ROTATING TOOLS

RECOMMENDED CUTTING CONDITIONS

■ SHOULDER MILLING (Cutting Depth : Small)

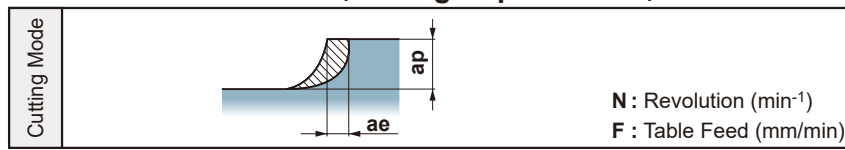

K

ROTATING TOOLS

Cutting Mode	Work Material	Hardness	Cutting Speed (m/min)	Insert Grade, Type	Holder Type	φ16				φ20				φ25				φ30			
						N	F	ap	ae	N	F	ap	ae	N	F	ap	ae	N	F	ap	ae
P	Carbon Steel Alloy Steel	180-280HB	200 (160-250)	MP6120 VP15TF Low Resistance Type	Standard	3979	796	4	6	3183	955	5	8	2546	1273	6	10	2122	1273	7.5	10
					Long Neck	3979	637	4	4	3183	637	5	6	2546	1273	6	7.5	2122	1273	7.5	7.5
					Extra Long	—	—	—	—	3183	382	5	4	2546	1019	6	5	2122	637	7.5	3
		280-350HB	160 (120-200)	MP6120 VP15TF Low Resistance Type	Standard	3183	509	4	6	2546	509	5	8	2037	815	6	10	1698	849	7.5	10
					Long Neck	3183	382	4	4	2546	407	5	6	2037	611	6	7.5	1698	509	7.5	7.5
					Extra Long	—	—	—	—	2546	306	5	4	2037	489	6	5	1698	407	7.5	3
	Pre-Hardened Steel	35-45HRC	160 (120-200)	MP6120 VP15TF Low Resistance Type	Standard	3183	509	4	6	2546	509	5	8	2037	815	6	10	1698	849	7.5	10
					Long Neck	3183	382	4	4	2546	407	5	6	2037	611	6	7.5	1698	679	7.5	7.5
					Extra Long	—	—	—	—	2546	306	5	4	2037	489	6	5	1698	509	7.5	3
	Alloy Tool Steel	≤350HB	160 (120-200)	MP6120 VP15TF Low Resistance Type	Standard	3183	509	4	6	2546	509	5	8	2037	815	6	10	1698	849	7.5	10
					Long Neck	3183	382	4	4	2546	407	5	6	2037	611	6	7.5	1698	509	7.5	7.5
					Extra Long	—	—	—	—	2546	306	5	4	2037	489	6	2.5	1698	407	7.5	1.5
M	Stainless Steel	≤270HB	200 (100-250)	VP15TF Low Resistance Type	Standard	3979	477	4	6	3183	509	5	8	2546	764	6	10	2122	849	7.5	10
					Long Neck	3979	477	4	4	3183	382	5	6	2546	611	6	7.5	2122	849	7.5	7.5
					Extra Long	—	—	—	—	3183	382	5	4	2546	509	6	5	2122	424	7.5	1.5
K	Gray Cast Iron	≤350MPa	200 (150-300)	VP15TF Low Resistance Type	Standard	3979	1592	4	8	3183	1592	5	10	2546	1528	6	10	2122	1485	7.5	10
					Long Neck	3979	1194	4	6	3183	1273	5	8	2546	1528	6	10	2122	1485	7.5	6
					Extra Long	—	—	—	—	3183	955	5	6	2546	1273	6	7.5	2122	1061	7.5	3
	Ductile Cast Iron	≤500MPa	200 (150-280)	VP15TF Low Resistance Type	Standard	3979	1592	4	8	3183	1592	5	10	2546	1528	6	10	2122	1273	7.5	10
					Long Neck	3979	1194	4	6	3183	1273	5	8	2546	1528	6	10	2122	1273	7.5	6
					Extra Long	—	—	—	—	3183	955	5	6	2546	1273	6	7.5	2122	1061	7.5	3
	Ductile Cast Iron	≤800MPa	180 (150-250)	VP15TF Low Resistance Type	Standard	3581	1432	4	8	2865	1433	5	10	2292	1375	6	10	1910	1146	7.5	10
					Long Neck	3581	1074	4	6	2865	1146	5	8	2292	1375	6	10	1910	1146	7.5	6
					Extra Long	—	—	—	—	2865	860	5	6	2292	1146	6	7.5	1910	955	7.5	3
H	Hardened Steel	45-50HRC	100 (60-120)	VP15TF Strong Cutting Edge Type	Standard	1989	239	4	4	1591	191	5	5	1273	255	6	7.5	1061	212	7.5	3
					Long Neck	1989	239	4	2	1591	191	5	3	1273	255	6	4	1061	212	7.5	1.5
					Extra Long	—	—	—	—	1591	191	5	2	1273	204	6	1.5	1061	170	7.5	1
	Hardened Steel	50-60HRC	60 (40-100)	VP15TF Strong Cutting Edge Type	Standard	1194	143	4	4	955	115	5	5	764	153	6	7.5	637	127	7.5	3
					Long Neck	1194	143	4	2	955	115	5	3	764	153	6	4	637	127	7.5	1.5
					Extra Long	—	—	—	—	955	115	5	2	764	122	6	1.5	637	102	7.5	1
S	Titanium Alloy	≤350HB	50 (30-60)	MP9120	Standard	995	299	4	4	796	239	4	5	637	191	6	7.5	531	159	7.5	3
					Long Neck	995	299	2	2	796	239	2	3	637	191	4	4	531	159	3	1.5
					Extra Long	—	—	—	—	796	239	1	2	637	191	2.5	1.5	531	159	1.5	1
	Heat Resistant Alloy	—	40 (30-60)	MP9120	Standard	796	239	4	4	637	191	4	5	510	153	6	7.5	425	128	7.5	3
					Long Neck	796	239	2	2	637	191	2	3	510	153	4	4	425	128	3	1.5
					Extra Long	—	—	—	—	637	191	1	2	510	153	2.5	1.5	425	128	1.5	1

SHOULDER MILLING (Cutting Depth : Large)

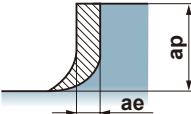
Cutting Mode	
	<p>N : Revolution (min⁻¹)</p> <p>F : Table Feed (mm/min)</p>

Note: Machining Stainless Steels

When up-cut milling stainless steels at large depths and widths of cut, the machined surface is liable to burrs and welding due to chip jamming. For stainless steels, down-cutting (climb milling) is recommended.

Work Material	Hardness	Cutting Speed (m/min)	Insert Grade, Type	Holder Type	φ16				φ20				φ25				φ30				
					N	F	ap	ae	N	F	ap	ae	N	F	ap	ae	N	F	ap	ae	
P Carbon Steel Alloy Steel	180-280HB	200 (160-250)	MP6120 VP15TF Low Resistance Type	Standard	3979	637	8	4	3183	764	10	4	2546	1273	12.5	5	2122	1273	15	4.5	
				Long Neck	3979	477	8	3	3183	509	10	3	2546	1019	12.5	4	2122	849	15	3	
				Extra Long	—	—	—	—	3183	382	10	2	2546	764	12.5	2.5	2122	849	15	1.5	
	280-350HB	160 (120-200)	MP6120 VP15TF Low Resistance Type	Standard	3183	382	8	4	2546	509	10	4	2037	815	12.5	5	1698	849	15	4.5	
				Long Neck	3183	382	8	3	2546	306	10	3	2037	611	12.5	4	1698	509	15	3	
				Extra Long	—	—	—	—	2546	306	10	2	2037	489	12.5	2.5	1698	407	15	1.5	
	Pre-Hardened Steel	35-45HRC	160 (120-200)	MP6120 VP15TF Low Resistance Type	Standard	3183	382	8	4	2546	509	10	4	2037	815	12.5	5	1698	849	15	4.5
					Long Neck	3183	382	8	3	2546	306	10	3	2037	611	12.5	4	1698	509	15	3
					Extra Long	—	—	—	—	2546	306	10	2	2037	489	12.5	2.5	1698	407	15	1.5
	Alloy Tool Steel	≤350HB	160 (120-200)	MP6120 VP15TF Low Resistance Type	Standard	3183	382	8	4	2546	509	10	4	2037	815	12.5	5	1698	849	15	4.5
					Long Neck	3183	382	8	3	2546	306	10	3	2037	611	12.5	2.5	1698	509	15	3
					Extra Long	—	—	—	—	2546	306	10	2	2037	489	12.5	1.5	1698	407	15	1.5
M Stainless Steel	≤270HB	200 (100-250)	VP15TF Low Resistance Type	Standard	3979	477	8	4	3183	509	10	4	2546	764	12.5	10	2122	849	15	10	
				Long Neck	3979	477	8	3	3183	382	10	3	2546	611	12.5	4	2122	509	15	4.5	
				Extra Long	—	—	—	—	3183	382	10	2	2546	489	12.5	1.5	2122	340	15	1.5	
K Gray Cast Iron	≤350MPa	200 (150-300)	VP15TF Low Resistance Type	Standard	3979	1194	8	8	3183	1273	10	8	2546	1273	12.5	10	2122	1485	15	10	
				Long Neck	3979	955	8	5	3183	955	10	4	2546	1273	12.5	7.5	2122	1061	15	4.5	
				Extra Long	—	—	—	—	3183	764	10	2	2546	1019	12.5	1.5	2122	849	15	3	
	Ductile Cast Iron	≤500MPa	200 (150-280)	VP15TF Low Resistance Type	Standard	3979	1194	8	8	3183	1273	10	8	2546	1273	12.5	10	2122	1273	15	10
					Long Neck	3979	955	8	5	3183	955	10	4	2546	1273	12.5	7.5	2122	849	15	4.5
					Extra Long	—	—	—	—	3183	764	10	2	2546	1019	12.5	5	2122	849	15	1.5
	Ductile Cast Iron	≤800MPa	180 (150-250)	VP15TF Low Resistance Type	Standard	3581	1074	8	8	2865	1146	10	8	2292	1146	12.5	10	1910	1146	15	10
					Long Neck	3581	859	8	5	2865	860	10	4	2292	1146	12.5	7.5	1910	764	15	4.5
					Extra Long	—	—	—	—	2865	688	10	2	2292	917	12.5	5	1910	764	15	1.5
	H Hardened Steel	45-50HRC	100 (60-120)	VP15TF Strong Cutting Edge Type	Standard	1989	239	8	2	1591	191	10	3	1273	255	12.5	4	1061	212	15	3
					Long Neck	1989	239	8	1	1591	191	10	2	1273	204	12.5	1.5	1061	106	15	1.5
					Extra Long	—	—	—	—	1591	191	10	1	—	—	—	—	—	—	—	—
50-60HRC		60 (40-100)	VP15TF Strong Cutting Edge Type	Standard	1194	143	8	2	955	115	10	3	764	153	12.5	4	637	127	15	3	
				Long Neck	1194	143	8	1	955	115	10	2	764	122	12.5	1.5	637	64	15	1.5	
				Extra Long	—	—	—	—	955	115	10	1	—	—	—	—	—	—	—	—	
S Titanium Alloy	≤350HB	50 (30-60)	MP9120	Standard	995	199	4	2	796	159	4	3	637	127	6	4	531	106	7.5	3	
				Long Neck	995	199	2	1	796	159	2	2	637	127	4	1.5	531	106	3	1.5	
				Extra Long	—	—	—	—	796	159	1	1	637	127	2.5	—	531	106	1.5	—	
	Heat Resistant Alloy	—	40 (30-60)	MP9120	Standard	796	159	4	2	637	127	4	3	510	102	6	4	425	85	7.5	3
					Long Neck	796	159	2	1	637	127	2	2	510	102	4	1.5	425	85	3	1.5
					Extra Long	—	—	—	—	637	127	1	1	510	102	2.5	—	425	85	1.5	—

K

ROTATING TOOLS

ROTATING TOOLS

BALL NOSE END MILL



SRM2 $\phi 40$
 $\phi 50$

- P M **K** N S H

ROTATING TOOLS

K



● Weldon Type (Fig.1)

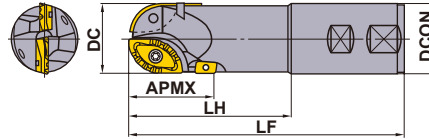

● Weldon Type (Fig.2)

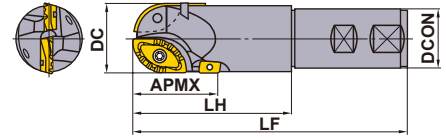

● Weldon Type (Fig.3)

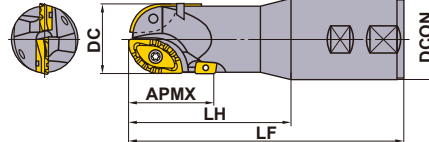

● Weldon Type (Fig.4)

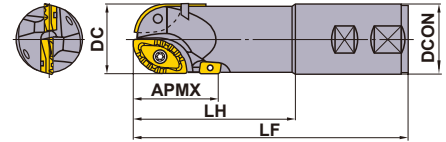

● Morse Taper Type (Fig.5)

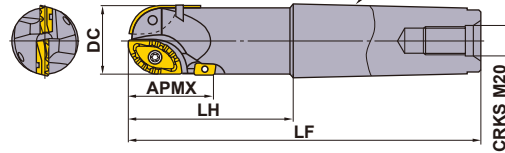

● Morse Taper Type (Fig.6)

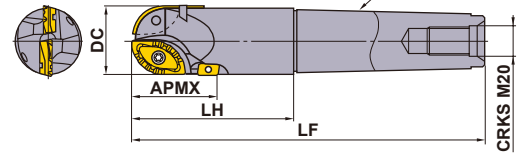

● Combination Type (Fig.7)

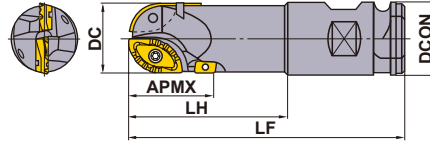

● Straight Type (Fig.8)

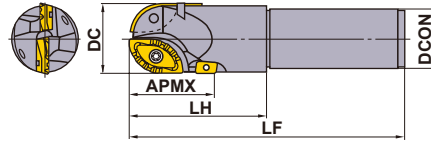

Right hand tool holder only.

Type	Order Number	Stock	Number of Teeth	Dimensions (mm)					Type (Fig.)	*1		*1		Insert			
				*2 RE	DC	DCON	LF	LH		APMX	Inner/Outer	Peripheral	Inner/Outer	Peripheral	Inner	Outer	Peripheral
Weldon Type	Short	●	2	20	40	40	190	120	54	1	TS6S	TS43	TKY30T	TKY15F	SRG40C	SRG40E	APMT1604 PDER-02
		□	2	20	40	50	200	120	54	3	TS6S	TS43	TKY30T	TKY15F	SRG40C	SRG40E	APMT1604 PDER-02
	Medium	●	2	25	50	40	190	120	63	2	TS6	TS43	TKY30T	TKY15F	SRG50C	SRG50E	APMT1604 PDER-02
		□	2	25	50	50	200	120	63	4	TS6	TS43	TKY30T	TKY15F	SRG50C	SRG50E	APMT1604 PDER-02
		□	2	20	40	40	220	150	54	1	TS6S	TS43	TKY30T	TKY15F	SRG40C	SRG40E	APMT1604 PDER-02
		□	2	20	40	50	230	150	54	3	TS6S	TS43	TKY30T	TKY15F	SRG40C	SRG40E	APMT1604 PDER-02
Morse Taper Type	Short	□	2	20	40	—	256	120	54	5	TS6S	TS43	TKY30T	TKY15F	SRG40C	SRG40E	APMT1604 PDER-02
		★	2	25	50	—	256	120	63	6	TS6	TS43	TKY30T	TKY15F	SRG50C	SRG50E	APMT1604 PDER-02
	Medium	●	2	20	40	—	286	150	54	5	TS6S	TS43	TKY30T	TKY15F	SRG40C	SRG40E	APMT1604 PDER-02
		★	2	25	50	—	286	150	63	6	TS6	TS43	TKY30T	TKY15F	SRG50C	SRG50E	APMT1604 PDER-02
Combination Type	Short	★	2	20	40	50.8	200	120	54	7	TS6S	TS43	TKY30T	TKY15F	SRG40C	SRG40E	APMT1604 PDER-02
		★	2	25	50	50.8	200	120	63	7	TS6	TS43	TKY30T	TKY15F	SRG50C	SRG50E	APMT1604 PDER-02
	Long	★	2	20	40	50.8	250	170	54	7	TS6S	TS43	TKY30T	TKY15F	SRG40C	SRG40E	APMT1604 PDER-02
		★	2	25	50	50.8	250	170	63	7	TS6	TS43	TKY30T	TKY15F	SRG50C	SRG50E	APMT1604 PDER-02
		★	2	25	50	50.8	300	220	63	7	TS6	TS43	TKY30T	TKY15F	SRG50C	SRG50E	APMT1604 PDER-02
Straight Type	Short	★	2	20	40	42	200	100	54	8	TS6S	TS43	TKY30T	TKY15F	SRG40C	SRG40E	APMT1604 PDER-02
		★	2	25	50	42	200	100	63	8	TS6	TS43	TKY30T	TKY15F	SRG50C	SRG50E	APMT1604 PDER-02
	Medium	★	2	20	40	42	250	150	54	8	TS6S	TS43	TKY30T	TKY15F	SRG40C	SRG40E	APMT1604 PDER-02
		★	2	25	50	42	250	100	63	8	TS6	TS43	TKY30T	TKY15F	SRG50C	SRG50E	APMT1604 PDER-02

*1 Clamp Torque (N · m) : TS43=6.0, TS6=10.0, TS6S=10.0 *2 RE is shown for insert corner R.

● : Inventory maintained. ★ : Inventory maintained in Japan.

□ : Non stock, produced to order only. (10 inserts in one case) (Inserts with asterisk (★) are available in 2 piece in one case)

INSERTS

Work Material		P	Steel	Cutting Conditions :											
Work Material		K	Cast Iron	● : Stable Cutting ● : General Cutting ✖ : Unstable Cutting											
Type	Shape	Order Number	Class	Coated				Dimensions (mm)					Geometry		
				F7030	VP15TF	VP20RT	VP30RT	RE	L	LE	W1	S		BS	AN
Inner		*2 SRG40C	G	●	●	●	●	20	36	—	20.5	8.0	—	11°	
		*2 SRG50C	G	●	●	●	●	25	40	—	26	8.5	—	11°	
Outer		*2 SRG40E	G	●	●	●	●	20	32	—	16.6	8.0	—	11°	
		*2 SRG50E	G	●	●	●	●	25	35.8	—	20	8.5	—	11°	
*1 Peripheral	Strong Cutting Edge Type	APMT1604PDER-H2	M	●	●			0.8	11.71	14	9.525	4.76	1.4	11°	
	Low Resistance Type	APMT1604PDER-M2	M	●	●			0.8	17.10	14	9.525	4.76	1.4	11°	

(Low-resistance inner or outer inserts are precision M class type.)

*1 Selection guide for peripheral cutting edges : The first recommendation is the super sharp M breaker (APMT....PDER-M2).

When cutting edge strength is particularly important, use the H breaker (APMT....PDER-H2).

RECOMMENDED CUTTING CONDITIONS

Cutting Mode	A : Slot Milling	B : Shoulder Milling (Standard Type)	C : Shoulder Milling (Long Cutting Edge Type)

Work Material	Hardness	Grade	Cutting Speed (m/min)	Feed per Tooth (mm/t.)	Cutting Mode
P	Alloy Tool Steel	VP20RT VP30RT	160 (120-200)	0.12 (0.08-0.2)	A
				0.2 (0.1-0.4)	B
				0.15 (0.1-0.3)	C
	Alloy Tool Steel	VP20RT VP30RT	200 (160-250)	0.2 (0.1-0.3)	A
				0.3 (0.1-0.4)	B
				0.2 (0.1-0.4)	C
	Cast Tool Steel	VP20RT	200 (160-250)	0.2 (0.1-0.3)	A
				0.3 (0.1-0.4)	B
				0.2 (0.1-0.4)	C
	Cast Tool Steel	VP15TF VP20RT	200 (160-300)	0.2 (0.1-0.3)	A
				0.3 (0.1-0.45)	B
				0.2 (0.1-0.4)	C
K	Ductile Cast Iron	VP15TF VP20RT	200 (160-300)	0.25 (0.1-0.4)	A
				0.35 (0.1-0.45)	B
				0.25 (0.1-0.45)	C
	Gray Cast Iron	VP15TF VP20RT	200 (160-300)	0.25 (0.1-0.4)	A
				0.35 (0.1-0.45)	B
				0.25 (0.1-0.4)	C

ROTATING TOOLS

CHAMFER MILLING



CESP/CFSP/CGSP

P M **K** N S H

K

ROTATING TOOLS

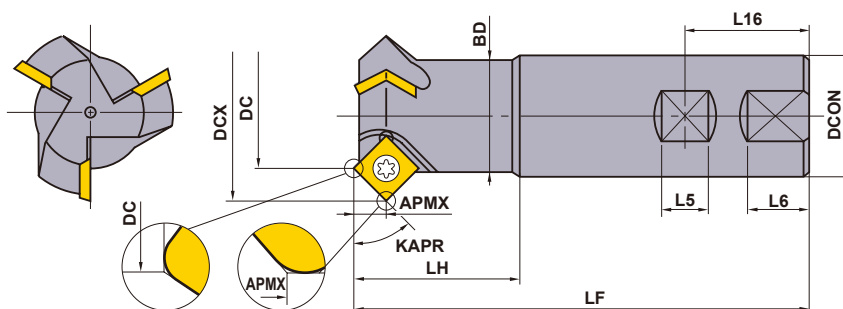

Right hand tool holder only.

Order Number	Stock	Number of Teeth	Dimensions (mm)										* Clamp Screw	① Wrench	Insert	
			KAPR	DC	DCX	LF	DCON	BD	LH	L16	L5	L6				APMX
CESPR081S20	●	1	60°	8	19.6	110	20	19.5	40	25	11	—	10.2	TS52	①TKY25R	SPMW1203○○
CESPR161S20	●	1	60°	16	27.8	110	20	19.5	40	25	11	—	10.2	TS5	①TKY25R	SPMW1203○○
CESPR323S32	●	3	60°	32	43.8	125	32	31.5	45	36	14	19	10.2	TS5	①TKY25R	SPMW1203○○
CFSPR041S16S	●	1	45°	4	15.7	85	16	14.4	25	24	10	—	5.9	TS4	②TKY15F	SPMW0903○○
CFSPR041S16L	●	1	45°	4	15.7	110	16	14.4	50	24	10	—	5.9	TS4	②TKY15F	SPMW0903○○
CFSPR081S20	●	1	45°	8	24.6	110	20	19.5	40	25	11	—	8.3	TS5	①TKY25R	SPMW1203○○
CFSPR161S20	●	1	45°	16	32.6	110	20	19.5	40	25	11	—	8.3	TS5	①TKY25R	SPMW1203○○
CFSPR323S32	●	3	45°	32	48.6	125	32	31.5	45	36	14	19	8.3	TS5	①TKY25R	SPMW1203○○
CGSPR081S20	●	1	30°	8	28.4	110	20	19.5	40	25	11	—	5.9	TS5	①TKY25R	SPMW1203○○
CGSPR161S20	●	1	30°	16	36.4	110	20	19.5	40	25	11	—	5.9	TS5	①TKY25R	SPMW1203○○
CGSPR323S32	●	3	30°	32	52.4	125	32	31.5	45	36	14	19	5.9	TS5	①TKY25R	SPMW1203○○

* Clamp Torque (N · m) : TS4=3.5, TS5=7.5, TS52=7.5

● : Inventory maintained. ★ : Inventory maintained in Japan.
(10 inserts in one case)

INSERTS

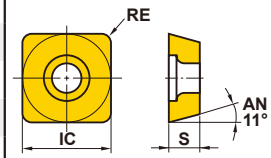
Work Material	P	Steel											Cutting Conditions :		
	K	Cast Iron											● : Stable Cutting	● : General Cutting	✦ : Unstable Cutting
Shape	Order Number	Class	Honing	Coated			Cermet		Carbide		Dimensions (mm)			Geometry	
				VP15TF	UP20M		NX2525	NX4545	UTi20T	HTi10	IC	S	RE		
	SPMW090304	M	E*	★	●			●	●	●	●	9.525	3.18	0.4	
	SPMW090308	M	E*	★	●			★	★	●	●	9.525	3.18	0.8	
	SPMW120304	M	E*	★	●			●	●	●	●	12.7	3.18	0.4	
	SPMW120308	M	E*	★	●			●	●	●	●	12.7	3.18	0.8	

* NX2525 and NX4545 insert honing is "T" type.

K

ROTATING TOOLS

RECOMMENDED CUTTING CONDITIONS

Work Material	Hardness	Grade	Cutting Speed (m/min)	Feed per Tooth (mm/t.)	
				Chamfer Milling	Face Milling
P Carbon Steel Alloy Steel	180–280HB	UTi20T	80 (60–100)	0.4	0.15
		UP20M	130 (100–160)	0.4	0.2
		NX4545	130 (100–160)	0.4	0.2
	280–350HB	UTi20T	80 (60–100)	0.3	0.15
K Cast Iron	Tensile Strength ≤450MPa	UTi20T	100 (85–120)	0.5	0.25
		HTi10	100 (85–120)	0.5	0.25

● Revolution (min⁻¹)=(1000 x Cutting Speed)÷(3.14 x DC)

● Table Feed (mm/min)=Feed per Tooth x Number of Teeth x Cutter Revolution

ROTATING TOOLS

T-SLOT MILLING



TSMP

- P
- M
- K
- N
- S
- H

K

ROTATING TOOLS

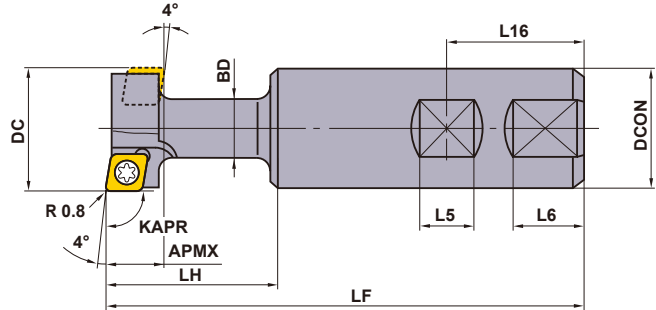
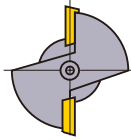

KAPR :90°

Right hand tool holder only.

Order Number	T Slot Nomenclature	Stock	R	Number of Teeth	Dimensions (mm)							Clamp Screw	Wrench	Insert		
					DC	LF	DCON	BD	LH	L16	L5				L6	APMX
TSMPR252S25	14	●	2	2	25	112	25	12.5	33.2	32	12	17	11	TS3	①TKY08D	MPMW070308
TSMPR322S32	18	●	2	2	32	120	32	16	41.2	36	14	19	14	TS4	②TKY15R	MPMW090308
TSMPR402S32	22	●	2	2	40	130	32	20	51.2	36	14	19	18	TS5	②TKY25R	MPMW120408

* Clamp Torque (N • m) : TS3=1.0, TS4=3.5, TS5=7.5

● : Inventory maintained.
(10 inserts in one case)

INSERTS

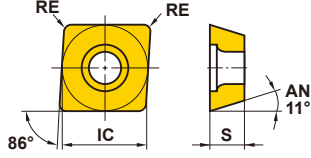
Work Material	P	Steel	Carbide	Cutting Conditions :			Geometry
	K	Cast Iron		●	Stable Cutting	●	
Shape	Order Number	Class	UTi20T	Dimensions (mm)			Geometry
				IC	S	RE	
	MPMW070308	M	●	7.94	3.18	0.8	
	MPMW090308	M	●	9.525	3.18	0.8	
	MPMW120408	M	●	12.7	4.76	0.8	

K

ROTATING TOOLS

RECOMMENDED CUTTING CONDITIONS

Work Material	Hardness	Grade	Cutting Speed (m/min)	Feed (mm/rev)
P Carbon Steel Alloy Steel	180–280HB	UTi20T	130 (100–160)	0.15 (0.1–0.2)
	280–350HB	UTi20T	80 (60–100)	0.1 (0.05–0.15)
K Cast Iron	Tensile Strength ≤450MPa	UTi20T	100 (80–120)	0.15 (0.1–0.2)

● Revolution (min⁻¹)=(1000 x Cutting Speed)÷(3.14 x DC)

CAUTION FOR USE

- When T slot machining steel, the workpiece must be pre-machined as shown in the drawing, so as to ensure smooth chip evacuation.
- Slots to be machined must be free from chips for smooth machining.

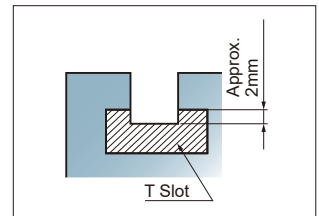

ROTATING TOOLS

VERTICAL FEED MILLING



PMF

- P
- M
- K
- N
- S
- H

K

ROTATING TOOLS

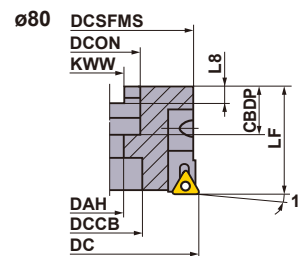
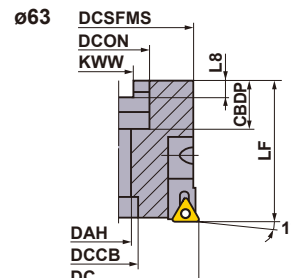
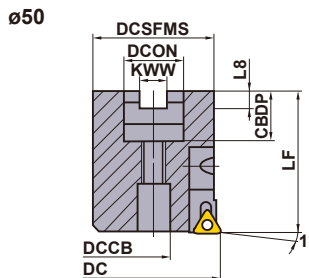

Right hand tool holder only.

Order Number	Stock	Number of Teeth	Dimensions (mm)										Cartridge	Clamp Screw *	Radial Screw	Set Bolt (Cartridge) *	Wrench	Wrench	Set Bolt	Insert
			DC	LF	DCON	CBBDP	DAH	DCCB	KWW	L8	DCSFMS									
PMF05004A22R	★	4	50	63	22	20	—	12	10.4	6.3	48	PMFA13R	TS254	TSS04005	HBH06012	TKY08F	HKY40R HKY50R	⊙HDS10031	TPEW 1303 ZP [○] R2	
PMF06306A22R	★	6	63	63	22	20	11	18	10.4	6.3	60	PMFA13R	TS254	TSS04005	HBH06012	TKY08F	HKY40R	⊙HSC10050		
PMF08008A27R	●	8	80	50	27	23	13.5	30	12.4	7	75	PMFA13R	TS254	TSS04005	HBH06012	TKY08F	HKY40R	⊙HSC12035		

* Clamp Torque (N · m) : TS254=1.0, HBH06012=8.5

INSERTS

Work Material	P Steel K Cast Iron	Cutting Conditions :				Cutting Conditions :				Geometry				
		●	●	●	●	●	●	●	●					
Shape	Order Number	Class	Coated		MB710	Dimensions (mm)				IC	LE	S	BS	
			VP15TF	AP10H		IC	LE	S	BS					
 	TPEW1303ZPER2	E	●	●		7.94	—	3.18	2	 	7.94	1.5	3.18	2
	* TPEW1303ZPTR2	E			●									

● : Inventory maintained. ★ : Inventory maintained in Japan.

(10 inserts in one case) (CBN inserts are available in 1 piece in one case.)

RECOMMENDED CUTTING CONDITIONS

Work Material	Hardness	Grade	Cutting Speed (m/min)	Feed per Tooth (mm/t.)
P Carbon Steel Alloy Steel	180–280HB	VP15TF	250 (150–350)	0.1 (0.05–0.15)
	280–380HB	VP15TF	200 (100–300)	
K Gray Cast Iron	Tensile Strength ≤350MPa	AP10H	350 (200–500)	0.1 (0.05–0.15)
		MB710	1500 (1000–2000)	

Work Material	Hardness	Grade	Cutting Speed (m/min)	Feed per Tooth (mm/t.)
K Ductile Cast Iron	Tensile Strength 360–500MPa	AP10H	²⁵⁰ (150–350)	0.1 (0.05–0.15)
		MB710	¹⁰⁰⁰ (800–1200)	
Ductile Cast Iron	Tensile Strength 500–800MPa	AP10H	²⁰⁰ (100–300)	0.1 (0.05–0.15)
		MB710	¹⁰⁰⁰ (800–1200)	

● Revolution (min⁻¹)=(1000 x Cutting Speed)÷(3.14 x DC)

● Table Feed (mm/min)=Feed per Tooth x Number of Teeth x Cutter Revolution

Note 1) Recommended radial depth of cut is 0.1 mm.

Note 2) 2 directional vertical cutting is recommended for efficiency.

Note 3) For crossfeed cutting, the feed per tooth should be reduced to less than 0.05(mm/t.).

K

ROTATING TOOLS

ROTATING TOOLS

VERTICAL FEED MILLING



PMR

- P
M
K
N
S
H

K

ROTATING TOOLS

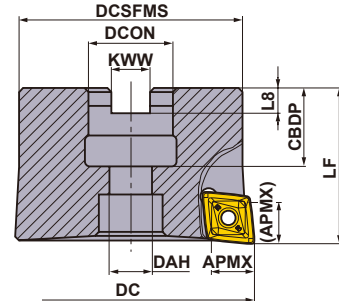

Right hand tool holder only.

Type	Order Number	Stock	Number of Teeth	Dimensions (mm)									Insert
				R	DC	LF	DCON	CBDP	DAH	DCSFMS	KWW	L8	
Metric	PMR405003A22R	★	3	50	40	22	20	11	45	10.4	6.3	11	CPMT1205ZPEN-M2/3
	PMR405203A22R	□	3	52	40	22	20	11	47	10.4	6.3	11	CPMT1205ZPEN-M2/3
	PMR406304A22R	★	4	63	40	22	20	11	57	10.4	6.3	11	CPMT1205ZPEN-M2/3
	PMR406604A27R	□	4	66	50	27	23	13	60	12.4	7	11	CPMT1205ZPEN-M2/3
Inch	PMR405003BR	★	3	50	40	22.225	19	11	45	8.4	5	11	CPMT1205ZPEN-M2/3
	PMR406304BR	★	4	63	40	22.225	19	11	57	8.4	5	11	CPMT1205ZPEN-M2/3

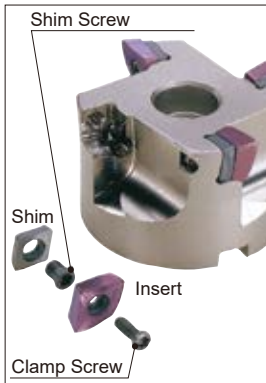

SPARE PARTS

Tool Holder Number						
	Shim	Shim Screw	Clamp Screw	Wrench (Insert)	Wrench (Shim)	Set Bolt
PMR405003A22R	STPMR4N	WCS503507H	①TPS35	①TIP15T	HKY35R	HSC10035
PMR405203A22R	STPMR4N	WCS503507H	①TPS35	①TIP15T	HKY35R	HSC10035
PMR406304A22R	STPMR4N	WCS503507H	①TPS35	①TIP15T	HKY35R	HSC10035
PMR406604A22R	STPMR4N	WCS503507H	①TPS35	①TIP15T	HKY35R	HSC10035
PMR405003BR	STPMR4N	WCS503507H	①TPS35	①TIP15T	HKY35R	HSC10035
PMR406304BR	STPMR4N	WCS503507H	①TPS35	①TIP15T	HKY35R	HSC10035

* Clamp Torque (N • m) : TPS35=3.5, CSF401260T=5.0, WCS503507H=5.0, WCS604010H=7.0

● : Inventory maintained. ★ : Inventory maintained in Japan.

□ : Non stock, produced to order only. (10 inserts in one case)

ROTATING TOOLS

MULTI FUNCTIONAL MILLING



ARP

- P
- M
- K
- N
- S
- H

ROTATING TOOLS



Fig.1

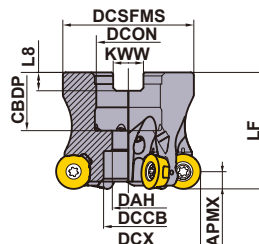
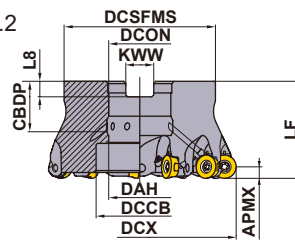

Fig.2



Right hand (R) only for the standard.

Cutter Diameter (mm)	Set Bolt	Geometry
φ40	HSC08025H	
φ50, φ63	HSC10030H	
φ80	HSC12035H	
φ100	MBA16033H	

ARBOR TYPE

GAMP: +4° GAMF: -6°

Type	Cutting Edge R (APMX)	Order Number	Stock R	Coolant Hole	Number of Teeth	Dimensions (mm)										WT* (kg)	Max. Depth of Cut (mm)			RMPX	Fig.
						DCX	DCSFMS	LF	DCON	CBDP	DAH	DCCB	KWW	L8	APMX		A1	AZ			
Fine Pitch	5	ARP5P-040A05AR	●	○	5	40	34	40	16	18	9	14	8.4	5.6	0.15	5.0	2.0	1.30	2.8°	1	
		ARP5P-042A05AR	●	○	5	42	34	40	16	18	9	14	8.4	5.6	0.16	5.0	2.5	1.4	2.8°	1	
		ARP5P-050A06AR	●	○	6	50	45	40	22	20	11	17	10.4	6.3	0.27	5.0	2.0	1.85	2.9°	1	
		ARP5P-052A06AR	●	○	6	52	45	40	22	20	11	17	10.4	6.3	0.29	5.0	2.5	2	3.0°	1	
		ARP5P-063A07AR	●	○	7	63	50	40	22	20	11	17	10.4	6.3	0.46	5.0	2.5	2.50	3.0°	1	
Extra Fine Pitch	5	ARP5P-042A06AR	●	○	6	42	34	40	16	18	9	14	8.4	5.6	1.6	5.0	2.5	1.4	2.8°	1	
		ARP5P-050A07AR	●	○	7	50	45	40	22	20	11	17	10.4	6.3	0.27	5.0	2.0	1.85	2.9°	1	
		ARP5P-052A07AR	●	○	7	52	45	40	22	20	11	17	10.4	6.3	0.29	5.0	2.5	2	3.0°	1	
		ARP5P-063A08AR	●	○	8	63	50	40	22	20	11	17	10.4	6.3	0.46	5.0	2.5	2.50	3.0°	1	
Fine Pitch	6	ARP6P-040A04AR	●	○	4	40	34	40	16	18	9	13.4	8.4	5.6	0.15	6.0	2.0	1.15	2.7°	1	
		ARP6P-050A05AR	●	○	5	50	45	40	22	20	11	17	10.4	6.3	0.26	6.0	2.0	1.70	2.9°	1	
		ARP6P-052A05AR	●	○	5	52	45	40	22	20	11	17	10.4	6.3	0.28	6.0	2.5	1.8	2.9°	1	
		ARP6P-063A06AR	●	○	6	63	50	40	22	20	11	17	10.4	6.3	0.44	6.0	2.5	2.50	3.1°	1	
		ARP6P-066X06AR	●	○	6	66	56	50	27	23	13	20	12.4	7	0.64	6.0	2.5	2.5	2.9°	1	
		ARP6P-080A08AR	●	○	8	80	56	50	27	23	13	20	12.4	7	0.88	6.0	2.5	2.50	2.3°	1	
		ARP6P-100B09AR	●	○	9	100	78	50	32	26	32	45	14.4	8	1.47	6.0	2.5	2.50	1.7°	2	
Extra Fine Pitch	6	ARP6P-050A06AR	●	○	6	50	45	40	22	20	11	17	10.4	6.3	0.25	6.0	2.0	1.70	2.9°	1	
		ARP6P-052A06AR	●	○	6	52	45	40	22	20	11	17	10.4	6.3	0.27	6.0	2.5	1.8	2.9°	1	
		ARP6P-063A07AR	●	○	7	63	50	40	22	20	11	17	10.4	6.3	0.44	6.0	2.5	2.50	3.1°	1	
		ARP6P-066X07AR	●	○	7	66	56	50	27	23	13	20	12.4	7	0.64	6.0	2.5	2.5	2.9°	1	
		ARP6P-080A09AR	●	○	9	80	56	50	27	23	13	20	12.4	7	0.88	6.0	2.5	2.50	2.3°	1	
		ARP6P-100B11AR	●	○	11	100	78	50	32	26	32	45	14.4	8	1.45	6.0	2.5	2.50	1.7°	2	

* WT : Tool Weight

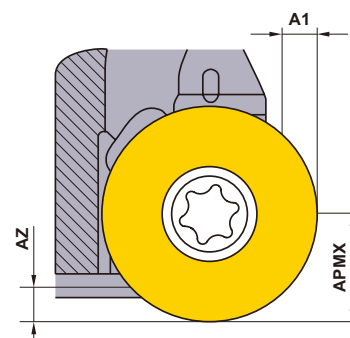

● : Inventory maintained. ★ : Inventory maintained in Japan.

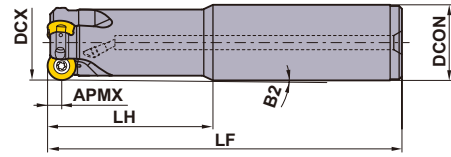

Fig.1

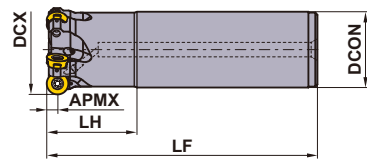

Fig.2





SHANK TYPE

GAMP: +4° GAMF: -6° -7°

Type	Cutting Edge R (APMX)	Order Number	Stock R	Coolant Hole	Number of Teeth	Dimensions (mm)					WT* (kg)	Max. Depth of Cut (mm)			RMPX	Fig.
						DCX	DCON	LF	LH	B2		APMX	A1	AZ		
Standard	5	ARP5PR2503SA25M	★	○	3	25	25	140	60	1.10°	0.42	5.0	1.0	0.40	1.8°	1
		ARP5PR3204SA32M	★	○	4	32	32	150	70	0.92°	0.77	5.0	1.0	0.65	1.9°	1
Long	5	ARP5PR2502SA25L	★	○	2	25	25	180	80	0.80°	0.56	5.0	1.0	0.40	1.8°	1
		ARP5PR3203SA32L	★	○	3	32	32	200	120	0.51°	1.01	5.0	1.0	0.65	1.9°	1
Standard	6	ARP6PR3203SA32M	★	○	3	32	32	150	70	0.94°	0.76	6.0	1.0	0.60	2.0°	1
		ARP6PR4004SA32M	★	○	4	40	32	150	50	-	0.85	6.0	2.5	1.15	2.7°	2
		ARP6PR5005SA42M	★	○	5	50	42	150	50	-	1.47	6.0	2.5	1.70	2.9°	2
Long	6	ARP6PR3202SA32L	★	○	2	32	32	200	120	0.52°	1.00	6.0	1.0	0.60	2.0°	1
		ARP6PR4003SA32L	★	○	3	40	32	250	50	-	1.48	6.0	2.5	1.15	2.7°	2
		ARP6PR5004SA42L	★	○	4	50	42	250	50	-	2.53	6.0	2.5	1.70	2.9°	2

* WT : Tool Weight

SPARE PARTS

Tool Holder Number	 *1			
	Insert Screw	Wrench	Anti-seize Lubricant	Insert
ARP5	TPS351B	TIP10D	MK1KS	RPOT1040M0E4-○
ARP6	TPS4	TIP15D	MK1KS	RPOT1248M0E4-○

*1 Clamp Torque (N · m) : TPS351B=2.5, TPS4=3.5

*2 Coolant nozzles are available with varying diameters for adjusting coolant pressure. Select nozzles as required by the specification.

	≤1Mpa (≤20 l/min.)	←Standard→	≥5Mpa (≥30 l/min.)	≥7Mpa (≥50 l/min.)
Nozzle Dia.	ø0.6mm	ø0.8mm	ø1.2mm	ø1.6mm
Order Number	HSD04004H06	HSD04004H08	HSD04004H12	HSD04004H16

* Clamp Torque (N · m) : HSD0400H○=1.5

*3 The part number for a blank screw without a through nozzle is HSS04004.

ROTATING TOOLS

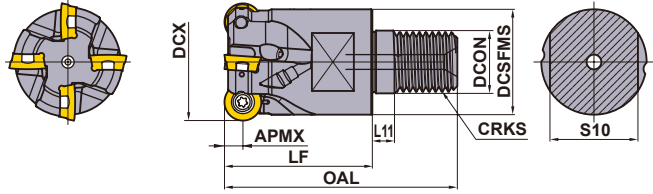

ROTATING TOOLS

K

■ SCREW-IN TYPE

GAMP: +4° GAMF: -6° - -7°

Type	Cutting Edge R (APMX)	Order Number	Stock R	Coolant Hole	Number of Teeth	Dimensions (mm)							* WT (kg)	Max. Depth of Cut (mm)			RMPX	
						DCX	DCON	DCSFMS	OAL	LF	L11	S10		CRKS	APMX	A1		AZ
Standard	5	ARP5PR2502AM1235	●	○	2	25	12.5	23.5	57	35	6	19	M12	0.10	5.0	-	0.40	1.8°
		ARP5PR3203AM1640	●	○	3	32	17.0	28.5	63	40	6	24	M16	0.16	5.0	1.0	0.65	1.9°
Fine Pitch	5	ARP5PR2503AM1235	●	○	3	25	12.5	23.5	57	35	6	19	M12	0.09	5.0	-	0.40	1.8°
		ARP5PR3204AM1640	●	○	4	32	17.0	28.5	63	40	6	24	M16	0.15	5.0	1.0	0.65	1.9°
Standard	6	ARP6PR3202AM1640	●	○	2	32	17.0	28.5	63	40	6	24	M16	0.18	6.0	1.0	0.60	2.0°
		ARP6PR4003AM1640	●	○	3	40	17.0	28.5	63	40	6	24	M16	0.20	6.0	2.5	1.15	2.7°
Fine Pitch	6	ARP6PR3203AM1640	●	○	3	32	17.0	28.5	63	40	6	24	M16	0.17	6.0	1.0	0.60	2.0°
		ARP6PR4004AM1640	●	○	4	40	17.0	28.5	63	40	6	24	M16	0.20	6.0	2.5	1.15	2.7°

* WT : Tool Weight

Note 1) For screw-in type arbors, refer to page K244.

● : Inventory maintained.
(10 inserts in one case)

INSERTS

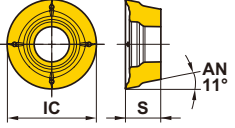
Work Material		M	Stainless Steels		G	G	C	C	Cutting Conditions (Guide) :				Honing :	
		S	Heat-resistant Alloys, Titanium Alloys						●	Stable Cutting		●		General Cutting
Shape	Holder	Order Number	Type	Class	Honing	Coated				Dimensions (mm)		APMX (mm)		Geometry
						MC7020	MP7130	MP9130	NEW MP9140	IC	S	4 Seats	8 Seats	
	ARP5	RPHT1040M0E4-L	Low Resistance, High Precision	H	E	●	●	●		10	3.97	5.0	-	
		RPMT1040M0E4-L	Low Resistance	M	E	●	●	●		10	3.97	5.0	-	
		NEW RPMT1040M0E8-L1	Low Resistance, 8 Seats	M	E	●	●	●	●	10	3.97	5.0	1.4	
		NEW RPMT1040M0E4-L2	Low Resistance, High Rigidity	M	E				●	10	3.97	5.0	-	
		RPHT1040M0E4-M	General, High Precision	H	E	●	●	●		10	3.97	5.0	-	
		RPMT1040M0E4-M	General Purpose	M	E	●	●	●		10	3.97	5.0	-	
		NEW RPMT1040M0E8-M1	General, 8 Seats	M	E	●	●	●	●	10	3.97	5.0	1.4	
		NEW RPMT1040M0E4-M2	General, High Rigidity	M	E				●	10	3.97	5.0	-	
		RPHT1040M0E4-R	Reinforced Edge, High Precision	H	E	●	●	●		10	3.97	5.0	-	
		RPMT1040M0E4-R	Reinforced Edge	M	E	●	●	●		10	3.97	5.0	-	
	NEW RPMT1040M0E8-R1	Reinforced Edge, 8 Seats	M	E	●	●	●	●	10	3.97	5.0	1.4		
	ARP6	RPHT1248M0E4-L	Low Resistance, High Precision	H	E	●	●	●		12	4.76	6.0	-	
		RPMT1248M0E4-L	Low Resistance	M	E	●	●	●		12	4.76	6.0	-	
		NEW RPMT1248M0E8-L1	Low Resistance, 8 Seats	M	E	●	●	●	●	12	4.76	6.0	1.7	
		NEW RPMT1248M0E4-L2	Low Resistance, High Rigidity	M	E				●	12	4.76	6.0	-	
		RPHT1248M0E4-M	General, High Precision	H	E	●	●	●		12	4.76	6.0	-	
		RPMT1248M0E4-M	General Purpose	M	E	●	●	●		12	4.76	6.0	-	
		NEW RPMT1248M0E8-M1	General, 8 Seats	M	E	●	●	●	●	12	4.76	6.0	1.7	
		NEW RPMT1248M0E4-M2	General, High Rigidity	M	E				●	12	4.76	6.0	-	
		RPHT1248M0E4-R	Reinforced Edge, High Precision	H	E	●	●	●		12	4.76	6.0	-	
RPMT1248M0E4-R		Reinforced Edge	M	E	●	●	●		12	4.76	6.0	-		
NEW RPMT1248M0E8-R1	Reinforced Edge, 8 Seats	M	E	●	●	●	●	12	4.76	6.0	1.7			

● = NEW

K
ROTATING TOOLS

Depth of cut (ap) for 8 indexing face insert

8 indexing face type inserts can also be used at the same depth of cut as the 4 face type insert.

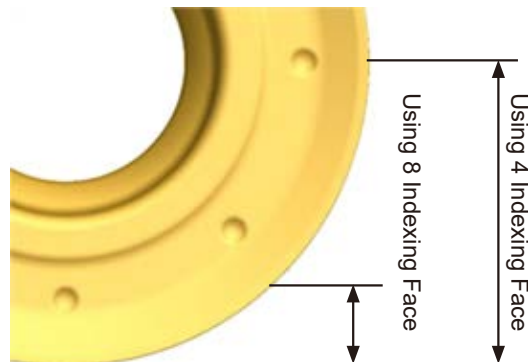

ARBORS	> K244
SPARE PARTS	> N001
TECHNICAL DATA	> P001

RECOMMENDED CUTTING CONDITIONS

■ Dry cutting

	Work Material	Hardness	Grade	V _c (m/min)	f _z (mm/t.)
M	Austenitic Stainless Steel	≤200HB	MC7020	220 (170–270)	0.2 (0.1–0.35)
			MP7130	200 (150–250)	0.2 (0.1–0.35)
	Austenitic Stainless Steel	>200HB	MC7020	190 (140–240)	0.2 (0.1–0.35)
			MP7130	170 (120–220)	0.2 (0.1–0.35)
	Two-phase Stainless Steel	≤280HB	MC7020	180 (130–230)	0.2 (0.1–0.35)
			MP7130	160 (110–210)	0.2 (0.1–0.35)
	Ferritic and Martensitic Stainless Steel	≤200MPa	MC7020	240 (190–290)	0.2 (0.1–0.35)
			MP7130	200 (150–250)	0.2 (0.1–0.35)
	Ferritic and Martensitic Stainless Steel	>200HB	MC7020	240 (190–290)	0.2 (0.1–0.35)
			MP7130	200 (150–250)	0.2 (0.1–0.35)
	Hardened Stainless Steel	<450HB	MC7020	170 (120–220)	0.2 (0.1–0.35)
			MP7130	150 (100–200)	0.2 (0.1–0.35)

■ Wet cutting

	Work Material	Hardness	Grade	V _c (m/min)	f _z (mm/t.)
M	Austenitic Stainless Steel	≤200HB	MC7020	150 (100–200)	0.2 (0.1–0.35)
			MP7130	130 (80–180)	0.2 (0.1–0.35)
	Austenitic Stainless Steel	>200HB	MC7020	120 (70–170)	0.2 (0.1–0.35)
			MP7130	100 (80–150)	0.2 (0.1–0.35)
	Two-phase Stainless Steel	≤280HB	MC7020	120 (70–170)	0.2 (0.1–0.35)
			MP7130	100 (80–150)	0.2 (0.1–0.35)
	Ferritic and Martensitic Stainless Steel	≤200MPa	MC7020	170 (120–220)	0.2 (0.1–0.35)
			MP7130	130 (80–180)	0.2 (0.1–0.35)
	Ferritic and Martensitic Stainless Steel	>200HB	MC7020	170 (120–220)	0.2 (0.1–0.35)
			MP7130	130 (80–180)	0.2 (0.1–0.35)
	Hardened Stainless Steel	<450HB	MC7020	110 (60–160)	0.2 (0.1–0.35)
			MP7130	90 (50–140)	0.2 (0.1–0.35)
S	Titanium Alloy	–	MP9130	45 (30–55)	0.1 (0.05–0.15)
	Heat Resistant Alloy	–	MP9130	35 (15–45)	0.1 (0.05–0.15)

Note 1) Actual cutting conditions are estimated to avoid chatter vibration with high rigidity of a machine or workpiece.

Make appropriate adjustments when chatter and/or insert chipping occurs during cutting.

Use with lowered conditions when there is a big overhang and/or when pocket-cutting.

Note 2) The setting level for feeding 1 blade is $a_p = 2.5\text{mm}$ with ARP5 axial cutting. With ARP6, use $a_p = 3\text{mm}$.

Use while matching the a_p fluctuation and correction value F of the respective table.

Ex. Feed for the recommended 1 blade when ARP5, SUS304, MP7130, $a_p=1$: $0.2\text{ mm/t.} \times 1.5$ (correction value F) = 0.3 mm/t.

Note 3) For grooving, use feed at the recommended 70% level. For ramping, drilling, and plunging, use 50% level.

Note 4) Internal coolant is recommended in titanium alloy and heat resistant alloy cutting.

When the coolant nozzle separately sold is used, it is more effective.

MAXIMUM CAPACITIES BY EACH CUTTING

Cutting Edge	Maximum hole diameter	Order Number	Install	Type	Recommendation (mm)		Ramping	Helical Drilling		Drilling Depth	Plunging
					ap	ae		RMPX(deg)	Smallest hole DH min.(mm)		
APMX (mm)	DCX (mm)										
5	25	ARP5PR2502AM1235	Screw-in	Standard	≤2.5	≤1.00DCX	1.8°	40	48	0.40	—
		ARP5PR2503AM1235	Screw-in	Fine Pitch	≤1.5	≤1.00DCX	1.8°	40	48	0.40	—
		ARP5PR2503SA25M	Shank	Standard	≤1.5	≤1.00DCX	1.8°	40	48	0.40	1.0
		ARP5PR2502SA25L	Shank	Long	≤1.5	≤1.00DCX	1.8°	40	48	0.40	1.0
	32	ARP5PR3203AM1640	Screw-in	Standard	≤2.5	≤1.00DCX	1.9°	54	62	0.65	1.0
		ARP5PR3204AM1640	Screw-in	Fine Pitch	≤2.5	≤1.00DCX	1.9°	54	62	0.65	1.0
		ARP5PR3204SA32M	Shank	Standard	≤2.5	≤1.00DCX	1.9°	54	62	0.65	1.0
		ARP5PR3203SA32L	Shank	Long	≤2.5	≤1.00DCX	1.9°	54	62	0.65	1.0
	40	ARP5P-040A05AR	Arbor	Fine Pitch	≤2.5	≤1.00DCX	2.8°	70	78	1.30	2.0
	50	ARP5P-050A06AR	Arbor	Fine Pitch	≤2.5	≤1.00DCX	2.9°	90	98	1.85	2.0
		ARP5P-050A07AR	Arbor	Extra Fine Pitch	≤1.5	≤1.00DCX	2.9°	90	98	1.85	2.0
	63	ARP5P-063A07AR	Arbor	Fine Pitch	≤2.5	≤0.75DCX	3.0°	116	124	2.50	2.5
		ARP5P-063A08AR	Arbor	Extra Fine Pitch	≤1.5	≤0.75DCX	3.0°	116	124	2.50	2.5
	6	32	ARP6PR3202AM1640	Screw-in	Standard	≤3.5	≤1.00DCX	2.0°	52	62	0.60
ARP6PR3203AM1640			Screw-in	Fine Pitch	≤3.5	≤1.00DCX	2.0°	52	62	0.60	1.0
ARP6PR3203SA32M			Shank	Standard	≤3.5	≤1.00DCX	2.0°	52	62	0.60	1.0
ARP6PR3202SA32L			Shank	Long	≤3.5	≤1.00DCX	2.0°	52	62	0.60	1.0
40		ARP6PR4003AM1640	Screw-in	Standard	≤3.5	≤1.00DCX	2.7°	68	78	1.15	2.5
		ARP6PR4004AM1640	Screw-in	Fine Pitch	≤3.5	≤1.00DCX	2.7°	68	78	1.15	2.5
		ARP6PR4004SA32M	Shank	Standard	≤3.5	≤1.00DCX	2.7°	68	78	1.15	2.5
		ARP6PR4003SA32L	Shank	Long	≤3.5	≤1.00DCX	2.7°	68	78	1.15	2.5
		ARP6P-040A04AR	Arbor	Fine Pitch	≤3.5	≤1.00DCX	2.7°	68	78	1.15	2.0
50		ARP6PR5005SA42M	Shank	Standard	≤3.5	≤1.00DCX	2.9°	88	98	1.70	2.5
		ARP6PR5004SA42L	Shank	Long	≤3.5	≤1.00DCX	2.9°	88	98	1.70	2.5
		ARP6P-050A05AR	Arbor	Fine Pitch	≤3.5	≤1.00DCX	2.9°	88	98	1.70	2.0
		ARP6P-050A06AR	Arbor	Extra Fine Pitch	≤2.5	≤1.00DCX	2.9°	88	98	1.70	2.0
63		ARP6P-063A06AR	Arbor	Fine Pitch	≤3.5	≤0.75DCX	3.1°	114	124	2.50	2.5
		ARP6P-063A07AR	Arbor	Extra Fine Pitch	≤2.5	≤0.75DCX	3.1°	114	124	2.50	2.5
80		ARP6PR08008CA	Arbor	Fine Pitch	≤3.5	≤0.60DCX	2.3°	148	158	2.50	2.5
		ARP6PR08009CA	Arbor	Extra Fine Pitch	≤2.5	≤0.60DCX	2.3°	148	158	2.50	2.5
100		ARP6PR10009DA	Arbor	Fine Pitch	≤3.5	≤0.50DCX	1.7°	188	198	2.50	2.5
	ARP6PR10011DA	Arbor	Extra Fine Pitch	≤2.5	≤0.50DCX	1.7°	188	198	2.50	2.5	

Note 1) Tool body durability may weaken when the amount of axial cutting exceeds ARP5 = 5 mm and ARP6 = 6 mm.

Note 2) When drilling, be careful of long scattered cutting chips.

Note 3) When cutting helical holes, do not exceed the largest APMX cutting depth per one rotation.

Note 4) Calculate using the following formula for centre tool tracks and ϕ dc when cutting helical holes : Centre tool tracks ϕ dc=desired hole diameter ϕ DH tool diameter ϕ DCX

Note 5) For preventing trouble with cutting chip biting, especially when grooving, ramping, helical cutting, and drilling, thoroughly eliminate cutting chips with an air blower or the like.

Note 6) Chip pockets are small for on small diameter cutters. Use with caution the ae and ap feed due to the possibility of cutting blockage.

Note 7) When cutting large ae with large diameter cutter, blockage from long chips is possible. Regulate ap and feed.

■ CORRECTION LEVEL F FEED AMOUNT FOR 1 BLADE, BASED ON AXIAL CUTTING AP FLUCTUATION

Holder	ap=0.5mm	ap=1mm	ap=1.5mm	ap=2mm	ap=2.5mm	ap=3mm	ap=3.5mm	ap=4mm	ap=5mm	ap=6mm
ARP5	2.3	1.5	1.2	1.1	1.0	0.9	0.8	0.8	0.8	—
ARP6	2.5	1.7	1.3	1.1	1.0	1.0	0.9	0.9	0.8	0.8

Note 1) Tool body durability may weaken, when the amount of axial cutting exceeds ARP5=5mm and ARP6=6mm.

K

ROTATING TOOLS

ARBORS

K

ROTATING TOOLS

STRAIGHT SHANK ARBOR

Type	Order Number	Stock	Dimensions (mm)						
			DCB	DCONMS	DCONWS	LF	LB	H	CRKS
			STEEL SHANK TYPE						
	SC16M08S100S	★	8.5	16	14.5	100	10	10	M8
	SC16M08S200L	★	8.5	16	14.5	200	10	10	M8
	SC20M10S120S	★	10.5	20	18.5	120	10	14	M10
	SC20M10S220L	★	10.5	20	18.5	220	10	14	M10
	SC25M12S125S	★	12.5	25	23.5	125	10	19	M12
	SC25M12S245L	★	12.5	25	23.5	245	10	19	M12
	SC32M16S140S	★	17	32	28.5	140	15	24	M16
	SC32M16S280L	★	17	32	28.5	280	15	24	M16
CARBIDE SHANK TYPE									
	SC16M08S100SW	★	8.5	16	14.5	100	10	10	M8
	SC16M08S200LW	★	8.5	16	14.5	200	10	10	M8
	SC20M10S120SW	★	10.5	20	18.5	120	10	14	M10
	SC20M10S220LW	★	10.5	20	18.5	220	10	14	M10
	SC25M12S125SW	★	12.5	25	23.5	125	10	19	M12
	SC25M12S245LW	★	12.5	25	23.5	245	10	19	M12
	SC32M16S140SW	★	17	32	28.5	140	15	24	M16
	SC32M16S280LW	★	17	32	28.5	280	15	24	M16

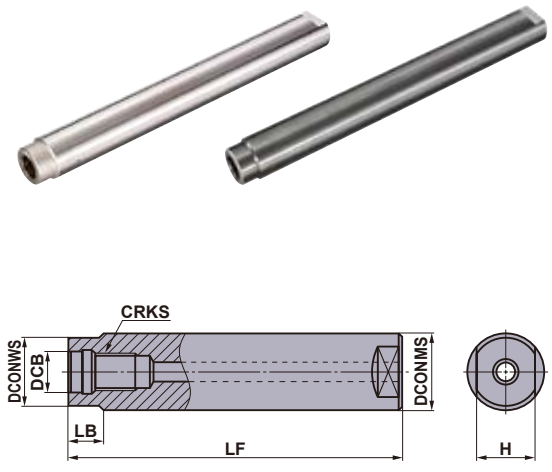

HOW TO INSTALL THE SCREW-IN HEAD

- ① Thoroughly clean the clamp section of the head and the arbor with an air blower or brush before installation.
- ② Tighten the head at the recommended torque and ensure that there is no gap between the head and arbor.

Screw Size	Recommended Torque (N · m)	Wrench Size (mm)
M8	23	10
M10	46	14
M12	80	19
M16	90	24



- Cutting tools become extremely hot during cutting. Never touch them with bare hands after operation as this may produce risk of injuries or burns.
- Do not handle the cutting tools with bare hands as this may cause injuries.

★ : Inventory maintained in Japan.

■ HSK63A SHANK ARBOR

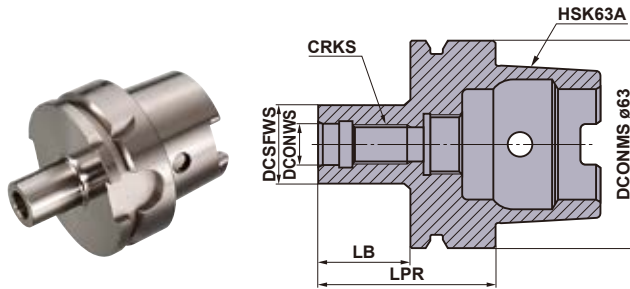

Order Number	Stock	Dimensions (mm)				
		DCONWS	DCSFWS	LPR	LB	CRKS
SC16M08S22-HSK63A	★	8.5	14.5	48	22	M8
SC20M10S24-HSK63A	★	10.5	18.5	50	24	M10
SC25M12S27-HSK63A	★	12.5	23.5	53	27	M12
SC32M16S28-HSK63A	★	17.0	28.5	54	28	M16

Note 1) The HSK63A shank type has a built-in coolant pipe for installation.

K

ROTATING TOOLS

ROTATING TOOLS

MAXIMUM ALLOWABLE REVOLUTION FOR CUTTER

K

ROTATING TOOLS

Diameter (mm)	WSX445		ASX445		WWX400		ASX400		FMAX	
	Max. Allowable Revolution (min ⁻¹)	Clamp Torque (N • m)	Max. Allowable Revolution (min ⁻¹)	Clamp Torque (N • m)	Max. Allowable Revolution (min ⁻¹)	Clamp Torque (N • m)	Max. Allowable Revolution (min ⁻¹)	Clamp Torque (N • m)	Max. Allowable Revolution (min ⁻¹)	Clamp Torque (N • m)
40	19000	3.5	—	—	—	—	—	—	30000	3.5
50	17000	3.5	18000	3.5	5000	5.0	18000	3.5	30000	3.5
63	15000	3.5	16000	3.5	14100	5.0	16000	3.5	27000	3.5
80	14000	3.5	14000	3.5	12200	5.0	14000	3.5	24500	3.5
100	12000	3.5	13000	3.5	10700	5.0	13000	3.5	22000	3.5
125	11000	3.5	12000	3.5	9500	5.0	12000	3.5	19600	3.5
160	9500	3.5	10000	3.5	8300	5.0	10000	3.5	—	—
200	8500	3.5	9000	3.5	7300	5.0	9000	3.5	—	—
250	—	—	8000	3.5	6400	5.0	8000	3.5	—	—
315	—	—	6500	3.5	—	—	—	—	—	—

Diameter (mm)	AHX440S		AHX475S		AHX640S		AHX640W		WJX14	
	Max. Allowable Revolution (min ⁻¹)	Clamp Torque (N • m)	Max. Allowable Revolution (min ⁻¹)	Clamp Torque (N • m)	Max. Allowable Revolution (min ⁻¹)	Clamp Torque (N • m)	Max. Allowable Revolution (min ⁻¹)	Clamp Torque (N • m)	Max. Allowable Revolution (min ⁻¹)	Clamp Torque (N • m)
40	21000	3.5	—	—	—	—	—	—	—	—
50	19800	3.5	18300	3.5	—	—	—	—	5000	5.0
52	—	—	—	—	—	—	—	—	5000	5.0
63	18300	3.5	17200	3.5	12000	5	—	—	18200	5.0
66	—	—	—	—	—	—	—	—	17700	5.0
80	16500	3.5	15700	3.5	10000	5	8900	6	15600	5.0
100	14600	3.5	14000	3.5	8700	5	7800	6	13500	5.0
125	12600	3.5	12200	3.5	7500	5	6600	6	11600	5.0
160	10200	3.5	9900	3.5	6100	5	5300	6	9900	5.0
200	—	—	—	—	5100	5	4100	6	—	—
250	—	—	—	—	—	—	2900	6	—	—
315	—	—	—	—	—	—	1700	6	—	—

Diameter (mm)	AXD4000		AXD7000		VPX200		VPX300		WJX09	
	Max. Allowable Revolution (min ⁻¹)	Clamp Torque (N • m)	Max. Allowable Revolution (min ⁻¹)	Clamp Torque (N • m)	Max. Allowable Revolution (min ⁻¹)	Clamp Torque (N • m)	Max. Allowable Revolution (min ⁻¹)	Clamp Torque (N • m)	Max. Allowable Revolution (min ⁻¹)	Clamp Torque (N • m)
16	—	—	—	—	37900	1.0	—	—	—	—
18	—	—	—	—	35300	1.0	—	—	—	—
20	15000	1.5	—	—	33200	1.0	—	—	—	—
22	—	—	—	—	31400	1.0	—	—	—	—
25	49000	1.5	—	—	29000	1.0	24100	3.0	33500	2.0
28	48500	1.5	—	—	27200	1.0	22500	3.0	30300	2.0
30	—	—	—	—	26000	1.0	21500	3.0	—	—
32	48000	1.5	41000	3.5	25100	1.0	20600	3.0	27300	2.0
35	45000	1.5	—	—	23800	1.0	19500	3.0	25500	2.0
40	41000	1.5	36000	3.5	22000	1.0	17900	3.0	23200	2.0
50	35000	1.5	30000	3.5	19200	1.0	15500	3.0	20000	2.0
52	—	—	—	—	—	—	—	—	19500	2.0
63	30000	1.5	25000	3.5	16700	1.0	13400	3.0	17300	2.0
66	—	—	—	—	—	—	—	—	16800	2.0
80	27000	1.5	23000	3.5	—	—	11500	3.0	—	—
100	23000	1.5	19000	3.5	—	—	—	—	—	—
125	20000	1.5	16000	3.5	—	—	—	—	—	—
160	—	—	—	—	—	—	—	—	—	—

Note 1) All values shown on this chart are based on the insert being properly seated in pocket and torqued to the recommended values.

LIST OF CUTTING EDGE DIAMETER TOLERANCES

Cutter Type	Cutting Edge Diameter Tolerance (mm)	Cutter Type	Cutting Edge Diameter Tolerance (mm)
AJX	-0.1 -0.4	CBMP	0 -0.3
APX3000 Arbor Type	-0.1 -0.4	PMF	0 -0.3
APX3000 Shank Type	-0.1 -0.2	PMR	0 -0.3
APX3000 Long Cutting Edge Type	-0.1 -0.3	SPX	-0.1 -0.3
APX4000 Arbor Type	-0.1 -0.4	SRF	0 -0.027
APX4000 Shank Type	-0.1 -0.2	SRM	-0.05 -0.15
APX4000 Long Cutting Edge Type	-0.1 -0.3	SUF	0 -0.02
AQX	-0.1 -0.3	TSMP	-0.1 -0.3
ARP Arbor Type	-0.1 -0.3	VFX5, VFX6 Shell Type	-0.1 -0.3
ARP Shank Type	-0.1 -0.2	VOX400 Arbor Type	-0.1 -0.4
ASX400	0 -0.3	VPX Arbor Type	-0.1 -0.3
AXD4000 Arbor Type	-0.1 -0.4	VPX Shank Type	-0.1 -0.2
AXD4000 Shank Type	-0.1 -0.2	VPX Long Cutting Edge Type	-0.1 -0.3
AXD7000 Arbor Type	-0.1 -0.4	WJX Arbor Type	-0.1 -0.3
AXD7000 Shank Type	-0.1 -0.2	WJX Shank Type	-0.1 -0.3
BRP	-0.1 -0.3	WWX400 Arbor Type	-0.1 -0.3
CBJP	0 -0.3	WWX400 Shank Type	-0.1 -0.3

Note 1) Cutting edge diameter tolerance when the gauge insert is set.

Note 2) When setting the insert available, the insert tolerance is added to the above tolerance.

(Tolerance when setting the insert for SRF.)

K

ROTATING TOOLS

HOW TO READ THE STANDARD OF ROTATING TOOL INSERTS

- How the section of milling inserts is organised
 - ① Organised according to cutter type.
 - ② Cutters are arranged in alphabetical order.
- How the standards for milling inserts are organised
 - ① Classified into milling inserts, wiper inserts and drilling inserts.
 - ② Arranged alphabetically by order number.

ROTATING TOOL INSERTS

CLASSIFICATION

Cutter Type	Order Number	Page	Cutter Type	Order Number	Page	Cutter Type	Order Number	Page
AHX440S	NNMU13050ZER-L	L030	AHX640S	NNMU20060ZEN-MK	L031	APX3000	AOMT123604PEER-H	L022
	WNEU13052ZEN-C-M	L049		NNMU20060ZEN-HK	L031		AOMT123616PEER-H	L022
AHX440S	NNMU13050ZEN-M	L030		WNEU2006ZENTC-WK	L050	APX4000	AOMT184804PEER-M	L022
AHX417S	NNMU13053ZEN-M	L030					AOMT184810PEER-M	L022
	NNMU13053ZEN-R	L030	AJX	JOMT06T182ZSR-JM	L024		AOMT184815PEER-M	L022
				JOMT09T320ZSR-JM	L024		AOMT184820PEER-M	L022
				JOMT12042ZSR-JM	L024			
				JOMT14052ZSR-JM	L024			
				JOMT18482ZSR-FT	L024			
AHX640S	WNEU2007ZENTC-M	L049		JOMW00T2182ZSR-FT	L024			
				JOMW00T3282ZSR-FT	L024			
				JOMW09T3282ZSR-FT	L024			
				JOMW12042ZSR-FT	L024			
				JOMW14052ZSR-FT	L024			
				JOMT06T182ZSR-JL	L024			
				JOMT08032ZSR-JL	L024			
	NNMU200708ZEN-MP	L031		JOMT12042ZSR-JL	L024			
	NNMU200708ZEN-M	L031		JOMT14052ZSR-JL	L024			
				JOMT18482ZSR-ST	L024			
				JOMT14052ZSR-ST	L024			
	NNMU200712ZER-MM	L031		JOMT14052ZSR-ST	L024			
				JOMT14052ZSR-ST	L024			
	NNMU200712ZER-L	L031						
	WNEU2007ZENTC-WP	L050						

GRADE APPLICATION RECOMMENDED FOR EACH WORK MATERIAL
cutting conditions suitable for each work materials are shown as a general guide to select grade.

●: Stable Cutting ●: General Cutting ✖: Unstable Cutting

ROTATING TOOL INSERTS

ROTATING INSERTS

Work Material	Shape	Order Number	Cutter Type	Coated	Data	Dimensions (mm)					Geometry	
						L	LE	W1	S	BS		RE
P Steel M Stainless Steel K Cast Iron N Non-ferrous Metal S Heat Resistant Steel M Hardened Material	L	WV400	ENGLU1409040PNER-L	G	●●●●●●●●●●●●●●●●	12	10	6.6	3.6	1.8	0.2	
		CK654	ENGLU1409040PNER-L	G	●●●●●●●●●●●●●●●●	12	10	6.6	3.6	1.2	0.8	
			ENGLU1409040PNER-L	G	●●●●●●●●●●●●●●●●	12	10	6.6	3.6	1.2	0.8	
			ENGLU1409040PNER-L	G	●●●●●●●●●●●●●●●●	12	10	6.6	3.6	1.2	0.8	
			ENGLU1409040PNER-L	G	●●●●●●●●●●●●●●●●	12	10	6.6	3.6	1.2	0.8	
			ENGLU1409040PNER-L	G	●●●●●●●●●●●●●●●●	12	10	6.6	3.6	1.2	0.8	
			ENGLU1409040PNER-L	G	●●●●●●●●●●●●●●●●	12	10	6.6	3.6	1.2	0.8	
			ENGLU1409040PNER-L	G	●●●●●●●●●●●●●●●●	12	10	6.6	3.6	1.2	0.8	
			ENGLU1409040PNER-L	G	●●●●●●●●●●●●●●●●	12	10	6.6	3.6	1.2	0.8	
			ENGLU1409040PNER-L	G	●●●●●●●●●●●●●●●●	12	10	6.6	3.6	1.2	0.8	
			ENGLU1409040PNER-L	G	●●●●●●●●●●●●●●●●	12	10	6.6	3.6	1.2	0.8	
			ENGLU1409040PNER-L	G	●●●●●●●●●●●●●●●●	12	10	6.6	3.6	1.2	0.8	
	APX3000	ADGT123602PEFR-GM	G	●●●●●●●●●●●●●●●●	12	10	6.6	3.6	1.8	0.2		
	CK133	ADGT123604PEFR-GM	G	●●●●●●●●●●●●●●●●	12	10	6.6	3.6	1.6	0.4		
	CK147	ADGT123608PEFR-GM	G	●●●●●●●●●●●●●●●●	12	10	6.6	3.6	1.2	0.8		
	APX3000	AOMT123604PEER-H	M	●●●●●●●●●●●●●●●●	12	10	6.6	3.6	1.8	0.4		
	CK133	AOMT123608PEER-H	M	●●●●●●●●●●●●●●●●	12	10	6.6	3.6	1.2	0.8		
	CK147	AOMT123616PEER-H	M	●●●●●●●●●●●●●●●●	12	10	6.6	3.6	0.4	1.6		
	APX3000	AOMT123602PEER-M	M	●●●●●●●●●●●●●●●●	12	10	6.6	3.6	1.8	0.2		
	CK133	AOMT123604PEER-M	M	●●●●●●●●●●●●●●●●	12	10	6.6	3.6	1.6	0.4		
	CK147	AOMT123616PEER-M	M	●●●●●●●●●●●●●●●●	12	10	6.6	3.6	1.2	0.8		
	APX3000	AOMT123616PEER-M	M	●●●●●●●●●●●●●●●●	12	10	6.6	3.6	1.8	1.0		
	CK147	AOMT123612PEER-M	M	●●●●●●●●●●●●●●●●	12	10	6.6	3.6	0.8	1.2		
	CK147	AOMT123612PEER-M	M	●●●●●●●●●●●●●●●●	12	10	6.6	3.6	0.8	1.2		
	APX4000	AOMT123624PEER-M	M	●●●●●●●●●●●●●●●●	12	10	6.6	3.6	0.4	2.0		
	CK149	AOMT123624PEER-M	M	●●●●●●●●●●●●●●●●	12	10	6.6	3.6	0.4	2.4		
	CK149	AOMT123630PEER-M	M	●●●●●●●●●●●●●●●●	12	10	6.6	3.6	0.4	3.0		
	APX4000	AOMT123632PEER-M	M	●●●●●●●●●●●●●●●●	12	10	6.6	3.6	0.4	3.2		
	CK149	AOMT184804PEER-H	M	●●●●●●●●●●●●●●●●	18	15	9	4.8	1.8	0.4		
	CK149	AOMT184808PEER-H	M	●●●●●●●●●●●●●●●●	18	15	9	4.8	1.4	0.8		
	APX4000	AOMT184816PEER-H	M	●●●●●●●●●●●●●●●●	18	15	9	4.8	0.4	1.6		
	CK149	AOMT184832PEER-H	M	●●●●●●●●●●●●●●●●	18	15	9	4.8	0.4	3.2		
	CK149	AOMT184840PEER-H	M	●●●●●●●●●●●●●●●●	18	15	9	4.8	0.4	4.0		
	APX4000	AOMT184850PEER-H	M	●●●●●●●●●●●●●●●●	18	15	9	4.8	0.4	5.0		
	CK149	AOMT184864PEER-H	M	●●●●●●●●●●●●●●●●	18	15	9	4.8	0.4	6.3		
	CK149	AOMT184864PEER-H	M	●●●●●●●●●●●●●●●●	18	15	9	4.8	0.4	6.3		
	APX4000	AOMT184804PEER-M	M	●●●●●●●●●●●●●●●●	18	15	9	4.8	1.8	0.4		
	CK149	AOMT184808PEER-M	M	●●●●●●●●●●●●●●●●	18	15	9	4.8	1.4	0.8		
	CK149	AOMT184810PEER-M	M	●●●●●●●●●●●●●●●●	18	15	9	4.8	1.0	1.0		
	APX4000	AOMT184812PEER-M	M	●●●●●●●●●●●●●●●●	18	15	9	4.8	0.8	1.2		
	CK149	AOMT184816PEER-M	M	●●●●●●●●●●●●●●●●	18	15	9	4.8	0.4	1.6		
	CK149	AOMT184820PEER-M	M	●●●●●●●●●●●●●●●●	18	15	9	4.8	0.4	2.0		

INSERT NUMBER

CUTTER TYPE

PHOTO OF INSERT

PAGE TO GO TO
indicates the reference pages for detailed standards of specific inserts.

INSERT GEOMETRY

INSERT DIMENSIONS

STOCK STATUS

LEGEND FOR STOCK STATUS MARK
is shown on the left hand page of each double-page spread.

● To Order : Please specify
① insert number and grade.

INDEXABLE MILLING TOOLS

INSERT STANDARDS







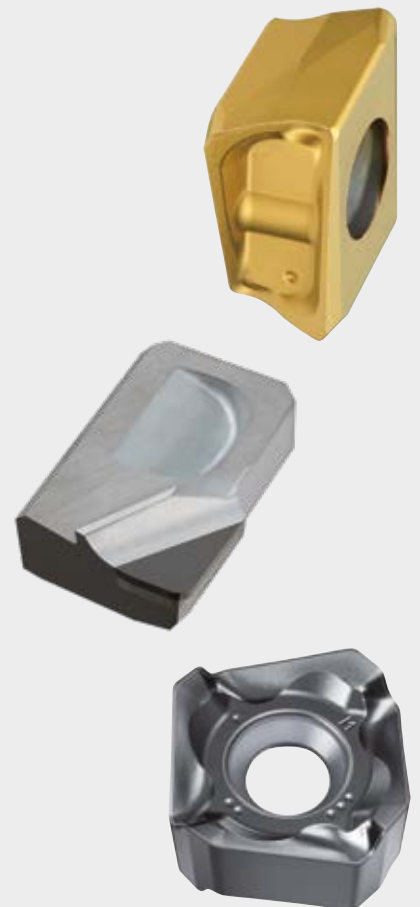

CBN & PCD INSERT STANDARDS







INSERT GRADES

IDENTIFICATION.....	L002
GRADES FOR MILLING	L004
MILLING APPLICATION RANGE	L005
COATED CARBIDE (CVD & PVD).....	L008
CERMET	L010
CEMENTED CARBIDE	L011
CBN (SINTERED CBN).....	L012
PCD (SINTERED DIAMOND)	L013
CLASSIFICATION	L014
STANDARD ROTATING TOOL INSERTS	
ROTATING INSERTS	L022
WIPER INSERTS	L049
CBN AND PCD.....	L051
CBN AND PCD WITH WIPER.....	L052







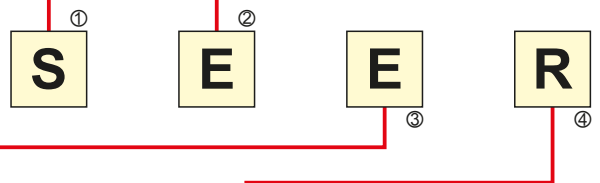

IDENTIFICATION

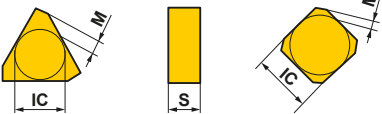
Symbol	Insert Shape	
6	Special Design	—
N	Heptagonal	
O	Octagonal	
S	Square	
T	Triangular	
C	Rhombic 80°	
M	Rhombic 86°	
A	Parallelogram 85°	
R	Round	
L	Rectangular	
J	Special Design	—
X	Special Design	—
W	Wiper	—
①Insert Shape		

Symbol	Normal Clearance AN	
C	7°	
D	15°	
E	20°	
F	25°	
G	30°	
N	0°	
P	11°	
O	Other	
X	Other	
②Normal Clearance		



③Tolerance Class			
			
Symbol	Tolerance of Nose Height M (mm)	Tolerance of Inscribed Circle IC (mm)	Tolerance of Thickness S (mm)
A	±0.005	±0.025	±0.025
C	±0.013	±0.025	±0.025
E	±0.025	±0.025	±0.025
G	±0.025	±0.025	±0.13
K*	±0.013	±0.05—±0.15	±0.025
M*	±0.08—±0.18	±0.05—±0.15	±0.13
N*	±0.08—±0.18	±0.05—±0.15	±0.025
The surface of insert with * mark is sintered.			

④Fixing and / or for Chipbreaker				
Symbol	Hole	Hole Configuration	Chipbreaker	Figure
W	With Hole	Cylindrical Hole + One Countersink (40°—60°)	No	
T	With Hole		Single Sided	
U	With Hole	Cylindrical Hole + Countersink (40°—60°)	Double Sided	
B	With Hole	Cylindrical Hole + One Countersink (70°—90°)	No	
N	Without Hole	—	No	
R	Without Hole	—	Single Sided	
X	—	—	—	Special Design

Symbol				Diameter of Inscribed Circle (mm)
	06	06	11	6.35
	08	07	13	7.94
	09	09	16	9.525
10				10.00
12				12.00
	12	12	22	12.70
	16	15	27	15.875
20				20.00

⑤ Insert Size

Symbol	Insert Thickness (mm)
03	3.18
T3	3.97
04	4.76

⑥ Insert Thickness

Symbol	Honing
F	 Sharp
E	 Round
T	 Chamfer
S	 Chamfer+Hone
X	 Round (small)
Z	 Chamfer (Strong Cutting Edge Type)

⑨ Cutting Edge Condition

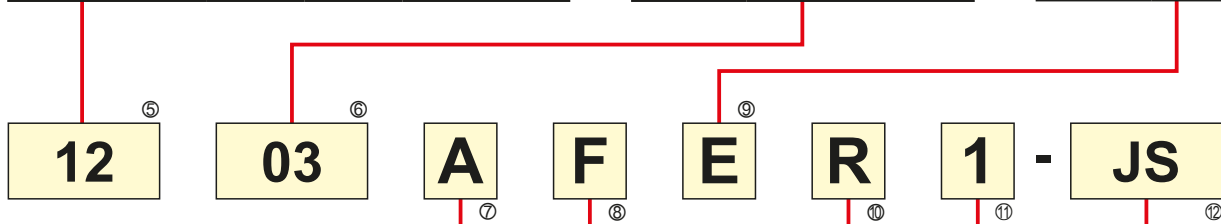

⑦ Cutting Edge Angle

Symbol	Cutting Edge Angle
A	45°
E	75°
P	90°
Z	Other Angle

⑧ Clearance of Wiper Insert

Symbol	Clearance Angle
D	15°
E	20°
F	25°
G	30°
N	0°
P	11°

⑩ Cutting Direction

L	Left
N	Neutral
R	Right

⑪ Width of Wiper Edge

Symbol	BS (mm)
1	1.4 (1.94 only for TEKN)
2	2.4

⑫ Chipbreaker

Symbol	Name
FT	FT Breaker
HS	HS Breaker
JH	JH Breaker
JM	JM Breaker
JS	JS Breaker
JL	JL Breaker
JP	JP Breaker
LS	LS Breaker
MM	MM Breaker
MS	MS Breaker
L	L Breaker
M	M Breaker
R	R Breaker

GRADES FOR MILLING

● INDEXABLE INSERT GRADES FOR MILLING

ROTATING INSERTS

ISO	Coated Carbide		Coated Cermet	Cermet	Cemented Carbide	CBN (Sintered CBN)	PCD (Sintered Diamond)
	CVD	PVD					
Steel	P	10					
		20	MC7020, FH7020, F7030	MP6120, VP15TF, MP6130	UP20M, VP20RT	VP25N	NX2525, MX3020
Stainless Steel	M	10					
		20	MC7020, F7030	VP15TF, MP7130, MP7030, UP20M, VP20RT	VP25N	NX2525, MX3020	
Cast Iron	K	10					
		20	MC5020	MP8010, VP15TF, VP20RT	VP25N	NX2525, MX3020, MX3030	
Non-Ferrous Metal	N	10					
		20		LC15TF			
Heat Resistant Alloy • Ti Alloy	S	10					
		20		MP9120, VP15TF, MP9130			
Hardened Materials	H	10					
		20		MP8010, VP15TF			
		30					
		40					
		10					
		20					
		30					
		40					
		10					
		20					
		30					
		40					

MILLING APPLICATION RANGE

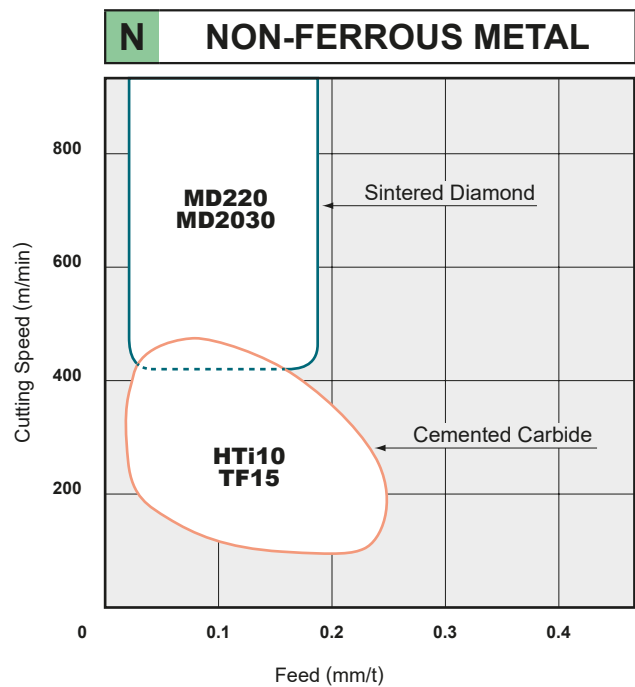
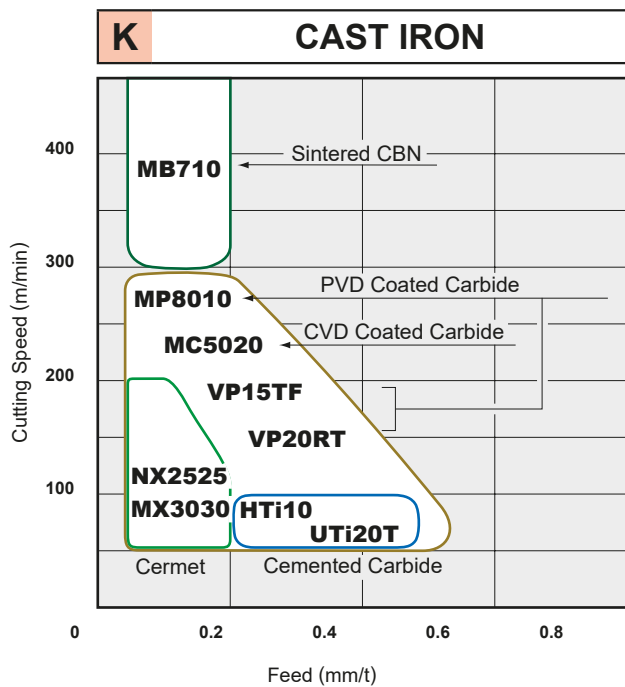
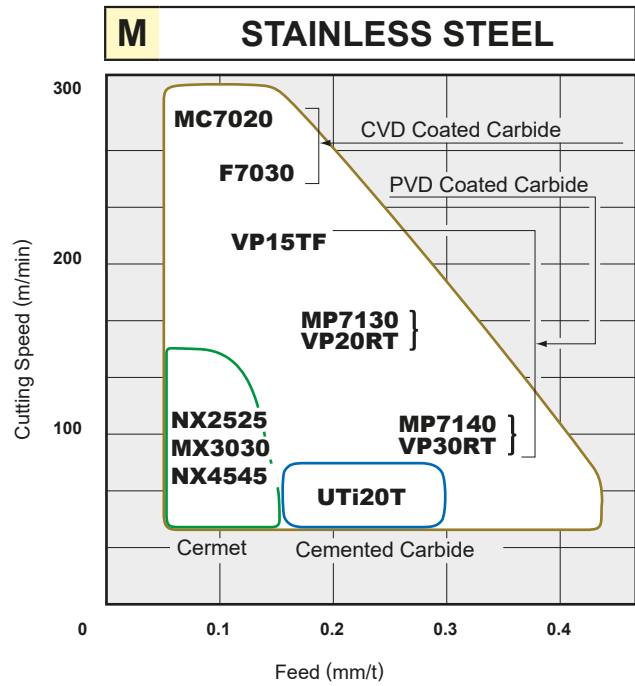
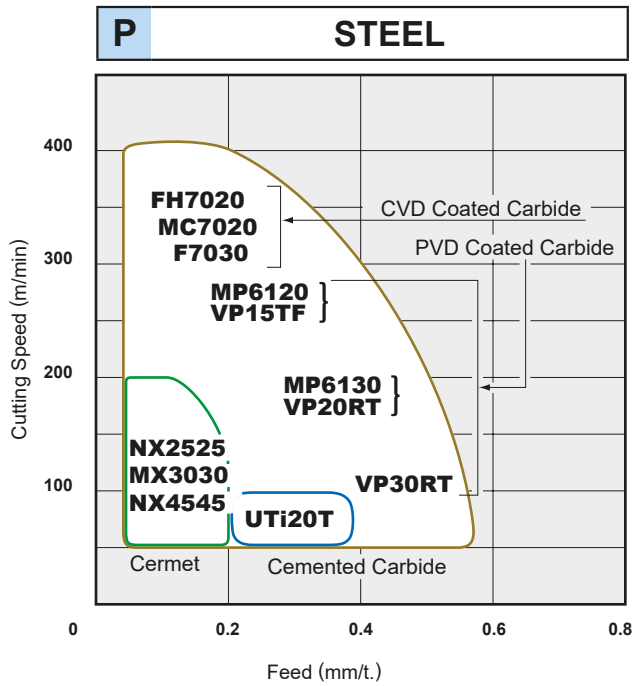

MILLING APPLICATION RANGE

● Recommendation of the insert grade based on cutting speed and conditions for each workpiece material.

ROTATING INSERTS

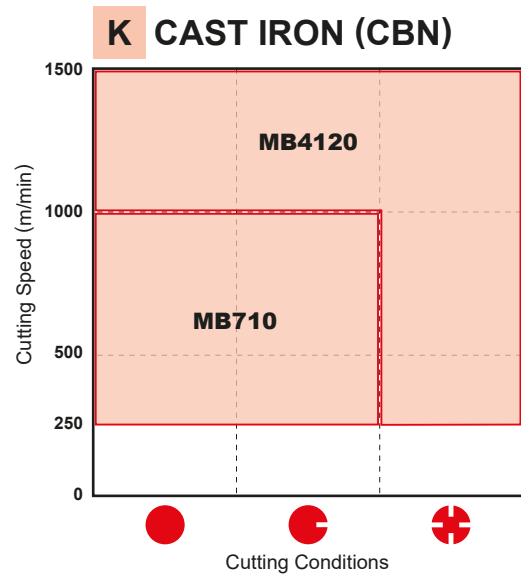
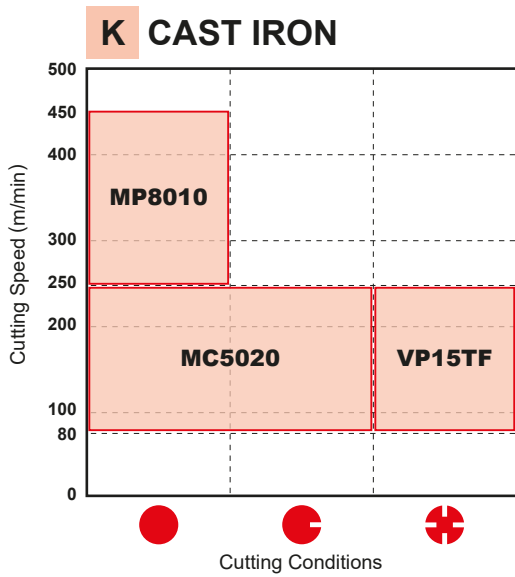
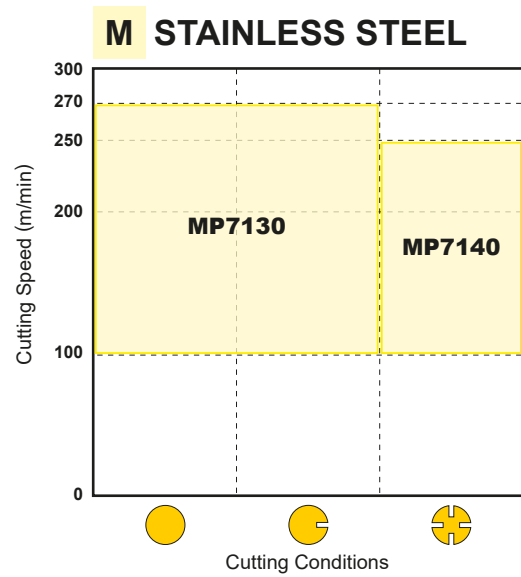
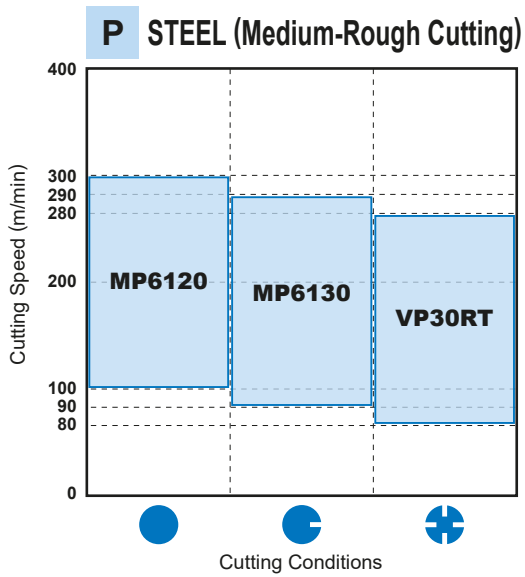

CUTTING CONDITIONS

- Stable Cutting**
 Plane Cutting
 Constant Depth of Cut
 Pre-Machined
 Securely Clamped Component Cutting
- General Cutting**
- Unstable Cutting**
 Heavy Interrupted Cutting
 Irregular Depth of Cut
 Low Clamping Rigidity Cutting

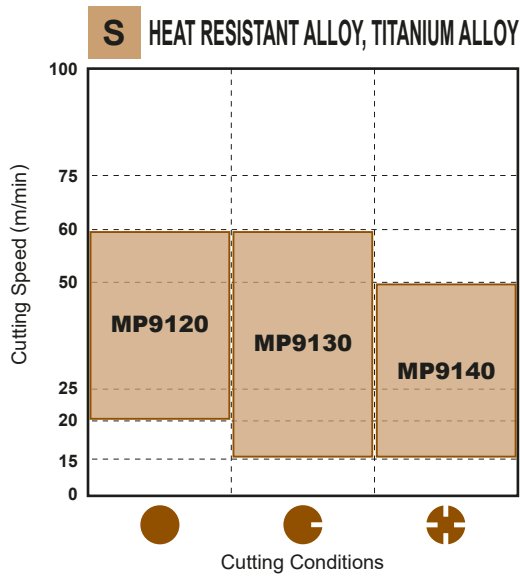
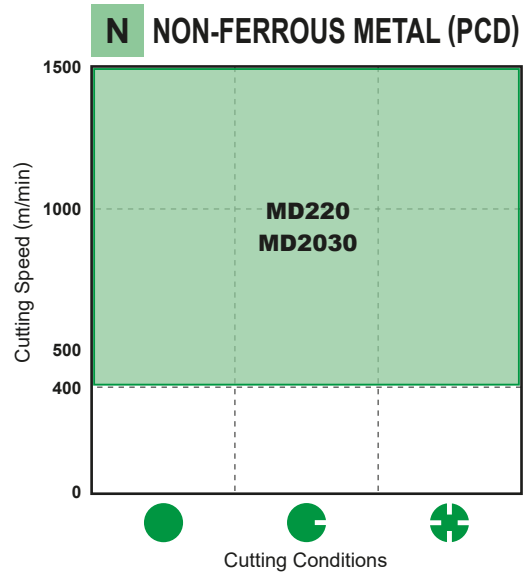
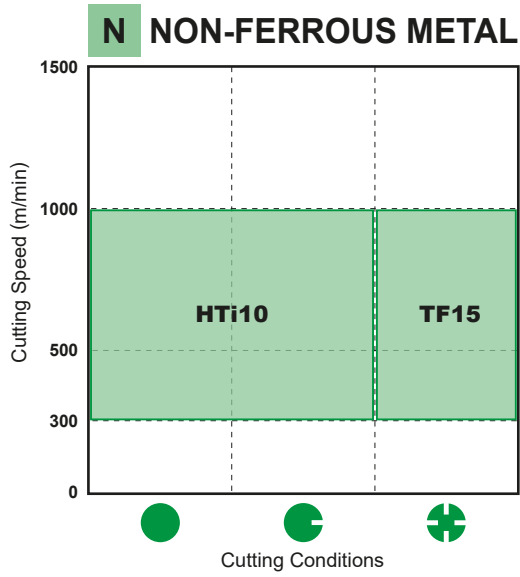

ROTATING INSERTS

COATED CARBIDE (CVD&PVD)

<CVD>

- Special tough fibrous structure improves wear and fracture resistance.
- It covers a wide application range and reduces the number of tools required.

<PVD>

- PVD coating prolongs tool life when compared to cemented carbide under the same cutting conditions.
- Coating of tools with sharp edges is possible without softening or changing the quality of the substrate.

SELECTION STANDARD

MILLING

ROTATING INSERTS

Work Material	Recommended Grade	ISO	Application Range
P Steel	F7030	P	
	MC7020		
	MP6120		
	MP6130		
	VP15TF		
M Stainless Steel	F7030	M	
	MC7020		
	MP7030		
	MP7130		
	MP7140		
	VP15TF		
K Cast Iron	MC5020	K	
	VP15TF		
N Aluminium Alloy	LC15TF	N	
S Heat Resistant Alloy Ti Alloy	MP9120	S	
	VP15TF		
	MP9130		
	NEW MP9140		
H Hardened Materials	MP8010	H	
	VP15TF		

■ GRADE CHARACTERISTICS

Grade	Substrate		Coating Layer	
	Hardness (HRA)	Composition	Thickness	
MC5020	91.0	TiCN-Al ₂ O ₃ -Ti Compound	Thick	
MC7020	88.8	TiCN-Al ₂ O ₃ Compound	Thick	
FH7020	89.0	TiCN-Al ₂ O ₃ -Ti Compound	Thick	
F7030	88.8	TiCN-Al ₂ O ₃ -TiN	Thin	
MP6120	91.5	(Al,Ti,Cr)N	Thin	
MP6130	90.5	(Al,Ti,Cr)N	Thin	
MP7030	90.5	(Al,Ti)N-Ti Compound	Thin	
MP7130	90.5	(Al,Ti)N-Ti Compound	Thin	
MP7140	88.8	(Al,Ti)N-Ti Compound	Thin	

Grade	Substrate		Coating Layer	
	Hardness (HRA)	Composition	Thickness	
MP8010	93.5	(Al,Ti,Si)N	Thin	
MP9120	91.5	(Al,Ti,Cr)N	Thin	
MP9130	90.5	(Al,Ti,Cr)N	Thin	
NEW MP9140	89.0	(Al,Ti)N	Thin	
VP15TF	91.5	(Al,Ti)N	Thin	
VP20RT	90.5	(Al,Ti)N	Thin	
VP30RT	88.8	(Al,Ti)N	Thin	
UP20M	90.5	Ti Compound	Thin	

Note 1) Internal hardness represent typical values shown as hardness.

For machining of steels and stainless steels

MC7020

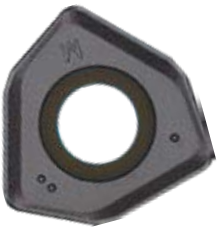

The micro-grain wear resistant Al₂O₃ and fibrous TiCN layers deliver excellent wear resistance during high speed cutting. Use of a specially developed cemented carbide that provides superior resistance to fracture and thermal cracking prevents the cutting edge from sudden breakage..

For machining of stainless steel

MP7030

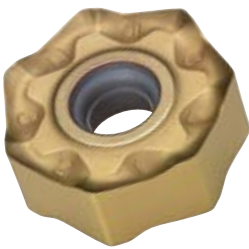

MP7030 has a multi-layer coating based on a newly developed Ti-compound. It provides superior wear and fracture resistance during stainless steel machining. A special tough cemented carbide substrate gives excellent performance when machining difficult-to-cut materials such as stainless steel.

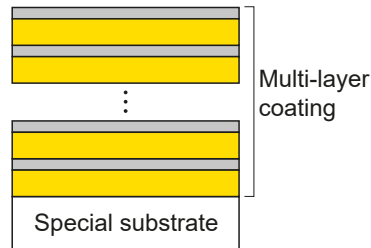

For Heat-resistant and Titanium Alloys

MP9130



An enhanced super fine cemented carbide substrate has increased toughness while maintaining hardness. The Al-Ti-Cr-N accumulating coating ensures optimum heat and wear resistance. The combination of these properties gives excellent fracture and welding resistance because of a low coefficient of friction when machining titanium alloy.

NEW

MP9140



The new technology Al-(Al, Ti)N coating provides stabilisation of the high hardness phase and succeeds in dramatically improving wear, crater and welding resistance.

CERMET

- NX2525 for high speed milling.
- NX4545, MX3030 for general milling.

SELECTION STANDARD MILLING

ROTATING INSERTS

Work Material	Recommended Grade	ISO	Application Range
Steel Stainless Steel	NX2525	P 10	
	MX3030 NX4545	M 20 30	
Cast Iron	NX2525	K 10	
	MX3030	K 20	

Note 1) In case of wet cutting, please use coated carbide VP15TF for steel cutting and coated carbide MC5020 for cast iron cutting.

GRADE CHARACTERISTICS

Grade	Hardness (HRA)
NX2525	92.2
MX3030	90.0
NX4545	90.0

Note 1) Internal hardness represent typical values shown as hardness.

CEMENTED CARBIDE

● The grades available are UTi20T for steel and cast iron, and HTi10 for cast iron, non-ferrous metal and non-metal.

SELECTION STANDARD MILLING

Work Material	Recommended Grade	ISO	Application Range
P Steel	UTi20T	10	
		20	
		30	UTi20T
M Stainless Steel	UTi20T	10	
		20	
		30	UTi20T
K Cast Iron	HTi05T	10	HTi05T
	HTi10	20	HTi10
	UTi20T	30	UTi20T
N Non-Ferrous Metal	HTi10	10	HTi10
	TF15	20	
		30	TF15

ROTATING INSERTS

MAIN COMPONENT AND APPLICATION

ISO	Main Component	Characteristics	Work Material
P M	WC-TiC-TaC-Co	Heat / Deformation resistance.	Carbon steel, Alloy steel, Stainless steel and Cast iron
K N	WC-Co	High rigidity and wear resistance.	Cast iron, Non-Ferrous metals and Non-metal

GRADE CHARACTERISTICS

ISO	Grade	Hardness (HRA)
P M	UTi20T	90.5
K N	HTi05T	92.5
	HTi10	92.0
N	TF15	91.5

Note 1) Internal hardness represent typical values shown as hardness.

CBN (SINTERED CBN)

● MB710 and MB730 for cast iron finishing.

L

SELECTION STANDARD / RECOMMENDED CUTTING CONDITIONS

FINISHING

Work Material		Structure	Cutting Speed (m/min)					Feed (mm/t)	Depth of Cut (mm)	Coolant
			250	500	750	1000	1250			
Grey Cast Iron	DIN GG25	Ferritic + Pearlitic	MB710					-0.3	-0.5	Dry
	DIN GG30	Pearlitic								

FEATURES AND BASE

Grade	Application	Features	Main Component	Coating Layer
MB710	For General Cutting	General purpose grade with well balanced wear and fracture resistance.	CBN TiC Al ₂ O ₃	-

ROTATING INSERTS

PCD (SINTERED DIAMOND)

- Suitable for cutting non-ferrous metals such as aluminium alloy.
- Suitable for extremely high speed finishing.

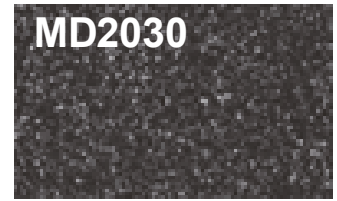
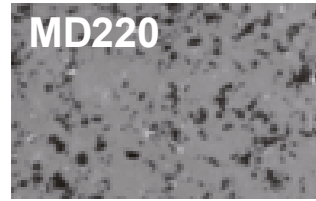

GRADE FEATURES

Grade	Features
MD220	Excellent in the balance between wear resistance and fracture resistance. For a wide range of tooling applications.
MD2030	Improved fracture resistance when used in unstable applications. The stability of the cutting edge can meet a wide variety of work material and cutting conditions.

RECOMMENDED CUTTING CONDITIONS

Work Material	Cutting Speed (m/min)	Grade	Feed per Tooth (mm/t)	Depth of Cut (mm)
Aluminium Alloy (Si ≤12%)	2000—3000	MD2030	—0.2	—3.0
Aluminium Alloy (Si ≥13%)	400—800	MD220		

CUTTING PERFORMANCE

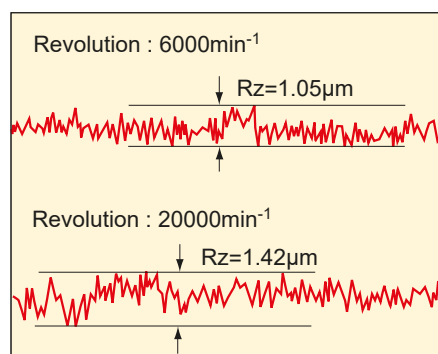
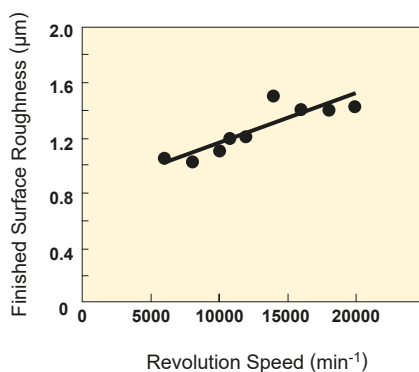

<Cutting Conditions>









Workpiece : Aluminium Alloy
 Insert : NP-GDCW1240PDFR2
 Grade : MD220
 Tool : V10000R0406D
 Feed : 0.2mm/t
 Depth of Cut : 0.5mm
 Width of Cut : 80mm
 Dry Cutting

CLASSIFICATION

ROTATING INSERTS







Cutter Type	Order Number	Page
	NNMU130508ZER-L	L030
	WNEU1305ZEN4C-M	
	NNMU130508ZEN-M	L030
	NNMU130532ZEN-M	
	NNMU130532ZEN-R	L030
	WNEU2007ZEN7C-M	L049
	NNMU200708ZEN-MP	L031
	NNMU200708ZEN-M	
	NNMU200712ZER-MM	L031
	NNMU200712ZER-L	L031
	WNEU2007ZEN7C-WP	L050

Cutter Type	Order Number	Page
	AHX640S	L031
	AHX640W	
	NNMU200608ZEN-HK	L031
	WNEU2006ZEN7C-WK	L050
	JOMT06T215ZZSR-JM	L024
	JOMT080320ZZSR-JM	
	JDMT09T320ZDSR-JM	
	JDMT120420ZDSR-JM	
	JOMW06T215ZZSR-FT	L024
	JOMW080320ZZSR-FT	
	JDMW09T320ZDSR-FT	
	JDMW120420ZDSR-FT	
	JDMW140520ZDSR-FT	L024
	JOMT06T216ZZER-JL	
	JOMT080322ZZER-JL	
	JDMT09T323ZDER-JL	
	JDMT120423ZDER-JL	L024
	JDMT140523ZDER-JL	
	JDMT120420ZDSR-ST	
	JDMT140520ZDSR-ST	
	AOGT123602PEFR-GM	L022
	AOGT123604PEFR-GM	
	AOGT123608PEFR-GM	
	AOMT123602PEER-M	L022
	AOMT123604PEER-M	
	AOMT123608PEER-M	
	AOMT123610PEER-M	
	AOMT123612PEER-M	
	AOMT123616PEER-M	
	AOMT123620PEER-M	
	AOMT123624PEER-M	
	AOMT123630PEER-M	
	AOMT123632PEER-M	

Cutter Type	Order Number	Page
	AOMT123604PEER-H	L022
	AOMT123608PEER-H	
	AOMT123616PEER-H	
	AOMT184804PEER-M	L022
	AOMT184808PEER-M	
	AOMT184810PEER-M	
	AOMT184812PEER-M	
	AOMT184816PEER-M	
	AOMT184820PEER-M	L022
	AOMT184804PEER-H	
	AOMT184808PEER-H	
	AOMT184816PEER-H	
	AOMT184832PEER-H	L022
	AOMT184840PEER-H	
	AOMT184850PEER-H	
	AOMT184864PEER-H	
	QOGT0830R-G1	L032
	QOGT1035R-G1	
	QOGT1342R-G1	
	QOGT1651R-G1	
	QOGT1856R-G1	
	QOGT2062R-G1	
	QOGT2576R-G1	L032
	QOMT0830R-M2	
	QOMT1035R-M2	
	QOMT1342R-M2	
	QOMT1651R-M2	
	QOMT1856R-M2	L032
	QOMT2062R-M2	
	QOMT2576R-M2	
	RPHT1040M0E4-L	L034
	RPHT1248M0E4-L	
	RPHT1040M0E4-M	
	RPHT1248M0E4-M	
	RPHT1040M0E4-R	
	RPHT1248M0E4-R	























Cutter Type	Order Number	Page
	RPMT1040M0E4-L	L034
	NEW RPMT1040M0E8-L1	
	NEW RPMT1040M0E4-L2	
	RPMT1248M0E4-L	
	NEW RPMT1248M0E8-L1	
	NEW RPMT1248M0E4-L2	
	RPMT1040M0E4-M	
	NEW RPMT1040M0E8-M1	
	NEW RPMT1040M0E4-M2	
	RPMT1248M0E4-M	
	NEW RPMT1248M0E8-M1	
	NEW RPMT1248M0E4-M2	
	RPMT1040M0E4-R	
	NEW RPMT1040M0E8-R1	
RPMT1248M0E4-R		
NEW RPMT1248M0E8-R1		
	JPGX1404080PPER-JM	L025
	JPGX1404120PPER-JM	
	JPGX1404160PPER-JM	
	JPGX1404240PPER-JM	
	JPGX1404320PPER-JM	
	JPGX1404400PPER-JM	
	JPGX1404500PPER-JM	
JPGX1404635PPER-JM		
	SPGX1204100PPER-JM	L040
	SOGT12T308PEFR-JP	L038
	SOET12T308PEER-JL	L038
	SOMT12T308PEER-JM	L038
	SOMT12T308PEEL-JM	

Cutter Type	Order Number	Page
	SOMT12T308PEER-JH	L038
	SOMT12T320PEER-FT	L038
	WOEW12T308PEER8C	L050
	WOEW12T308PETR8C	
	SEGT13T3AGFN-JP	L036
	SEET13T3AGEN-JL	L036
	SEMT13T3AGSN-JM	L037
	SEMT13T3AGSN-JH	L037
	SEMT13T3AGSN-FT	L036
	WEEW13T3AGFR3C	L052
	WEEW13T3AGTR3C	
	WEEW13T3AGER8C	L049
	WEEW13T3AGTR8C	









Cutter Type	Order Number	Page
	XDGX175004PDFR-GL	L046
	XDGX175008PDFR-GL	
	XDGX175012PDFR-GL	
	XDGX175016PDFR-GL	
	XDGX175020PDFR-GL	
	XDGX175024PDFR-GL	
	XDGX175030PDFR-GL	
	XDGX175032PDFR-GL	
	XDGX175040PDFR-GL	
	XDGX175050PDFR-GL	
	XDGX175004PDER-GM	L046
	XDGX175008PDER-GM	
	XDGX175012PDER-GM	
	XDGX175016PDER-GM	
	XDGX175020PDER-GM	
	XDGX175024PDER-GM	
	XDGX175030PDER-GM	L046
	XDGX175032PDER-GM	
	XDGX175040PDER-GM	
	XDGX175050PDER-GM	
	XDGX175004PDFR-GM	
	XDGX175008PDFR-GM	
	XDGX175012PDFR-GM	L046
	XDGX175016PDFR-GM	
	XDGX175020PDFR-GM	
	XDGX175024PDFR-GM	
	XDGX175030PDFR-GM	
	XDGX175032PDFR-GM	
	XDGX227008PDFR-GL	L046
	XDGX227016PDFR-GL	
	XDGX227020PDFR-GL	
	XDGX227030PDFR-GL	
	XDGX227032PDFR-GL	
	AEMW150304ER	L023
	AEMW150308ER	
	AEMW19T304ER	
	AEMW19T308ER	
	APGT1135PDFR-G2	L023







CLASSIFICATION

ROTATING INSERTS

Cutter Type	Order Number	Page	Cutter Type	Order Number	Page	Cutter Type	Order Number	Page
BAP300 SRM2 	APMT1135PDER-M0	L023	BRP 	RPMT08T2M0E-JS	L034	DCCC 	CCMX09T308EN-B	L024
	APMT1135PDER-M1			RPMT10T3M0E-JS			ZCMX083508ER-A	
	APMT1135PDER-M2			RPMT1204M0E-JS			ZCMX09T308ER-A	
	APMT1135PDER-H1	L023				RPMW08T2M0E	L034	
	APMT1135PDER-H2		RPMW08T2M0T					
	APMT1135PDER-H3		RPMW10T3M0E					
	APMT1135PDER-H4		RPMW10T3M0T					
	APMT1135PDER-H6		RPMW1204M0E					
			RPMW1204M0T					
BAP400 	APGT1604PDFR-G2	L023	BSP 	SPMB1204APT	L040		SPEN1203EEER1	L039
BAP400 SRM2 	APMT1604PDER-M2	L023	CBJP TAB 	JPMT060204-E	L025		SPER1203EEER-JS	
	APMT1604PDER-H1	L023	CBMP ECMP TAB 	MPMT070308	L030		SPEN1203EETR1	L051
	APMT1604PDER-H2			MPMT090308				
	APMT1604PDER-H4			MPMT120408				
	APMT1604PDER-H6							
BF407 	SFAN1203ZFFR2	L037	CESP CFSP CGSP 	SPMW090304	L040		WPC42EEER10C	L050
	SFAN1203ZFFL2			SPMW090308				
	SFCN1203ZFFR2			SPMW120304				
BN425 DN 	SNC43B2S	L037	DCCC 	SPMW120308	L024		SPCA53Z	L039
	SNMF43B2G	L037		CCMX083508EN-A	L024		SPCG53Z	L039
							CCMX09T308EN-A	

Cutter Type	Order Number	Page
FMAX 	GOER1404PXFR2	L051
	GOER1408PXFR2	
NEW 	GOER1408PXFR2-8	L051
	GOER1401ZXFR2	L051
NEW 	NP-GOEN1404PXSR05	L051
	NP-GOEN1408PXSR05	
FP490 	SPEN424A	L039
LSE445 SE445 	SEEN1203AFEN1	L035
	SEEN1203AFTN1	
	SEEN1203AFTN3	L035
	SEER1203AFEN-JS	L035
NSE300 SE300 	TECN1603PEFR1W	L044
	TECN1603PEER1W	
	TECN1603PETR1W	L044

Cutter Type	Order Number	Page
NSE300 SE300 	TECN1603PEFR1	L051
		L051
	TEEN1603PEFR1	L044
	TEEN1603PEER1	
	TEEN1603PETR1	
	TEEN1603PESR1	
	TEEN1603PEZR1	
NSE300 	TEER1603PEER-JS	L044
		L044
NSE400 	TEER2204PEER-JS	L044
		L044
NSE400 SE400 	TECN2204PEFR1	L044
	TECN2204PEER1	
	TECN2204PETR1	
	TEEN2204PEFR1	
	TEEN2204PEER1	
	TEEN2204PETR1	
	TEEN2204PESR1	
OCTACUT 	OEMX12T3ETR1	L031
	OEMX12T3ESR1	
	OEMX1705ETR1	
	OEMX1705ESR1	
	OEMX12T3EER1-JS	L031
	OEMX1705EER1-JS	
	OEMX1705ETR1-JS	
	REMX1705SN	L033
		L033



Cutter Type	Order Number	Page
OCTACUT 	REMX12T3EN-JS	L033
	REMX1705EN-JS	
PMF 	TPEW1303ZPER2	L045
		L045
	TPEW1303ZPTR2	L052
		L052
RRD 	RDHX0501M0E	L032
	RDHX0501M0S	
	RDHX07T1M0E	
	RDHX07T1M0S	
	RDHX0702M0E	
	RDHX0702M0S	
	RDHX1003M0E	
RDHX1003M0S		
	RDHX12T3M0E	L032
	RDHX12T3M0S	
	RDHX1604M0E	
	RDHX1604M0S	
	RDMX07T1M0E	L033
	RDMX07T1M0T	
	RDMX0702M0E	
	RDMX0702M0T	
	RDMX1003M0E	
	RDMX1003M0S	
	RDMX1003M0T	
	RDMX12T3M0E	
	RDMX12T3M0S	
	RDMX12T3M0T	
	RDMX1604M0E	
RDMX1604M0S		
RDMX1604M0T		

ROTATING INSERTS



CLASSIFICATION

ROTATING INSERTS

Cutter Type	Order Number	Page	Cutter Type	Order Number	Page	Cutter Type	Order Number	Page
	RDZX0501M0E	L033		SEEN1504AFEN1	L035		SRBT10	L042
	RDZX07T1M0E			SEEN1504AFTN1			SRBT12	
	RDZX0702M0E			SEEN1504AFTN3			SRBT16	
	RDZX1003M0E			SEEN1504AFSN1			SRBT20	
	RDZX1003M0S						SRBT25	
	RDZX12T3M0E		SEER1504AFEN-JS	SRBT30				
	RDZX12T3M0S			SRBT32				
	RDZX1604M0E							
RDZX1604M0S								
	CPMT1205ZPEN-M2	L024		WEC53AFTR5C	L049		SRFT10	L042
	CPMT1205ZPEN-M3						SRFT12	
	CPMT1906ZPEN-M2			SRFT16				
	CPMT1906ZPEN-M3			SRFT20				
	SEEN1203EFFR1	L035		RGEN2004M0EN	L033		SRG16C	L042
	SEEN1203EFER1			RGEN2004M0SN			SRG20C	
	SEEN1203EFTR1						SRG25C	
	SEEN1203EFTR3						SRG30C	
	SEEN1203EFSR1						SRG32C	
	SEER1203EFER-JS	L036		JPMX140412-JM	L025		SRG16E	L042
				JPMX190412-JM			SRG20E	
	JPMX140412-WH	L025		JPMX190412-WH	L025		SRG25E	L042
	SRM16C-M	L043		SRM20C-M	L043		SRG30E-M	L043
	SRM25C-M			SRM30C-M			SRM32E-M	
	SECN1203EFFR1	L051		MPMX120412-JM	L030		SRM16E-M	L043
	WEC42EFTR5C	L049		MPMX120412-WH	L030		SRM25E-M	L043
	SRG40C	L042		SPMX120408-JM	L041		SRG50C	L042
	SRG50C							
	SECN1504EFTR1	L036		SPMX120408-WH	L041		SRG50E	L042
	SEEN1504EFER1							
	SEEN1504EFTR1	L036		APMT1135PDER-M2	L023		APMT1604PDER-M2	L023
	SEEN1504EFSR1							
	WEC53EFTR5C	L049						

Cutter Type	Order Number	Page
SRM2 $\phi 40$ $\phi 50$ 	APMT1135PDER-H2	L023
	APMT1604PDER-H2	
SUF 	SUFT10R05	L043
	SUFT10R10	
	SUFT10R20	
	SUFT12R05	
	SUFT12R10	
	SUFT12R20	
	SUFT12R30	
	SUFT16R05	
	SUFT16R10	
	SUFT16R15	
	SUFT16R20	
	SUFT16R30	
	SUFT20R05	
	SUFT20R10	
	SUFT20R15	
	SUFT20R20	
	SUFT20R30	
	SUFT25R05	
	SUFT25R10	
	SUFT25R20	
	SUFT25R30	
	SUFT30R05	
	SUFT30R10	
	SUFT30R20	
SUFT30R30		
SUFT32R05		
SUFT32R10		
SUFT32R20		

Cutter Type	Order Number	Page
DCV3 Side Cutter 	LNGU090604PNER-M	L026
	LNGU090604PNEL-M	
	LNGU090608PNER-M	
	LNGU090608PNEL-M	
	LNGU090612PNER-M	
	LNGU090612PNEL-M	
	LNGU090616PNER-M	
	LNGU090616PNEL-M	
	LNGU090620PNER-M	
	LNGU090620PNEL-M	
	LNGU090624PNER-M	
	LNGU090624PNEL-M	
	LNGU090630PNER-M	
	LNGU090630PNEL-M	
LNGU090640PNER-M		
LNGU090640PNEL-M		
DCV4 Side Cutter 	LNGU130804PNER-M	L026
	LNGU130804PNEL-M	
	LNGU130808PNER-M	
	LNGU130808PNEL-M	
	LNGU130820PNER-M	
	LNGU130820PNEL-M	
	LNGU130830PNER-M	
	LNGU130830PNEL-M	
	LNGU130840PNER-M	
	LNGU130840PNEL-M	
NEW 	LNGU130804PNER-R	L026
	LNGU130804PNEL-R	
	LNGU130808PNER-R	
	LNGU130808PNEL-R	
	LNGU130812PNER-R	
	LNGU130812PNEL-R	
	LNGU130816PNER-R	
	LNGU130816PNEL-R	
	LNGU130820PNER-R	
	LNGU130820PNEL-R	
	LNGU130824PNER-R	
	LNGU130824PNEL-R	
	LNGU130830PNER-R	
	LNGU130830PNEL-R	
LNGU130840PNER-R		
LNGU130840PNEL-R		
LNGU130850PNER-R		
LNGU130850PNEL-R		









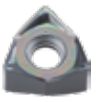
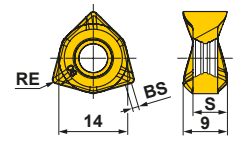

Cutter Type	Order Number	Page
DCV4 Side Cutter 	LNGU171004PNER-R	L027
	LNGU171004PNEL-R	
	LNGU171008PNER-R	
	LNGU171008PNEL-R	
	LNGU171012PNER-R	
	LNGU171012PNEL-R	
	LNGU171016PNER-R	
	LNGU171016PNEL-R	
	LNGU171020PNER-R	
	LNGU171020PNEL-R	
	LNGU171024PNER-R	
	LNGU171024PNEL-R	
	LNGU171030PNER-R	
	LNGU171030PNEL-R	
	LNGU171040PNER-R	
	LNGU171040PNEL-R	
LNGU171050PNER-R		
LNGU171050PNEL-R		
LNGU171060PNER-R		
LNGU171060PNEL-R		
LNGU171070PNER-R		
LNGU171070PNEL-R		
VPX200 	LOGU0904020PNER-L	L028
	LOGU0904040PNER-L	
	LOGU0904080PNER-L	
	LOGU0904100PNER-L	
	LOGU0904120PNER-L	
	LOGU0904160PNER-L	
	LOGU0904020PNFR-L	
	LOGU0904040PNFR-L	
	LOGU0904080PNFR-L	
	LOGU0904100PNFR-L	
LOGU0904160PNFR-L		
NEW 	LOGU0904020PNER-M	L028
	LOGU0904040PNER-M	
	LOGU0904080PNER-M	
	LOGU0904100PNER-M	
	LOGU0904120PNER-M	
	LOGU0904160PNER-M	
	LOGU0904020PNFR-M	
	LOGU0904040PNFR-M	
	LOGU0904080PNFR-M	
	LOGU0904100PNFR-M	
LOGU0904120PNFR-M		
LOGU0904160PNFR-M		

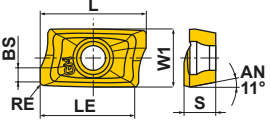
ROTATING INSERTS

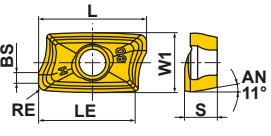
Cutter Type	Order Number	Page
Corner Angle 45° 15° Positive 	SDEN1203AEN	L035
Corner Angle 45° 20° Positive 	SEER1204AFEN-JS	L035
	SEEW1204AFTN	L036
	SEMN1204AZTN	L036
Negative 	SNEN1204EN SNEN1504EN	L037
	SNMN120408 SNMN120412	L038
11° Positive 	SPGN120304	L040
	SPGN120308	
	SPGN120312	
	SPGN150404	
	SPGN150408	
	SPMN120304	
	SPMN120304T	
	SPMN120308	
	SPMN120312	
	SPMN120408	
	SPMN120412	
	SPMN150408 SPMN150412	

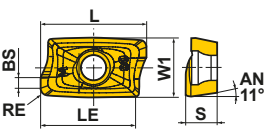

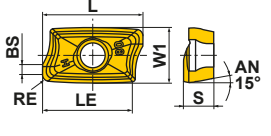

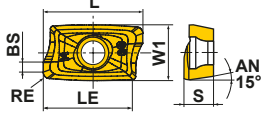





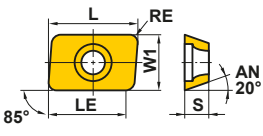

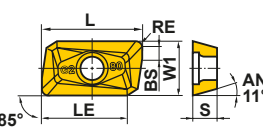
Cutter Type	Order Number	Page
11° Positive 	TPMN160304	L045
	TPMN160308	
	TPMN160312	
	TPMN220404	
	TPMN220408	
	TPMN220408T TPMN220412	

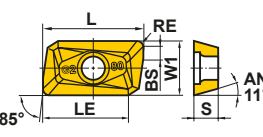
ROTATING INSERTS

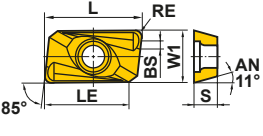
Work Material	P	Steel	●		●		●		●		●		Cutting Conditions (Guide): ●: Stable Cutting ●: General Cutting ✖: Unstable Cutting	Honing: E: Round F: Sharp							
	M	Stainless Steel	●		●		●		●		●										
	K	Cast Iron	●		●		●		●		●										
N	Non-ferrous Metal	●		●		●		●		●											
S	Heat-resistant Alloy, Titanium Alloy	●		●		●		●		●											
H	Hardened Materials	●		●		●		●		●											
Shape	Order Number	Class	Honing	Coated								Carbide	Dimensions (mm)						Geometry		
				MC5020	MP6120	MP6130	MP7130	MP9120	MP9130	VP15TF	VP20RT	TF15	L	LE	W1	S	BS	RE			
WWX400 ↻K056 NEW 	6NGU1409040PNER-L	G	E	★	★	★	●	●	●	●	●	●	●	●	—	—	—	7	1.7	0.4	
	6NGU1409080PNER-L	G	E	★	●	●	●	●	●	●	●	●	●	●	—	—	—	7	1.3	0.8	
	6NGU1409040PNFR-L	G	F											●	—	—	—	7	1.7	0.4	
	6NGU1409080PNFR-L	G	F											●	—	—	—	7	1.3	0.8	
	6NMU1409040PNER-M	M	E	●	●	●	●	●	●	●	●	●	●	●	—	—	—	7	1.7	0.4	
	6NMU1409080PNER-M	M	E	●	●	●	●	●	●	●	●	●	●	●	—	—	—	7	1.3	0.8	
	6NMU1409080PNER-R	M	E	●	●	●	●	●	●	●	●	●	●	●	—	—	—	7	1.3	0.8	
APX3000 ↻K133 APX3000 Long Cutting Edge ↻K147 	AOGT123602PEFR-GM	G	F											●	12	10	6.6	3.6	1.8	0.2	
	AOGT123604PEFR-GM	G	F											●	12	10	6.6	3.6	1.6	0.4	
	AOGT123608PEFR-GM	G	F											●	12	10	6.6	3.6	1.2	0.8	
APX3000 ↻K133 APX3000 Long Cutting Edge ↻K147 	AOAMT123604PEER-H	M	E	●	●	●	●	●	●	●	●	●	●	●	12	10	6.6	3.6	1.6	0.4	
	AOAMT123608PEER-H	M	E	●	●	●	●	●	●	●	●	●	●	●	12	10	6.6	3.6	1.2	0.8	
	AOAMT123616PEER-H	M	E	●	●	●	●	●	●	●	●	●	●	●	12	10	6.6	3.6	0.4	1.6	
APX3000 ↻K133 APX3000 Long Cutting Edge ↻K147 	AOAMT123602PEER-M	M	E	●	●	●	●	●	●	●	●	●	●	●	12	10	6.6	3.6	1.8	0.2	
	AOAMT123604PEER-M	M	E	●	●	●	●	●	●	●	●	●	●	●	12	10	6.6	3.6	1.6	0.4	
	AOAMT123608PEER-M	M	E	●	●	●	●	●	●	●	●	●	●	●	12	10	6.6	3.6	1.2	0.8	
	AOAMT123610PEER-M	M	E	●	●	●	●	●	●	●	●	●	●	●	12	10	6.6	3.6	1.0	1.0	
	AOAMT123612PEER-M	M	E	●	●	●	●	●	●	●	●	●	●	●	12	10	6.6	3.6	0.8	1.2	
	AOAMT123616PEER-M	M	E	●	●	●	●	●	●	●	●	●	●	●	12	10	6.6	3.6	0.4	1.6	
	AOAMT123620PEER-M	M	E	●	●	●	●	●	●	●	●	●	●	●	12	10	6.6	3.6	0.4	2.0	
	AOAMT123624PEER-M	M	E	●	●	●	●	●	●	●	●	●	●	●	12	10	6.6	3.6	0.4	2.4	
	AOAMT123630PEER-M	M	E	●	●	●	●	●	●	●	●	●	●	●	12	10	6.6	3.6	0.4	3.0	
AOAMT123632PEER-M	M	E	●	●	●	●	●	●	●	●	●	●	●	12	10	6.6	3.6	0.4	3.2		
APX4000 ↻K140 APX4000 Long Cutting Edge ↻K151 	AOAMT184804PEER-H	M	E	●	●	●	●	●	●	●	●	●	●	●	18	15	9	4.8	1.8	0.4	
	AOAMT184808PEER-H	M	E	●	●	●	●	●	●	●	●	●	●	●	18	15	9	4.8	1.4	0.8	
	AOAMT184816PEER-H	M	E	●	●	●	●	●	●	●	●	●	●	●	18	15	9	4.8	0.4	1.6	
	AOAMT184832PEER-H	M	E		●	●							●	●	18	15	9	4.8	0.4	3.2	
	AOAMT184840PEER-H	M	E		●	●							●	●	18	15	9	4.8	0.4	4.0	
	AOAMT184850PEER-H	M	E		●	●							●	●	18	15	9	4.8	—	5.0	
	AOAMT184864PEER-H	M	E		●	●							●	●	18	15	9	4.8	—	6.35	
APX4000 ↻K140 APX4000 Long Cutting Edge ↻K151 	AOAMT184804PEER-M	M	E	●	●	●	●	●	●	●	●	●	●	●	18	15	9	4.8	1.8	0.4	
	AOAMT184808PEER-M	M	E	●	●	●	●	●	●	●	●	●	●	●	18	15	9	4.8	1.4	0.8	
	AOAMT184810PEER-M	M	E	●			●	●	●				●	●	18	15	9	4.8	1.0	1.0	
	AOAMT184812PEER-M	M	E	●			●	●	●				●	●	18	15	9	4.8	0.8	1.2	
	AOAMT184816PEER-M	M	E	●	●	●	●	●	●	●	●	●	●	●	18	15	9	4.8	0.4	1.6	
	AOAMT184820PEER-M	M	E	●			●	●	●				●	●	18	15	9	4.8	0.4	2.0	

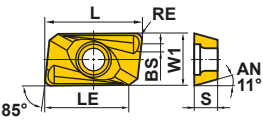
● : Inventory maintained. ★ : Inventory maintained in Japan.
(10 inserts in one case)

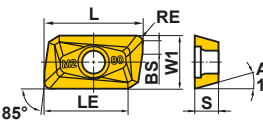

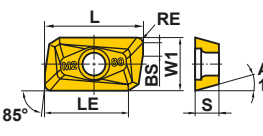







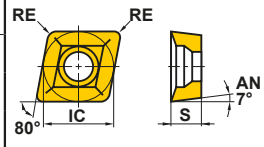

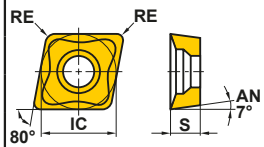
● ★ = NEW

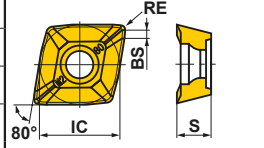
Work Material	P	Steel	●	●	●	●	●	●	Cutting Conditions (Guide): ●: Stable Cutting ●: General Cutting ✖: Unstable Cutting Honing: E: Round F: Sharp													
	M	Stainless Steel	●	●	●	●	●	●														
	K	Cast Iron	✖	✖	✖	✖	✖	✖														
N	Non-ferrous Metal	●	●	●	●	●	●	●	Coated Cermet Carbide													
	S	Heat-resistant Alloy, Titanium Alloy	●	●	●	●	●	●														
H	Hardened Materials	●	●	●	●	●	●	●	Dimensions (mm)													
Shape	Order Number	Class	Honing	Coated						Cermet						Carbide						Geometry
				F7030	VP15TF	UP20M	NX2525	NX4545	UT120T	HT110	L	LE	W1	S	BS	RE						
	BAE	AEMW150304ER	M	E			★	●	●				16.696	15.2	9.525	3.18	—	0.4				
		AEMW150308ER	M	E			★	★	●				16.623	14.8	9.525	3.18	—	0.8				
		AEMW19T304ER	M	E			★	●					20.161	18.4	12.7	3.97	—	0.4				
		AEMW19T308ER	M	E			★	★					20.088	18.0	12.7	3.97	—	0.8				
	BAP300	APGT1135PDRF-G2	G	F								●	11.3	9.7	6.35	3.5	1.2	0.8				
	BAP400	APGT1604PDRF-G2	G	F								●	17.02	14	9.525	4.76	1.4	0.8				
	BAP300	APMT1135PDER-H1	M	E	●	●		●	★	●			11.25	9	6.35	3.5	1.5	0.4				
	SRM2	APMT1135PDER-H2	M	E	●	●		●	●	●			11.25	9	6.35	3.5	1.2	0.8				
	Ⓚ220	APMT1135PDER-H3	M	E	●								11.26	9	6.35	3.5	0.8	1.2				
		APMT1135PDER-H4	M	E	●								11.24	9	6.35	3.5	0.4	1.6				
		APMT1135PDER-H6	M	E	●								11.10	9	6.35	3.5	0.4	2.4				
	BAP400	APMT1604PDER-H1	M	E	●		●						17.02	14	9.525	4.76	1.7	0.4				
	SRM2	APMT1604PDER-H2	M	E	●	●		●	●	●			17.11	14	9.525	4.76	1.4	0.8				
	Ⓚ220	APMT1604PDER-H4	M	E	●								17.06	14	9.525	4.76	0.4	1.6				
	SRM2φ40	APMT1604PDER-H6	M	E	●								16.93	14	9.525	4.76	0.4	2.4				
	φ50	APMT1604PDER-H8	M	E	●								16.79	14	9.525	4.76	0.4	3.2				
	BAP300	APMT1135PDER-M0	M	E	★								11.25	9	6.35	3.5	1.8	0.2				
	SRM2	APMT1135PDER-M1	M	E	★								11.25	9	6.35	3.5	1.5	0.4				
	Ⓚ220	APMT1135PDER-M2	M	E	●	●		●					11.18	9	6.35	3.5	1.2	0.8				
	BAP400	APMT1604PDER-M2	M	E	●	●		●					17.10	14	9.525	4.76	1.4	0.8				
	SRM2																					

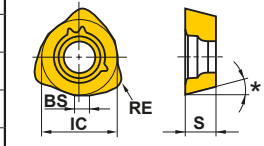
ROTATING INSERTS

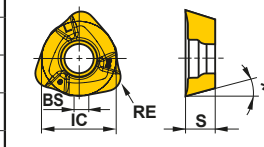
ROTATING INSERTS

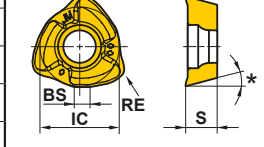
ROTATING INSERTS

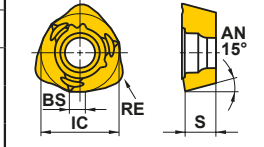
Work Material	P	Steel	●	●	●	●	●	●	●	●	●	●	●	Cutting Conditions (Guide): ●: Stable Cutting ●: General Cutting ✖: Unstable Cutting								
	M	Stainless Steel	●	●	●	●	●	●	●	●	●	●	●									
	K	Cast Iron	●	●	●	●	●	●	●	●	●	●	●									
N	Non-ferrous Metal	●	●	●	●	●	●	●	●	●	●	●	Honing: E: Round S: Chamfer + Honed									
S	Heat-resistant Alloy, Titanium Alloy	●	●	●	●	●	●	●	●	●	●	●										
H	Hardened Materials	●	●	●	●	●	●	●	●	●	●	●										
Shape	Order Number	Class	Honing	Coated										Carbide	Dimensions (mm)				Geometry			
				F7030	FH7020	MP6120	MP6130	MP7130	MP7140	MP9120	MP9130	MP9140	VP15TF	VP30RT	UP20M	UTi20T	IC	S		BS	RE	
	DCCC ↻K200 CCMX083508EN-A	M	E	●												★	★	7.94	3.5	—	0.8	
	CCMX09T308EN-A	M	E	●												●	★	★	9.525	3.97	—	
	DCCC ↻K200 CCMX09T308EN-B	M	E	●													★	9.525	3.97	—	0.8	
	PMR ↻K236 CPMT1205ZPEN-M2	M	E													●		12.7	5.56	1.4	0.8	
	CPMT1205ZPEN-M3	M	E													★		12.7	5.56	1.4	1.2	
	CPMT1906ZPEN-M2	M	E													●		19.05	6.35	1.4	0.8	
	CPMT1906ZPEN-M3	M	E													★		19.05	6.35	1.4	1.2	
	AJX ↻K180 JOMW06T215ZZSR-FT	M	S	●	●	●	●	●	●	●	●	●	●	●	●	●		6.35	2.78	1.2	1.5	
	JOMW080320ZZSR-FT	M	S	●	●	●	●	●	●	●	●	●	●	●	●	●		8	3.18	1.4	2	
	JDMW09T320ZDSR-FT	M	S	●	●	●	●	●	●	●	●	●	●	●	●	●		9.525	3.97	1.8	2	
	JDMW120420ZDSR-FT	M	S	●	●	●	●	●	●	●	●	●	●	●	●	●		12	4.76	2.5	2	
	JDMW140520ZDSR-FT	M	S	●	●	●	●	●	●	●	●	●	●	●	●	●		14	5.56	2.8	2	
*JOMW... : 13°, JDMW... : 15°																						
	AJX ↻K180 JOMT06T216ZZER-JL	M	E													●		6.35	2.78	1.2	1.6	
	JOMT080322ZZER-JL	M	E													●		8	3.18	1.4	2.2	
	JDMT09T323ZDER-JL	M	E													●		9.525	3.97	1.8	2.3	
	JDMT120423ZDER-JL	M	E													●		12	4.76	2.5	2.3	
	JDMT140523ZDER-JL	M	E													●		14	5.56	2.8	2.3	
*JOMT... : 13°, JDMT... : 15°																						
	AJX ↻K180 JOMT06T215ZZSR-JM	M	S	●	●	●	●	●	●	●	●	●	●	●	●	●		6.35	2.78	1.2	1.5	
	JOMT080320ZZSR-JM	M	S	●	●	●	●	●	●	●	●	●	●	●	●	●		8	3.18	1.4	2	
	JDMT09T320ZDSR-JM	M	S	●	●	●	●	●	●	●	●	●	●	●	●	●		9.525	3.97	1.8	2	
	JDMT120420ZDSR-JM	M	S	●	●	●	●	●	●	●	●	●	●	●	●	●		12	4.76	2.5	2	
	JDMT140520ZDSR-JM	M	S	●	●	●	●	●	●	●	●	●	●	●	●	●		14	5.56	2.8	2	
*JOMT... : 13°, JDMT... : 15°																						
	AJX ↻K180 JDMT120420ZDSR-ST	M	S	●	●	●	●	●								●		12	4.76	2.5	2	
	JDMT140520ZDSR-ST	M	S	●	●	●	●	●								●		14	5.56	2.8	2	

● = NEW



● : Inventory maintained. ★ : Inventory maintained in Japan.
(10 inserts in one case)

Work Material	P	Steel	●	●	●	●	●	●	●	●	●	●	●	●	●	Cutting Conditions (Guide): ●: Stable Cutting ●: General Cutting ✖: Unstable Cutting											
	M	Stainless Steel	●	●	●	●	●	●	●	●	●	●	●	●	●												
Work Material	K	Cast Iron	●	●	●	●	●	●	●	●	●	●	●	●	●	Honing: E: Round S: Chamfer + Hone											
	N	Non-ferrous Metal	●	●	●	●	●	●	●	●	●	●	●	●	●												
	S	Heat-resistant Alloy, Titanium Alloy	●	●	●	●	●	●	●	●	●	●	●	●	●												
Work Material	H	Hardened Materials	●	●	●	●	●	●	●	●	●	●	●	●	●												
Shape	Order Number	Class	Honing	Coated										Carbide	Dimensions (mm)						Geometry						
				MC7020	MP6120	MP6130	MP7130	MP7140	MP9120	MP9130	NEW MP9140	VP15TF	VP20RT	VP30RT	UP20M	UTi20T	L	LE	IC	S		BS	RE				
	WJX09	JOMU090512ZZER-L	M	E	●	●	●	●	●	●	●	●	●	●	●	●	●	●	●	●	●	●	●	●			
	⊕K072	JOMU140715ZZER-L	M	E	●	●	●	●	●	●	●	●	●	●	●	●	●	●	●	●	●	●	●	●		Right hand insert only.	
	WJX14	JOMU090512ZZER-M	M	E	●	●	●	●	●	●	●	●	●	●	●	●	●	●	●	●	●	●	●	●			
	⊕K079	JOMU140715ZZER-M	M	E	●	●	●	●	●	●	●	●	●	●	●	●	●	●	●	●	●	●	●	●			
		JOMU090512ZZER-R	M	E	●	●	●	●	●	●	●	●	●	●	●	●	●	●	●	●	●	●	●	●			
		JOMU140715ZZER-R	M	E	●	●	●	●	●	●	●	●	●	●	●	●	●	●	●	●	●	●	●	●			
	ASPX	JPGX1404080PPER-JM	G	E												●											
	⊕K208	JPGX1404120PPER-JM	G	E												●											
	NEW	JPGX1404160PPER-JM	G	E												●											
		JPGX1404240PPER-JM	G	E												●											
		JPGX1404320PPER-JM	G	E												●											
		JPGX1404400PPER-JM	G	E												●											
		JPGX1404500PPER-JM	G	E												●											
		JPGX1404635PPER-JM	G	E												●											
	TAB	JPMT060204-E	M	E												●	●	●									
	SPX	JPMX140412-JM	M	E												●	●										
	⊕K203	JPMX190412-JM	M	E												●	●										
	SPX	JPMX140412-WH	M	E												●	●										
	⊕K203	JPMX190412-WH	M	E												●	●										

● ★ = NEW

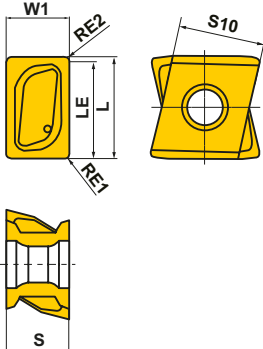

ROTATING INSERTS

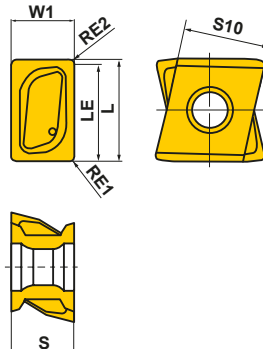
ROTATING INSERTS

Work Material	P	Steel	Coated	MP6120 VP15TF	Cutting Conditions (Guide):							Honing: E: Round	
	M	Stainless Steel			●	Stable Cutting	●	General Cutting	✚	Unstable Cutting			
	K	Cast Iron											
Shape	N	Non-ferrous Metal	Hand	Class	Honing	Dimensions (mm)							Geometry
	S	Heat-resistant Alloy, Titanium Alloy				L	LE	S	S10	RE1	RE2	W1	
	H	Hardened Steel											
DCV3 Side Cutter 	LNGU090604PNER-M	R	G	E	●	9.0	8.6	6.0	8.5	0.4	0.4	6.0	
	LNGU090604PNEL-M	L	G	E	●	9.0	8.6	6.0	8.5	0.4	0.4	6.0	
	LNGU090608PNER-M	R	G	E	●	9.0	8.6	6.0	8.5	0.8	0.4	6.0	
	LNGU090608PNEL-M	L	G	E	●	9.0	8.6	6.0	8.5	0.8	0.4	6.0	
	LNGU090612PNER-M	R	G	E	●	9.0	8.6	6.0	8.5	1.2	0.4	6.0	
	LNGU090612PNEL-M	L	G	E	●	9.0	8.6	6.0	8.5	1.2	0.4	6.0	
	LNGU090616PNER-M	R	G	E	●	9.0	8.6	6.0	8.5	1.6	0.4	6.0	
	LNGU090616PNEL-M	L	G	E	●	9.0	8.6	6.0	8.5	1.6	0.4	6.0	
	LNGU090620PNER-M	R	G	E	●	9.0	8.6	6.0	8.5	2.0	0.4	6.0	
	LNGU090620PNEL-M	L	G	E	●	9.0	8.6	6.0	8.5	2.0	0.4	6.0	
	LNGU090624PNER-M	R	G	E	●	9.0	8.6	6.0	8.5	2.4	0.4	6.0	
	LNGU090624PNEL-M	L	G	E	●	9.0	8.6	6.0	8.5	2.4	0.4	6.0	
	LNGU090630PNER-M	R	G	E	●	9.0	8.6	6.0	8.5	3.0	0.4	6.0	
	LNGU090630PNEL-M	L	G	E	●	9.0	8.6	6.0	8.5	3.0	0.4	6.0	
	LNGU090640PNER-M	R	G	E	●	9.0	8.6	6.0	8.5	4.0	0.4	6.0	
LNGU090640PNEL-M	L	G	E	●	9.0	8.6	6.0	8.5	4.0	0.4	6.0	Right hand insert shown.	
DCV4 Side Cutter 	LNGU130804PNER-M	R	G	E	●	13.0	12.2	8.0	11.0	0.4	0.8	8.0	
	LNGU130804PNEL-M	L	G	E	●	13.0	12.2	8.0	11.0	0.4	0.8	8.0	
	LNGU130808PNER-M	R	G	E	●	13.0	12.2	8.0	11.0	0.8	0.8	8.0	
	LNGU130808PNEL-M	L	G	E	●	13.0	12.2	8.0	11.0	0.8	0.8	8.0	
	LNGU130820PNER-M	R	G	E	●	13.0	12.2	8.0	11.0	2.0	0.8	8.0	
	LNGU130820PNEL-M	L	G	E	●	13.0	12.2	8.0	11.0	2.0	0.8	8.0	
	LNGU130830PNER-M	R	G	E	●	13.0	11.4	8.0	11.0	3.0	1.6	8.0	
	LNGU130830PNEL-M	L	G	E	●	13.0	11.4	8.0	11.0	3.0	1.6	8.0	
	LNGU130840PNER-M	R	G	E	●	13.0	11.4	8.0	11.0	4.0	1.6	8.0	
	LNGU130840PNEL-M	L	G	E	●	13.0	11.4	8.0	11.0	4.0	1.6	8.0	
	LNGU130850PNER-M	R	G	E	●	13.0	11.4	8.0	11.0	5.0	1.6	8.0	
	LNGU130850PNEL-M	L	G	E	●	13.0	11.4	8.0	11.0	5.0	1.6	8.0	
	NEW LNGU130804PNER-R	R	G	E	● ●	13.0	12.2	8.0	11.0	0.4	0.8	8.0	
	NEW LNGU130804PNEL-R	L	G	E	● ●	13.0	12.2	8.0	11.0	0.4	0.8	8.0	
	NEW LNGU130808PNER-R	R	G	E	● ●	13.0	12.2	8.0	11.0	0.8	0.8	8.0	
	NEW LNGU130808PNEL-R	L	G	E	● ●	13.0	12.2	8.0	11.0	0.8	0.8	8.0	
	NEW LNGU130812PNER-R	R	G	E	● ●	13.0	12.2	8.0	11.0	1.2	0.8	8.0	
	NEW LNGU130812PNEL-R	L	G	E	● ●	13.0	12.2	8.0	11.0	1.2	0.8	8.0	
	NEW LNGU130816PNER-R	R	G	E	● ●	13.0	12.2	8.0	11.0	1.6	0.8	8.0	
	NEW LNGU130816PNEL-R	L	G	E	● ●	13.0	12.2	8.0	11.0	1.6	0.8	8.0	
NEW LNGU130820PNER-R	R	G	E	● ●	13.0	12.2	8.0	11.0	2.0	0.8	8.0		
NEW LNGU130820PNEL-R	L	G	E	● ●	13.0	12.2	8.0	11.0	2.0	0.8	8.0	Right hand insert shown.	

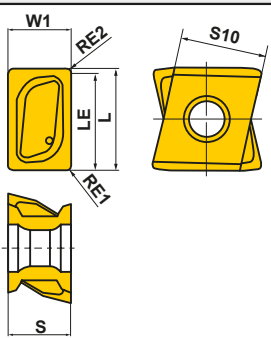

● = NEW

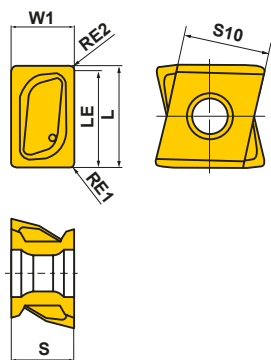
● : Inventory maintained.
(10 inserts in one case)

Work Material	P	Steel	Coated	MP6120	VP15TF	Cutting Conditions (Guide):							Geometry						
	M	Stainless Steel				●: Stable Cutting ●: General Cutting ✖: Unstable Cutting													
Shape	K	Cast Iron	L	G	E	L	LE	S	S10	RE1	RE2	W1							
	N	Non-ferrous Metal											Honing:						
	S	Heat-resistant Alloy, Titanium Alloy											E: Round						
H	Hardened Steel																		
DCV4 Side Cutter 	NEW LNGU130824PNER-R	R	G	E	●	●	13.0	12.2	8.0	11.0	2.4	0.8	8.0	 Right hand insert shown.					
	NEW LNGU130824PNEL-R	L	G	E	●	●	13.0	12.2	8.0	11.0	2.4	0.8	8.0						
	NEW LNGU130830PNER-R	R	G	E	●	●	13.0	11.4	8.0	11.0	3.0	1.6	8.0						
	NEW LNGU130830PNEL-R	L	G	E	●	●	13.0	11.4	8.0	11.0	3.0	1.6	8.0						
	NEW LNGU130840PNER-R	R	G	E	●	●	13.0	11.4	8.0	11.0	4.0	1.6	8.0						
	NEW LNGU130840PNEL-R	L	G	E	●	●	13.0	11.4	8.0	11.0	4.0	1.6	8.0						
	NEW LNGU130850PNER-R	R	G	E	●	●	13.0	11.4	8.0	11.0	5.0	1.6	8.0						
DCV5 Side Cutter 	LNGU171004PNER-R	R	G	E	●	●	17.0	16.2	10.0	13.0	0.4	0.8	10.0	 Right hand insert shown.					
	LNGU171004PNEL-R	L	G	E	●	●	17.0	16.2	10.0	13.0	0.4	0.8	10.0						
	LNGU171008PNER-R	R	G	E	●	●	17.0	16.2	10.0	13.0	0.8	0.8	10.0						
	LNGU171008PNEL-R	L	G	E	●	●	17.0	16.2	10.0	13.0	0.8	0.8	10.0						
	LNGU171012PNER-R	R	G	E	●	●	17.0	16.2	10.0	13.0	1.2	0.8	10.0						
	LNGU171012PNEL-R	L	G	E	●	●	17.0	16.2	10.0	13.0	1.2	0.8	10.0						
	LNGU171016PNER-R	R	G	E	●	●	17.0	16.2	10.0	13.0	1.6	0.8	10.0						
	LNGU171016PNEL-R	L	G	E	●	●	17.0	16.2	10.0	13.0	1.6	0.8	10.0						
	LNGU171020PNER-R	R	G	E	●	●	17.0	16.2	10.0	13.0	2.0	0.8	10.0						
	LNGU171020PNEL-R	L	G	E	●	●	17.0	16.2	10.0	13.0	2.0	0.8	10.0						
	LNGU171024PNER-R	R	G	E	●	●	17.0	16.2	10.0	13.0	2.4	0.8	10.0						
	LNGU171024PNEL-R	L	G	E	●	●	17.0	16.2	10.0	13.0	2.4	0.8	10.0						
	LNGU171030PNER-R	R	G	E	●	●	17.0	15.4	10.0	13.0	3.0	1.6	10.0						
	LNGU171030PNEL-R	L	G	E	●	●	17.0	15.4	10.0	13.0	3.0	1.6	10.0						
	LNGU171040PNER-R	R	G	E	●	●	17.0	15.4	10.0	13.0	4.0	1.6	10.0						
	LNGU171040PNEL-R	L	G	E	●	●	17.0	15.4	10.0	13.0	4.0	1.6	10.0						
	LNGU171050PNER-R	R	G	E	●	●	17.0	15.4	10.0	13.0	5.0	1.6	10.0						
	LNGU171050PNEL-R	L	G	E	●	●	17.0	15.4	10.0	13.0	5.0	1.6	10.0						
	LNGU171060PNER-R	R	G	E	●	●	17.0	15.4	10.0	13.0	6.0	1.6	10.0						
	LNGU171060PNEL-R	L	G	E	●	●	17.0	15.4	10.0	13.0	6.0	1.6	10.0						
LNGU171070PNER-R	R	G	E	●	●	17.0	15.4	10.0	13.0	7.0	1.6	10.0							
LNGU171070PNEL-R	L	G	E	●	●	17.0	15.4	10.0	13.0	7.0	1.6	10.0							

● = NEW

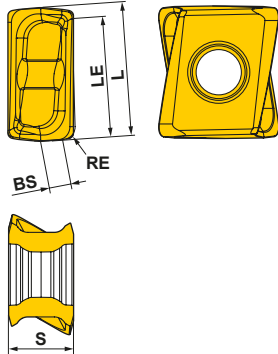

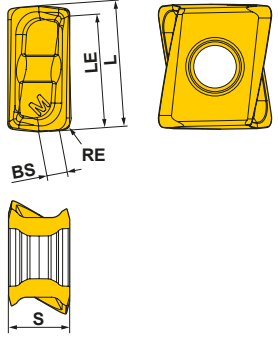

ROTATING INSERTS

Work Material	P	Steel											Cutting Conditions (Guide): ●: Stable Cutting ●: General Cutting ✦: Unstable Cutting Honing: E: Round F: Sharp					
	M	Stainless Steel																
	K	Cast Iron																
Shape	Order Number	Class	Honing	Coated							Carbide	Dimensions (mm)					Geometry	
				MC5020	MP6120	MP6130	MP7130	MP9120	MP9130	VP15TF	TF15	L	RE	LE	S	BS		
VPX200 ↻K086 VPX200 Long Cutting Edge ↻K114 NEW 	LOGU0904020PNER-L	G	E	★	★	★	★	★	★	★			8.7	0.2	7.6	4.3	1.7	
	LOGU0904040PNER-L	G	E	●	●	●	●	●	●	★			8.7	0.4	7.6	4.3	1.5	
	LOGU0904080PNER-L	G	E	●	●	●	●	●	●	★			8.7	0.8	7.6	4.3	1.2	
	LOGU0904100PNER-L	G	E	★	★	★	★	★	★	★			8.7	1.0	7.6	4.3	1.0	
	LOGU0904120PNER-L	G	E	★	★	★	★	★	★	★			8.7	1.2	7.6	4.3	0.8	
	LOGU0904160PNER-L	G	E	●	●	●	●	●	●	★			8.7	1.6	7.6	4.3	0.5	
	LOGU0904020PNFR-L	G	F								●		8.7	0.2	7.6	4.3	1.7	
	LOGU0904040PNFR-L	G	F								●		8.7	0.4	7.6	4.3	1.5	
	LOGU0904080PNFR-L	G	F								●		8.7	0.8	7.6	4.3	1.2	
	LOGU0904100PNFR-L	G	F								★		8.7	1.0	7.6	4.3	1.0	
	LOGU0904120PNFR-L	G	F								★		8.7	1.2	7.6	4.3	0.8	
	LOGU0904160PNFR-L	G	F								★		8.7	1.6	7.6	4.3	0.5	
VPX200 ↻K086 VPX200 Long Cutting Edge ↻K114 	LOGU0904020PNER-M	G	E	★	★	★	★	★	★	★			8.7	0.2	7.6	4.3	1.7	
	LOGU0904040PNER-M	G	E	●	●	●	●	●	●	★			8.7	0.4	7.6	4.3	1.6	
	LOGU0904080PNER-M	G	E	●	●	●	●	●	●	★			8.7	0.8	7.6	4.3	1.2	
	LOGU0904100PNER-M	G	E	★	★	★	★	★	★	★			8.7	1.0	7.6	4.3	1.0	
	LOGU0904120PNER-M	G	E	★	★	★	★	★	★	★			8.7	1.2	7.6	4.3	0.9	
	LOGU0904160PNER-M	G	E	●	●	●	●	●	●	★			8.7	1.6	7.6	4.3	0.5	
	LOGU0904020PNFR-M	G	F								●		8.7	0.2	7.6	4.3	1.7	
	LOGU0904040PNFR-M	G	F								●		8.7	0.4	7.6	4.3	1.6	
	LOGU0904080PNFR-M	G	F								●		8.7	0.8	7.6	4.3	1.2	
	LOGU0904100PNFR-M	G	F								★		8.7	1.0	7.6	4.3	1.0	
	LOGU0904120PNFR-M	G	F								★		8.7	1.2	7.6	4.3	0.9	
	LOGU0904160PNFR-M	G	F								★		8.7	1.6	7.6	4.3	0.5	

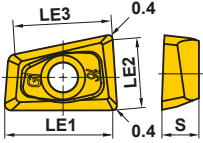

● ★ = NEW

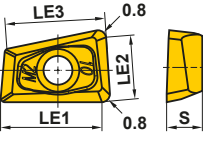
● : Inventory maintained. ★ : Inventory maintained in Japan.
 (10 inserts in one case)

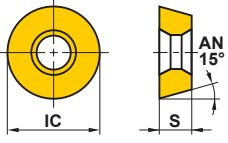
ROTATING INSERTS

Work Material	P	Steel	●	●	●	●	●	●	●	●	●	●	●	●	●	●	Cutting Conditions (Guide): ●: Stable Cutting ●: General Cutting ✖: Unstable Cutting Honing: E: Round F: Sharp S: Chamfer + Hone							
	M	Stainless Steel	●	●	●	●	●	●	●	●	●	●	●	●	●	●								
	K	Cast Iron	●	●	●	●	●	●	●	●	●	●	●	●	●	●								
N	Non-ferrous Metal	●	●	●	●	●	●	●	●	●	●	●	●	●	●	●								
S	Heat-resistant Alloy, Titanium Alloy	●	●	●	●	●	●	●	●	●	●	●	●	●	●	●								
H	Hardened Materials	●	●	●	●	●	●	●	●	●	●	●	●	●	●	●								
Shape	Order Number	Class	Honing	Coated										Carbide	Dimensions (mm)					Geometry				
				F7030	MP6120	MP6130	MP7130	MP7140	MP9120	VP15TF	VP30RT	VP10H	VP05HT	MP8010	HTi10	LE1	LE2	LE3	IC		S			
	AQX K172	QOGT0830R-G1	G	E *1	★					★	●					●	7.7	4.9	7.3	—	3			
		QOGT1035R-G1	G	E *1	★					★	●					●	9.9	6.4	9.3	—	3.5			
		QOGT1342R-G1	G	E *1	★					★	●					●	12.4	8.1	11.6	—	4.2			
		QOGT1651R-G1	G	E *1	★					★	●					●	15.8	10.4	14.6	—	5.1			
		QOGT1856R-G1	G	E *1	★					★	●					●	17.3	11.4	16	—	5.6			
		QOGT2062R-G1	G	E *1	★					★	●					●	19.8	13.1	18.1	—	6.2			
		QOGT2576R-G1	G	E *1	★					★	●					●	25.2	16.6	23.1	—	7.6			
	AQX K172	QOMT0830R-M2	M	E	●	●	●	●	●	●	●	●	●	●	●		7.3	4.4	7.3	—	3			
		QOMT1035R-M2	M	E	●	●	●	●	●	●	●	●	●	●	●	●		9.5	5.9	9.3	—		3.5	
		QOMT1342R-M2	M	E	●	●	●	●	●	●	●	●	●	●	●	●		12	7.6	11.6	—		4.2	
		QOMT1651R-M2	M	E	●	●	●	●	●	●	●	●	●	●	●	●		15.4	9.9	14.6	—		5.1	
		QOMT1856R-M2	M	E	●	●	●	●	●	●	●	●	●	●	●	●		16.9	10.9	16	—		5.6	
		QOMT2062R-M2	M	E	●	●	●	●	●	●	●	●	●	●	●	●		19.4	12.6	18.1	—		6.2	
		QOMT2576R-M2	M	E	●	●	●	●	●	●	●	●	●	●	●	●		24.8	16.1	23.1	—		7.6	
	RRD	RDHX0501M0E	H	E	●						●	●	●				—	—	—	5	1.5			
		RDHX0501M0S	H	S	●						●	●						—	—	—	5		1.5	
		RDHX07T1M0E	H	E	●						●	●	●					—	—	—	7		1.98	
		RDHX07T1M0S	H	S	●						●	●	●						—	—	—		7	1.98
		RDHX0702M0E	H	E	●						●	●	●						—	—	—		7	2.38
		RDHX0702M0S	H	S	●						●	●							—	—	—		7	2.38
		RDHX1003M0E	H	E	●						●	●	●						—	—	—		10	3.18
		RDHX1003M0S	H	S	●						●	●	●						—	—	—		10	3.18
		RDHX12T3M0E	H	E	●						●	●	●						—	—	—		12	3.97
		RDHX12T3M0S	H	S	●						●	●							—	—	—		12	3.97
		RDHX1604M0E	H	E	●						●	●	●						—	—	—		16	4.76
		RDHX1604M0S	H	S	●						●	●							—	—	—		16	4.76

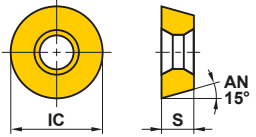

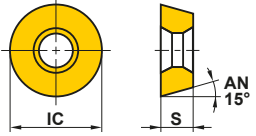
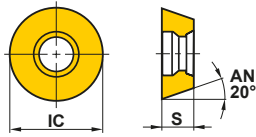
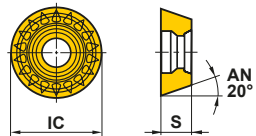
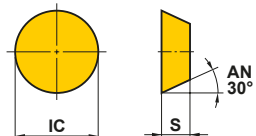



*1 Grade HTi10 is "F".

Work Material	P	Steel	●	●	●	●	●	●	●	●	●	●	●	Cutting Conditions (Guide): ●: Stable Cutting ●: General Cutting ✖: Unstable Cutting		
	M	Stainless Steel	●	●	●	●	●	●	●	●	●	●	●			
Work Material	K	Cast Iron	✖	●	●	●	●	●	●	●	●	●	●	Honing: E: Round S: Chamfer + Hone T: Chamfer		
	N	Non-ferrous Metal	●	●	●	●	●	●	●	●	●	●	●			
	S	Heat-resistant Alloy, Titanium Alloy	●	●	●	●	●	●	●	●	●	●	●			
Shape	Order Number	Class	Honing	Coated						Cermet	Carbide	Dimensions (mm)		Geometry		
				F7030	VP15TF	VP20M	VP10H	VP05HT	UP20M	NX4545	UT120T	HT110	IC		S	
	RRD	RDMX07T1M0E	M	E					●					7	1.98	
		RDMX07T1M0T	M	T	□	●	●							7	1.98	
		RDMX0702M0E	M	E					□					7	2.38	
		RDMX0702M0T	M	T	●	●	●							7	2.38	
		RDMX1003M0E	M	E					●					10	3.18	
		RDMX1003M0S	M	S		●	●							10	3.18	
		RDMX1003M0T	M	T	●	●	●			●	□			10	3.18	
		RDMX12T3M0E	M	E					●					12	3.97	
		RDMX12T3M0S	M	S		●	●							12	3.97	
		RDMX12T3M0T	M	T	●	●	●				□	□		12	3.97	
		RDMX1604M0E	M	E					●					16	4.76	
		RDMX1604M0S	M	S		●	●							16	4.76	
		RDMX1604M0T	M	T	●	●	●				□	□		16	4.76	
	RRD	RDZX0501M0E	Z	E		●								5	1.50	
		RDZX07T1M0E	Z	E		●								7	1.98	
		RDZX0702M0E	Z	E		●								7	2.38	
		RDZX1003M0E	Z	E		●								10	3.18	
		RDZX1003M0S	Z	S		●	●							10	3.18	
		RDZX12T3M0E	Z	E		●								12	3.97	
		RDZX12T3M0S	Z	S		●	●							12	3.97	
		RDZX1604M0E	Z	E		●								16	4.76	
		RDZX1604M0S	Z	S		●	●							16	4.76	
OCTACUT	REMX1705SN	M	S	★										17.25	5.2	
OCTACUT	REMX12T3EN-JS	M	E	★										12.95	4.17	
	REMX1705EN-JS	M	E	★										17.25	5.2	
SG20	RGEN2004M0EN	E	E	★										20	4.76	
	RGEN2004M0SN	E	S		●			●		●	●			20	4.76	

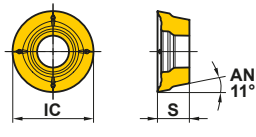
ROTATING INSERTS

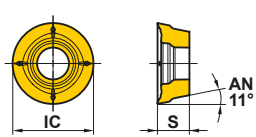
ROTATING INSERTS

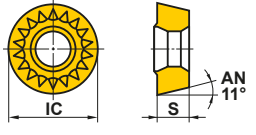
ROTATING INSERTS

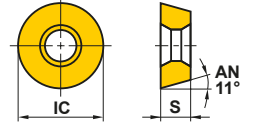
Work Material	P	Steel	●	●				●	●	●	●	●	Cutting Conditions (Guide): ●: Stable Cutting ●: General Cutting ✘: Unstable Cutting Honing: E: Round T: Chamfer					
	M	Stainless Steel	●	●	●			●	●	●	●							
	K	Cast Iron						✘	●	●	●	✘						
N	Non-ferrous Metal							✘	✘	●	●							
S	Heat-resistant Alloy, Titanium Alloy							✘	✘	●	●							
H	Hardened Materials									●	●							
Shape	Order Number	Class	Honing	Coated								Cermet	Carbide	Dimensions (mm)			Geometry	
				F7010	F7030	MC7020	MP7130	MP9130	NEW MP9140	VP15TF	AP20M	NX2525	NX4545	UT120T	IC	S		BS
	ARP5/6 K238	RPHT1040M0E4-L	H	E			●	●	●						10	3.97	—	
		RPHT1248M0E4-L	H	E			●	●	●						12	4.76	—	
		RPHT1040M0E4-M	H	E			●	●	●						10	3.97	—	
		RPHT1248M0E4-M	H	E			●	●	●						12	4.76	—	
		RPHT1040M0E4-R	H	E			●	●	●						10	3.97	—	
		RPHT1248M0E4-R	H	E			●	●	●						12	4.76	—	
	ARP5/6 K238	RPMT1040M0E4-L	M	E			●	●	●						10	3.97	—	
	NEW	RPMT1040M0E8-L1	M	E			●	●	●	●					10	3.97	—	
	NEW	RPMT1040M0E4-L2	M	E						●					10	3.97	—	
		RPMT1248M0E4-L	M	E			●	●	●						12	4.76	—	
	NEW	RPMT1248M0E8-L1	M	E			●	●	●	●					12	4.76	—	
	NEW	RPMT1248M0E4-L2	M	E						●					12	4.76	—	
		RPMT1040M0E4-M	M	E			●	●	●						10	3.97	—	
	NEW	RPMT1040M0E8-M1	M	E			●	●	●	●					10	3.97	—	
	NEW	RPMT1040M0E4-M2	M	E						●					10	3.97	—	
		RPMT1248M0E4-M	M	E			●	●	●						12	4.76	—	
	NEW	RPMT1248M0E8-M1	M	E			●	●	●	●					12	4.76	—	
	NEW	RPMT1248M0E4-M2	M	E						●					12	4.76	—	
		RPMT1040M0E4-R	M	E			●	●	●						10	3.97	—	
	NEW	RPMT1040M0E8-R1	M	E			●	●	●						10	3.97	—	
	RPMT1248M0E4-R	M	E			●	●	●						12	4.76	—		
NEW	RPMT1248M0E8-R1	M	E			●	●	●						12	4.76	—		
	BRP K190	RPMT08T2M0E-JS	M	E			●				●		●	8	2.78	—		
		RPMT10T3M0E-JS	M	E			●				●		●	10	3.97	—		
		RPMT1204M0E-JS	M	E	●	●					●	●	●	12	4.76	—		
		RPMT1606M0E-JS	M	E	●						●	●		16	6.35	—		
	BRP K190	RPMW08T2M0E	M	E									●	8	2.78	—		
		RPMW08T2M0T	M	T						●				8	2.78	—		
		RPMW10T3M0E	M	E	★							★	□	10	3.97	—		
		RPMW10T3M0T	M	T						●				10	3.97	—		
		RPMW1204M0E	M	E	●						●	□	●	●	12	4.76		—
		RPMW1204M0T	M	T						●		●		12	4.76	—		
		RPMW1606M0E	M	E	●						●	□	●	●	16	6.35		—
		RPMW1606M0T	M	T						●				16	6.35	—		

● = NEW

● : Inventory maintained. ★ : Inventory maintained in Japan.

□ : Non stock, produced to order only. (10 inserts in one case)

Work Material	P	Steel	●	●	●	●	●	●	●	Cutting Conditions (Guide): ●: Stable Cutting ●: General Cutting ✖: Unstable Cutting Honing: E: Round F: Sharp S: Chamfer + Hone T: Chamfer Z: Strong					
	M	Stainless Steel	●	●	●	●	●	●	●						
Shape	K	Cast Iron	●	●	●	●	●	●	●	Coated Cermet Carbide					
	N	Non-ferrous Metal	●	●	●	●	●	●	●		Dimensions (mm) IC S BS BCH RE				
	S	Heat-resistant Alloy, Titanium Alloy	●	●	●	●	●	●	●	Geometry					
H	Hardened Materials	●	●	●	●	●	●	●							
Corner Angle 45°	SDEN1203AEN	E	T					●		12.7	3.18	1.2	—	—	
LSE445 SE445	SEEN1203AFEN1	E	E					●		12.7	3.18	1.4	—	1.0	
	SEEN1203AFTN1	E	T			●				12.7	3.18	1.4	—	1.0	
	* SEEN1203AFTN3	E	T			●				12.7	3.18	1.4	0.77	—	
LSE445 SE445	SEER1203AFEN-JS	E	E	●	●	●	●			12.7	3.18	1.4	—	1.0	
Corner Angle 45°	SEER1204AFEN-JS	E	E	●						12.7	4.76	1.4	—	1.0	
SE545	SEEN1504AFEN1	E	E			★				15.875	4.76	1.4	—	1.0	
	SEEN1504AFTN1	E	T	□		●	★	●	●	15.875	4.76	1.4	—	1.0	
	* SEEN1504AFTN3	E	T	●						15.875	4.76	1.4	0.77	—	
	SEEN1504AFSN1	E	S	●	●					15.875	4.76	1.4	—	1.0	
SE545	SEER1504AFEN-JS	E	E	●	●	★				15.875	4.76	1.4	—	1.0	
SE415	SEEN1203EFFR1	E	F					●		12.7	3.18	1.4	—	1.0	
	SEEN1203EFER1	E	E			★				12.7	3.18	1.4	—	1.0	
	SEEN1203EFTR1	E	T				★	●		12.7	3.18	1.4	—	1.0	
	* SEEN1203EFTR3	E	T					●		12.7	3.18	1.4	—	—	
	SEEN1203EFSR1	E	S	●	●					12.7	3.18	1.4	—	1.0	

ROTATING INSERTS

* SEEN1203EFTR3
Right hand insert shown.

ROTATING INSERTS











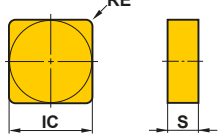

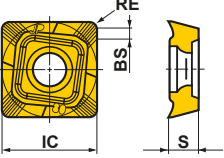
ROTATING INSERTS

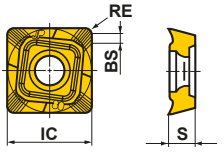
Work Material	P	Steel											Cutting Conditions (Guide):											
	M	Stainless Steel											●: Stable Cutting ●: General Cutting ✦: Unstable Cutting											
	K	Cast Iron											Honing:											
N	Non-ferrous Metal											E: Round F: Sharp S: Chamfer + Hone T: Chamfer												
S	Heat-resistant Alloy, Titanium Alloy																							
H	Hardened Materials																							
Shape	Order Number	Class	Honing	Coated										Cermet	Carbide	Dimensions (mm)				Geometry				
				F7030	MC5020	MP6120	MP6130	MP7130	MP7140	MP9120	MP9130	VP15TF	VP30RT	UP20M	NX2525	NX4545	UTi20T	HTi10	IC		S	BS	RE	
	SE415	SEER1203EFER-JS	E	E	●	★													12.7	3.18	1.4	1.0		
	SE515	SECN1504EFTR1	C	T									★						15.875	4.76	1.4	1.0		
		SEEN1504EFER1	E	E									★						15.875	4.76	1.4	1.0		
		SEEN1504EFTR1	E	T											●				15.875	4.76	1.4	1.0		
		SEEN1504EFSR1	E	S	●														15.875	4.76	1.4	1.0		
Corner Angle 45°		SEEW1204AFTN	E	T										●	●	●			12.7	4.76	2.6	1.0		
Corner Angle 45°		SEMN1204AZTN	M	T										●		●			12.7	4.76	2.0	0.2		
ASX445 K026		SEGT13T3AGFN-JP	G	F												●			13.4	3.97	2.2	—		
ASX445 K026		SEET13T3AGEN-JL	E	E	●	●	●	●	●	●	●	●	●	●	●	●				13.4	3.97	1.9	1.5	
ASX445 K026		SEMT13T3AGSN-FT	M	S	●														13.4	3.97	1.9	1.5		

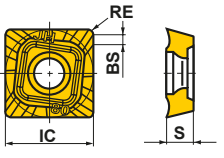
● : Inventory maintained. ★ : Inventory maintained in Japan.
(10 inserts in one case)

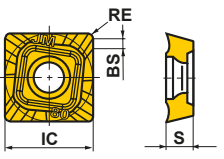
ROTATING INSERTS

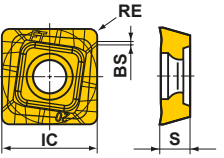

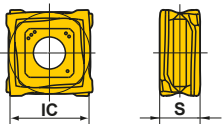



ROTATING INSERTS

Work Material	P	Steel	●	●	●	●	●	●	●	●	●	●	●	●	●	●	●	●	Cutting Conditions (Guide): ●: Stable Cutting ●: General Cutting ✖: Unstable Cutting Honing: E: Round F: Sharp			
	M	Stainless Steel	●	●	●	●	●	●	●	●	●	●	●	●	●	●	●	●				
	K	Cast Iron	●	●	●	●	●	●	●	●	●	●	●	●	●	●	●	●				
N	Non-ferrous Metal	●	●	●	●	●	●	●	●	●	●	●	●	●	●	●	●	●				
	S	Heat-resistant Alloy, Titanium Alloy	●	●	●	●	●	●	●	●	●	●	●	●	●	●	●	●				
H	Hardened Materials	●	●	●	●	●	●	●	●	●	●	●	●	●	●	●	●	●				
Shape	Order Number	Class	Honing	Coated										Cermet	Carbide	Dimensions (mm)				Geometry		
				F7030	MC5020	MP6120	MP6130	MP7130	MP7140	MP9120	MP9130	VP15TF	VP30RT	NX2525	NX4545	UT120T	HT110	IC	S		BS	RE
	SNMN120408	M	E	★											★	●	★	12.7	4.76	—	0.8	
	SNMN120412	M	E	●											★	●	●	12.7	4.76	—	1.2	
ASX400 ⓈK068 	SOET12T308PEER-JL	E	E	●	●	●	●	●	●	●	●	●	●	●	●	●	●	12.7	3.97	1.4	0.8	
ASX400 ⓈK068 	SOGT12T308PEFR-JP	G	F													●	●	12.7	3.97	1.4	0.8	
ASX400 ⓈK068 	SOMT12T308PEER-JH	M	E	●	●	●	●	●	●	●	●	●	●	●	●	●	●	12.7	3.97	1.4	0.8	
ASX400 ⓈK068 ASX400 Side Cutter 	SOMT12T308PEER-JM	M	E	●	●	●	●	●	●	●	●	●	●	●	●	●	●	12.7	3.97	1.4	0.8	
	SOMT12T308PEEL-JM	M	E													●	●	12.7	3.97	1.4	0.8	
ASX400 ⓈK068 	SOMT12T320PEER-FT	M	E	●	●				★	★	●							12.7	3.97	0.5	2.0	
VOX400 ⓈK065 	SONX1206PER	N	E	●												●		12.7	6.3	—	—	
	SONX1206PEL	N	E													★		12.7	6.3	—	—	

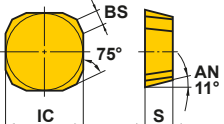

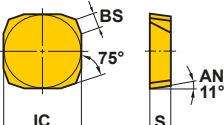

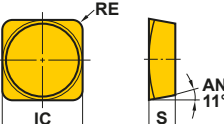

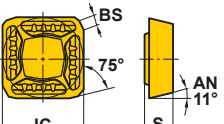
Right hand insert shown.

Right hand insert shown.

● : Inventory maintained. ★ : Inventory maintained in Japan.
 □ : Non stock, produced to order only. (10 inserts in one case)

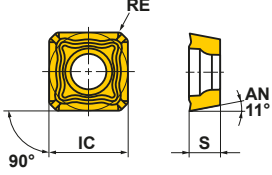
Work Material	P	Steel	●	●	●	●	●	●	Cutting Conditions (Guide): ●: Stable Cutting ●: General Cutting ✖: Unstable Cutting Honing: E: Round F: Sharp T: Chamfer				
	M	Stainless Steel	●	●	●	●	●	●					
Shape	K	Cast Iron	●	●	●	●	●	●	Coated Cermet Carbide Dimensions (mm) IC S BS RE Geometry				
	N	Non-ferrous Metal	●	●	●	●	●	●					
	S	Heat-resistant Alloy, Titanium Alloy	●	●	●	●	●	●					
Order Number	H	Hardened Materials	●	●	●	●	●	●	F7030 MC5020 UP20M NX2525 NX4545 UTi20T HTi10				
	Class	Honing											
Corner Angle 15° 	SPEN1203EDR	E	T	●			●	●	12.7	3.18	1.4	—	 Right hand insert shown.
	SPEN1203EDL	E	T *1				□	★ □	12.7	3.18	1.4	—	
	SPEN1504EDR	E	T *1		●		□	● □	15.875	4.76	1.4	—	
	SPEN1504EDL	E	T					●	15.875	4.76	1.4	—	
FBP415 	SPEN1203EEER1	E	E	●				★	12.7	3.175	1.4	—	 Right hand insert shown.
	SPEN1203EEEL1	E	E	★				★	12.7	3.175	1.4	—	
	SPNN1203EEER1	N	E	★				★	12.7	3.18	1.3	—	
	SPNN1203EEEL1	N	E					★	12.7	3.18	1.3	—	
FP490 	SPEN424A	E	F					★	12.7	3.18	—	1.6	
FBP415 	SPER1203EEER-JS	E	E	●					12.7	3.18	1.4	—	

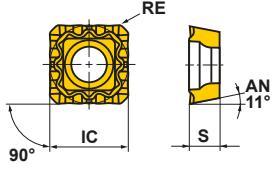

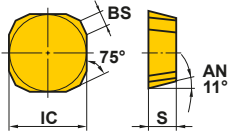





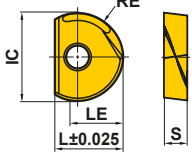

*1 Grade HTi10 is "F".

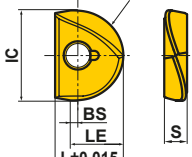
Work Material	P	Steel	●	●		●	Cutting Conditions (Guide): ●: Stable Cutting ●: General Cutting ✖: Unstable Cutting Honing: E: Round				
	M	Stainless Steel	●	●		●					
Work Material	K	Cast Iron	✖	✖		✖					
	N	Non-ferrous Metal									
	S	Heat-resistant Alloy, Titanium Alloy	●	✖							
Work Material	H	Hardened Materials	●								
Shape	Order Number	Class	Honing	Coated		Carbide	Dimensions (mm)				Geometry
				VP15TF	VP20RT	UT120T	IC	S	BS	RE	
SPX  	SPMX120408-JM	M	E	●	●		12.7	4.80	—	0.8	
SPX  	SPMX120408-WH	M	E	●	●		12.7	4.76	—	0.8	
Corner Angle 15° 	SPNN1203EDR	N	E			●	12.7	3.18	1.4	—	 Right hand insert shown.

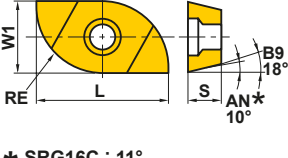
ROTATING INSERTS

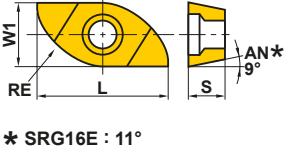
ROTATING INSERTS

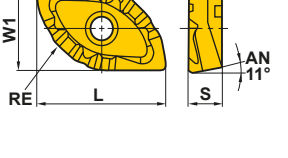
ROTATING INSERTS

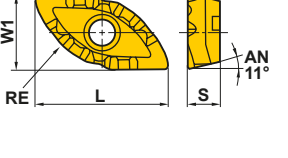





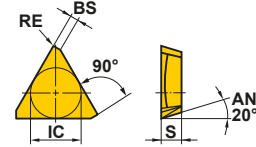

Shape	Order Number	Class	Honing	Coated						Dimensions (mm)						Geometry		
				EP6120	MP6120	MP9120	VP15TF	VP20RT	VP30RT	MP8010	RE	L	LE	W1	IC		S	BS
				Cutting Conditions (Guide): ●: Stable Cutting ●: General Cutting ✖: Unstable Cutting						Honing: E: Round F: Sharp								
Work Material		P	Steel	●	●	●	●	●	●	●	●	●	●	●	●	●		
		M	Stainless Steel	●	●	●	●	●	●	●	●	●	●	●	●	●		
		K	Cast Iron	●	●	●	●	●	●	●	●	●	●	●	●	●		
		N	Non-ferrous Metal	●	●	●	●	●	●	●	●	●	●	●	●	●		
		S	Heat-resistant Alloy, Titanium Alloy	●	●	●	●	●	●	●	●	●	●	●	●	●		
		H	Hardened Materials	●	●	●	●	●	●	●	●	●	●	●	●	●		
	* SRBT10	-	F				●											
	* SRBT12	-	F				●											
	* SRBT16	-	F				●											
	* SRBT20	-	F				●											
	* SRBT25	-	F				●											
	* SRBT30	-	F				●											
	* SRBT32	-	F				●											
	* SRFT10	-	F	●			●			●								
	* SRFT12	-	F	●			●			●								
	* SRFT16	-	F	●			●			●								
	* SRFT20	-	F	●			●			●								
	* SRFT25	-	F	●			●			●								
	* SRFT30	-	F	●			●			●								
	* SRFT32	-	F	●			●			●								
	SRG16C	G	E	●	★	●												
	SRG20C	G	E	●	★	●												
	SRG25C	G	E	●	★	●												
	SRG30C	G	E	●	★	●												
	SRG32C	G	E	●	★	●												
* SRG16C : 11°																		
	SRG16E	G	E	●	★	●												
	SRG20E	G	E	●	★	●												
	SRG25E	G	E	●	★	●												
	SRG30E	G	E	●	★	●												
	SRG32E	G	E	●	★	●												
* SRG16E : 11°																		
	* SRG40C	G	E				●	●	●									
	* SRG50C	G	E				●	●	●									
	* SRG40E	G	E				●	●	●									
	* SRG50E	G	E				●	●	●									

*2 inserts in one case.

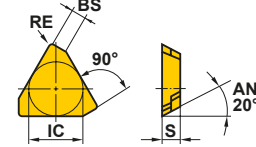

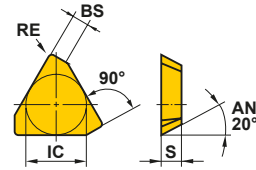

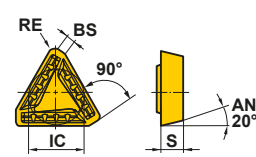

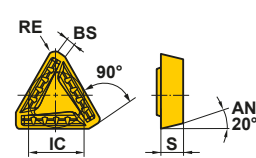
● : Inventory maintained. ★ : Inventory maintained in Japan.
(10 inserts in one case)

ROTATING INSERTS

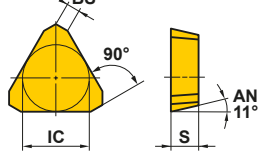
ROTATING INSERTS

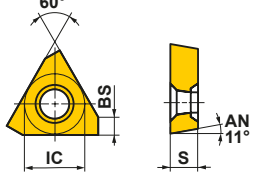
Work Material	P	Steel	●		●	●	●	●	Cutting Conditions (Guide): ●: Stable Cutting ●: General Cutting ✖: Unstable Cutting Honing: E: Round F: Sharp S: Chamfer + Hone T: Chamfer Z: Strong					
	M	Stainless Steel	●	●	●	●	●							
	K	Cast Iron	●	●	●	●	●							
N	Non-ferrous Metal	●	●	●	●	●	●							
	S	Heat-resistant Alloy, Titanium Alloy	●	●	●	●	●							
H	Hardened Materials	●	●	●	●	●	●							
Shape	Order Number	Class	Honing	Coated			Cermet	Carbide	Dimensions (mm)				Geometry	
				F7030	MC5020	VP15TF	UP20M	NX2525	NX4545	UTi20T	HTi10	IC		S
	TECN1603PEFR1W	C	F					★	9.525	3.175	1.4	0.4	Wall face finishing. 	
	TECN1603PEER1W	C	E					★	9.525	3.175	1.4	0.4		
	TECN1603PETR1W	C	T				★	★	★	9.525	3.175	1.4		0.4
	TEEN1603PEFR1	E	F					●	9.525	3.175	1.4	0.4		
	TEEN1603PEER1	E	E		★			●	9.525	3.175	1.4	0.4		
	TEEN1603PETR1	E	T			●	●	●	9.525	3.175	1.4	0.4		
	TEEN1603PESR1	E	S	●	●				9.525	3.175	1.4	0.4		
	TEEN1603PEZR1	E	Z				●		9.525	3.175	1.4	0.4		
	TECN2204PEFR1	C	F					★	12.7	4.76	1.4	1.0		
	TECN2204PEER1	C	E					★	12.7	4.76	1.4	1.0		
	TECN2204PETR1	C	T				★	★	★	12.7	4.76	1.4		1.0
	TEEN2204PEFR1	E	F					●	12.7	4.76	1.4	1.0		
	TEEN2204PEER1	E	E		★			●	12.7	4.76	1.4	1.0		
	TEEN2204PETR1	E	T			●	●	●	12.7	4.76	1.4	1.0		
	TEER1603PEER-JS	E	E	●				●	9.525	3.175	1.4	0.4		
	TEER2204PEER-JS	E	E	●				★	12.7	4.76	1.4	1.0		

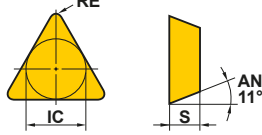
● : Inventory maintained. ★ : Inventory maintained in Japan.
 □ : Non stock, produced to order only. (10 inserts in one case)

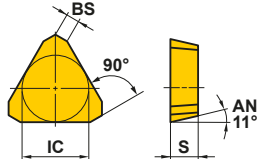
Work Material	P	Steel	●	●	●		●	●	●	Cutting Conditions (Guide): ●: Stable Cutting ●: General Cutting ✖: Unstable Cutting Honing: E: Round T: Chamfer					
	M	Stainless Steel	●	●	●		●	●	●						
Shape	K	Cast Iron	✖	✖	✖		●	●	●	Coated Cermet Carbide					
	N	Non-ferrous Metal													
	S	Heat-resistant Alloy, Titanium Alloy	●												
H	Hardened Materials	●													
Order Number	Class	Honing	F7030	VP15TF	UP20M	AP10H	NX2525	NX4545	UT120T	HT110	IC	S	BS	RE	Geometry
Corner Angle 0° 	TPEN1603PPR	E	T	●				●			9.525	3.18	1.2	—	
	TPEN1603PPN	E	T *1						●		9.525	3.18	1.2	—	
	TPEN2204PDR	E	T *1	●				●	●	●	12.7	4.76	1.4	—	
	TPEN2204PDL	E	T *1						□		12.7	4.76	1.4	—	
PMF 	TPEW1303ZPER2	E	E	●	●						7.94	3.18	2	—	
11° Positive 	TPMN160304	M	E *1	●	★	★		●	●	●	9.525	3.18	—	0.4	
	TPMN160308	M	E *2	●	★	●		●	●	●	9.525	3.18	—	0.8	
	TPMN160312	M	E *1			●				★	9.525	3.18	—	1.2	
	TPMN220404	M	E						●		12.7	4.76	—	0.4	
	TPMN220408	M	E *1	●	★	●			●	●	12.7	4.76	—	0.8	
	TPMN220408T	M	T					●			12.7	4.76	—	0.8	
	TPMN220412	M	E *1	★	★				●	●	12.7	4.76	—	1.2	
Corner Angle 0° 	TPNN2204PDR	N	E						●		12.7	4.76	1.4	—	

*1 Grade HT110 is "F".









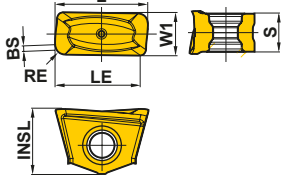

*2 Grade HT110 is "F", Grade NX2525 is "T".

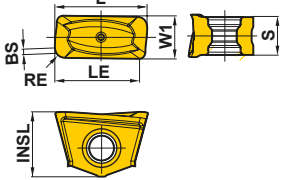
ROTATING INSERTS

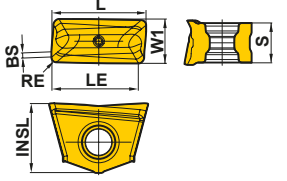

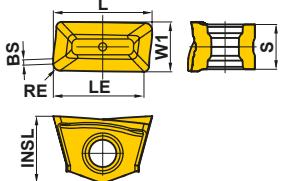
Work Material	P	Steel									Cutting Conditions (Guide): ●: Stable Cutting ●: General Cutting ✖: Unstable Cutting Honing: E: Round F: Sharp		
	M	Stainless Steel											
	K	Cast Iron											
Shape	N	Non-ferrous Metal	✖	✖							Dimensions (mm) L LE S BS RE Geometry		
	S	Heat-resistant Alloy, Titanium Alloy	●										
	H	Hardened Materials											
Order Number	Class	Honing	Coated		Carbide		Dimensions (mm)						
			MP9120	LC15TF	NEW MT2010	TF15	L	LE	S	BS	RE		
AXD4000 ⓈK155 AXD4000A ⓈK162	XDGX175004PDFR-GL	G	F	★			●	23.0	16.9	5	1.7	0.4	
	XDGX175008PDFR-GL	G	F	★			●	23.0	17.0	5	1.3	0.8	
	XDGX175012PDFR-GL	G	F	★			●	23.0	17.0	5	0.9	1.2	
	XDGX175016PDFR-GL	G	F	★			●	22.0	16.4	5	1.4	1.6	
	XDGX175020PDFR-GL	G	F	★			●	22.0	16.4	5	1.0	2.0	
	XDGX175024PDFR-GL	G	F	★			●	22.0	16.4	5	0.6	2.4	
	XDGX175030PDFR-GL	G	F	★			●	21.1	16.1	5	0.8	3.0	
	XDGX175032PDFR-GL	G	F	★			●	21.1	16.1	5	0.6	3.2	
	XDGX175040PDFR-GL	G	F	★			●	20.0	15.6	5	0.8	4.0	
XDGX175050PDFR-GL	G	F	★			●	19.4	15.3	5	0.4	5.0		
AXD4000 ⓈK155 AXD4000A ⓈK162	XDGX175004PDER-GM	G	E	●				23.0	17.0	5	1.7	0.4	
	XDGX175008PDER-GM	G	E	●				23.0	17.0	5	1.2	0.8	
	XDGX175012PDER-GM	G	E	●				23.0	17.0	5	0.9	1.2	
	XDGX175016PDER-GM	G	E	●				22.0	15.9	5	1.3	1.6	
	XDGX175020PDER-GM	G	E	●				22.0	15.9	5	0.8	2.0	
	XDGX175024PDER-GM	G	E	●				22.0	15.9	5	0.4	2.4	
	XDGX175030PDER-GM	G	E	●				21.1	16.0	5	0.6	3.0	
	XDGX175032PDER-GM	G	E	●				21.1	16.0	5	0.4	3.2	
	XDGX175040PDER-GM	G	E	●				20.0	14.8	5	0.5	4.0	
XDGX175050PDER-GM	G	E	●				19.4	15.0	5	0.3	5.0		
AXD4000 ⓈK155 AXD4000A ⓈK162	XDGX175004PDFR-GM	G	F			●	●	23.0	17.0	5	1.7	0.4	
	XDGX175008PDFR-GM	G	F			●	●	23.0	17.0	5	1.2	0.8	
	XDGX175012PDFR-GM	G	F			★	●	23.0	17.0	5	0.9	1.2	
	XDGX175016PDFR-GM	G	F			●	●	22.0	15.9	5	1.3	1.6	
	XDGX175020PDFR-GM	G	F			●	●	22.0	15.9	5	0.8	2.0	
	XDGX175024PDFR-GM	G	F			★	●	22.0	15.9	5	0.4	2.4	
	XDGX175030PDFR-GM	G	F			●	●	21.1	16.0	5	0.6	3.0	
	XDGX175032PDFR-GM	G	F			●	●	21.1	16.0	5	0.4	3.2	
	XDGX175040PDFR-GM	G	F			●	●	20.0	14.8	5	0.5	4.0	
XDGX175050PDFR-GM	G	F			★	●	19.4	15.0	5	0.3	5.0		
AXD7000 ⓈK166	XDGX227008PDFR-GL	G	F	★			●	30.0	21.6	7	2.0	0.8	
	XDGX227016PDFR-GL	G	F	★			●	30.0	21.7	7	1.2	1.6	
	XDGX227020PDFR-GL	G	F	★			●	30.0	21.7	7	0.8	2.0	
	XDGX227030PDFR-GL	G	F	★			●	28.8	21.2	7	0.8	3.0	
	XDGX227032PDFR-GL	G	F	★			●	28.8	21.2	7	0.6	3.2	
	XDGX227040PDFR-GL	G	F	★			●	27.5	20.6	7	0.9	4.0	
	XDGX227050PDFR-GL	G	F	★			●	27.0	20.3	7	0.4	5.0	

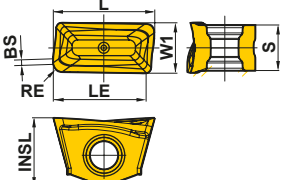
● ★ = NEW

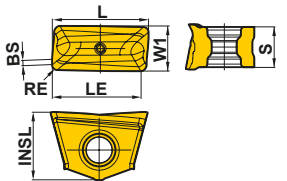
● : Inventory maintained. ★ : Inventory maintained in Japan.
 (10 inserts in one case)

Work Material	P	Steel	Class	Honing	Coated	Cutting Conditions (Guide):							Geometry
	M	Stainless Steel				●:Stable Cutting ●:General Cutting ✦:Unstable Cutting Honing: E:Round							
Shape	Order Number	MP9130	L	LE	W1	INSL	S	BS	RE	RE	RE	RE	
													K
Shape	Order Number	MP9130	L	LE	W1	INSL	S	BS	RE	RE	RE	RE	
													N
Shape	Order Number	MP9130	L	LE	W1	INSL	S	BS	RE	RE	RE	RE	
													S
Shape	Order Number	MP9130	L	LE	W1	INSL	S	BS	RE	RE	RE	RE	
													H
	VFX5 K192	XNMU160708R-MS	M	E	●	16.0	13.4	7.0	11.1	6.5	1.0	0.8	
		XNMU160712R-MS	M	E	●	16.0	13.8	7.0	11.1	6.5	1.0	1.2	
		XNMU160716R-MS	M	E	●	16.0	13.8	7.0	11.1	6.5	1.0	1.6	
		XNMU160724R-MS	M	E	●	16.0	13.8	7.0	11.1	6.5	1.0	2.4	
		XNMU160732R-MS	M	E	●	17.3	14.4	7.0	11.1	6.5	—	3.2	
		XNMU160740R-MS	M	E	●	18.9	15.2	7.0	11.1	6.5	—	4.0	
	VFX5 K192	XNMU160708R-HS	M	E	●	16.0	13.4	7.0	11.1	6.5	1.0	0.8	
	VFX5 K192	XNMU160708R-LS	M	E	●	16.0	13.4	7.0	11.1	6.5	1.0	0.8	
	VFX6 K196	XNMU190912R-MS	M	E	●	19.1	16.5	9.5	12.7	8.5	1.0	1.2	
		XNMU190916R-MS	M	E	●	19.1	16.5	9.5	12.7	8.5	1.0	1.6	
		XNMU190924R-MS	M	E	●	19.1	16.6	9.5	12.7	8.5	1.0	2.4	
		XNMU190932R-MS	M	E	●	20.2	17.1	9.5	12.7	8.5	—	3.2	
		XNMU190940R-MS	M	E	●	21.8	17.8	9.5	12.7	8.5	—	4.0	
		XNMU190950R-MS	M	E	●	21.8	17.8	9.5	12.7	8.5	—	5.0	
	VFX6 K196	XNMU190912R-HS	M	E	●	19.1	16.5	9.5	12.7	8.5	1.0	1.2	
	VFX6 K196	XNMU190912R-LS	M	E	●	19.1	16.5	9.5	12.7	8.5	1.0	1.2	

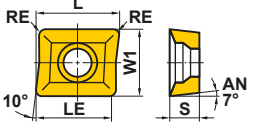
ROTATING INSERTS

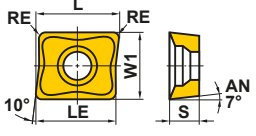





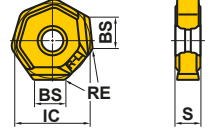
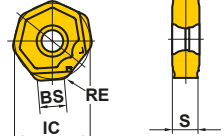

Work Material	P	Steel	●	●	●		●					Cutting Conditions (Guide): ●: Stable Cutting ●: General Cutting ✖: Unstable Cutting Honing: E: Round	
	M	Stainless Steel	●	●	●		●						
Work Material	K	Cast Iron	✖	✖			✖						
	N	Non-ferrous Metal											
	S	Heat-resistant Alloy, Titanium Alloy	●										
H	Hardened Materials		●										
Shape	Order Number	Class	Honing	Coated			Carbide	Dimensions (mm)					Geometry
				F7030	VP15TF	UP20M	UT20T	L	LE	W1	S	RE	
DCCC ↻K200 	ZCMX083508ER-A	M	E	●			★	11	8.5	7.94	3.5	0.8	
	ZCMX09T308ER-A	M	E	●	●	●	★	12.7	11	9.525	3.97	0.8	
DCCC ↻K200 	ZCMX09T308ER-B	M	E	●	★			12.7	11	9.525	3.97	0.8	

ROTATING INSERTS

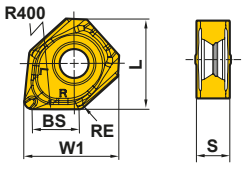
● : Inventory maintained. ★ : Inventory maintained in Japan.
 (10 inserts in one case)

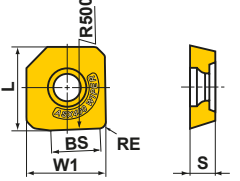
WIPER INSERTS

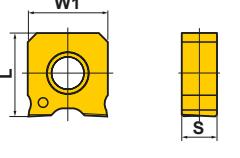

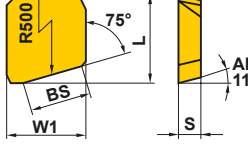







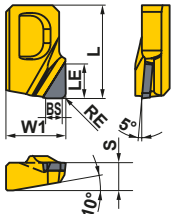

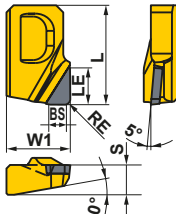
ROTATING INSERTS

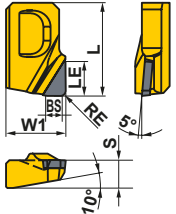
Work Material	P	Steel	●	●	●	●	●	Cutting Conditions (Guide): ●: Stable Cutting ●: General Cutting ✖: Unstable Cutting									
	M	Stainless Steel	●	●	●	●	●	Honing: E: Round T: Chamfer									
	K	Cast Iron	●	●	●	●	●										
N	Non-ferrous Metal	●	●	●	●	●											
S	Heat-resistant Alloy, Titanium Alloy	●	●	●	●	●											
H	Hardened Materials	●	●	●	●	●											
Shape	Order Number	Class	Honing	Coated			Cermet		Carbide		Dimensions (mm)						Geometry
				MC5020	MP6120	VP15TF	NX2525	MX3020	HT105T	L	W1	IC	S	BS	RE		
AHX640S ↻K041 AHX640W ↻K048 	WNEU2006ZEN7C-WK	E	E	●							-	-	20	6.55	7.4	0.8	
	WNEU2007ZEN7C-WP	E	E		●						-	-	20	6.9	7.1	0.8	
WSX445 ↻K016 	WNGU1406ANEN8C-M	G	E	●	●	●	●				16.87	16.87	-	6	8	1.0	
ASX400 ↻K068 	WOEW12T308PEER8C	E	E					●			13.2	12.5	-	3.97	8	0.8	
	WOEW12T308PETR8C	E	T					●			13.2	12.5	-	3.97	8	0.8	
VOX400 ↻K065 	WOEX1206PER5C	E	E		●						13.025	12.5	-	5.5	-	-	
FBP415 	WPC42EEER10C	C	E					●			15.163	12.5	-	3.175	10	-	

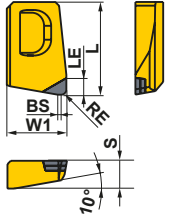
Right hand insert shown.

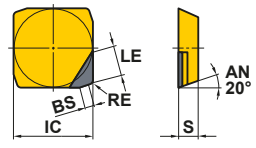
● : Inventory maintained. ★ : Inventory maintained in Japan.
(10 inserts in one case)

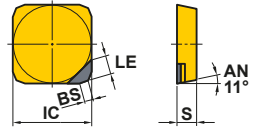
CBN AND PCD

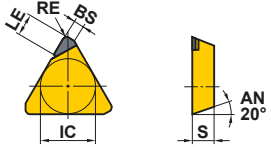
Work Material	K Cast Iron		● ●		Cutting Conditions (Guide):								Geometry
	N Non-ferrous Metal		● ●		●: Stable Cutting ●: General Cutting ✦: Unstable Cutting								
Shape	Order Number	Class	CBN		PCD		Dimensions (mm)						Geometry
			NEW MB4120 MB710		MD2030 MD220		L	LE	W1	IC	S	BS	
	GOER1404PXFR2	E			● ●	14.0	5.0	9.0	—	4.2	2.0	0.4	
	GOER1408PXFR2	E			● ●	14.0	5.0	9.0	—	4.2	2.0	0.8	
	GOER1408PXFR2-8	E			★	14.0	8.0	9.0	—	4.2	2.0	0.8	
	GOER1401ZXFR2	E			●	14.0	5.0	9.0	—	4.2	2.0	0.1	
	NP-GOEN1404PXSR05	E	●			14.0	2.5	9.0	—	4.2	0.5	0.4	
	NP-GOEN1408PXSR05	E	●			14.0	2.5	9.0	—	4.2	0.5	0.8	
	SECN1203EFFR1	C			★	—	5.0	—	12.7	3.18	1.4	1.0	
	SPEN1203EETR1	E	★			—	3.0	—	12.7	3.175	1.4	—	
	TECN1603PEFR1	C			★	—	5.0	—	9.525	3.175	1.4	0.4	



● ★ = NEW

● : Inventory maintained. ★ : Inventory maintained in Japan.
(1 insert in one case)

ROTATING INSERTS

ROTATING TOOL INSERTS

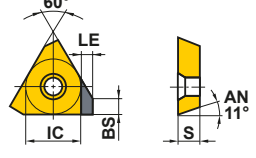
CBN AND PCD WITH WIPER

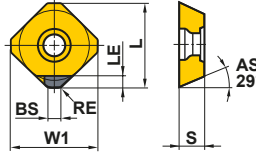
Work Material	K	Cast Iron	●	●	Cutting Conditions (Guide):							Geometry
	N	Non-ferrous Metal			●	●	✦	✦	✦	✦	✦	
Shape	Order Number	Class	CBN	PCD	Dimensions (mm)						Geometry	
			MB710	MD220	L	LE	W1	IC	S	BS		RE
	TPEW1303ZPTR2	E	●		—	1.5	—	7.94	3.18	2	—	
	WEEW13T3AGFR3C	E		●	16.6	1.8	16.48	—	3.97	3.0	1.5	
	WEEW13T3AGTR3C	E	●		16.6	1.8	16.48	—	3.97	3.0	1.5	

ROTATING INSERTS

L

● : Inventory maintained. ★ : Inventory maintained in Japan.
 (1 insert in one case)

Memo

A series of horizontal dashed lines for writing, spanning the width of the page.

Memo

A series of horizontal dashed lines for writing, spanning the width of the page.

SPARE PARTS

IDENTIFICATION	N002
SPARE PARTS	
CLAMP SCREW	N003
SET BOLT	N009
ADJUSTMENT SCREW / NUT	N010
SHIM	N011
SHIM PIN AND CLAMP LEVER	N014
LOCK PIN	N015
CLAMP BRIDGE	N015
BREAKER PIECE	N017
ANTI SEIZE LUBRICANT	N018



IDENTIFICATION

IDENTIFICATION OF CLAMP SCREW (Metric coarse right hand screw thread)

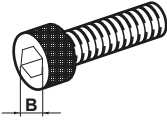

H SC 060 05

Length

Example	
Symbol	L
05	5
10	10
20	20
30	30

Screw Diameter

Example	
Symbol	d
050	M5
060	M6

Hexagonal Hole Dimensions

Diameter	Pitch	B Dimensions			
		HBH	HFC	HSC	HS \odot
M2	0.4	—	—	1.5	0.9
M2.5	0.45	—	—	2	1.3
M3	0.5	2	2	2.5	1.5
M4	0.7	2.5	2.5	3	2
M5	0.8	3	3	4	2.5
M6	1	4	4	5	3
M8	1.25	5	5	6	4
M10	1.5	6	6	8	5

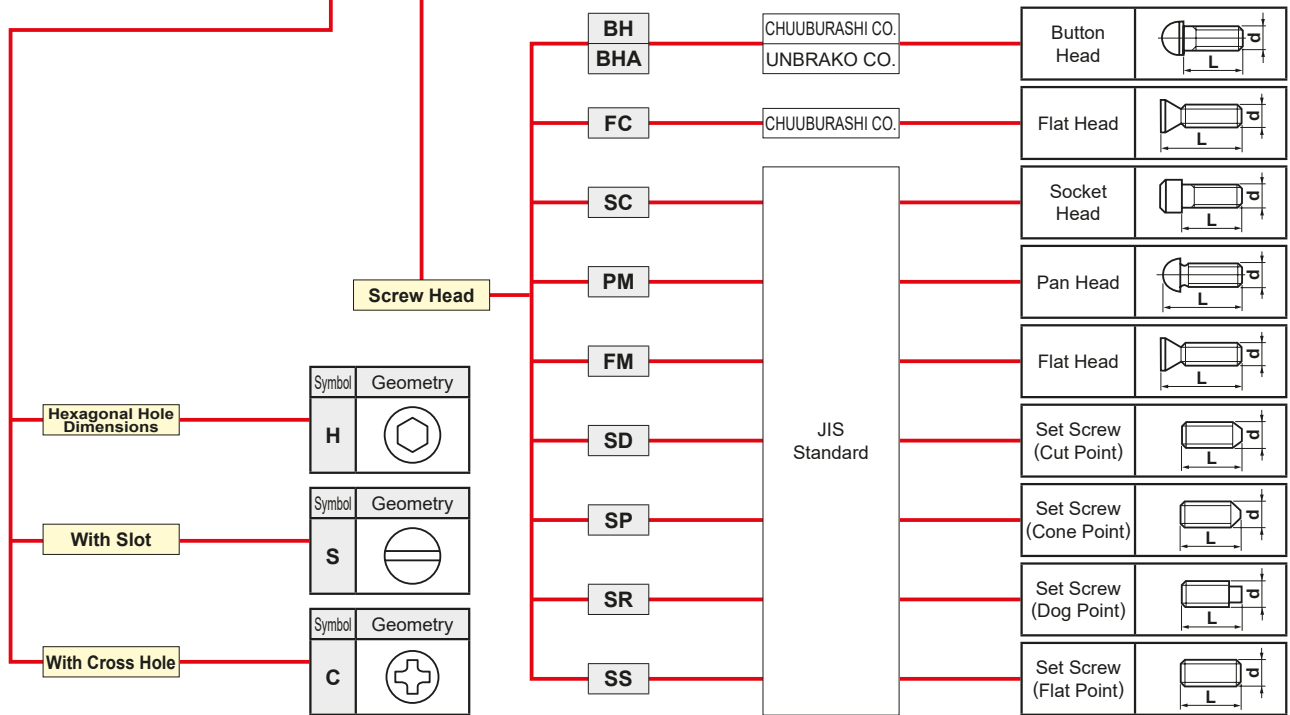

Hexagonal Hole Dimensions

Symbol	Geometry
H	

With Slot

Symbol	Geometry
S	

With Cross Hole

Symbol	Geometry
C	

IDENTIFICATION OF WRENCH

HKY 15 R

Symbol	Wrench
HKY	Hexagonal Wrench
TKY	Torx Wrench
RKY	R Wrench
TIP	Torx plus Wrench

Hexagonal Wrench	
Symbol	B
15	1.5
20	2
25	2.5
30	3
35	3.5
40	4
50	5
60	6

Torx Wrench		
Symbol	B	Size
06	1.7	T6
08	2.3	T8
10	2.7	T10
15	3.3	T15
20	3.8	T20
25	4.4	T25
27	5.0	T27
30	5.5	T30

Torx plus Wrench		
Symbol	B	Size
06	1.8	6IP
07	2.1	7IP
08	2.4	8IP
10	2.8	10IP
15	3.4	15IP

R	Standard L Wrench	
L	Long L Wrench	
T	T Wrench	
F	Flag Wrench	
FS	Flag Wrench	
W	Flag Wrench	
D	Driver	
DS	Driver	
S	Wrench	

IMX 10 - WR

Symbol	Wrench
IMX	Wrench for iMX Series

Hexagonal Wrench	
Symbol	B
10	8
12	10
16	13
20	16
25	20

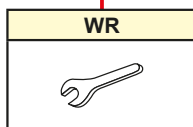

SPARE PARTS

CLAMP SCREW

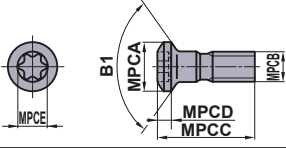
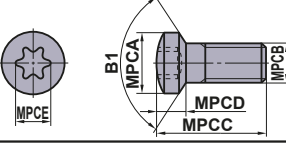
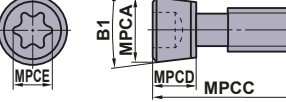
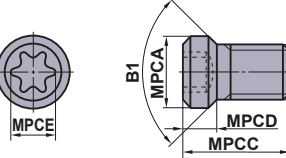
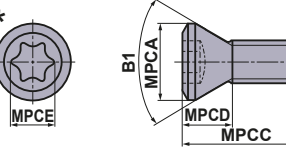
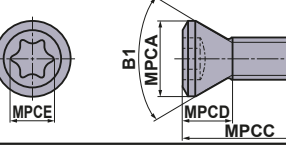
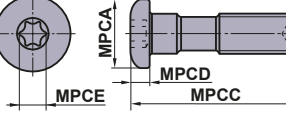
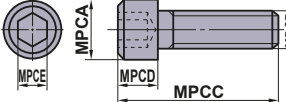

Geometry	Order Number	Dimensions (mm)					Angle	MPCDS	TQ (N·m)	Tool Holder
		MPCA	MPCB	MPCC	MPCD	MPCE				
	AJS3010T10	5	M3×0.5	10	1.5	2.8	120°	T10	2.5	Profile Holder (⊕C032) AJX (⊕K180) AJX (⊕K180)
	AJS4012T15	7	M4×0.7	12	2.2	3.4	120°	T15	3.5	
	AJS5014T25	8	M5×0.8	14	2.7	4.5	120°	T25	7.5	
	BRS103	5	M3×0.5	9.9	2.9	3.4	120°	T15	3.5	
	BRS105	8	M5×0.8	13.8	3.8	4.5	120°	T25	7.5	
	CAS51T	7.9	M5×0.8	19	5	4.5	10°	T25	8.5	
 	CS200T	3.2	M2×0.4	5	1.6	1.8	90°	T6	0.6	F Type Boring Bar (⊕E027)
	CS250T	3.7	M2.5×0.45	6	1.8	2.4	90°	T8	1.0	Milling Tools Series (⊕K001)
	* CS250560T	3.9	M2.5×0.45	5.2	2.5	2.4	60°	T8	1.0	BRP (⊕K190)
	CS300590T	4.1	M3×0.5	5.5	2.1	2.4	90°	T8	1.0	DCCC (⊕K200)
	CS300790TS	4.7	M3×0.5	7	2.3	2.8	90°	T10	2.0	
	CS300890T	4.1	M3×0.5	8	2.1	2.4	90°	T8	1.0	
	CS350690T	4.8	M3.5×0.6	6.5	2.4	2.8	90°	T10	2.5	MMTI Type Boring Bar (⊕G026) BRP (⊕K190)
	* CS350760T	5.5	M3.5×0.6	7	4.0	3.4	60°	T15	3.5	
	CS350790T	4.8	M3.5×0.6	7	2.4	2.8	90°	T10	3.5	
	* CS350860T	5.5	M3.5×0.6	8.4	4.0	3.4	60°	T15	3.5	DCCC (⊕K200)
	CS350990T	4.8	M3.5×0.6	9	2.4	2.8	90°	T10	2.5	AL Type Holder (⊕C034)
	CS400990T	6.0	M4×0.7	9	2.8	3.4	90°	T15	3.5	
	CS401160T	5.7	M4×0.7	11	4.5	3.4	60°	T15	3.5	
	CS401990T	6.0	M4×0.7	19	3.0	3.9	90°	T20	3.5	AHX640S (⊕K041)
	CS451190T	6.3	M4.5×0.75	11	2.9	3.9	90°	T20	5.0	
* CS501160T	7.0	M5×0.8	11	3.6	3.9	60°	T20	5.0		
CS501290T	7.0	M5×0.8	11	3.5	4.5	90°	T25	7.5	PMR (⊕K236)	
* CS5015060T	7.2	M5×0.8	15	2.4	3.9	60°	T20	5.0		
CS502190T	8.5	M5×0.8	21	4.0	5.1	90°	T27	7.5		
CS6016060T	8.5	M6×1.0	16	4.5	4.5	60°	T25	7.5		
	CSF401260T	7.2	M4×0.5	12	5.2	3.9	60°	T20	5.0	
	DC0520T	8.5	M5×0.8	22.5	2.5	3.4	—	T15	3.5	DOUBLE CLAMP Holder (⊕C008)
	DC0621T	10.5	M6×1.0	25	4	3.9	—	T20	5.0	DOUBLE CLAMP DIMPLE BAR (⊕E015) HSK Tool Holder (⊕H001)
	DKS4	5.6	M4×0.7	18	3.5	3	—	—	3.3	
DKS5	7.6	M5×0.8	19	4.5	4	—	—	7.0		

N

SPARE PARTS

SPARE PARTS

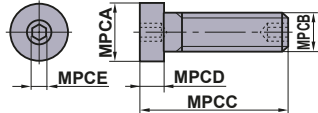
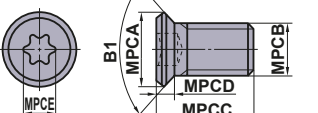
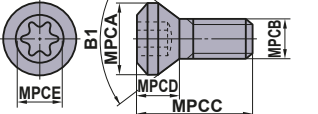
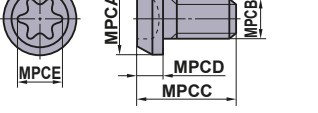
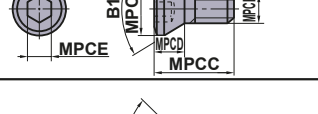
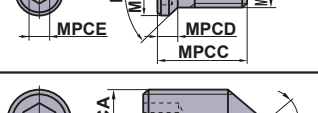
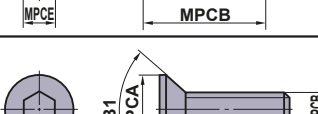
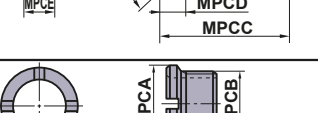
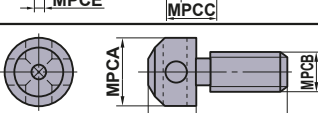
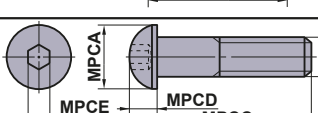
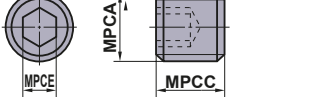
CLAMP SCREW

Geometry	Order Number	Dimensions (mm)					Angle		TQ (N·m)	Tool Holder
		MPCA	MPCB	MPCC	MPCD	MPCE	B1	MPCDS		
	EGS06019	9	M6×1	22.5	3.5	3	—	—	3.3	
	EGS08024	11	M8×1.25	28.5	4.5	4	—	—	7.0	
	FC400890T	5.6	M4×0.7	7.5	1.3	2.8	90°	T10	2.5	AL Type Holder (☉C035) AL Type Boring Bar (☉E041)
	GY05016S	8.7	M5×0.8	16	3.5	3.9	90°	T20	5.0	GY Series (☉F004)
	GY06013M	12	M6×1	18	5	5.6	—	T30	6.0	GY Series (☉F004)
	HFF06015	10	M6×1	15	6	5	80°	—	8.2	
	HS4L	5.4	M4×0.7	14	2.3	2.5	80°	—	3.8	
	HS5S	6.8	M5×0.8	9	2.8	3	80°	—	3.3	
	HS5L	6.8	M5×0.8	15	2.8	3	80°	—	6.6	
	HSP05008C	M5×0.8	8	—	—	2.5	—	—	2.5	MP Type Holder (☉C019)
	HY-A1	4.4	M3×0.5	7	2.1	2	82°	—	1.5	
	HY-V1	5.5	M3×0.5	7	2.5	2	82°	—	1.5	
	HY2	5.5	M3×0.5	10	2.5	2	82°	—	1.5	
	HY3	7	M3.5×0.6	12	2.9	2	82°	—	1.5	
	HY4	9.3	M5×0.8	16	3.6	3	82°	—	3.3	
	JSS6	6.9	M6×0.75	4.5	1.5	0.8	—	—	—	
	JSS7	8	M7×0.75	4.4	1.5	1	—	—	—	
	KS1	7	M4×0.7	14	5	—	—	—	—	
	KS2	10	M6×1	18	7	—	—	—	—	
	KS2S	10	M6×1	18	7	—	—	—	—	
	KS12	10	M6×1	26	4	4	—	—	7.0	
	LLR1	M5×0.8	—	3.5	—	2.5	—	—	—	
	LLR2	M6×1	—	5	—	3	—	—	—	

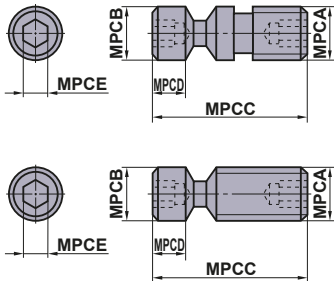
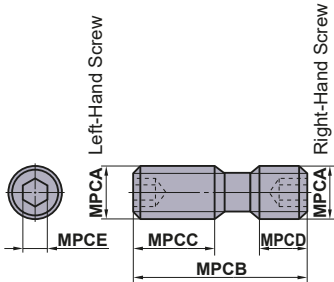
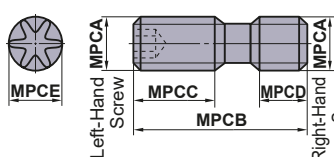
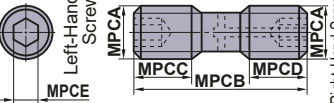
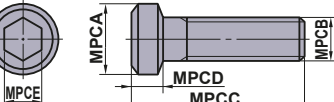
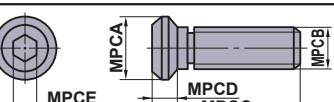
Geometry	Order Number	Dimensions (mm)					Angle B1	MPCOS	TQ (N·m)	Tool Holder
		MPCA	MPCB	MPCC	MPCD	MPCE				
 <p>LLCS103, LLCS105 LLCS112, LLCS125 LLCS205</p> <p>The products with "*" do not have a hexagonal hole at the end marked MPCB. The products with "☆" do not have a hexagonal hole at the end marked MPCA.</p>	☆ LLCS103	M3×0.5	4	11	4.6	2	—	—	1.5	P Type Boring Bar (E037) HSK Tool Holder (H001)
	* LLCS105	M5×0.8	M5×0.8	10	1.5	2	—	—	1.5	
	LLCS106	M6×1	6	16.5	3.5	2.5	—	—	2.2	
	* LLCS106S	M6×1	6	13.4	0.7	2.5	—	—	2.2	
	LLCS108	M8×1.25	8	21	6.5	3	—	—	3.3	
	* LLCS108S	M8×1.25	8	16.5	2	3	—	—	3.3	
	LLCS110	M10×1.5	10	29	8	4	—	—	7.0	
	LLCS112	M12×1	11.9	36.2	9	5	—	—	8.0	
	LLCS125	M5×0.8	M5×0.8	12	2	2	—	—	1.5	
	LLCS205	M5×0.8	M5×0.8	16	4	2	—	—	1.5	
	LLCS206	M6×1	6	26	13	2.5	—	—	2.2	
	LLCS208	M8×1.25	8	24	6.5	3	—	—	3.3	
	LLCS306	M6×1	6	21	4	2.5	—	—	2.2	
	LLCS308	M8×1.25	8	42	27.5	3	—	—	3.3	
	LLCS310	M10×1	10	29	8	4	—	—	7.0	
LLCS410	M10×1	10	30	6.6	4	—	—	7.0		
LLCS508	M8×1	8	24	6.5	3	—	—	3.3		
* LLCS508S	M8×1	8	20.5	3	3	—	—	3.3		
 <p>Left-Hand Screw Right-Hand Screw</p> <p>*Without Hexagonal Hole on Right-Hand Screw</p>	LS1	M6×1	22	8	8	3	—	—	5.0	Milling Tools Series (K001)
	LS2	M8×1	29	13	10	4	—	—	8.2	
	LS3	M8×1	32	13	13	4	—	—	8.2	
	* LS4	M6×1	15	8	4	3	—	—	5.0	
	* LS5	M6×1	18	8	5	3	—	—	5.0	
	* LS6	M8×1	24	13	5	4	—	—	8.2	
	* LS7	M8×1	27	13	8	4	—	—	8.2	
	* LS8	M6×0.75	18	7	7	3	—	—	5.0	
	* LS9	M6×0.75	22	8	8	3	—	—	5.0	
	* LS10	M7×0.75	16	6	6	4	—	—	8.2	
	* LS11	M8×1	16	6	6	4	—	—	7.8	
	* LS12	M8×1	24	7	7	4	—	—	7.8	
	* LS13	M8×1	34	12	12	4	—	—	7.8	
	* LS14	M7×0.75	24	10	10	4	—	—	7.8	
	* LS16	M7×0.75	23	11	8	4	—	—	7.8	
* LS18	M7×0.75	14	6	4	4	—	—	7.8		
* LS20	M10×1.5	26	9	9	5	—	—	9.0		
* LS21	M10×1.5	32	12	12	5	—	—	9.0		
LS24	M8×1.25	24	8.5	8.5	4	—	—	7.8		
LS25	M8×1	28.5	12.0	10.5	4	—	—	8.2		
 <p>Left-Hand Screw Right-Hand Screw</p>	LS10T	M7×0.75	14	6	5	4.5	—	T25	8.0	DOUBLE CLAMP Holder (C009) AHX640W (K048)
	LS14T	M7×0.75	24	10	10	4.5	—	T25	8.0	
	LS15T	M7×0.75	18	7	7	4.5	—	T25	8.0	
	LS19T	M6×0.75	11	4	4	3.4	—	T15	5.0	
	LS10TS	M7×0.75	13	6	4	4.5	—	T25	8.5	
	LS0622T	M6×0.75	22	8	8	3.4	—	T15	6.0	
 <p>Left-Hand Screw Right-Hand Screw</p>	LS24H	M8×1.25	24	8.5	8.5	4	—	—	8.2	
	MGS6	10	M6×1	26	4	5	—	—	9.0	APX3000 (K133)
	MHT1	11	M8×1	18.5	3.5	4	—	—	8.7	

SPARE PARTS

CLAMP SCREW

Geometry	Order Number	Dimensions (mm)					Angle	MPCDS	TQ (N·m)	Tool Holder
		MPCA	MPCB	MPC	MPCD	MPCCE				
	NS251	3.6	M2.5×0.45	7	—	2.2	60°	—	0.7	BTVH (⊕D016) CSVH (⊕D027) CTAH-S (⊕D020)
	NS401	5.8	M4×0.7	6	—	3.6	60°	—	3.5	
	NS402W	5.85	M4×0.7	10	—	2.2	60°	—	0.7	CTAH (⊕D020) CTBH (⊕D022)
	NS403W	5.85	M4×0.7	12	—	2.2	60°	—	0.7	
	NS404W	5.8	M4×0.7	10	—	2.2	90°	—	0.7	
	NS501W	8	M5×0.8	16	—	2.5	120°	—	2.2	SMALL TOOLS (⊕D001)
	NS502W	8	M5×0.8	20	—	2.5	120°	—	2.2	
	RN-S6	9.5	M6×0.75	20.3	4.6	3.9	61°	T20	5.0	
	RN-S7	11	M7×0.75	24.7	5.2	4.5	61°	T25	7.5	
	RS3008T	4.3	M3×0.35	8.6	2	2.4	61°	T8	1.5	SRF (⊕K212) SUF (⊕K216)
	RS3510T	5	M3.5×0.35	10	2.3	2.8	61°	T10	2.5	
	RS4015T	6	M4×0.5	14	2.7	3.4	61°	T15	3.3	
	RS5020T	8.1	M5×0.5	16.4	3.6	3.9	61°	T20	5.0	
	RS6025T	9.5	M6×0.75	21.5	4.2	4.5	61°	T25	7.5	
	RS8030T	12	M8×0.75	25	5	5.6	61°	T30	10.0	
	S1	3.5	M2×0.4	5.5	2.2	1.5	92°	—	0.6	
	S3	4.5	M3×0.5	7.7	2.4	2	92°	—	1.5	
	S4	5.3	M4×0.7	8	1.8	2.5	62°	—	2.2	
	S5	6.8	M5×0.8	9	2.4	3	62°	—	3.3	
	SD32	12	M8×1.25	28	7.2	6	50°	—	9.5	
	SD40	12	M8×1.25	36	7.2	6	50°	—	9.5	
	SD50	16	M10×1.5	46	8.2	8	50°	—	1.0	
	SD63	16	M10×1.5	61	8.2	8	50°	—	1.0	
	SETS51	6.8	M5×0.8	14.8	1.5	3.4	—	T15	3.5	MMTE Type Holder (⊕G019) MMTI Type Boring Bar (⊕G026) HSK Tool Holder (⊕H001)
	SETS61	8	M6×1	20	1.8	3.9	—	T20	5.0	
	SLCS105	10	M5×0.8	25	6.3	4	90°	—	7.0	WP Type Holder (⊕C017)
	SLCS106	12	M6×1	32	6.2	4	90°	—	7.0	
	SPS1	8.5	M5×0.8	16	4	4.5	70°	T25	5.0	
	SRS5	6.7	M5×0.8	16	3.5	3.9	—	T20	5.0	
	STS1	6.8	M3×0.5	7	2.2	2.8	90°	T10	2.5	

Geometry	Order Number	Dimensions (mm)					Angle	MPCDS	TQ (N·m)	Tool Holder
		MPCA	MPCB	MPCC	MPCD	MPCE				
	* TS16	2.5	M1.6×0.35	3.2	1.6	1.8	60°	T6	0.6	MICRO-DEX (☉E018)
	TS2	2.7	M2×0.4	4.6	1.4	1.8	60°	T6	0.6	
	* TS2A	2.7	M2×0.4	4.5	1.2	1.8	60°	T6	0.6	AQX (☉K172)
	TS2C	2.7	M2×0.4	3.8	1.4	1.8	60°	T6	0.6	
	☆ TS2D	3.8	M2×0.4	5.3	1.9	1.8	82°	T6	0.6	DIMPLE BAR (☉E007)
	TS21	2.7	M2×0.4	3.4	1.4	1.8	60°	T6	0.6	F Type Boring Bar (☉E029)
	* TS22	3.0	M2.2×0.45	5	1.2	1.8	60°	T6	0.6	S Type Boring Bar (☉E030)
	* TS25	3.3	M2.5×0.45	5.5	1.7	2.4	60°	T8	1.0	AQX (☉K172) AJX (☉K180)
	☆ TS25D	4.4	M2.5×0.45	6.2	2.2	2.4	82°	T8	1.0	MMTI Type Boring Bar (☉G026)
	* TS25H	3.6	M2.5×0.45	5.5	2	2.4	60°	T8	1.0	SRM2 (☉K220)
	TS202	2.7	M2×0.4	5.5	1.8	1.8	60°	T6	0.6	
	TS253	3.3	M2.5×0.45	4.5	1.7	2.4	60°	T8	1.0	Milling Tools Series (☉K001)
	TS254	3.3	M2.5×0.45	7	1.7	2.4	60°	T8	1.0	SMALL TOOLS (☉D001) PMF (☉K234)
	* TS255	3.5	M2.5×0.45	7.5	1.6	2.4	60°	T8	1.0	Profile Holder (☉C032)
	TS3	3.9	M3×0.5	6	2	2.4	60°	T8	1.0	TSMP (☉K232)
	TS304	3.9	M3×0.5	10.5	2.0	2.4	60°	T8	1.5	
	TS3D	5.0	M3×0.5	6	2.3	2.8	82°	T10	2.5	DIMPLE BAR (☉E007)
	* TS3SB	4.4	M3×0.5	8	2	2.4	80°	T8	1.5	AXD4000 (☉K155)
	TS3SBS	4.4	M3×0.5	6.5	2	2.4	80°	T8	1.5	AXD4000 (☉K155)
	☆ TS31D	4.8	M3×0.5	7.2	2.2	2.8	82°	T10	2.5	DIMPLE BAR (☉E007)
	* TS32	3.9	M3×0.5	7.5	2	2.4	60°	T8	2.0	SRM2 (☉K220)
	* TS33	3.9	M3×0.5	6.7	2	2.4	60°	T8	1.5	AQX (☉K172) AJX (☉K180)
	TS35	4.8	M3.5×0.6	6.5	2.4	2.8	60°	T10	2.5	
	* TS35D	5.3	M3.5×0.6	12	2.8	3.4	60°	T15	3.5	HSK Tool Holder (☉H001)
	★ TS35R	5.7	M3.5×0.6	10	2.1	3.4	—	T15	3.5	AHX440S (☉K034) AHX475S (☉K038)
	TS351	4.8	M3.5×0.6	7.2	2.4	2.8	60°	T10	2.5	AJX (☉K180) SRM2 (☉K220)
	TS352	4.8	M3.5×0.6	10	3	2.8	60°	T10	2.5	VFX5 (☉K192)
	* TS4S	5.4	M4×0.7	7	2.4	3.4	80°	T15	3.5	
	* TS4SL	5.4	M4×0.7	8	2.4	3.4	80°	T15	4.0	
	* TS4SB	5.8	M4×0.7	9	2.7	3.4	80°	T15	3.5	AXD7000 (☉K166)
	* TS4SBL	5.8	M4×0.7	10.5	2.7	3.4	80°	T15	3.5	GY SERIES (☉F004) AXD7000 (☉K166)
	TS4	5.4	M4×0.7	8	2.6	3.4	60°	T15	3.5	CE/CF/CGSP (☉K230) TSMP (☉K232)
	TS4D	5.6	M4×0.7	7.7	2.5	3.4	82°	T15	3.5	DIMPLE BAR (☉E007)
	TS42	5.4	M4×0.7	6	2.6	3.4	60°	T15	3.5	
	TS43	5.4	M4×0.7	10	2.6	3.4	60°	T15	3.5	AJX (☉K180) BRP (☉K190) SRM2 (☉K220)
	TS44	5.4	M4×0.7	12	2.6	3.4	60°	T15	3.5	
	TS406	5.4	M4×0.7	15.5	2.6	3.4	60°	T15	3.5	
	TS407	5.4	M4×0.7	9	2.6	3.4	60°	T15	3.5	AQX (☉K172) AJX (☉K180)
	TS450	5.9	M4.5×0.75	13	3.6	3.9	60°	T20	5.0	VFX6 (☉K196)
	TS5S	6.8	M5×0.8	9	2.9	4.5	80°	T25	7.5	
	* TS5SL	6.8	M5×0.8	12	2.9	4.5	80°	T25	7.5	
	TS5	6.8	M5×0.8	9	3.2	4.5	60°	T25	7.5	SP Holder (☉C024) CE/CF/CGSP (☉K230) TSMP (☉K232)
	TS5L	6.8	M5×0.8	15	2.9	4.5	80°	T25	7.5	
	★ TS5R	6.9	M5×0.8	12	3.5	3.9	—	T20	5.0	WWX400 (☉K056) WJX (☉K072)
	TS52	6.8	M5×0.8	8	3.2	4.5	60°	T25	7.5	CE/CF/CGSP (☉K230)
	TS53	6.8	M5×0.8	16	3.2	4.5	60°	T25	7.5	
	TS54	6.8	M5×0.8	12	3.2	4.5	60°	T25	7.5	AJX (☉K180)
	TS55	6.8	M5×0.8	10.5	3.2	4.5	60°	T25	7.5	GY SERIES (☉F004) AQX (☉K172) SPX (☉K203) SRM2 (☉K220)
	* TS6S	8.5	M6×1.0	13	4.4	5.6	60°	T30	10.0	AQX (☉K172) SRM2 (☉K220)
	* TS6	8.5	M6×1.0	16	4.4	5.6	60°	T30	10.0	SRM2 (☉K220)

SPARE PARTS

CLAMP SCREW

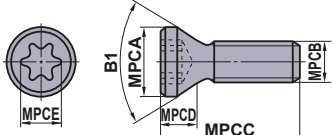
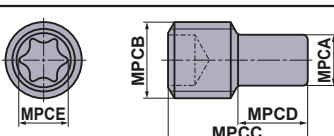
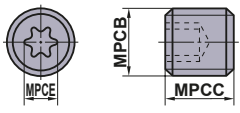
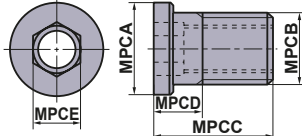
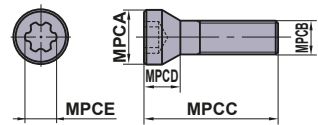
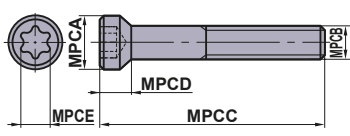
Geometry	Order Number	Dimensions (mm)					Angle B1	MPCDS	TQ (N·m)	Tool Holder
		MPCA	MPCB	MPCD	MPCD	MPCD				
	TPS20	2.7	M2×0.4	3.5	1.3	1.8	60°	6IP	0.5	
	TPS20-1	2.65	M2×0.4	4.7	2.4	1.8	60°	6IP	0.6	MVX (⊕M160)
	TPS22	3.0	M2.2×0.45	4.7	1.6	2.1	60°	7IP	0.5	
	TPS22S	3.0	M2.2×0.45	4.2	1.6	2.1	60°	7IP	0.5	
	TPS25	3.3	M2.5×0.45	5.5	1.7	2.1	60°	7IP	1.0	APX3000 (⊕K133) MVX (⊕M160)
	TPS25-1	3.3	M2.5×0.45	6.5	1.7	2.1	60°	7IP	1.0	APX3000 (⊕K133)
	TPS27F1	3.7	M2.7×0.35	6.5	1.8	2.1	60°	7IP	1.0	VPX200 (⊕K086)
	TPS27F2	3.7	M2.7×0.35	8.0	1.8	2.1	60°	7IP	1.0	VPX300 (⊕K100)
	TPS3	3.9	M3×0.5	6.7	1.4	2.82	60°	10IP	1.0	MVX (⊕M160)
	* TPS3R	4.6	M3×0.5	8.5	1.4	2.82	—	10IP	2.0	WJX09 (⊕K072)
	TPS3SB	4.4	M3×0.5	8	2.0	2.82	80°	10IP	3.0	AXD4000A (⊕K162)
	TPS35	5.3	M3.5×0.6	11.5	2.8	3.4	60°	15IP	3.5	ASX445 (⊕K026) ASX400 (⊕K068) PMR (⊕K236)
	TPS351	4.8	M3.5×0.6	7.2	1.4	2.82	60°	10IP	2.5	MVX (⊕M160)
	TPS351B	5.1	M3.5×0.6	7.2	1.4	2.82	60°	10IP	2.5	ARP (⊕K238)
	TPS4	5.3	M4×0.7	8	2.6	3.4	60°	15IP	3.5	APX4000 (⊕K140) ARP (⊕K238) MVX (⊕M160)
	TPS40F1	5.3	M4×0.5	10.5	2.8	3.4	60°	15IP	3.0	VPX300 (⊕K100)
TPS43	5.3	M4×0.7	10	2.6	3.4	60°	15IP	4.0	APX4000 (⊕K140) MVX (⊕M160)	
* TPS4R	6.4	M4×0.7	10.6	2.9	3.4	—	15IP	3.5	WSX445 (⊕K016)	
TPS54	6.8	M5×0.8	12	3.2	4.5	60°	25IP	7.5	MVX (⊕M160)	
	TSR05008S	3.5	M5×0.8	8	—	2.8	—	T10	—	
	TSR06011S	4	M6×1.0	11	—	3.9	—	T20	—	
	TSS04005	—	M4×0.7	5	—	2.4	—	T8	—	PMF (⊕K234)
	TSS04505S	—	M4.5×0.7	5	—	3.5	—	T10	3.5	FMAX (⊕K051)
	TSS05006	—	M5×0.8	6	—	2.8	—	T10	—	
	TSS06010	—	M6×1	10	—	3.9	—	T20	—	
	WCS503507H	6.3	M5×0.5	7	3.3	3.5	—	—	5.0	ASX445 (⊕K026) ASX400 (⊕K068) PMR (⊕K236)
	WCS604010H	7.8	M6×0.75	10	4.1	4.0	—	—	7.0	PMR (⊕K236)
	WS203107TPS	3.1	M2×0.25	7.3	1.7	1.8	60°	6IP	1.0	STAW (⊕M141)
	WS203108TPS	3.1	M2×0.25	8.3	1.9	1.8	60°	6IP	1.0	
	WS253909TPS	3.9	M2.5×0.35	9.5	2.4	2.4	60°	8IP	2.0	
	WS304912TPS	4.9	M3×0.35	12	3.25	2.82	60°	10IP	2.5	
	WS254012T	4	M2.5×0.45	11.5	2.2	2.4	80°	T8	2.0	TAW (⊕M150)
	WS254013T	4	M2.5×0.45	12.5	2.2	2.4	80°	T8	2.0	
	WS254014T	4	M2.5×0.45	13.5	2.2	2.4	80°	T8	2.0	
	WS254015T	4	M2.5×0.45	14.5	2.2	2.4	80°	T8	2.0	
	WS254016T	4	M2.5×0.45	15.5	2.2	2.4	80°	T8	2.0	
	WS304517T	4.5	M3×0.5	16.5	3.4	2.8	60°	T10	3.5	
	WS304518T	4.5	M3×0.5	17.5	3.4	2.8	60°	T10	3.5	
	WS355520T	5.5	M3.5×0.6	19.5	3.9	3.4	60°	T15	5.5	
	WS355521T	5.5	M3.5×0.6	20.5	3.9	3.4	60°	T15	5.5	
	WS406023T	6	M4×0.7	22.0	4.4	4.5	60°	T25	8.5	
	WS406024T	6	M4×0.7	23.0	4.4	4.5	60°	T25	8.5	
	WS508026T	8	M5×0.8	25.0	5.2	5.1	60°	T27	12.0	
	WS508027T	8	M5×0.8	26.0	5.2	5.1	60°	T27	12.0	

SPARE PARTS

N

SET BOLT

Geometry	Order Number	Dimensions (mm)					Angle	MPCDS	TQ (N·m)	Tool Holder
		MPCA	MPCB	MPCC	MPCD	MPCE				
	BOES101	15	M10×1.5	45	10	8	60°	—	10.0	
	* HSC08025H	13	M8×1.25	33	8	5	—	—	24	VPX200/300 (⊕K086,K100) ARP (⊕K238)
	HSC05030	8.5	M5×0.8	35	5	4	—	—	10	APX3000/4000 (⊕K133,K140)
	* HSC08030H	13	M8×1.25	38	8	5	—	—	24	WSX445 (⊕K016)
	HSC08045	13	M8×1.25	53	8	5	—	—	24	VPX200/300 (⊕K086,K100)
	HSC08040	13	M8×1.25	48	8	5	—	—	24	WSX445 (⊕K016)
	HSC08050	13	M8×1.25	58	8	5	—	—	24	VPX200/300 (⊕K086,K100)
	* HSC10030H	16	M10×1.5	40	10	6	—	—	40	APX3000/4000 (⊕K133,K140) AJX (⊕K180) WSX445 (⊕K016)
	HSC10035	16	M10×1.5	45	10	6	—	—	44	VFX5 (⊕K192) VFX6 (⊕K196)
	HSC10050	16	M10×1.5	60	10	8	—	—	44	APX3000/4000 (⊕K133,K140) VPX200/300 (⊕K086,K100)
	HSC10055	16	M10×1.5	65	10	8	—	—	44	VFX5 (⊕K192)
	HSC10060	16	M10×1.5	70	10	8	—	—	44	VPX200/300 (⊕K086,K100)
	HSC10070	16	M10×1.5	80	10	8	—	—	44	VPX200/300 (⊕K086,K100) ASPX (⊕K028)
	HSC12035	18	M12×1.75	47	12	10	—	—	80	WSX445 (⊕K016)
	* HSC12035H	18	M12×1.75	47	12	10	—	—	80	APX3000/4000 (⊕K133,K140) AJX (⊕K180)
	HSC12040	18	M12×1.75	52	12	10	—	—	80	
	HSC12045	18	M12×1.75	57	12	10	—	—	80	WSX445 (⊕K016)
	HSC12060	18	M12×1.75	72	12	10	—	—	80	VPX200/300 (⊕K086,K100)
	HSC12070	18	M12×1.75	82	12	10	—	—	80	APX3000/4000 (⊕K133,K140) AJX (⊕K180) WSX445 (⊕K016)
	HSC16040	24	M16×2	56	16	14	—	—	150	WSX445 (⊕K016)
	* HSC16040H	24	M16×2	56	16	14	—	—	150	APX3000/4000 (⊕K133,K140) AJX (⊕K180)
HSC16055	24	M16×2	71	16	14	—	—	150	VPX200/300 (⊕K086,K100)	
HSC16065	24	M16×2	81	16	14	—	—	150	VPX200/300 (⊕K086,K100)	
HSC16080	24	M16×2	96	16	14	—	—	150		
HSC20040	30	M20×2.5	60	20	17	—	—	320		
HSC20090	30	M20×2.5	110	20	17	—	—	320		
	HSCX12030H	24	M12×1.75	37	7	8	—	—	40	FMAX (⊕K051)
	HSCX16035H	30	M16×2	44	9	12	—	—	100	
	HSCX20035H	36	M20×2.5	46	11	14	—	—	180	
	HFF08033H	11	M8×1.25	33	5	5	90°	—	8.2	WJX09 (⊕K072)
	HFF08043H	11	M8×1.25	43	5	5	90°	—	8.2	AXD4000 (⊕K155)
	MBA16033H	40	M16×2	43	10	14	—	—	150	AHX640 (For φ100) (⊕K041) WSX445 (⊕K016)
	MBA20040H	50	M20×2.5	54	14	17	—	—	320	APX4000 (⊕K140) AHX475S (⊕K038) AHX640S (⊕K041) AXD4000 (⊕K155) AXD7000 (⊕K166) AJX (⊕K180)

* With coolant hole.

Geometry	Order Number	Dimensions (mm)						TQ (N·m)	Tool Holder
		MPCA	MPCB	MPCC	MPCD	MPCE	MPCF		
	HDS08030	M8×0.75	M8×1.25	30	13.5	11.5	4	8.2	BRP (⊕K190)
	HDS10031	M10×1.0	M10×1.5	31	14	12	5	9.0	PMF (⊕K234)

SPARE PARTS

LARGE ADJUSTMENT SCREW

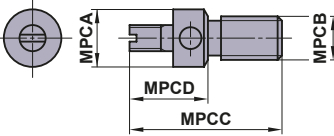
Geometry	Order Number	Dimensions (mm)					Angle	MPCDS	TQ (N·m)	Tool Holder
		MPCA	MPCB	MPCC	MPCD	MPCE	B1			
	KSS2	6.6	M5×0.8	17.5	9	—	—	—	FMAX (⊕K051)	

N

SPARE PARTS

MICRO ADJUSTMENT NUT

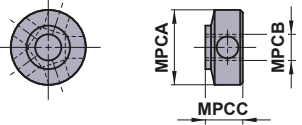
Geometry	Order Number	Dimensions (mm)					Angle	MPCDS	TQ (N·m)	Tool Holder
		MPCA	MPCB	MPCC	MPCD	MPCE	B1			
	KSN3	8.6	M3×0.35	4.3	—	—	—	—	FMAX (⊕K051)	

SHIM

Geometry	Order Number	Dimensions (mm)						Tool Holder
		MPCA	MPCB	MPCC	MPCD	MPCE	MPCF	
	CS32	9.52	3.18	0.8	0.8	1.2	1.2	
	CS42	12.70	3.18	0.8	0.8	1.2	1.6	
	CS43	12.70	4.76	0.8	0.8	1.2	1.6	
	* PS31	8.28	2.38	0.2	0.2	0.6	0.6	
	* PS42	11.46	3.18	0.2	0.2	0.6	1.0	
	CT22	6.35	3.18	0.4	0.8	1.2	—	F Type Boring Bar (E028)
	CT32	9.52	3.18	0.4	0.8	1.2	—	
	* PT21	5.11	2.38	0.2	0.2	0.6	—	
	* PT32	8.28	3.18	0.2	0.2	0.6	—	
	* PT42	10.85	3.18	0.3	0.3	0.7	—	
	DCSVN32	9.52	3.18	0.8	1.2	—	—	DOUBLE CLAMP Holder (C019) DOUBLE CLAMP DIMPLE BAR (E017)
	ESS42	12.70	3.18	0.8	0.8	1.2	1.6	
	EST32	9.52	3.18	0.4	0.8	1.2	—	
	EST43	12.70	4.76	0.4	0.8	1.2	—	
	LLSCN3T3	9.52	3.97	0.4	0.4	0.8	0.8	LL Type Holder (C008)
	LLSCN33	9.52	4.76	0.4	0.4	0.8	0.8	LL Type Holder (C008)
	LLSCN42	12.70	3.18	0.8	0.8	1.2	1.2	DOUBLE CLAMP DIMPLE BAR (E015)
	LLSCN53	15.87	4.76	1.2	1.2	1.6	1.6	P Type Boring Bar (E038)
	LLSCN63	19.05	4.76	1.2	1.2	1.6	1.6	HSK Tool Holder (H001)
	* LLSCP42	12.70	3.18	0.8	0.8	1.2	1.2	DOUBLE CLAMP DIMPLE BAR (E015)
	* LLSDP63	19.05	4.76	1.2	1.2	1.6	1.6	P Type Boring Bar (E038)
								HSK Tool Holder (H001)
	LLSDN32	9.52	3.18	0.8	1.2	—	—	DOUBLE CLAMP Holder (C010)
	LLSDN42	12.70	3.18	0.8	1.2	—	—	LL Type Holder (C010)
	LLSDN43	12.70	4.76	0.8	1.2	—	—	DOUBLE CLAMP DIMPLE BAR (E015)
	LLSDN53	15.87	4.76	1.2	1.6	—	—	P Type Boring Bar (E038)
	* LLSDP42	12.70	3.18	0.8	1.2	—	—	DOUBLE CLAMP DIMPLE BAR (E015)
	LLSRN103	8.3	3.18	—	—	—	—	LL Type Holder (C026)
	LLSRN123	9.8	3.18	—	—	—	—	HSK Tool Holder (H001)
	LLSRN164	13.6	4.76	—	—	—	—	
	LLSRN204	17.3	4.76	—	—	—	—	
	LLSRN256	22.0	6.35	—	—	—	—	
	LLSRN326	28.0	6.35	—	—	—	—	
	LLSSN32	9.52	3.18	0.8	0.8	1.2	1.2	DOUBLE CLAMP DIMPLE BAR (E016)
	LLSSN33	9.52	4.76	0.8	0.8	1.2	1.2	
	LLSSN42	12.70	3.18	0.8	0.8	1.2	1.6	
	LLSSN53	15.87	4.76	1.2	1.2	1.6	1.6	
	LLSSN63	19.05	4.76	1.2	1.2	1.6	2.0	
LLSSN84	25.40	6.35	1.6	1.6	2.4	2.4	DOUBLE CLAMP DIMPLE BAR (E016)	
* LLSSP42	12.70	3.18	0.8	0.8	1.2	1.6		

N
SPARE PARTS

SPARE PARTS

SHIM

SPARE PARTS

Geometry	Order Number	Dimensions (mm)						Tool Holder
		MPCA	MPCB	MPCD	MPCE	MPCF	MPCG	
	LLSTE32	7.6	3.18	0.4	0.4	0.4	—	LL Type Holder (☉C016) DOUBLE CLAMP DIMPLE BAR (☉E016) P Type Boring Bar (☉E037)
	LLSTN32	9.52	3.18	0.4	0.8	1.2	—	
	LLSTN33	9.52	4.76	0.4	0.8	1.2	—	
	LLSTN42	12.70	3.18	0.4	0.8	1.2	—	
	LLSTN53	15.87	4.76	0.8	1.2	1.6	—	
	* LLSTP32	9.52	3.18	0.4	0.8	1.2	—	
	LLSWN32	9.52	3.18	0.4	0.8	1.2	—	LL Type Holder (☉C022) DOUBLE CLAMP Holder (☉C022) DOUBLE CLAMP DIMPLE BAR (☉E017)
	LLSWN3T3	9.52	3.97	0.4	0.8	1.2	—	
	LLSWN42	12.70	3.18	0.4	0.8	1.2	—	
	* LLSWP32	9.52	3.18	0.4	0.8	1.2	—	
	* LLSWP42	12.70	3.18	0.4	0.8	1.2	—	
	MHS532R/L	9.4	15.7	4.5	0.8	0.8	—	
	MHS533R/L	9.4	15.7	4.5	1.2	1.2	—	
	MHS534R/L	9.4	15.7	4.5	1.6	1.6	—	
	MHS543R/L	9.4	15.7	6.5	1.2	1.2	—	
	MLCP42	12.58	3.18	1.2	1.2	1.2	1.2	P Type Boring Bar (☉E038)
	MLDP42	12.56	3.18	1.2	1.2	—	—	P Type Boring Bar (☉E038)
	MLSP42	12.63	3.18	1.2	1.2	1.2	1.2	P Type Boring Bar (☉E037)
	MLTP32	9.50	3.18	1.2	1.2	1.2	—	P Type Boring Bar (☉E037)
	MSCN63	18.8	4.76	1.6	1.6	1.6	1.6	DOUBLE CLAMP Holder (☉C009) (For Heavy Cutting)
	MSSN63	18.8	4.76	1.6	1.6	1.6	1.6	DOUBLE CLAMP Holder (☉C012) (For Heavy Cutting)
	CT32T1	9.525	15.03	3.18	—	—	—	
	* PT32T1R	8.28	13.34	3.18	—	—	—	
	* PT32T2R	8.28	13.19	3.18	—	—	—	

Geometry	Order Number	Dimensions (mm)						Tool Holder
		MPCA	MPCB	MPCC	MPCD	MPCE	MPCF	
	PV321	9.52	3.18	0.4	0.4	—	—	MP Type Holder (☉C019)
	PV322	9.52	3.18	0.8	0.8	—	—	
	PV323	9.52	3.18	1.2	1.2	—	—	
	SPSVN32	8.06	3.18	0.3	0.3	—	—	SP Type Holder (☉C030) HSK Tool Holder (☉H001)
	STASX400N	11.00	3.00	0.4	0.4	0.4	0.4	ASX400 (☉K068)
	STASX445N	10.76	3.00	—	—	—	—	ASX445 (☉K026)
	STBS500N	12.7	3.18	0.8	0.8	0.8	0.8	
	WPSTN33	9.3	4.76	0.8	0.4	1.2	—	WP Type Holder (☉C017)
	WPSTN43	12.50	4.76	0.8	0.4	1.2	—	
	* WPSWC43	12.50	4.76	0.4	0.8	1.2	—	WP Type Holder (☉C023)
	WPSWN43	12.50	4.76	0.4	0.8	1.2	—	

SPARE PARTS

SHIM PIN AND CLAMP LEVER

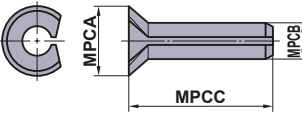
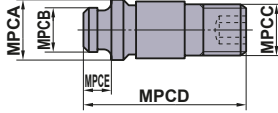
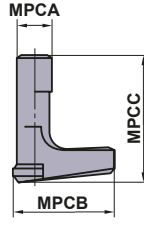
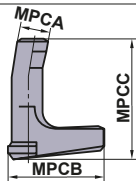
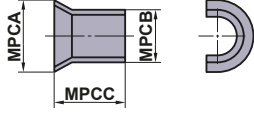
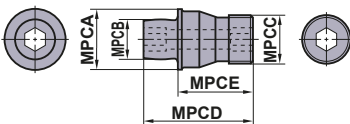
Geometry	Order Number	Dimensions (mm)					Tool Holder
		MPCA	MPCB	MPCC	MPCD	MPCE	
	BCP141	3.0	1.4	5.6	—	—	SP Type Holder (☉C030) F Type Boring Bar (☉E028) HSK Tool Holder (☉H013)
	BCP201	4.3	2	7.4	—	—	
	BCP202	4.3	2	6.4	—	—	
	BCP251	4.8	2.5	7.4	—	—	
	BCP252	4.8	2.5	6.4	—	—	
	BCP301	5.3	3	7.4	—	—	
	CCP33	6.5	3.66	M5×0.8	18.5	3	WP Holder (☉C017)
	CCP34	7.5	5.0	M6×1.0	18.5	3	
	CCP44	7.5	5.0	M5×0.8	14.2	3	
	LLCL12S	2.1	9.3	5.6	—	—	LL Type Holder (☉C016) P Type Boring Bar (☉E037) HSK Tool Holder (☉H001)
	LLCL13	3.6	10	12.5	—	—	
	LLCL13S	3.6	10	7.8	—	—	
	LLCL14	4.7	13.4	13.2	—	—	
	LLCL14S	4.7	13.6	12.2	—	—	
	LLCL15	6.0	19	17	—	—	
	LLCL16	7.5	20.8	21	—	—	
	LLCL18	8.6	25.4	25.2	—	—	
	LLCL23	3.6	12.0	11.5	—	—	
	LLCL23S	3.6	11.6	9.5	—	—	
	LLCL24	4.7	16.2	14.8	—	—	
	LLCL25	6.0	17.1	17	—	—	
	LLCL110	3.0	10.7	11.6	—	—	LL Type Holder (☉C008) DOUBLE CLAMP Holder (☉C008) DOUBLE CLAMP DIMPLE BAR (☉E015) P Type Boring Bar (☉E037) HSK Tool Holder (☉H001)
	LLCL112	3.5	13	13.5	—	—	
	LLCL116	4.5	18.5	18	—	—	
	LLCL120	5.6	20.3	19	—	—	
	LLCL125	6	24	24	—	—	
	LLCL132	8	30	27	—	—	
	LLP13	5.55	4.85	5.3	—	—	LL Type Holder (☉C008) DOUBLE CLAMP Holder (☉C008) DOUBLE CLAMP DIMPLE BAR (☉E015) P Type Boring Bar (☉E037) HSK Tool Holder (☉H001)
	LLP14	7.25	6.55	5.8	—	—	
	LLP15	8.8	8.05	8.6	—	—	
	LLP16	10.85	9.85	11.1	—	—	
	LLP18	15.35	13.05	12.0	—	—	
	LLP23	5.55	4.85	6.8	—	—	
	LLP24	7.25	6.55	9.1	—	—	
	MP6	11.9	7.8	M10×1	22.1	15	DOUBLE CLAMP Holder (☉C009) (For Heavy Cutting)

SPARE PARTS

N

LOCK PIN

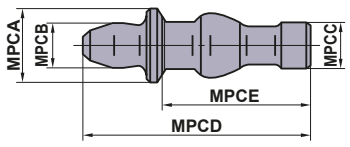
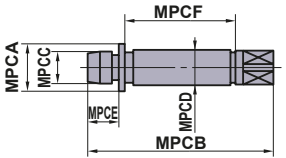
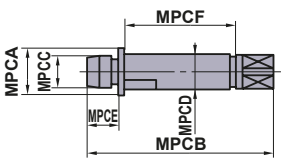
Geometry	Order Number	Dimensions (mm)						Tool Holder
		MPCA	MPCB	MPCC	MPCD	MPCE	MPCF	
	P11S	6	3.7	4	17	11.1	—	MP Type Holder (C019)
	P21S	7.5	4.9	4.5	17.2	11.5	—	
	P221US	4	18	2.11	3.5	3.3	7.7	
	P333WS	5.75	24	3.64	5.0	4.9	11.3	
	P434W	7.75	30	5.03	7.0	4.9	16.8	

CLAMP BRIDGE

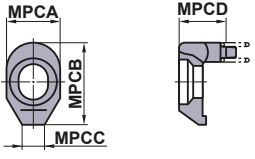
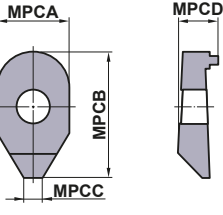
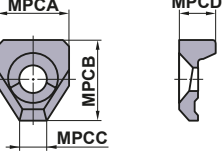
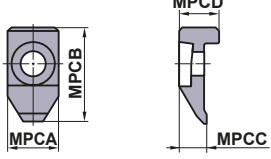
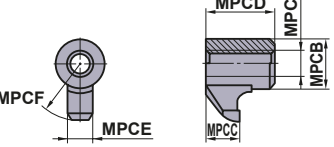
Geometry	Order Number	Dimensions (mm)						Tool Holder
		MPCA	MPCB	MPCC	MPCD	MPCE	MPCF	
	AMS3	7	12	3	3.3	—	—	Profile Holder (C032) AJX (K180)
	AMS4	9	13.5	3	3.8	—	—	
	AMS5	10	15	3.5	5	—	—	
	CA142	8	15	4	7	—	—	
	CA150	9	16	4.5	7	—	—	
	CA151	10	17	5	7	—	—	
	CA152	10	19	5	7	—	—	
	CA153	10	24	5	7	—	—	
	CA161	13	20	6	8	—	—	
	CA162	13	24	6	8	—	—	
	CA163	13	27	6	8	—	—	
	CCK13	15	18.5	6	9	—	—	WP Type Holder (C017)
	CCK14	19	22	8	9.5	—	—	
	CCTC1	13	25	7	10.2	—	—	
	CK231	M6×1	8	4	7.5	4.5	9.5	
	CK232	M6×1	8	4.5	8	4.5	11.5	
	CK341	M8×1	11	5.5	13.5	6	13.5	
	CK342	M8×1	11	6	14	6	16.5	

N

SPARE PARTS

SPARE PARTS

CLAMP BRIDGE

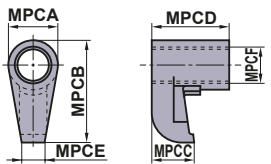
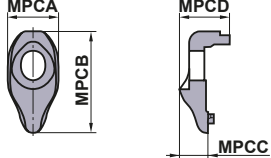
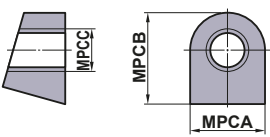
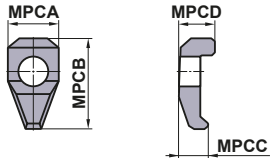
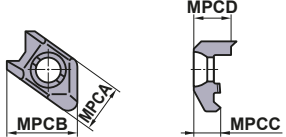
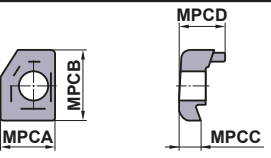
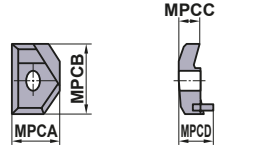
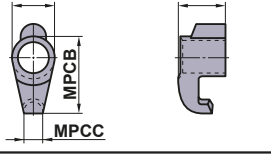
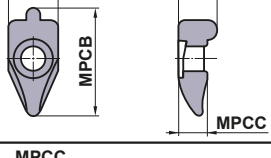
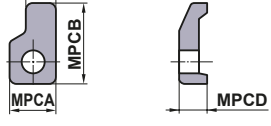
Geometry	Order Number	Dimensions (mm)						Tool Holder
		MPCA	MPCB	MPCC	MPCD	MPCE	MPCF	
	CKW6	10.9	22.5	9.2	16.8	5	M8×1	DOUBLE CLAMP Holder (☉C009) (For Heavy Cutting)
	DCK2211 DCK2613 DCK3113	11 13 13	22 26.5 31	6.57 7.35 9	11.1 12.9 14.5	— — —	— — —	DOUBLE CLAMP Holder (☉C008) DOUBLE CLAMP DIMPLE BAR (☉E015) HSK Tool Holder (☉H001)
	KGC1	12.0	15.0	M7×0.75	—	—	—	
	LK1	8	14.3	4.5	5.9	—	—	
	MHK5NR/L	15.5	23.5	8.1	12.1	—	—	
	MTK1R/L	13	17.5	5	12	—	—	MG Type Holder (☉F124) MT Type Holder (☉G024) HSK Tool Holder (☉H001)
	MTK2R/L	18	28	7	14	—	—	
	SETK51 SETK61	6.8 8.9	14.5 18.1	2.9 4.1	8 8.6	— —	— —	MMTE Type Holder (☉G019) MMTI Type Holder (☉G026) HSK Tool Holder (☉H001)
	SRK1R	9.4	21	5.5	7.5	—	—	
	UCR	12	24	8	7	—	—	

SPARE PARTS

N

BREAKER PIECE

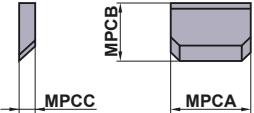
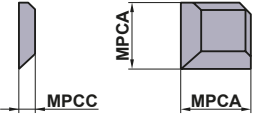
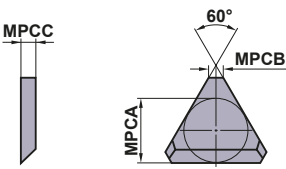
Geometry	Order Number	Dimensions (mm)					Tool Holder
		MPCA	MPCB	MPCC	IC	LBB	
	CBS3	9.4	8.0	1.5	9.525	1.5	
	CBS4	12.6	9.2	2.5	12.70	3.5	
	CBS4N	12.6	10.2	2.5	12.70	2.5	
	CBS4F	12.6	11.2	2.5	12.70	1.5	
	CBS6	18.9	14.6	2.5	19.05	4.5	
	CBS6F	18.9	17.6	2.5	19.05	1.5	
	CBS3D	8.0	—	1.5	9.525	1.5	
	CBS4D	10.2	—	2.5	12.70	2.5	
	CBT2N	5.67	1.4	1.5	6.35	1.0	F Type Boring Bar (E028) *For positive inserts, the breaker width is 0.5mm larger than the figures in the list.
	CBT3	7.20	1.4	2.5	9.525	3.5	
	CBT3N	7.87	1.4	2.5	9.525	2.5	
	CBT3F	8.53	1.4	2.5	9.525	1.5	
	CBT4N	11.07	1.4	2.5	12.70	2.5	
	CBT4F	11.73	1.4	2.5	12.70	1.5	

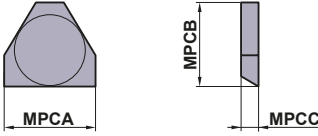
Geometry	Order Number	Dimensions (mm)			MPCD (mm)	Tool Holder
		MPCA	MPCB	MPCC		
	CBT3106	11.5	10.6	2.0	2.5—3.0	
	CBT3113	11.5	11.3	2.0	1.5—2.0	
	CBT3120	11.5	12	2.0	0.75—1.25	

N

SPARE PARTS

ANTI SEIZE LUBRICANT

ANTI SEIZE LUBRICANT

Shape	Order Number	Stock	Volume (g)
	MK1K	★	20
	MK1KS	★	3

N

SPARE PARTS

★ : Inventory maintained in Japan.

TECHNICAL DATA

ISO13399 COMPLIANCE	P002
TROUBLE SHOOTING FOR FACE MILLING	P006
FUNCTION OF TOOL FEATURES FOR FACE MILLING	P007
FORMULAE FOR FACE MILLING	P010
TROUBLE SHOOTING FOR END MILLING	P012
METALLIC MATERIALS CROSS REFERENCE LIST	P014
SURFACE ROUGHNESS	P018
HARDNESS COMPARISON TABLE	P019
FIT TOLERANCE TABLE (HOLE)	P020
FIT TOLERANCE TABLE (SHAFT)	P022
INTERNATIONAL SYSTEM OF UNITS	P024
TOOL WEAR AND DAMAGE	P025
CUTTING TOOL MATERIALS	P026
GRADE CHAIN	P027
GRADES COMPARISON TABLE	P028



ISO13399 COMPLIANCE

List of Property Symbols Complying with ISO13399

Alphabetical

Source: ISO13399 standard

URL : <https://www.iso.org/search/x/query/13399>

TECHNICAL DATA

P

ISO13399 Property Symbols	Content
ADJLX	Adjustment limit maximum
ADJRG	Adjustment range
ALF	Clearance angle radial
ALP	Clearance angle axial
AN	Clearance angle major
ANN	Clearance angle minor
APMX	Depth of cut maximum
AS	Clearance angle wiper edge
ASP	Adjusting screw protrusion
AZ	Plunge depth maximum
B	Shank width
BBD	Balanced by design
BCH	Corner chamfer length
BD	Body diameter
BDX	Body diameter maximum
BHCC	Bolt hole circle count
BHTA	Body half taper angle
BMC	Body material code
BS	Wiper edge length
BSR	Wiper edge radius
CASC	Cartridge size code
CB	Chipbreaker face count
CBDP	Connection bore depth
CBMD	Chipbreaker manufacturers designation
CBP	Chipbreaker property
CCMS	Connection code machine side
CCWS	Connection code workpiece side
CCP	Chamfer corner property
CDI	Insert cutting diameter
CDX	Cutting depth maximum
CEATC	Tool cutting edge angle type code
CECC	Cutting edge condition code
CEDC	Cutting edge count
CF	Spot chamfer
CHW	Corner chamfer width
CICT	Cutting item count
CNC	Corner count
CND	Coolant entry diameter
CNSC	Coolant entry style code
CNT	Coolant entry thread size
CP	Coolant pressure
CRE	Spot radius
CRKS	Connection retention knob thread size
CSP	Coolant supply property
CTP	Coating property
CTX	Cutting point translation X-direction
CTY	Cutting point translation Y-direction
CUTDIA	Work piece parting diameter maximum
CUB	Connection unit basis
CW	Cutting width
CWX	Cutting width maximum
CXD	Coolant exit diameter

ISO13399 Property Symbols	Content
CXSC	Coolant exit style code
CZC	Connection size code
D1	Fixing hole diameter
DAH	Diameter access hole
DAXN	Axial groove outside diameter minimum
DAXX	Axial groove outside diameter maximum
DBC	Diameter bolt circle
DC	Cutting diameter
DCB	Connection bore diameter
DCBN	Connection bore diameter minimum
DCBX	Connection bore diameter maximum
DCC	Design configuration style code
DCCB	Counterbore diameter connection bore
DCIN	Cutting diameter internal
DCINN	Cutting diameter internal minimum
DCINX	Cutting diameter internal maximum
DCN	Cutting diameter minimum
DCON	Connection diameter
DCONMS	Connection diameter machine side
DCONWS	Connection diameter workpiece side
DCSC	Cutting diameter size code
DCSFMS	Contact surface diameter machine side
DCX	Cutting diameter maximum
DF	Flange diameter
DHUB	Hub diameter
DMIN	Minimum bore diameter
DMM	Shank diameter
DN	Neck diameter
DRVA	Drive angle
EPSR	Insert included angle
FHA	Flute helix angle
FHCSA	Fixing hole countersunk angle
FHCSD	Fixing hole countersunk diameter
FLGT	Flange thickness
FMT	Form type
FXHLP	Fixing hole property
GAMF	Rake angle radial
GAMN	Rake angle normal
GAMO	Rake angle orthogonal
GAMP	Rake angle axial
GAN	Insert rake angle
H	Shank height
HA	Thread height theoretical
HAND	Hand
HBH	Head bottom offset height
HBKL	Head back offset length
HBKW	Head back offset width
HBL	Head bottom offset length
HC	Thread height actual
HF	Functional height
HHUB	Hub height
HTB	Body height
IC	Inscribed circle diameter
IFS	Insert mounting style code
IIC	Insert interface code
INSL	Insert length
KAPR	Tool cutting edge angle
KCH	Corner chamfer angle

TECHNICAL DATA

ISO13399 Property Symbols	Content
KRINS	Cutting edge angle major
KWW	Keyway width
KYP	Keyway property
L	Cutting edge length
LAMS	Inclination angle
LB	Body length
LBB	Chipbreaker width
LBX	Body length maximum
LCCB	Counterbore depth connection bore
LCF	Length chip flute
LDRED	Reduced body diameter length
LE	Cutting edge effective length
LF	Functional length
LFA	a dimension on lf
LH	Head length
LPR	Protruding length
LS	Shank length
LSC	Clamping length
LSCN	Clamping length minimum
LSCX	Clamping length maximum
LTA	LTA length (length from MCS to CRP)
LU	Usable length
LUX	Usable length maximum
M	m-dimension
M2	Distance between the nominal inscribed circle and the corner of an insert that has the secondary included angle
MHA	Mounting hole angle
MHD	Mounting hole distance
MHH	Mounting hole height
MIID	Master insert identification
MTP	Clamping type code
NCE	Cutting end count
NOF	Flute count
NOI	Insert index count
NT	Tooth count
OAH	Overall height
OAL	Overall length
OAW	Overall width
PDPT	Profile depth insert
PDX	Profile distance ex
PDY	Profile distance ey
PFS	Profile style code
PL	Point length
PNA	Profile included angle
PRFRAD	Profile radius
PSIR	Tool lead angle
PSIRL	Cutting edge angle major left hand
PSIRR	Cutting edge angle major right hand
RAL	Relief angle left hand
RAR	Relief angle right hand
RCP	Rounded corner property
RE	Corner radius
REL	Corner radius left hand
RER	Corner radius right hand
RMPX	Ramping angle maximum
RPMX	Rotational speed maximum
S	Insert thickness
S1	Insert thickness total
SC	Insert shape code
SDL	Step diameter length
SIG	Point angle

ISO13399 Property Symbols	Content
SSC	Insert seat size code
SX	Shank cross section shape code
TC	Tolerance class insert
TCE	Tipped cutting edge code
TCTR	Thread tolerance class
TD	Thread diameter
THFT	Thread form type
THL	Threading length
THLGTH	Thread length
THSC	Tool holder shape code
THUB	Hub thickness
TP	Thread pitch
TPI	Threads per inch
TPIN	Threads per inch minimum
TPIX	Threads per inch maximum
TPN	Thread pitch minimum
TPT	Thread profile type
TPX	Thread pitch maximum
TQ	Torque
TSYC	Tool style code
TTP	Thread type
ULDR	Usable length diameter ratio
UST	Unit system
W1	Insert width
WEP	Wiper edge property
WF	Functional width
WF2	Distance between the cutting reference point and the front seating surface of a turning tool
WFS	Functional width secondary
WT	Weight of item
ZEFF	Face effective cutting edge count
ZEFP	Peripheral effective cutting edge count
ZNC	Cutting edge center count
ZNF	Face mounted insert count
ZNP	Peripheral mounted insert count

List of Reference Symbols Complying with ISO13399

ISO13399 Reference Symbols	Content
CIP	Coordinate system In Process
CRP	Cutting Reference Point
CSW	Coordinate System Workpiece side
MCS	Mounting Coordinate System
PCS	Primary Coordinate System

FUNCTION OF TOOL FEATURES FOR FACE MILLING

FUNCTION OF EACH CUTTING EDGE ANGLE IN FACE MILLING

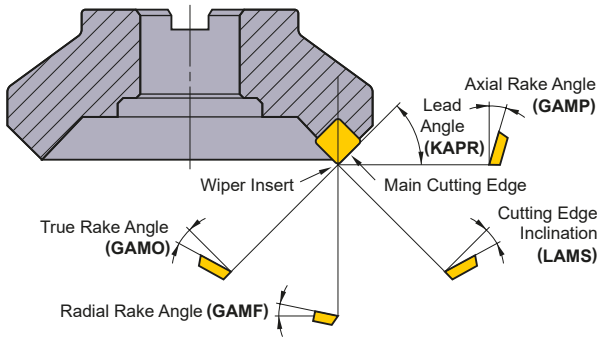

Each Cutting Edge Angle in Face Milling

Type of Angle	Symbol	Function	Effect
Axial Rake Angle	GAMP	Determines chip disposal direction.	Positive : Excellent machinability.
Radial Rake Angle	GAMF	Determines sharpness.	Negative : Excellent chip disposal.
Lead Angle	KAPR	Determines chip thickness.	Small : Thin chips and small cutting impact. Large back force.
True Rake Angle	GAMO	Determines actual sharpness.	Positive (large) : Excellent machinability. Minimal welding. Negative (large) : Poor machinability. Strong cutting edge.
Cutting Edge Inclination	LAMS	Determines chip disposal direction.	Positive (large) : Excellent chip disposal. Low cutting edge strength.

STANDARD INSERTS

Positive and Negative Rake Angle

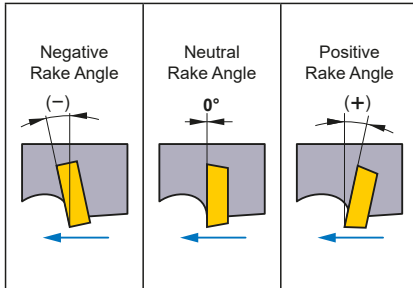

- Insert shape whose cutting edge precedes is a positive rake angle.
- Insert shape whose cutting edge follows is a negative rake angle.

Standard Cutting Edge Shape

Standard Cutting Edge Combinations	(+) Axial Rake Angle	(-) Axial Rake Angle	(+) Axial Rake Angle
	Radial Rake Angle (+)	Radial Rake Angle (-)	Radial Rake Angle (-)
	Double Positive (DP Edge Type)	Double Negative (DN Edge Type)	Negative/Positive (NP Edge Type)
Axial Rake Angle (GAMP)	Positive (+)	Negative (-)	Positive (+)
Radial Rake Angle (GAMF)	Positive (+)	Negative (-)	Negative (-)
Insert Used	Positive Insert (One Sided Use)	Negative Insert (Double Sided Use)	Positive Insert (One Sided Use)
Work Material	Steel	●	●
	Cast Iron	-	●
	Aluminium Alloy	●	-
	Difficult-to-Cut Material	●	-

LEAD ANGLE (KAPR) AND CUTTING CHARACTERISTICS

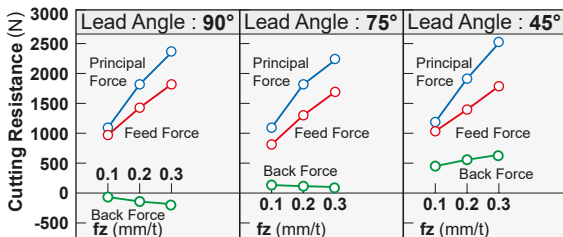

Workpiece: DIN 41CrMo4 (281HB)
Tool: $\phi 125$ mm Single Insert
Cutting Conditions: $V_c=125.6$ m/min $a_p=4$ mm $a_e=110$ mm

Cutting Resistance Comparison between Different Insert Shapes

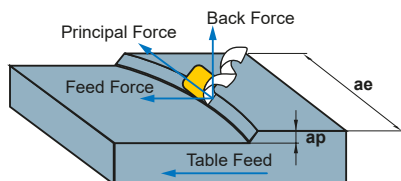

Three Cutting Resistance Forces in Milling

Lead Angle 90°

Back force is in the minus direction. Lifts the workpiece when workpiece clamp rigidity is low.

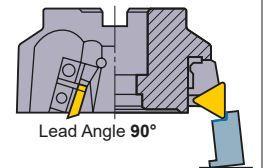

Lead Angle 75°

Lead angle 75° is recommended for face milling of workpieces with low rigidity such as thin workpieces.

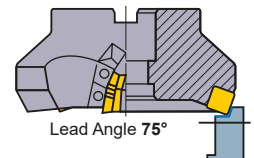

Lead Angle 45°

The largest back force. Bends thin workpieces and lowers cutting accuracy.
*Prevents workpiece edge chipping when cast iron cutting.

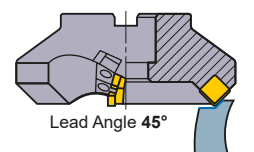

- * Principal force : Force is in the opposite direction of face milling rotation.
- * Back force : Force that pushes in the axial direction.
- * Feed force : Force is in the feed direction and is caused by table feed.

FUNCTION OF TOOL FEATURES FOR FACE MILLING

LEAD ANGLE AND TOOL LIFE

Lead angle and chip thickness

When the depth of cut and feed per tooth, f_z , are fixed, the smaller the lead angle (KAPR) is, then the thinner the chip thickness (h) becomes (for a 45° KAPR, it is approx. 75% that of a 90° KAPR). Therefore as the KAPR increases, the cutting resistance decreases resulting in longer tool life. Note however, if the chip thickness is too large then the cutting resistance can increase leading to vibrations and shortened tool life.

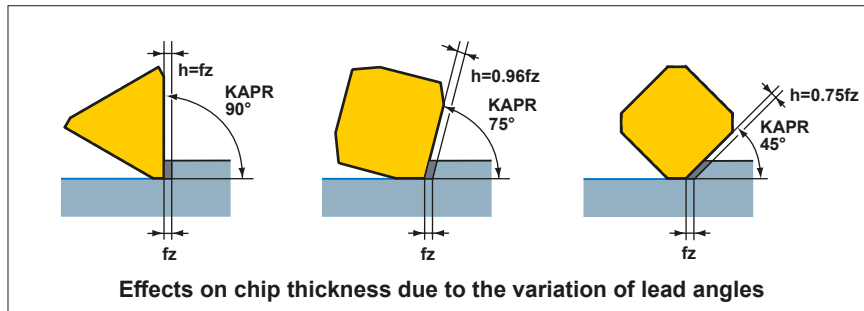

TECHNICAL DATA

Lead angle and crater wear

The table below shows wear patterns for different lead angles. When comparing crater wear for 90° and 45° lead angles, it can be clearly seen that the crater wear for 90° lead angle is larger. This is because if the chip thickness is relatively large, the cutting resistance increases and so promotes crater wear. As the crater develops then cutting edge strength will reduce and lead to fracturing.

	Lead Angle 90°	Lead Angle 75°	Lead Angle 45°
Vc=100m/min Tc=69min			
Vc=125m/min Tc=55min			
Vc=160m/min Tc=31min			

Workpiece : Alloy steel (287HB)
 Tools : DC=125 mm
 Insert : M20Cemented Carbide
 Cutting Conditions : $a_p=3.0$ mm
 $a_e=110$ m
 $f_z=0.2$ mm/t
 Dry Cutting

UP AND DOWN CUT (CLIMB) MILLING

When choosing a method to machine, up cutting or down cut milling (climb milling) is decided by the conditions of the machine tool, the milling cutter and the application. However, it is said that in terms of tool life, down cut (climb) milling is more advantageous.

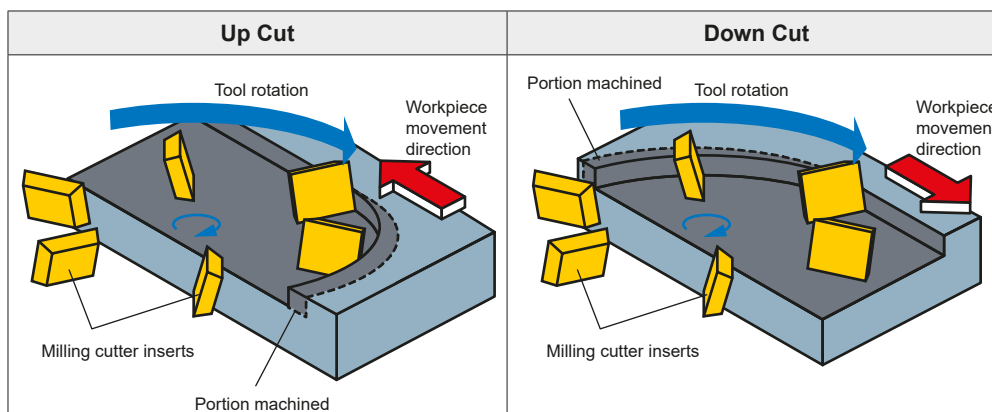

FINISHED SURFACE

Cutting Edge Run-out Accuracy

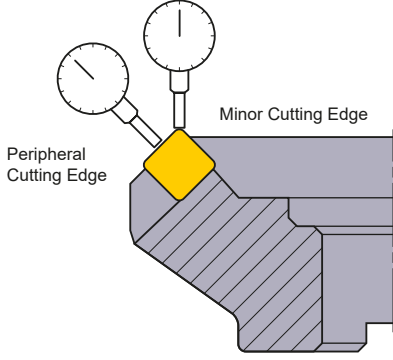

Cutting edge run-out accuracy of indexable inserts on the cutter body greatly affects the surface finish and tool life.

```

    graph LR
      Run-out -- Large --> Poor[Poor Finished Surface]
      Run-out -- Small --> Good[Good Finished Surface]
      Poor --> Chipping[Chipping Due to Vibration]
      Poor --> Wear[Rapid Wear Growth]
      Chipping --> Shorten[Shorten Tool Life]
      Wear --> Shorten
      Good --> Stable[Stable Tool Life]
  
```

Cutting Edge Run-out and Accuracy in Face Milling

Improve Finished Surface Roughness

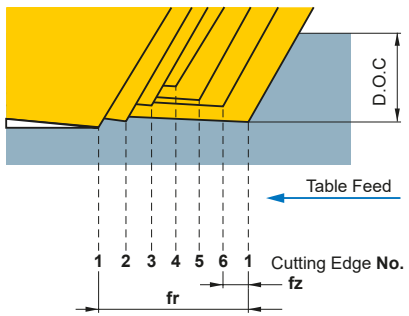

Since Mitsubishi Materials' normal sub cutting edge width is 1.4 mm, and the sub cutting edges are set parallel to the face of a milling cutter, theoretically the finished surface accuracy should be maintained even if run-out accuracy is low.

Actual Problems	Countermeasure
<ul style="list-style-type: none"> · Cutting edge run-out. · Sub cutting edge inclination. · Milling cutter body accuracy. · Spare parts accuracy. · Welding, vibration, chattering. 	<p>Wiper Insert</p> <ul style="list-style-type: none"> * Machine a surface that has already been machined with normal inserts in order to produce a smooth finished surface.

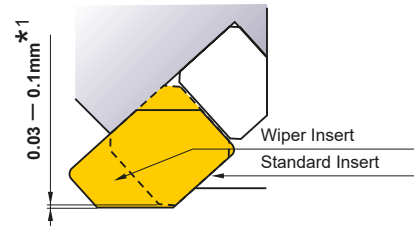

- Replace one or two normal inserts with wiper inserts.
- Wiper inserts are set to protrude by 0.03—0.1 mm from the standard inserts.

*1. Value depends on the cutting edge and insert combination.

Sub Cutting Edge Run-out and Finished Surface

How to Set a Wiper Insert

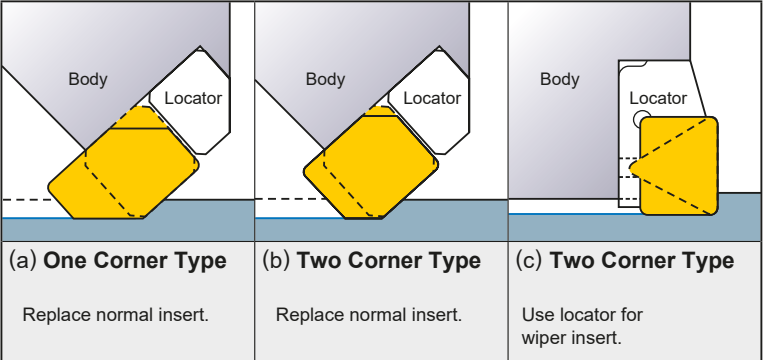

- Sub cutting edge length has to be longer than the feed per revolution.
- * A sub cutting edge that is too long causes chatter.
- When the cutter diameter is large and feed per revolution is longer than the sub cutting edge of the wiper insert, use two or three wiper inserts.
- When using more than 1 wiper insert, run-out needs to be eliminated.
- Use a high hardness grade (high wear resistance) for wiper inserts.

<p>(a) One Corner Type</p> <p>Replace normal insert.</p>	<p>(b) Two Corner Type</p> <p>Replace normal insert.</p>	<p>(c) Two Corner Type</p> <p>Use locator for wiper insert.</p>
--	--	---

FORMULAE FOR FACE MILLING

■ CUTTING SPEED (Vc)

$$V_c = \frac{\pi \cdot DC \cdot n}{1000} \text{ (m/min)}$$

*Divide by 1000 to change to m from mm.

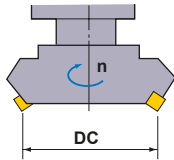

Vc (m/min) : Cutting Speed
 π (3.14) : Pi

DC (mm) : Cutter Diameter
 n (min⁻¹) : Main Axis Spindle Speed

(Example) What is the cutting speed when the main axis spindle speed is 350min⁻¹ and the cutter diameter is ϕ 125 ?

(Answer) Substitute $\pi=3.14$, DC=125, n=350 into the formula.

$$V_c = \frac{\pi \cdot DC \cdot n}{1000} = \frac{3.14 \times 125 \times 350}{1000} = 137.4 \text{ m/min}$$

The cutting speed is 137.4 m/min.

TECHNICAL DATA

■ FEED PER TOOTH (fz)

$$f_z = \frac{V_f}{z \cdot n} \text{ (mm/t.)}$$

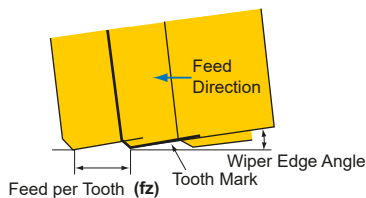

fz (mm/t.) : Feed per Tooth

z : Insert Number

Vf (mm/min) : Table Feed per Min.

n (min⁻¹) : Main Axis Spindle Speed (Feed per Revolution $f = z \times fz$)

(Example) What is the feed per tooth when the main axis spindle speed is 500min⁻¹, insert number is 10, and the table feed is 500mm/min ?

(Answer) Substitute the above figures into the formula.

$$f_z = \frac{V_f}{z \cdot n} = \frac{500}{10 \times 500} = 0.1 \text{ mm/t.}$$

The answer is 0.1mm/t.

■ TABLE FEED (Vf)

$$V_f = f_z \cdot z \cdot n \text{ (mm/min)}$$

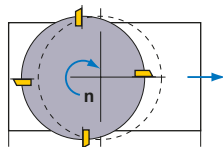

Vf (mm/min) : Table Feed per Min.

z : Insert Number

fz (mm/t.) : Feed per Tooth

n (min⁻¹) : Main Axis Spindle Speed

(Example) What is the table feed when feed per tooth is 0.1 mm/t., insert number is 10, and the main axis spindle speed is 500 min⁻¹?

(Answer) Substitute the above figures into the formula.

$$V_f = f_z \cdot z \cdot n = 0.1 \times 10 \times 500 = 500 \text{ mm/min}$$

The table feed is 500 mm/min.

■ CUTTING TIME (Tc)

$$T_c = \frac{L}{V_f} \text{ (min)}$$

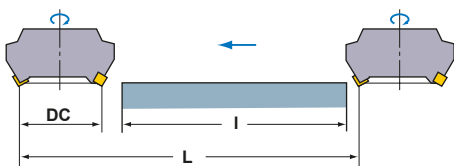

Tc (min) : Cutting Time

Vf (mm/min) : Table Feed per Min.

L (mm) : Total Table Feed Length (Workpiece Length: I+Cutter Diameter : DC)

(Example) What is the cutting time required for finishing 100mm width and 300mm length surface of a cast iron (GG20) block when the cutter diameter is ϕ 200, the number of inserts is 16, the cutting speed is 125 m/min, and feed per tooth is 0.25 mm/t.. (spindle speed is 200 min⁻¹)

(Answer) Calculate table feed per min Vf=0.25×16×200=800 mm/min

Calculate total table feed length. L=300+200=500 mm

Substitute the above answers into the formula.

$$T_c = \frac{500}{800} = 0.625 \text{ (min)}$$

0.625×60=37.5 (sec). The answer is 37.5 sec.

■ CUTTING POWER (Pc)

$$P_c = \frac{a_p \cdot a_e \cdot V_f \cdot K_c}{60 \times 10^6 \times \eta}$$

P_c (kW) : Actual Cutting Power
a_e (mm) : Cutting Width
K_c (MPa) : Specific Cutting Force

a_p (mm) : Depth of Cut
V_f (mm/min) : Table Feed per Min.
η : (Machine Coefficient)

(Example) What is the cutting power required for milling tool steel at a cutting speed of 80m/min. With depth of cut 2mm, cutting width 80mm, and table feed 280mm/min by ϕ 250 cutter with 12 inserts. Machine coefficient 80%.

(Answer) First, calculate the spindle speed in order to obtain the feed per tooth.

$$n = \frac{1000V_c}{\pi DC} = \frac{1000 \times 80}{3.14 \times 250} = 101.91 \text{ min}^{-1}$$

$$\text{Feed per Tooth } fz = \frac{V_f}{z \times n} = \frac{280}{12 \times 101.9} = 0.228 \text{ mm/t}$$

Substitute the specific cutting force into the formula.

$$P_c = \frac{2 \times 80 \times 280 \times 1800}{60 \times 10^6 \times 0.8} = 1.68 \text{ kW}$$

● K_c

Work Material	Tensile Strength (MPa) and Hardness	Specific Cutting Force K _c (MPa)				
		0.1mm/t	0.2mm/t	0.3mm/t	0.4mm/t	0.6mm/t
Mild Steel	520	2200	1950	1820	1700	1580
Medium Steel	620	1980	1800	1730	1600	1570
Hard Steel	720	2520	2200	2040	1850	1740
Tool Steel	670	1980	1800	1730	1700	1600
Tool Steel	770	2030	1800	1750	1700	1580
Chrome Manganese Steel	770	2300	2000	1880	1750	1660
Chrome Manganese Steel	630	2750	2300	2060	1800	1780
Chrome Molybdenum Steel	730	2540	2250	2140	2000	1800
Chrome Molybdenum Steel	600	2180	2000	1860	1800	1670
Nickel Chrome Molybdenum Steel	940	2000	1800	1680	1600	1500
Nickel Chrome Molybdenum Steel	352HB	2100	1900	1760	1700	1530
Austenitic Stainless Steel	155HB	2030	1970	1900	1770	1710
Cast Iron	520	2800	2500	2320	2200	2040
Hard Cast Iron	46HRC	3000	2700	2500	2400	2200
Meehanite Cast Iron	360	2180	2000	1750	1600	1470
Grey Cast Iron	200HB	1750	1400	1240	1050	970
Brass	500	1150	950	800	700	630
Light Alloy (Al-Mg)	160	580	480	400	350	320
Light Alloy (Al-Si)	200	700	600	490	450	390
Light Alloy (Al-Zn-Mg-Cu)	570	880	840	840	810	720

Memo

A series of horizontal dashed lines for writing.

TECHNICAL DATA

METALLIC MATERIALS CROSS REFERENCE LIST

■ CARBON STEEL

Germany		U.K.		France	Italy	Spain	Sweden	Japan	USA	China
W-nr.	DIN	BS	EN	AFNOR	UNI	UNE	SS	JIS	AISI/SAE	GB
1.0038	RSt.37-2	4360 40 C	–	E 24-2 Ne	–	–	1311	STKM 12A STKM 12C	A570.36	15
1.0401	C15	080M15	–	CC12	C15, C16	F.111	1350	–	1015	15
1.0402	C22	050A20	2C	CC20	C20, C21	F.112	1450	–	1020	20
1.0715	9SMn28	230M07	1A	S250	CF9SMn28	F.2111 11SMn28	1912	SUM22	1213	Y15
1.0718	9SMnPb28	–	–	S250Pb	CF9SMnPb28	11SMnPb28	1914	SUM22L	12L13	–
1.0722	10SPb20	–	–	10PbF2	CF10Pb20	10SPb20	–	–	–	–
1.0736	9SMn36	240M07	1B	S300	CF9SMn36	12SMn35	–	–	1215	Y13
1.0737	9SMnPb36	–	–	S300Pb	CF9SMnPb36	12SMnP35	1926	–	12L14	–
1.1141	Ck15	080M15	32C	XC12	C16	C15K	1370	S15C	1015	15
1.1158	Ck25	–	–	–	–	–	–	S25C	1025	25
1.8900	StE380	4360 55 E	–	–	FeE390KG	–	2145	–	A572-60	–
1.0501	C35	060A35	–	CC35	C35	F.113	1550	–	1035	35
1.0503	C45	080M46	–	CC45	C45	F.114	1650	–	1045	45
1.0726	35S20	212M36	8M	35MF4	–	F210G	1957	–	1140	–
1.1157	40Mn4	150M36	15	35M5	–	–	–	–	1039	40Mn
1.1167	36Mn5	–	–	40M5	–	36Mn5	2120	SMn438(H)	1335	35Mn2
1.1170	28Mn6	150M28	14A	20M5	C28Mn	–	–	SCMn1	1330	30Mn
1.1183	Cf35	060A35	–	XC38TS	C36	–	1572	S35C	1035	35Mn
1.1191	Ck45	080M46	–	XC42	C45	C45K	1672	S45C	1045	Ck45
1.1213	Cf53	060A52	–	XC48TS	C53	–	1674	S50C	1050	50
1.0535	C55	070M55	9	–	C55	–	1655	–	1055	55
1.0601	C60	080A62	43D	CC55	C60	–	–	–	1060	60
1.1203	Ck55	070M55	–	XC55	C50	C55K	–	S55C	1055	55
1.1221	Ck60	080A62	43D	XC60	C60	–	1678	S58C	1060	60Mn
1.1274	Ck101	060A96	–	XC100	–	F.5117	1870	–	1095	–
1.1545	C105W1	BW1A	–	Y105	C36KU	F.5118	1880	SK3	W1	–
1.1545	C105W1	BW2	–	Y120	C120KU	F.515	2900	SUP4	W210	–

■ ALLOY STEEL

Germany		U.K.		France	Italy	Spain	Sweden	Japan	USA	China
W-nr.	DIN	BS	EN	AFNOR	UNI	UNE	SS	JIS	AISI/SAE	GB
1.0144	St.44.2	4360 43 C	–	E28-3	–	–	1412	SM400A, SM400B SM400C	A573-81	–
1.0570	St52-3	4360 50 B	–	E36-3	Fe52BFN Fe52CFN	–	2132	SM490A, SM490B SM490C	–	–
1.0841	St52-3	150M19	–	20MC5	Fe52	F.431	2172	–	5120	–
1.0904	55Si7	250A53	45	55S7	55Si8	56Si7	2085	–	9255	55Si2Mn
1.0961	60SiCr7	–	–	60SC7	60SiCr8	60SiCr8	–	–	9262	–
1.3505	100Cr6	534A99	31	100C6	100Cr6	F.131	2258	SUJ2	ASTM 52100	Gr15, 45G
1.5415	15Mo3	1501-240	–	15D3	16Mo3KW	16Mo3	2912	–	ASTM A204Gr.A	–
1.5423	16Mo5	1503-245-420	–	–	16Mo5	16Mo5	–	–	4520	–
1.5622	14Ni6	–	–	16N6	14Ni6	15Ni6	–	–	ASTM A350LF5	–
1.5662	X8Ni9	1501-509-510	–	–	X10Ni9	XBNI09	–	–	ASTM A353	–
1.5710	36NiCr6	640A35	111A	35NC6	–	–	–	SNC236	3135	–
1.5732	14NiCr10	–	–	14NC11	16NiCr11	15NiCr11	–	SNC415(H)	3415	–
1.5752	14NiCr14	655M13	36A	12NC15	–	–	–	SNC815(H)	3415, 3310	–
1.6523	21NiCrMo2	805M20	362	20NCD2	20NiCrMo2	20NiCrMo2	2506	SNCM220(H)	8620	–
1.6546	40NiCrMo22	311-Type 7	–	–	40NiCrMo2(KB)	40NiCrMo2	–	SNCM240	8740	–
1.6587	17CrNiMo6	820A16	–	18NCD6	–	14NiCrMo13	–	–	–	–
1.7015	15Cr3	523M15	–	12C3	–	–	–	SCr415(H)	5015	15Cr

Germany		U.K.		France	Italy	Spain	Sweden	Japan	USA	China
W-nr.	DIN	BS	EN	AFNOR	UNI	UNE	SS	JIS	AISI/SAE	GB
1.7045	42Cr4	–	–	–	–	42Cr4	2245	SCr440	5140	40Cr
1.7176	55Cr3	527A60	48	55C3	–	–	–	SUP9(A)	5155	20CrMn
1.7262	15CrMo5	–	–	12CD4	–	12CrMo4	2216	SCM415(H)	–	–
1.7335	13CrMo4 4	1501-620Gr27	–	15CD3.5 15CD4.5	14CrMo45	14CrMo45	–	–	ASTM A182 F11, F12	–
1.7380	10CrMo910	1501-622 Gr31, 45	–	12CD9 12CD10	12CrMo9 12CrMo10	TU.H	2218	–	ASTM A182 F.22	–
1.7715	14MoV63	1503-660-440	–	–	–	13MoCrV6	–	–	–	–
1.8523	39CrMoV13 9	897M39	40C	–	36CrMoV12	–	–	–	–	–
1.6511	36CrNiMo4	816M40	110	40NCD3	38NiCrMo4(KB)	35NiCrMo4	–	–	9840	–
1.6582	34CrNiMo6	817M40	24	35NCD6	35NiCrMo6(KB)	–	2541	–	4340	40CrNiMoA
1.7033	34Cr4	530A32	18B	32C4	34Cr4(KB)	35Cr4	–	SCr430(H)	5132	35Cr
1.7035	41Cr4	530M40	18	42C4	41Cr4	42Cr4	–	SCr440(H)	5140	40Cr
1.7131	16MnCr5	(527M20)	–	16MC5	16MnCr5	16MnCr5	2511	–	5115	18CrMn
1.7218	25CrMo4	1717CDS110 708M20	–	25CD4	25CrMo4(KB)	55Cr3	2225	SCM420 SCM430	4130	30CrMn
1.7220	34CrMo4	708A37	19B	35CD4	35CrMo4	34CrMo4	2234	SCM432 SCCRM3	4137 4135	35CrMo
1.7223	41CrMo4	708M40	19A	42CD4TS	41CrMo4	42CrMo4	2244	SCM 440	4140 4142	40CrMoA
1.7225	42CrMo4	708M40	19A	42CD4	42CrMo4	42CrMo4	2244	SCM440(H)	4140	42CrMo 42CrMnMo
1.7361	32CrMo12	722M24	40B	30CD12	32CrMo12	F.124.A	2240	–	–	–
1.8159	50CrV4	735A50	47	50CV4	50CrV4	51CrV4	2230	SUP10	6150	50CrVA
1.8509	41CrAlMo7	905M39	41B	40CAD6 40CAD2	41CrAlMo7	41CrAlMo7	2940	–	–	–
1.2067	100Cr6	BL3	–	Y100C6	–	100Cr6	–	–	L3	CrV, 9SiCr
1.2419	105WCr6	–	–	105WC13	100WCr6 107WCr5KU	105WCr5	2140	SKS31 SKS2, SKS3	–	CrWMo
1.2713	55NiCrMoV6	BH224/5	–	55NCDV7	–	F.520.S	–	SKT4	L6	5CrNiMo
1.5662	X8Ni9	1501-509	–	–	X10Ni9	XBNI09	–	–	ASTM A353	–
1.5680	12Ni19	–	–	Z18N5	–	–	–	–	2515	–
1.6657	14NiCrMo134	832M13	36C	–	15NiCrMo13	14NiCrMo131	–	–	–	–
1.2080	X210Cr12	BD3	–	Z200C12	X210Cr13KU X250Cr12KU	X210Cr12	–	SKD1	D3 ASTM D3	Cr12
1.2601	X153CrMoV12	BD2	–	–	X160CrMoV12	–	–	SKD11	D2	Cr12MoV
1.2363	X100CrMoV5	BA2	–	Z100CDV5	X100CrMoV5	F.5227	2260	SKD12	A2	Cr5Mo1V
1.2344	X40CrMoV51 X40CrMoV51	BH13	–	Z40CDV5	X35CrMoV05KU X40CrMoV51KU	X40CrMoV5	2242	SKD61	H13 ASTM H13	40CrMoV5
1.2436	X210CrW12	–	–	–	X215CrW121KU	X210CrW12	2312	SKD2	–	–
1.2542	45WCrV7	BS1	–	–	45WCrV8KU	45WCrSi8	2710	–	S1	–
1.2581	X30WCrV93	BH21	–	Z30WCV9	X28W09KU	X30WCrV9	–	SKD5	H21	30WCrV9
1.2601	X165CrMoV12	–	–	–	X165CrMoV12KU	X160CrMoV12	2310	–	–	–
1.2833	100V1	BW2	–	Y1105V	–	–	–	SKS43	W210	V
1.3255	S 18-1-2-5	BT4	–	Z80WKCV	X78WCo1805KU	HS18-1-1-5	–	SKH3	T4	W18Cr4VCo5
1.3355	S 18-0-1	BT1	–	Z80WCV	X75W18KU	HS18-0-1	–	SKH2	T1	–
1.3401	G-X120Mn12	Z120M12	–	Z120M12	XG120Mn12	X120MN12	–	SCMnH/1	–	–
1.4718	X45CrSi93	401S45	52	Z45CS9	X45CrSi8	F.322	–	SUH1	HW3	X45CrSi93
1.3343	S6-5-2	4959BA2	–	Z40CSD10	15NiCrMo13	–	2715	SUH3	D3	–
1.3343	S6/5/2	BM2	–	Z85WDCV	HS6-5-2-2	F.5603	2722	SKH9, SKH51	M2	–
1.3348	S 2-9-2	–	–	–	HS2-9-2	HS2-9-2	2782	–	M7	–
1.3243	S6/5/2/5	BM35	–	6-5-2-5	HS6-5-2-5	F.5613	2723	SKH55	M35	–

TECHNICAL DATA

METALLIC MATERIALS CROSS REFERENCE LIST

■ STAINLESS STEEL (FERRITIC, MARTENSITIC)

Germany		U.K.		France	Italy	Spain	Sweden	Japan	USA	China
W-nr.	DIN	BS	EN	AFNOR	UNI	UNE	SS	JIS	AISI/SAE	GB
1.4000	X7Cr13	403S17	–	Z6C13	X6Cr13	F.3110	2301	SUS403	403	OCr13 1Cr12
1.4001	X7Cr14	–	–	–	–	F.8401	–	–	–	–
1.4005	X12CrS13	416S21	–	Z11CF13	X12CrS13	F.3411	2380	SUS416	416	–
1.4006	X10Cr13	410S21	56A	Z10C14	X12Cr13	F.3401	2302	SUS410	410	1Cr13
1.4016	X8Cr17	430S15	60	Z8C17	X8Cr17	F.3113	2320	SUS430	430	1Cr17
1.4027	G-X20Cr14	420C29	56B	Z20C13M	–	–	–	SCS2	–	–
1.4034	X46Cr13	420S45	56D	Z40CM Z38C13M	X40Cr14	F.3405	2304	SUS420J2	–	4Cr13
1.4003	–	405S17	–	Z8CA12	X6CrAl13	–	–	–	405	–
1.4021	–	420S37	–	Z8CA12	X20Cr13	–	2303	–	420	–
1.4057	X22CrNi17	431S29	57	Z15CNi6.02	X16CrNi16	F.3427	2321	SUS431	431	1Cr17Ni2
1.4104	X12CrMoS17	–	–	Z10CF17	X10CrS17	F.3117	2383	SUS430F	430F	Y1Cr17
1.4113	X6CrMo17	434S17	–	Z8CD17.01	X8CrMo17	–	2325	SUS434	434	1Cr17Mo
1.4313	X5CrNi134	425C11	–	Z4CND13.4M	(G)X6CrNi304	–	2385	SCS5	CA6-NM	–
1.4724	X10CrA113	403S17	–	Z10C13	X10CrA112	F.311	–	SUS405	405	OCr13Al
1.4742	X10CrA118	430S15	60	Z10CAS18	X8Cr17	F.3113	–	SUS430	430	Cr17
1.4747	X80CrNiSi20	443S65	59	Z80CSN20.02	X80CrSiNi20	F.320B	–	SUH4	HNV6	–
1.4762	X10CrA124	–	–	Z10CAS24	X16Cr26	–	2322	SUH446	446	2Cr25N
1.4871	X53CrMnNiN219	349S54	–	Z52CMN21.09	X53CrMnNiN219	–	–	SUH35	EV8	5Cr2Mn9Ni4N
1.4521	X1CrMoTi182	–	–	–	–	–	2326	–	S44400	–
1.4922	X20CrMoV12-1	–	–	–	X20CrMoNi1201	–	2317	–	–	–
1.4542	–	–	–	Z7CNU17-04	–	–	–	–	630	–

■ STAINLESS STEEL (AUSTENITIC)

Germany		U.K.		France	Italy	Spain	Sweden	Japan	USA	China
W-nr.	DIN	BS	EN	AFNOR	UNI	UNE	SS	JIS	AISI/SAE	GB
1.4306	X2CrNi1911	304S11	–	Z2CN18.10	X2CrNi18.11	–	2352	SUS304L	304L	OCr19Ni10
1.4350	X5CrNi189	304S11	58E	Z6CN18.09	X5CrNi1810	F.3551 F.3541 F.3504	2332	SUS304	304	OCr18Ni9
1.4305	X12CrNiS188	303S21	58M	Z10CNF18.09	X10CrNiS18.09	F.3508	2346	SUS303	303	1Cr18Ni9MoZr
–	–	304C12	–	Z3CN19.10	–	–	2333	SUS304L	–	–
1.4306	X2CrNi189	304S12	–	Z2CrNi1810	X2CrNi18.11	F.3503	2352	SCS19	304L	–
1.4310	X12CrNi177	–	–	Z12CN17.07	X12CrNi1707	F.3517	2331	SUS301	301	Cr17Ni7
1.4311	X2CrNiN1810	304S62	–	Z2CN18.10	–	–	2371	SUS304LN	304LN	–
1.4401	X5CrNiMo1810	316S16	58J	Z6CND17.11	X5CrNiMo1712	F.3543	2347	SUS316	316	OCr17Ni11Mo2
1.4308	G-X6CrNi189	304C15	–	Z6CN18.10M	–	–	–	SCS13	–	–
1.4408	G-X6CrNiMo1810	316C16	–	–	–	F.8414	–	SCS14	–	–
1.4581	G-X5CrNiMoNb1810	318C17	–	Z4CNDNb1812M	XG8CrNiMo1811	–	–	SCS22	–	–
1.4429	X2CrNiMoN1813	–	–	Z2CND17.13	–	–	2375	SUS316LN	316LN	OCr17Ni13Mo
1.4404	–	316S13	–	Z2CND17.12	X2CrNiMo1712	–	2348	–	316L	–
1.4435	X2CrNiMo1812	316S13	–	Z2CND17.12	X2CrNiMo1712	–	2353	SCS16 SUS316L	316L	OCr27Ni12Mo3
1.4436	–	316S13	–	Z6CND18-12-03	X8CrNiMo1713	–	2343, 2347	–	316	–
1.4438	X2CrNiMo1816	317S12	–	Z2CND19.15	X2CrNiMo1816	–	2367	SUS317L	317L	OCr19Ni13Mo
1.4539	X1NiCrMo	–	–	Z6CNT18.10	–	–	2562	–	UNS V 0890A	–
1.4541	X10CrNiTi189	321S12	58B	Z6CNT18.10	X6CrNiTi1811	F.3553 F.3523	2337	SUS321	321	1Cr18Ni9Ti
1.4550	X10CrNiNb189	347S17	58F	Z6CNNb18.10	X6CrNiNb1811	F.3552 F.3524	2338	SUS347	347	1Cr18Ni11Nb
1.4571	X10CrNiMoTi1810	320S17	58J	Z6CNDT17.12	X6CrNiMoTi1712	F.3535	2350	–	316Ti	Cr18Ni12Mo2T
1.4583	X10CrNiMoNb1812	–	–	Z6CNDNb1713B	X6CrNiMoNb1713	–	–	–	318	Cr17Ni12Mo3Mb

Germany		U.K.		France	Italy	Spain	Sweden	Japan	USA	China
W-nr.	DIN	BS	EN	AFNOR	UNI	UNE	SS	JIS	AISI/SAE	GB
1.4828	X15CrNiSi2012	309S24	–	Z15CNS20.12	X6CrNi2520	–	–	SUH309	309	1Cr23Ni13
1.4845	X12CrNi2521	310S24	–	Z12CN2520	X6CrNi2520	F.331	2361	SUH310	310S	OCr25Ni20
1.4406	X10CrNi18.08	–	58C	Z1NCDU25.20	–	F.8414	2370	SCS17	308	–
1.4418	X4CrNiMo165	–	–	Z6CND16-04-01	–	–	–	–	–	–
1.4568	–	316S111	–	Z8CNA17-07	X2CrNiMo1712	–	–	–	17-7PH	–
1.4504	–	–	–	–	–	–	–	–	–	–
1.4563	–	–	–	Z1NCDU31-27-03 Z1CNDU20-18-06AZ	–	–	2584 2378	–	NO8028 S31254	–
1.4878	X12CrNiTi189	321S32	58B, 58C	Z6CNT18.12B	X6CrNiTi18.11	F.3523	–	SUS321	321	1Cr18Ni9Ti

HEAT RESISTANT STEELS

Germany		U.K.		France	Italy	Spain	Sweden	Japan	USA	China
W-nr.	DIN	BS	EN	AFNOR	UNI	UNE	SS	JIS	AISI/SAE	GB
1.4864	X12NiCrSi3616	–	–	Z12NCS35.16	–	–	–	SUH330	330	–
1.4865	G-X40NiCrSi3818	330C11	–	–	XG50NiCr3919	–	–	SCH15	HT, HT 50	–

GRAY CAST IRON

Germany		U.K.		France	Italy	Spain	Sweden	Japan	USA	China
W-nr.	DIN	BS	EN	AFNOR	UNI	UNE	SS	JIS	AISI/SAE	GB
–	–	–	–	–	–	–	0100	–	–	–
–	GG 10	–	–	Ft 10 D	–	–	0110	FC100	No 20 B	–
0.6015	GG 15	Grade 150	–	Ft 15 D	G15	FG15	0115	FC150	No 25 B	HT150
0.6020	GG 20	Grade 220	–	Ft 20 D	G20	–	0120	FC200	No 30 B	HT200
0.6025	GG 25	Grade 260	–	Ft 25 D	G25	FG25	0125	FC250	No 35 B	HT250
–	–	–	–	–	–	–	–	–	No 40 B	–
0.6030	GG 30	Grade 300	–	Ft 30 D	G30	FG30	0130	FC300	No 45 B	HT300
0.6035	GG 35	Grade 350	–	Ft 35 D	G35	FG35	0135	FC350	No 50 B	HT350
0.6040	GG 40	Grade 400	–	Ft 40 D	–	–	0140	–	No 55 B	HT400
0.6660	GGL NiCr202	L-NiCuCr202	–	L-NC 202	–	–	0523	–	A436 Type 2	–

DUCTILE CAST IRON

Germany		U.K.		France	Italy	Spain	Sweden	Japan	USA	China
W-nr.	DIN	BS	EN	AFNOR	UNI	UNE	SS	JIS	AISI/SAE	GB
0.7040	GGG 40	SNG 420/12	–	FCS 400-12	GS 370-17	FGE 38-17	07 17-02	FCD400	60-40-18	QT400-18
–	GGG 40.3	SNG 370/17	–	FGS 370-17	–	–	07 17-12	–	–	–
0.7033	GGG 35.3	–	–	–	–	–	07 17-15	–	–	–
0.7050	GGG 50	SNG 500/7	–	FGS 500-7	GS 500	FGE 50-7	07 27-02	FCD500	80-55-06	QT500-7
0.7660	GGG NiCr202	Grade S6	–	S-NC202	–	–	07 76	–	A43D2	–
–	GGG NiMn137	L-NiMn 137	–	L-MN 137	–	–	07 72	–	–	–
–	GGG 60	SNG 600/3	–	FGS 600-3	–	–	07 32-03	FCD600	–	QT600-3
0.7070	GGG 70	SNG 700/2	–	FGS 700-2	GS 700-2	FGS 70-2	07 37-01	FCD700	100-70-03	QT700-18

MALLEABLE CAST IRON

Germany		U.K.		France	Italy	Spain	Sweden	Japan	USA	China
W-nr.	DIN	BS	EN	AFNOR	UNI	UNE	SS	JIS	AISI/SAE	GB
–	–	8 290/6	–	MN 32-8	–	–	08 14	FCMB310	–	–
–	GTS-35	B 340/12	–	MN 35-10	–	–	08 15	FCMW330	32510	–
0.8145	GTS-45	P 440/7	–	Mn 450	GMN45	–	08 52	FCMW370	40010	–
0.8155	GTS-55	P 510/4	–	MP 50-5	GMN55	–	08 54	FCMP490	50005	–
–	GTS-65	P 570/3	–	MP 60-3	–	–	08 58	FCMP540	70003	–
0.8165	GTS-65-02	P 570/3	–	Mn 650-3	GMN 65	–	08 56	FCMP590	A220-70003	–
–	GTS-70-02	P 690/2	–	Mn 700-2	GMN 70	–	08 62	FCMP690	A220-80002	–

SURFACE ROUGHNESS

SURFACE ROUGHNESS

(From JIS B 0601-1994)

Type	Code	Determination	Determination Example (Figure)
Arithmetical Mean Roughness	Ra	<p>Ra means the value obtained by the following formula and expressed in micrometer (μm) when sampling only the reference length from the roughness curve in the direction of the mean line, taking X-axis in the direction of mean line and Y-axis in the direction of longitudinal magnification of this sampled part and the roughness curve is expressed by $y=f(x)$:</p> $Ra = \frac{1}{l} \int_0^l f(x) dx$	
Maximum Height	Rz	<p>Rz shall be that only when the reference length is sampled from the roughness curve in the direction of the mean line, the distance between the top profile peak line and the bottom profile valley line on this sampled portion is measured in the longitudinal magnification direction of roughness curve and the obtained value is expressed in micrometer (μm).</p> <p>Note) When finding Rz, a portion without an exceptionally high peak or low valley, which may be regarded as a flaw, is selected as the sampling length.</p> $Rz = R_p + R_v$	
Ten-Point Mean Roughness	RzJIS	<p>RzJIS shall be that only when the reference length is sampled from the roughness curve in the direction of its mean line, the sum of the average value of absolute values of the heights of five highest profile peaks (Y_p) and the depths of five deepest profile valleys (Y_v) measured in the vertical magnification direction from the mean line of this sampled portion and this sum is expressed in micrometer (μm).</p> $Rz_{JIS} = \frac{(Y_{p1} + Y_{p2} + Y_{p3} + Y_{p4} + Y_{p5}) + (Y_{v1} + Y_{v2} + Y_{v3} + Y_{v4} + Y_{v5})}{5}$	<p>$Y_{p1}, Y_{p2}, Y_{p3}, Y_{p4}, Y_{p5}$: altitudes of the five highest profile peaks of the sampled portion corresponding to the reference length l.</p> <p>$Y_{v1}, Y_{v2}, Y_{v3}, Y_{v4}, Y_{v5}$: altitudes of the five deepest profile valleys of the sampled portion corresponding to the reference length l.</p>

TECHNICAL DATA

P

RELATIONSHIP BETWEEN ARITHMETICAL MEAN (Ra) AND CONVENTIONAL DESIGNATION (REFERENCE DATA)

Arithmetical Mean Roughness Ra		Max. Height Rz	Ten-Point Mean Roughness RzJIS	Sampling Length for Rz • RzJIS l (mm)	Conventional Finish Mark
Standard Series	Cutoff Value λ_c (mm)	Standard Series			
0.012 a	0.08	0.05s	0.05z	0.08	▽▽▽▽
0.025 a		0.1 s	0.1 z		
0.05 a	0.25	0.2 s	0.2 z	0.25	
0.1 a		0.4 s	0.4 z		
0.2 a		0.8 s	0.8 z		
0.4 a	0.8	1.6 s	1.6 z	0.8	▽▽▽
0.8 a		3.2 s	3.2 z		
1.6 a		6.3 s	6.3 z		
3.2 a		12.5 s	12.5 z		
6.3 a	2.5	25 s	25 z	2.5	▽▽
12.5 a		50 s	50 z		
25 a	8	100 s	100 z	8	▽
50 a		200 s	200 z		
100 a		400 s	400 z		

*The correlation among the three is shown for convenience and is not exact.

*Ra: The evaluation length of Rz and RzJIS is the cutoff value and sampling length multiplied by 5, respectively.

HARDNESS COMPARISON TABLE

HARDNESS CONVERSION NUMBERS OF STEEL

Brinell Hardness (HB), 10mm Ball, Load: 3000kgf		Vickers Hardness	Rockwell Hardness				Shore Hardness	Tensile Strength (Approx.) MPa	Brinell Hardness (HB), 10mm Ball, Load: 3000kgf		Vickers Hardness	Rockwell Hardness				Shore Hardness	Tensile Strength (Approx.) MPa
Standard Ball	Tungsten Carbide Ball		A Scale, Load: 60kgf, Diamond Point	B Scale, Load: 100kgf, 1/16" Ball	C Scale, Load: 150kgf, Diamond Point	D Scale, Load: 100kgf, Diamond Point			Standard Ball	Tungsten Carbide Ball		A Scale, Load: 60kgf, Diamond Point	B Scale, Load: 100kgf, 1/16" Ball	C Scale, Load: 150kgf, Diamond Point	D Scale, Load: 100kgf, Diamond Point		
		(HV)	(HRA)	(HRB)	(HRC)	(HRD)	(HS)			(HV)	(HRA)	(HRB)	(HRC)	(HRD)	(HS)	MPa	
—	—	940	85.6	—	68.0	76.9	97	—	429	429	455	73.4	—	45.7	59.7	61	1510
—	—	920	85.3	—	67.5	76.5	96	—	415	415	440	72.8	—	44.5	58.8	59	1460
—	—	900	85.0	—	67.0	76.1	95	—	401	401	425	72.0	—	43.1	57.8	58	1390
—	(767)	880	84.7	—	66.4	75.7	93	—	388	388	410	71.4	—	41.8	56.8	56	1330
—	(757)	860	84.4	—	65.9	75.3	92	—	375	375	396	70.6	—	40.4	55.7	54	1270
—	(745)	840	84.1	—	65.3	74.8	91	—	363	363	383	70.0	—	39.1	54.6	52	1220
—	(733)	820	83.8	—	64.7	74.3	90	—	352	352	372	69.3	(110.0)	37.9	53.8	51	1180
—	(722)	800	83.4	—	64.0	73.8	88	—	341	341	360	68.7	(109.0)	36.6	52.8	50	1130
—	(712)	—	—	—	—	—	—	—	331	331	350	68.1	(108.5)	35.5	51.9	48	1095
—	(710)	780	83.0	—	63.3	73.3	87	—	321	321	339	67.5	(108.0)	34.3	51.0	47	1060
—	(698)	760	82.6	—	62.5	72.6	86	—	—	—	—	—	—	—	—	—	—
—	(684)	740	82.2	—	61.8	72.1	—	—	311	311	328	66.9	(107.5)	33.1	50.0	46	1025
—	(682)	737	82.2	—	61.7	72.0	84	—	302	302	319	66.3	(107.0)	32.1	49.3	45	1005
—	(670)	720	81.8	—	61.0	71.5	83	—	293	293	309	65.7	(106.0)	30.9	48.3	43	970
—	(656)	700	81.3	—	60.1	70.8	—	—	285	285	301	65.3	(105.5)	29.9	47.6	—	950
—	(653)	697	81.2	—	60.0	70.7	81	—	277	277	292	64.6	(104.5)	28.8	46.7	41	925
—	(647)	690	81.1	—	59.7	70.5	—	—	269	269	284	64.1	(104.0)	27.6	45.9	40	895
—	(638)	680	80.8	—	59.2	70.1	80	—	262	262	276	63.6	(103.0)	26.6	45.0	39	875
—	630	670	80.6	—	58.8	69.8	—	—	255	255	269	63.0	(102.0)	25.4	44.2	38	850
—	627	667	80.5	—	58.7	69.7	79	—	248	248	261	62.5	(101.0)	24.2	43.2	37	825
—	—	677	80.7	—	59.1	70.0	—	—	241	241	253	61.8	100	22.8	42.0	36	800
—	601	640	79.8	—	57.3	68.7	77	—	235	235	247	61.4	99.0	21.7	41.4	35	785
—	—	640	79.8	—	57.3	68.7	—	—	229	229	241	60.8	98.2	20.5	40.5	34	765
—	578	615	79.1	—	56.0	67.7	75	—	223	223	234	—	97.3	(18.8)	—	—	—
—	—	607	78.8	—	55.6	67.4	—	—	217	217	228	—	96.4	(17.5)	—	33	725
—	555	591	78.4	—	54.7	66.7	73	2055	212	212	222	—	95.5	(16.0)	—	—	705
—	—	579	78.0	—	54.0	66.1	—	2015	207	207	218	—	94.6	(15.2)	—	32	690
—	534	569	77.8	—	53.5	65.8	71	1985	201	201	212	—	93.8	(13.8)	—	31	675
—	—	533	77.1	—	52.5	65.0	—	1915	197	197	207	—	92.8	(12.7)	—	30	655
—	514	547	76.9	—	52.1	64.7	70	1890	192	192	202	—	91.9	(11.5)	—	29	640
(495)	—	539	76.7	—	51.6	64.3	—	1855	187	187	196	—	90.7	(10.0)	—	—	620
—	495	528	76.3	—	51.0	63.8	68	1820	183	183	192	—	90.0	(9.0)	—	28	615
(477)	—	516	75.9	—	50.3	63.2	—	1780	179	179	188	—	89.0	(8.0)	—	27	600
—	—	508	75.6	—	49.6	62.7	—	1740	174	174	182	—	87.8	(6.4)	—	—	585
—	477	508	75.6	—	49.6	62.7	66	1740	170	170	178	—	86.8	(5.4)	—	26	570
(461)	—	495	75.1	—	48.8	61.9	—	1680	167	167	175	—	86.0	(4.4)	—	—	560
—	—	491	74.9	—	48.5	61.7	—	1670	163	163	171	—	85.0	(3.3)	—	25	545
—	461	491	74.9	—	48.5	61.7	65	1670	156	156	163	—	82.9	(0.9)	—	—	525
—	—	474	74.3	—	47.2	61.0	—	1595	149	149	156	—	80.8	—	—	23	505
—	—	472	74.2	—	47.1	60.8	—	1585	143	143	150	—	78.7	—	—	22	490
—	444	472	74.2	—	47.1	60.8	63	1585	137	137	143	—	76.4	—	—	21	460
—	—	474	74.3	—	47.2	61.0	—	1595	131	131	137	—	74.0	—	—	—	450
—	—	472	74.2	—	47.1	60.8	—	1585	126	126	132	—	72.0	—	—	20	435
—	444	472	74.2	—	47.1	60.8	63	1585	121	121	127	—	69.8	—	—	19	415
—	—	472	74.2	—	47.1	60.8	—	1585	116	116	122	—	67.6	—	—	18	400
—	—	472	74.2	—	47.1	60.8	63	1585	111	111	117	—	65.7	—	—	15	385

Note 1) The above list is the same as that of AMS Metals Hand book with tensile strength in approximate metric value and Brinell hardness over a recommended range.

Note 2) 1MPa=1N/mm²

Note 3) Figures in () are rarely used and are included for reference. This list has been taken from JIS Handbook Steel I.

P

TECHNICAL DATA

FIT TOLERANCE TABLE(HOLE)

Classification of Standard Dimensions (mm)		Class of Geometrical Tolerance Zone of Holes																		
>	≤	B10	C9	C10	D8	D9	D10	E7	E8	E9	F6	F7	F8	G6	G7	H6	H7			
—	3	+180	+85	+100	+34	+45	+60	+24	+28	+39	+12	+16	+20	+8	+12	+6	+10			
		+140	+60	+60	+20	+20	+20	+14	+14	+14	+6	+6	+6	+2	+2	0	0			
3	6	+188	+100	+118	+48	+60	+78	+32	+38	+50	+18	+22	+28	+12	+16	+8	+12			
		+140	+70	+70	+30	+30	+30	+20	+20	+20	+10	+10	+10	+4	+4	0	0			
6	10	+208	+116	+138	+62	+76	+98	+40	+47	+61	+22	+28	+35	+14	+20	+9	+15			
		+150	+80	+80	+40	+40	+40	+25	+25	+25	+13	+13	+13	+5	+5	0	0			
10	14	+220	+138	+165	+77	+93	+120	+50	+59	+75	+27	+34	+43	+17	+24	+11	+18			
		+150	+95	+95	+50	+50	+50	+32	+32	+32	+16	+16	+16	+6	+6	0	0			
14	18	+244	+162	+194	+98	+117	+149	+61	+73	+92	+33	+41	+53	+20	+28	+13	+21			
		+160	+110	+110	+65	+65	+65	+40	+40	+40	+20	+20	+20	+7	+7	0	0			
18	24	+270	+182	+220	+119	+142	+180	+75	+89	+112	+41	+50	+64	+25	+34	+16	+25			
		+170	+120	+120	+80	+80	+80	+50	+50	+50	+25	+25	+25	+9	+9	0	0			
24	30	+280	+192	+230	+146	+174	+220	+90	+106	+134	+49	+60	+76	+29	+40	+19	+30			
		+180	+130	+130	+100	+100	+100	+60	+60	+60	+30	+30	+30	+10	+10	0	0			
30	40	+310	+214	+260	+174	+207	+260	+107	+126	+159	+58	+71	+90	+34	+47	+22	+35			
		+190	+140	+140	+120	+120	+120	+72	+72	+72	+36	+36	+36	+12	+12	0	0			
30	50	+320	+224	+270	+208	+245	+305	+125	+148	+185	+68	+83	+106	+39	+54	+25	+40			
		+200	+150	+150	+145	+145	+145	+85	+85	+85	+43	+43	+43	+14	+14	0	0			
40	50	+360	+257	+310	+470	+330	+390	+242	+285	+355	+146	+172	+215	+79	+96	+122	+44	+61	+29	+46
		+220	+170	+170	+310	+240	+200	+200	+170	+170	+170	+100	+100	+100	+50	+50	+50	+15	+15	0
40	65	+380	+267	+320	+525	+355	+425	+271	+320	+400	+162	+191	+240	+88	+108	+137	+49	+69	+32	+52
		+240	+180	+180	+340	+240	+240	+190	+190	+190	+110	+110	+110	+56	+56	+56	+17	+17	0	0
50	65	+420	+300	+360	+565	+375	+445	+299	+350	+440	+182	+214	+265	+98	+119	+151	+54	+75	+36	+57
		+260	+200	+200	+380	+260	+260	+210	+210	+210	+125	+125	+125	+62	+62	+62	+18	+18	0	0
50	80	+440	+310	+370	+605	+395	+465	+210	+210	+210	+125	+125	+125	+62	+62	+62	+18	+18	0	0
		+280	+210	+210	+420	+280	+280	+270	+320	+400	+162	+191	+240	+88	+108	+137	+49	+69	+32	+52
65	80	+470	+330	+390	+690	+430	+510	+271	+320	+400	+162	+191	+240	+88	+108	+137	+49	+69	+32	+52
		+310	+230	+230	+480	+300	+300	+190	+190	+190	+110	+110	+110	+56	+56	+56	+17	+17	0	0
80	100	+525	+355	+425	+750	+460	+540	+271	+320	+400	+162	+191	+240	+88	+108	+137	+49	+69	+32	+52
		+340	+240	+240	+540	+330	+330	+190	+190	+190	+110	+110	+110	+56	+56	+56	+17	+17	0	0
80	120	+565	+375	+445	+830	+500	+590	+299	+350	+440	+182	+214	+265	+98	+119	+151	+54	+75	+36	+57
		+380	+260	+260	+600	+360	+360	+210	+210	+210	+125	+125	+125	+62	+62	+62	+18	+18	0	0
100	120	+605	+395	+465	+910	+540	+630	+210	+210	+210	+125	+125	+125	+62	+62	+62	+18	+18	0	0
		+420	+280	+280	+680	+400	+400	+210	+210	+210	+125	+125	+125	+62	+62	+62	+18	+18	0	0
120	140	+690	+430	+510	+1010	+595	+690	+327	+385	+480	+198	+232	+290	+108	+131	+165	+60	+83	+40	+63
		+480	+300	+300	+760	+440	+440	+230	+230	+230	+135	+135	+135	+68	+68	+68	+20	+20	0	0
120	160	+750	+460	+540	+1090	+635	+730	+327	+385	+480	+198	+232	+290	+108	+131	+165	+60	+83	+40	+63
		+540	+330	+330	+840	+480	+480	+230	+230	+230	+135	+135	+135	+68	+68	+68	+20	+20	0	0
140	160	+830	+500	+590	+1090	+635	+730	+327	+385	+480	+198	+232	+290	+108	+131	+165	+60	+83	+40	+63
		+600	+360	+360	+840	+480	+480	+230	+230	+230	+135	+135	+135	+68	+68	+68	+20	+20	0	0
140	180	+910	+540	+630	+1100	+640	+740	+330	+390	+490	+200	+235	+295	+110	+135	+170	+65	+85	+45	+65
		+680	+400	+400	+840	+480	+480	+230	+230	+230	+135	+135	+135	+68	+68	+68	+20	+20	0	0
160	180	+1010	+595	+690	+1100	+640	+740	+330	+390	+490	+200	+235	+295	+110	+135	+170	+65	+85	+45	+65
		+760	+440	+440	+840	+480	+480	+230	+230	+230	+135	+135	+135	+68	+68	+68	+20	+20	0	0
160	200	+1090	+635	+730	+1100	+640	+740	+330	+390	+490	+200	+235	+295	+110	+135	+170	+65	+85	+45	+65
		+840	+480	+480	+840	+480	+480	+230	+230	+230	+135	+135	+135	+68	+68	+68	+20	+20	0	0

Note 1) Values shown in the upper portion of the respective boxes are the upper dimensional tolerance, while values shown in the lower portion are the lower dimensional tolerance.

P

TECHNICAL DATA

Class of Geometrical Tolerance Zone of Holes

H8	H9	H10	JS6	JS7	K6	K7	M6	M7	N6	N7	P6	P7	R7	S7	T7	U7	X7
+14 0	+25 0	+40 0	± 3	± 5	0 -6	0 -10	-2 -8	-2 -12	-4 -10	-4 -14	-6 -12	-6 -16	-10 -20	-14 -24	-	-18 -28	-20 -30
+18 0	+30 0	+48 0	± 4	± 6	+2 -6	+3 -9	-1 -9	0 -12	-5 -13	-4 -16	-9 -17	-8 -20	-11 -23	-15 -27	-	-19 -31	-24 -36
+22 0	+36 0	+58 0	± 4.5	± 7	+2 -7	+5 -10	-3 -12	0 -15	-7 -16	-4 -19	-12 -21	-9 -24	-13 -28	-17 -32	-	-22 -37	-28 -43
+27 0	+43 0	+70 0	± 5.5	± 9	+2 -9	+6 -12	-4 -15	0 -18	-9 -20	-5 -23	-15 -26	-11 -29	-16 -34	-21 -39	-	-26 -44	-33 -51 -56
+33 0	+52 0	+84 0	± 6.5	± 10	+2 -11	+6 -15	-4 -17	0 -21	-11 -24	-7 -28	-18 -31	-14 -35	-20 -41	-27 -48	-	-33 -54	-46 -67 -77
+39 0	+62 0	+100 0	± 8	± 12	+3 -13	+7 -18	-4 -20	0 -25	-12 -28	-8 -33	-21 -37	-17 -42	-25 -50	-34 -59	-	-39 -64 -76	-51 -76
+46 0	+74 0	+120 0	± 9.5	± 15	+4 -15	+9 -21	-5 -24	0 -30	-14 -33	-9 -39	-26 -45	-21 -51	-30 -60 -62	-42 -72 -78	-55 -85 -94	-76 -106 -121	-
+54 0	+87 0	+140 0	± 11	± 17	+4 -18	+10 -25	-6 -28	0 -35	-16 -38	-10 -45	-30 -52	-24 -59	-38 -73 -76	-58 -93 -101	-78 -113 -126	-111 -146 -166	-
+63 0	+100 0	+160 0	± 12.5	± 20	+4 -21	+12 -28	-8 -33	0 -40	-20 -45	-12 -52	-36 -61	-28 -68	-48 -88 -90 -93	-77 -117 -125 -133	-107 -147 -159 -171	-	-
+72 0	+115 0	+185 0	± 14.5	± 23	+5 -24	+13 -33	-8 -37	0 -46	-22 -51	-14 -60	-41 -70	-33 -79	-60 -105 -106	-113 -159 -123 -169	-	-	-
+81 0	+130 0	+210 0	± 16	± 26	+5 -27	+16 -36	-9 -41	0 -52	-25 -57	-14 -66	-47 -79	-36 -88	-74 -126 -78 -130	-	-	-	-
+89 0	+140 0	+230 0	± 18	± 28	+7 -29	+17 -40	-10 -46	0 -57	-26 -62	-16 -73	-51 -87	-41 -98	-87 -144 -93 -150	-	-	-	-
+97 0	+155 0	+250 0	± 20	± 31	+8 -32	+18 -45	-10 -50	0 -63	-27 -67	-17 -80	-55 -95	-45 -108	-103 -166 -109 -172	-	-	-	-

FIT TOLERANCE TABLE(SHAFT)

Classification of Standard Dimensions (mm)		Class of Geometrical Tolerance Zone of Shafts														
>	≤	b9	c9	d8	d9	e7	e8	e9	f6	f7	f8	g5	g6	h5	h6	h7
—	3	−140	−60	−20	−20	−14	−14	−14	−6	−6	−6	−2	−2	0	0	0
		−165	−85	−34	−45	−24	−28	−39	−12	−16	−20	−6	−8	−4	−6	−10
3	6	−140	−70	−30	−30	−20	−20	−20	−10	−10	−10	−4	−4	0	0	0
		−170	−100	−48	−60	−32	−38	−50	−18	−22	−28	−9	−12	−5	−8	−12
6	10	−150	−80	−40	−40	−25	−25	−25	−13	−13	−13	−5	−5	0	0	0
		−186	−116	−62	−76	−40	−47	−61	−22	−28	−35	−11	−14	−6	−9	−15
10	14	−150	−95	−50	−50	−32	−32	−32	−16	−16	−16	−6	−6	0	0	0
		−193	−138	−77	−93	−50	−59	−75	−27	−34	−43	−14	−17	−8	−11	−18
18	24	−160	−110	−65	−65	−40	−40	−40	−20	−20	−20	−7	−7	0	0	0
		−212	−162	−98	−117	−61	−73	−92	−33	−41	−53	−16	−20	−9	−13	−21
30	40	−170	−120	−80	−80	−50	−50	−50	−25	−25	−25	−9	−9	0	0	0
		−232	−182													
40	50	−180	−130	−119	−142	−75	−89	−112	−41	−50	−64	−20	−25	−11	−16	−25
		−242	−192													
50	65	−190	−140	−100	−100	−60	−60	−60	−30	−30	−30	−10	−10	0	0	0
		−264	−214													
65	80	−200	−150	−146	−174	−90	−106	−134	−49	−60	−76	−23	−29	−13	−19	−30
		−274	−224													
80	100	−220	−170	−120	−120	−72	−72	−72	−36	−36	−36	−12	−12	0	0	0
		−307	−257													
100	120	−240	−180	−174	−207	−107	−126	−159	−58	−71	−90	−27	−34	−15	−22	−35
		−327	−267													
120	140	−260	−200	−145	−145	−85	−85	−85	−43	−43	−43	−14	−14	0	0	0
		−360	−300													
140	160	−280	−210	−208	−245	−125	−148	−185	−68	−83	−106	−32	−39	−18	−25	−40
		−380	−310													
160	180	−310	−230	−145	−145	−85	−85	−85	−43	−43	−43	−14	−14	0	0	0
		−410	−330													
180	200	−340	−240	−170	−170	−100	−100	−100	−50	−50	−50	−15	−15	0	0	0
		−455	−355													
200	225	−380	−260	−242	−285	−146	−172	−215	−79	−96	−122	−35	−44	−20	−29	−46
		−495	−375													
225	250	−420	−280	−170	−170	−100	−100	−100	−50	−50	−50	−15	−15	0	0	0
		−535	−395													
250	280	−480	−300	−190	−190	−110	−110	−110	−56	−56	−56	−17	−17	0	0	0
		−610	−430													
280	315	−540	−330	−271	−320	−162	−191	−240	−88	−108	−137	−40	−49	−23	−32	−52
		−670	−460													
315	355	−600	−360	−210	−210	−125	−125	−125	−62	−62	−62	−18	−18	0	0	0
		−740	−500													
355	400	−680	−400	−299	−350	−182	−214	−265	−98	−119	−151	−43	−54	−25	−36	−57
		−820	−540													
400	450	−760	−440	−230	−230	−135	−135	−135	−68	−68	−68	−20	−20	0	0	0
		−915	−595													
450	500	−840	−480	−327	−385	−198	−232	−290	−108	−131	−165	−47	−60	−27	−40	−63
		−995	−635													

Note 1) Values shown in the upper portion of the respective boxes are the upper dimensional tolerance, while values shown in the lower portion are the lower dimensional tolerance.

P

TECHNICAL DATA

Class of Geometrical Tolerance Zone of Shafts

h8	h9	js5	js6	js7	k5	k6	m5	m6	n6	p6	r6	s6	t6	u6	x6
0 -14	0 -25	± 2	± 3	± 5	+4 0	+6 0	+6 +2	+8 +2	+10 +4	+12 +6	+16 +10	+20 +14	—	+24 +18	+26 +20
0 -18	0 -30	± 2.5	± 4	± 6	+6 +1	+9 +1	+9 +4	+12 +4	+16 +8	+20 +12	+23 +15	+27 +19	—	+31 +23	+36 +28
0 -22	0 -36	± 3	± 4.5	± 7	+7 +1	+10 +1	+12 +6	+15 +6	+19 +10	+24 +15	+28 +19	+32 +23	—	+37 +28	+43 +34
0 -27	0 -43	± 4	± 5.5	± 9	+9 +1	+12 +1	+15 +7	+18 +7	+23 +12	+29 +18	+34 +23	+39 +28	—	+44 +33	+51 +40 +56 +45
0 -33	0 -52	± 4.5	± 6.5	± 10	+11 +2	+15 +2	+17 +8	+21 +8	+28 +15	+35 +22	+41 +28	+48 +35	— +54 +41	+54 +61 +48	+67 +54 +77 +64
0 -39	0 -62	± 5.5	± 8	± 12	+13 +2	+18 +2	+20 +9	+25 +9	+33 +17	+42 +26	+50 +34	+59 +43	+64 +48 +70 +54	+76 +60 +86 +70	—
0 -46	0 -74	± 6.5	± 9.5	± 15	+15 +2	+21 +2	+24 +11	+30 +11	+39 +20	+51 +32	+60 +41 +62 +43	+72 +53 +78 +59	+85 +66 +94 +75	+106 +87 +121 +102	—
0 -54	0 -87	± 7.5	± 11	± 17	+18 +3	+25 +3	+28 +13	+35 +13	+45 +23	+59 +37	+73 +51 +76 +54	+93 +71 +101 +79	+113 +91 +126 +104	+146 +124 +166 +144	—
0 -63	0 -100	± 9	± 12.5	± 20	+21 +3	+28 +3	+33 +15	+40 +15	+52 +27	+68 +43	+88 +63 +90 +65 +93 +68	+117 +92 +125 +100 +133 +108	+147 +122 +159 +134 +171 +146	—	—
0 -72	0 -115	± 10	± 14.5	± 23	+24 +4	+33 +4	+37 +17	+46 +17	+60 +31	+79 +50	+106 +77 +109 +80 +113 +84	+151 +122 +159 +130 +169 +140	—	—	—
0 -81	0 -130	± 11.5	± 16	± 26	+27 +4	+36 +4	+43 +20	+52 +20	+66 +34	+88 +56	+126 +94 +130 +98	—	—	—	—
0 -89	0 -140	± 12.5	± 18	± 28	+29 +4	+40 +4	+46 +21	+57 +21	+73 +37	+98 +62	+144 +108 +150 +114	—	—	—	—
0 -97	0 -155	± 13.5	± 20	± 31	+32 +5	+45 +5	+50 +23	+63 +23	+80 +40	+108 +68	+166 +126 +172 +132	—	—	—	—

INTERNATIONAL SYSTEM OF UNITS

UNIT CONVERSION TABLE for EASIER CHANGE into SI UNITS
(Bold type Indicates SI unit)

● **Pressure**

Pa	kPa	MPa	bar	kgf/cm ²	atm	mmH ₂ O	mmHg or Torr
1	1×10 ⁻³	1×10 ⁻⁶	1×10 ⁻⁵	1.01972×10 ⁻⁵	9.86923×10 ⁻⁶	1.01972×10 ⁻¹	7.50062×10 ⁻³
1×10 ³	1	1×10 ⁻³	1×10 ⁻²	1.01972×10 ⁻²	9.86923×10 ⁻³	1.01972×10 ²	7.50062
1×10 ⁶	1×10 ³	1	1×10	1.01972×10	9.86923	1.01972×10 ⁵	7.50062×10 ³
1×10 ⁵	1×10 ²	1×10 ⁻¹	1	1.01972	9.86923×10 ⁻¹	1.01972×10 ⁴	7.50062×10 ²
9.80665×10 ⁴	9.80665×10	9.80665×10 ⁻²	9.80665×10 ⁻¹	1	9.67841×10 ⁻¹	1×10 ⁴	7.35559×10 ²
1.01325×10 ⁵	1.01325×10 ²	1.01325×10 ⁻¹	1.01325	1.03323	1	1.03323×10 ⁴	7.60000×10 ²
9.80665	9.80665×10 ⁻³	9.80665×10 ⁻⁶	9.80665×10 ⁻⁵	1×10 ⁻⁴	9.67841×10 ⁻⁵	1	7.35559×10 ⁻²
1.33322×10 ²	1.33322×10 ⁻¹	1.33322×10 ⁻⁴	1.33322×10 ⁻³	1.35951×10 ⁻³	1.31579×10 ⁻³	1.35951×10	1

Note 1) 1Pa=1N/m²

● **Force**

N	dyn	kgf
1	1×10 ⁵	1.01972×10 ⁻¹
1×10 ⁻⁵	1	1.01972×10 ⁻⁶
9.80665	9.80665×10 ⁵	1

● **Stress**

Pa	MPa or N/mm ²	kgf/mm ²	kgf/cm ²
1	1×10 ⁻⁶	1.01972×10 ⁻⁷	1.01972×10 ⁻⁵
1×10 ⁶	1	1.01972×10 ⁻¹	1.01972×10
9.80665×10 ⁶	9.80665	1	1×10 ²
9.80665×10 ⁴	9.80665×10 ⁻²	1×10 ⁻²	1

Note 1) 1Pa=1N/m²

● **Work / Energy / Quantity of Heat**

J	kW·h	kgf·m	kcal
1	2.77778×10 ⁻⁷	1.01972×10 ⁻¹	2.38889×10 ⁻⁴
3.600 ×10 ⁶	1	3.67098×10 ⁵	8.6000 ×10 ²
9.80665	2.72407×10 ⁻⁶	1	2.34270×10 ⁻³
4.18605×10 ³	1.16279×10 ⁻³	4.26858×10 ²	1

Note 1) 1J=1W·s, 1J=1N·m
1cal=4.18605J
(By the law of weights and measures)











● **Power (Rate of Production / Motive Power) /Heat Flow Rate**

W	kgf·m/s	PS	kcal/h
1	1.01972×10 ⁻¹	1.35962×10 ⁻³	8.6000 ×10 ⁻¹
9.80665	1	1.33333×10 ⁻²	8.43371
7.355 ×10 ²	7.5 ×10	1	6.32529×10 ²
1.16279	1.18572×10 ⁻¹	1.58095×10 ⁻³	1

Note 1) 1W=1J/s, PS:French horse power
1PS=0.7355kW
1cal=4.18605J
(By the law of weights and measures)

TOOL WEAR AND DAMAGE

CAUSES AND COUNTERMEASURES

Tool Damage Form	Cause	Countermeasure
Flank Wear 	<ul style="list-style-type: none"> • Tool grade is too soft. • Cutting speed is too high. • Flank angle is too small. • Feed rate is extremely low. 	<ul style="list-style-type: none"> • Tool grade with high wear resistance. • Lower cutting speed. • Increase flank angle. • Increase feed rate.
Crater Wear 	<ul style="list-style-type: none"> • Tool grade is too soft. • Cutting speed is too high. • Feed rate is too high. 	<ul style="list-style-type: none"> • Tool grade with high wear resistance. • Lower cutting speed. • Lower feed rate.
Chipping 	<ul style="list-style-type: none"> • Tool grade is too hard. • Feed rate is too high. • Lack of cutting edge strength. • Lack of shank or holder rigidity. 	<ul style="list-style-type: none"> • Tool grade with high toughness. • Lower feed rate. • Increase honing. (Round honing is to be changed to chamfer honing.) • Use large shank size.
Fracture 	<ul style="list-style-type: none"> • Tool grade is too hard. • Feed rate is too high. • Lack of cutting edge strength. • Lack of shank or holder rigidity. 	<ul style="list-style-type: none"> • Tool grade with high toughness. • Lower feed rate. • Increase honing. (Round honing is to be changed to chamfer honing.) • Use large shank size.
Plastic Deformation 	<ul style="list-style-type: none"> • Tool grade is too soft. • Cutting speed is too high. • Depth of cut and feed rate are too large. • Cutting temperature is high. 	<ul style="list-style-type: none"> • Tool grade with high wear resistance. • Lower cutting speed. • Decrease depth of cut and feed rate. • Tool grade with high thermal conductivity.
Welding 	<ul style="list-style-type: none"> • Cutting speed is low. • Poor sharpness. • Unsuitable grade. 	<ul style="list-style-type: none"> • Increase cutting speed. (For DIN Ck45, cutting speed 80m/min.) • Increase rake angle. • Tool grade with low affinity. (Coated grade, cermet grade)
Thermal Cracks 	<ul style="list-style-type: none"> • Expansion or shrinkage due to cutting heat. • Tool grade is too hard. • *Especially in milling. 	<ul style="list-style-type: none"> • Dry cutting. (For wet cutting, flood workpiece with cutting fluid) • Tool grade with high toughness.
Notching 	<ul style="list-style-type: none"> • Hard surfaces such as uncut surfaces, chilled parts and machining hardened layers. • Friction caused by jagged shape chips. (Caused by small vibration) 	<ul style="list-style-type: none"> • Tool grade with high wear resistance. • Increase rake angle to improve sharpness.
Flaking 	<ul style="list-style-type: none"> • Cutting edge welding and adhesion. • Poor chip disposal. 	<ul style="list-style-type: none"> • Increase rake angle to improve sharpness. • Enlarge chip pocket.
Flank Wear Fracture *Damage for polycrystallines 	<ul style="list-style-type: none"> • Damage due to the lack of strength of a curved cutting edge. 	<ul style="list-style-type: none"> • Increase honing. • Tool grade with high toughness.
Crater Wear Fracture *Damage for polycrystallines 	<ul style="list-style-type: none"> • Tool grade is too soft. • Cutting resistance is too high and causes high cutting heat. 	<ul style="list-style-type: none"> • Decrease honing. • Tool grade with high wear resistance.

CUTTING TOOL MATERIALS

Cemented carbide (WC-Co) was developed in 1923 and was later improved by adding TiC and TaC. In 1969, CVD coating technology was developed, and coated carbide has since been used widely. TiC-TiN based cermet was developed in 1974. Today, "Coated Carbide grades for roughing and cermet for finishing" is a well established trend.

TECHNICAL DATA

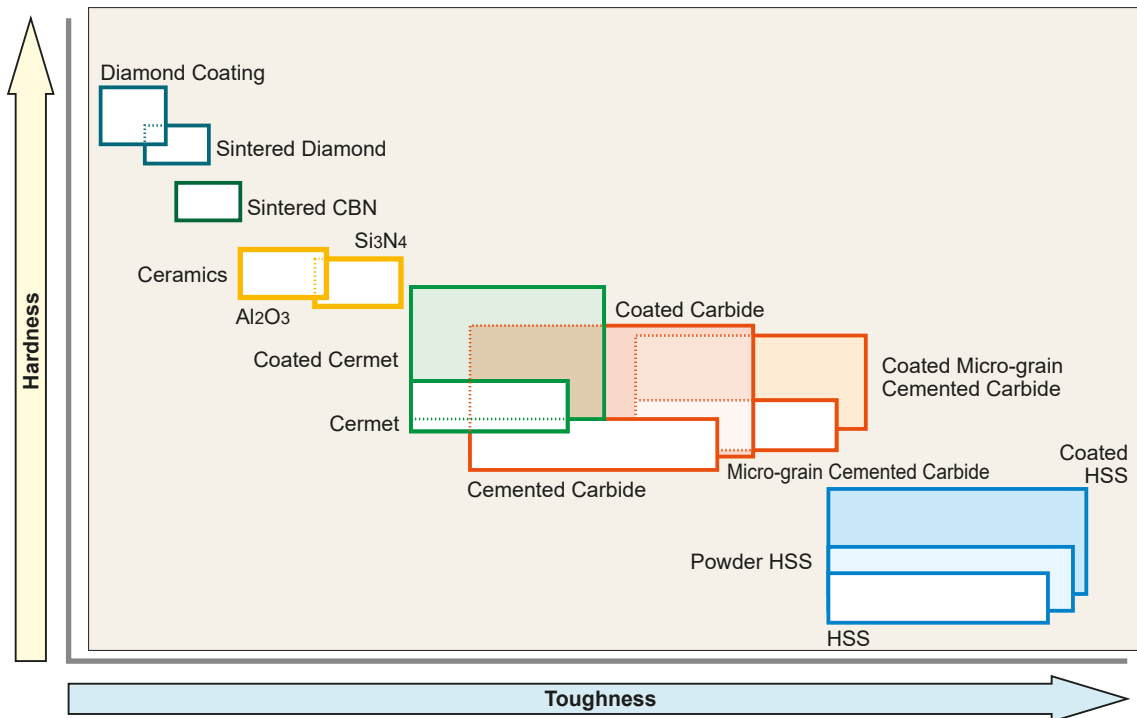

GRADE CHARACTERISTICS

Hard Materials	Hardness (HV)	Energy Formation (kcal/g·atom)	Solubility in Iron (%.1250°C)	Thermal Conductivity (W/m·k)	Thermal * Expansion (x 10 ⁻⁶ /k)	Tool Material
Diamond	>9000	–	Highly Soluble	2100	3.1	Sintered Diamond
CBN	>4500	–	–	1300	4.7	Sintered CBN
Si ₃ N ₄	1600	–	–	100	3.4	Ceramics
Al ₂ O ₃	2100	-100	≠0	29	7.8	Ceramics Cemented Carbide
TiC	3200	-35	< 0.5	21	7.4	Cermet Coated Carbide
TiN	2500	-50	–	29	9.4	Cermet Coated Carbide
TaC	1800	-40	0.5	21	6.3	Cemented Carbide
WC	2100	-10	7	121	5.2	Cemented Carbide

*1W/m·K=2.39×10⁻³cal/cm·sec·°C

GRADE CHAIN

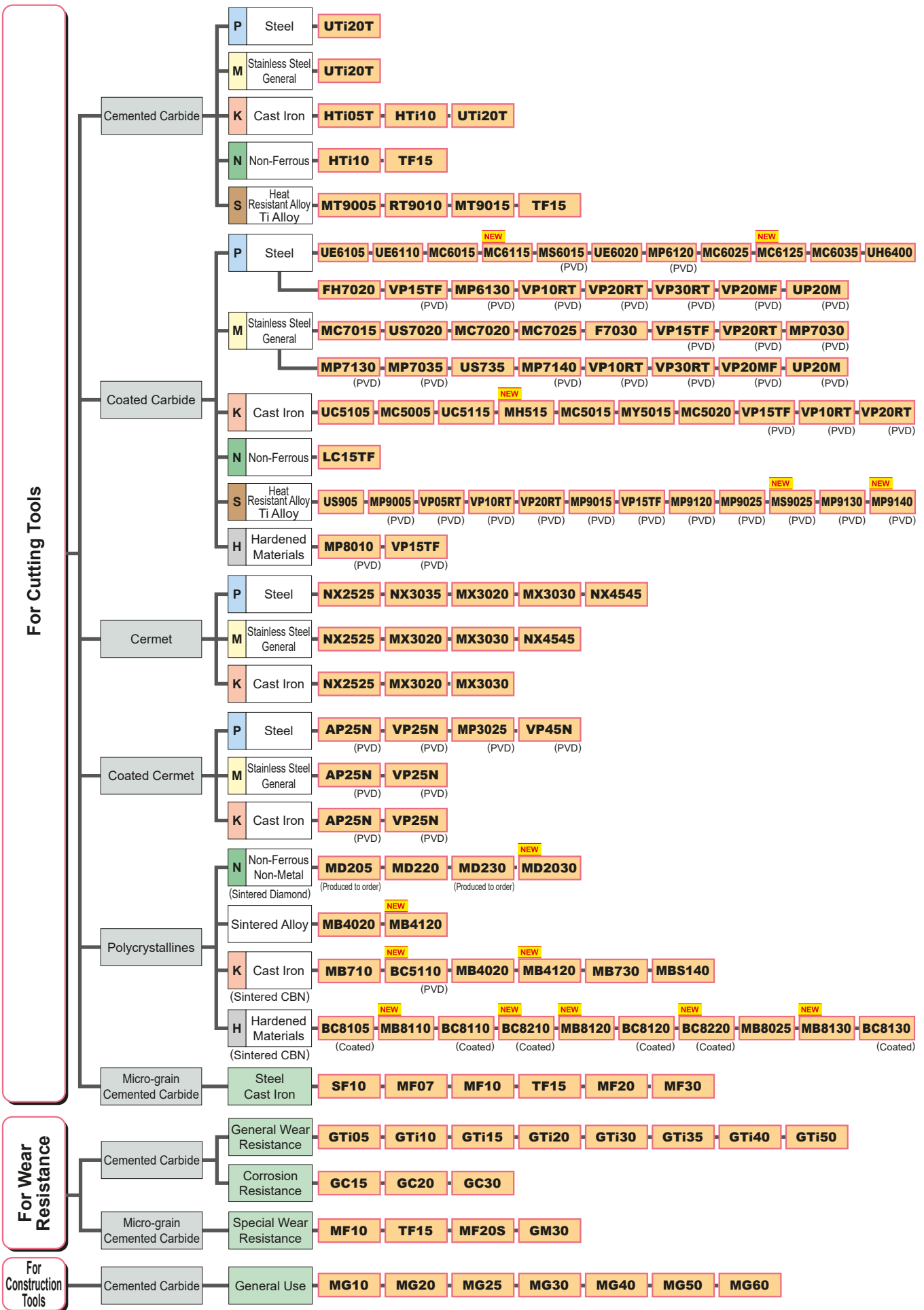

TECHNICAL DATA

GRADES COMPARISON TABLE

CEMENTED CARBIDE

Classification	ISO	Mitsubishi Materials	Sandvik	Kennametal	Seco Tools	Iscar	Sumitomo Electric	Tungaloy	Kyocera	Dijet	MOLDINO	
	Symbol											
Turning	P	P01										
		P10				IC70	ST10P	TH10			WS10	
		P20	UTi20T				IC70 IC50M	ST20E	KS20			EX35
		P30	UTi20T				IC50M IC54	A30 A30N	UX30 KS15F			EX35
		P40					IC54	ST40E	TX40			EX35
	M	M10			KU10 K313 K68	890	IC07	EH510	TH10			WA10B
		M20	UTi20T		KU10 K313 K68	HX 883	IC07 IC08 IC20	EH520	KS20			EX35
		M30	UTi20T				IC08 IC20 IC28	A30 A30N	UX30			EX35
		M40					IC28		TU40			
	K	K01	HTi05T		KU10 K313 K68			H1 H2	KS05F			WH01 WH05
		K10	HTi10		KU10 K313 K68	890	IC20	EH510	TH10	KW10 GW15	KT9	WH10
		K20	UTi20T	H13A	KU10 K313 K68	HX	IC20	G10E H10E EH520	KS15F KS20	GW25	KT9	WH20
		K30	UTi20T			883		G10E H10E				
	N	N01		H10				H1 H2	KS05F	GW05 KW10		
		N10	HTi10	H10 HBA	KU10 K313 K68	890	IC08 IC20	EH510	TH10	KW10 GW15	KT9	WH10
		N20		H10 HBA	KU10 K313 K68	HX KX	IC08 IC20	G10E EH520	KS15F		KT9	WH20
		N30				883						
	S	S01	MT9005							SW05		
		S10	MT9005 RT9010 MT9015	H10A H10F H13A	KU10 K313 K68	HX 883	IC07 IC08	EH510	KS05F TH10	SW10		WH13S
		S20	RT9010 TF15		KU10 K313 K68	883	IC07 IC08	EH520	KS15F KS20	SW25		
S30		TF15										
Milling	P	P10										
		P20	UTi20T		K125M		IC50M IC28	A30N				EX35
		P30	UTi20T	SM30	GX		IC50M IC28	A30N	UX30			EX35
		P40					IC28					EX35
	M	M10										
		M20	UTi20T				IC08 IC20	A30N				EX35
		M30	UTi20T	SM30			IC08 IC28	A30N				EX35
		M40					IC28					
	K	K01	HTi05T		K115M,K313							
		K10	HTi10		K115M K313		IC20	G10E	TH10	KW10 GW25	KT9	WH10
		K20	UTi20T	H13A		HX	IC20	G10E		GW25	FZ15	WH20
		K30	UTi20T									

Note 1) The tables above are based on published data and not authorized by each manufacturer.

TECHNICAL DATA

P

MICRO GRAIN

Classification	ISO	Mitsubishi	Sandvik	Kennametal	Seco	Sumitomo	Tungaloy	Kyocera	Dijet	MOLDINO	
	Symbol	Materials			Tools	Electric					
Cutting Tools	Z	Z01	SF10 MF07 MF10	PN90 6UF,H3F 8UF,H6F			F0	F MD05F MD1508		FZ05 FB05 FB10	NM08
		Z10	HTi10 MF20	H10F		890	XF1 F1 AFU	MD10 MD0508 MD07F	FW30	FZ10 FZ15 FB15	NM10 NM12 NM15
		Z20	TF15 MF30	H15F		890 883	AF0 SF2 AF1	EM10 MD20 G1F		FZ15 FB15 FB20	BRM20 EF20N
		Z30				883	A1 CC			FZ20 FB20	NM25 NM40

CERMET

Classification	ISO	Mitsubishi	Sandvik	Kennametal	Seco	Iscar	Sumitomo	Tungaloy	Kyocera	Dijet	MOLDINO		
	Symbol	Materials			Tools		Electric						
Turning	P	P01	AP25N* VP25N*				IC20N IC520N*	T1000A	NS520 GT720*		CCX* TN610 PV710* PV30*		
		P10	NX2525 AP25N* VP25N*	CT5015 GC1525*	KT315 KT125	TP1020 TP1030* CM CMP*	IC20N IC520N* IC530N*	T1500A T1500Z*	NS520 NS9530 GT9530* AT9530*		CX75	CZ25*	
		P20	NX2525 AP25N* VP25N* NX3035 MP3025*	GC1525*	KT325 KT1120 KT5020*	TP1020 TP1030*	IC20N IC520N* IC30N IC530N* IC75T	T1500A T1500Z* T2500A T2500Z* T3000Z*		NS9530 GT9530* AT9530*	TN60 TN620 PV720* TN6020	CX75 PX90*	CH550
		P30	MP3025* VP45N*				IC75T	T3000Z*		PV730* PV90*	PX90*		
	M	M10	NX2525 AP25N* VP25N*	GC1525*	KT125	TP1020 TP1030* CM CMP*		T1000A T1500Z*		TN60 TN620 PV720* TN6020			CZ25*
		M20	NX2525 AP25N* VP25N*					T1500A T1500Z*		TN90 TN6020 TN620 PV720* PV90*			CH550
		M30								PV730*			
	K	K01	NX2525 AP25N*					T1000A	NS520 GT720*	CCX* PV7005*			
		K10	NX2525 AP25N*	CT5015	KT325 KT125				NS520 NS9530 GT9530*	CCX* PV7005* TN60			CZ25*
		K20	NX2525 AP25N*										CH550
Milling	P	P10	NX2525			C15M	IC30N			TN620M TN60	CX75	MZ1000*	
		P20	MX3020 NX2525	CT530	KT530M HT7 KT605M	C15M MP1020	IC30N	T250A T2500A		TN100M TN620M TN60	CX75 CX90	CH550 CH7030 MZ1000*	
		P30	MX3030 NX4545				IC30N	T4500A	NS740		CX90	CH7035	
	M	M10	NX2525					IC30N			TN60		
		M20	MX3020 NX2525	CT530	KT530M HT7 KT605M	C15M	IC30N	T250A T2500A			TN100M	CX75	
		M30	MX3030 NX4545					T4500A					
	K	K01											
		K10	NX2525								TN60	CX75	
		K20	NX2525		KT530M HT7							CX75	

*Coated Cermet

Note 1) The tables above are based on published data and not authorized by each manufacturer.

P

TECHNICAL DATA

GRADES COMPARISON TABLE

CVD COATED GRADE

Classification	ISO	Mitsubishi Materials	Sandvik	Kennametal	Seco Tools	Iscar	Sumitomo Electric	Tungaloy	Kyocera	Dijet	MOLDINO		
	Symbol												
P	Turning	P01	MC6115 UE6105	GC4305 GC4205 GC4415	KCP05B KCP05 KC9105	TP0501 TP0500 TP1501 TP1500	IC9150 IC8150 IC428	AC810P AC700G	T9105 T9025	CA510 CA5505	JC110V	HG8010	
		P10	MC6115 UE6105 MC6015 UE6110 MY5015	GC4315 GC4215 GC4325 GC4415	KCP10B KCP10 KCP25 KC9110	TP1501 TP1500 TP2501 TP2500	IC9150 IC8150 IC8250	AC810P AC700G AC820P AC2000 AC8015P	T9105 T9115 T9215	CA510 CA5505 CA515 CA5515	JC110V JC215V	HG8010 HG8025 GM8020	
		P20	MC6115 MC6015 UE6110 MC6125 MC6025 UE6020 MY5015	GC4315 GC4215 GC4325 GC4425	KCP25B KCP30B KCP25 KC9125	TP2501 TP2500	IC8250 IC9250 IC8350	AC820P AC2000 AC8025P AC830P	T9115 T9125 T9215 T9225	CA025P CA515 CA5515 CA525 CA5525 CR9025	JC110V JC215V	HG8025 GM8020 GM25	
		P30	MC6125 MC6025 UE6020 MC6035 UH6400	GC4325 GC4335 GC4225 GC4235 GC4425	KCP30B KCP30	TP3501 TP3500 TP3000	IC8350 IC9250 IC9350	AC8035P AC830P AC630M	T9125 T9135 T9225 T9235	CA025P CA525 CA5525 CA530 CA5535 CR9025	JC215V JC325V	GM25 GM8035	
		P40	MC6035 UH6400	GC4235 GC4335	KCP40 KCP40B KC9140 KC9240	TP3501 TP3500 TP3000	IC9350	AC8035P AC630M	T9135 T9035 T9235	CA530 CA5535	JC325V	GM8035 GX30	
	M10	MC7015 US7020	GC2015 GC2220	KCM15B KCM15	TM1501 TM2000	IC6015 IC8250	AC610M AC6020M	T6120 T9215	CA6515	JX605X JC110V			
	M20	MC7015 US7020 MC7025	GC2015 GC2220	KCM15 KCM25B KCP40B	TM2000 TM2501	IC6015	AC6020M AC610M AC6030M AC630M	T6120 T9215	CA6515 CA6525	JC110V	HG8025 GM25		
	M30	MC7025 US735	GC2025	KCM25 KCM35B KCP40	TM4000 TM3501	IC6025	AC6030M AC630M	T6130	CA6525	JX525X	GM8035 GX30		
	M40	US735	GC2025	KCM35B KCM35	TM4000 TM3501	IC6025	AC6030M AC630M			JX525X	GX30		
	K01	MC5005 UC5105	GC3205 GC3210	KCK05B KCK05	TK0501 TH1500	IC5005	AC405K AC410K AC4010K	T505 T515 T5105	CA4505 CA4010 CA310	JC050W JC105V	HX3505		
	K10	MC5015 MH515 UC5115 MY5015	GC3205 GC3210	KCK15B KCK15 KCK20 KC9315 KCK20B	TK0501 TK1501	IC5005 IC5010 IC428	AC405K AC4010K AC410K AC4015K AC415K	T515 T5115	CA315 CA4515 CA4010 CA4115	JC108W JC050W JC105V JC110V	HX3515 HG8010		
	K20	MC5015 MH515 UC5115 UE6110 MY5015	GC3225	KCK20B KCK20 KCPK05	TK1501	IC5010 IC8150	AC4015K AC415K AC420K AC8025P	T5115 T5125	CA320 CA4515 CA4115 CA4120	JC108W JC110V JC215V	HG8025 GM8020		
	K30	UE6110	GC3225	KCPK05			AC8025P	T5125		JC215	HG8025 GM8020		
	S01	US905	S05F S205						CA6515 CA6525 CA6535		HS9105 HS9115		
	Milling	P	P10			MP1501	IC5400	ACP2000 XCU2500 ACP100			JC730U		
			P20	F7030 MC7020	GC4220	MP1501 MP2501 T25M	IC5500	ACP2000 ACP3000 XCU2500 ACP100	T3130 T3225		JC730U JC835S	GX2140 GF30	
			P30	F7030 MC7020	GC4330 GC4230	KCPK30 KC930M	MP1501 MP2501 TM25 T350	IC5500	ACP3000 XCU2500 ACP100	T3130 T3225		JC835S JC730U	GX2140 GX2160 GF30
			P40		GC4340 GC4240	KC935M KC530M	MM4500 T350M						GX2030 GX2160
		M	M10						XCU2500			JC730U	
			M20	F7030 MC7020		KC925M	MP2501 MS2500 T25M T350M		ACP100 ACM200 XCU2500	T3130 T3225	CA6535	JC730U JC835S	AX2040 GX2140
M30			F7030 FC7020 MC7020	GC2040	KC930M	MP2501 T25M T350M		ACP100 XCU2500 ACM200	T3130 T3225	CA6535	JC730U JC835S	AX2040 GX2140 GX2160 GX30	
M40					KC930M KC935M	MM4500 T350M						GX2160	
K		K01											
		K10	MC5020					XCK2000 ACK200	T1215 T1115	CA420M	JC605W	GX2120	
		K20	MC5020	GC3220 GC3330 K20W	KC915M	MP1501	IC5100	ACK200 XCK2500 XCK2000 ACK200	T1115		JC610 JC605W JC608X	GX2120	
		K30		GC3330 GC3040	KC920M KC925M KCPK30 KC930M KC935M	MP1501	IC5100 DT7150				JC610		

TECHNICAL DATA

P

Note 1) The tables above are based on published data and not authorized by each manufacturer.

PVD COATED GRADE

Classification	ISO	Mitsubishi	Sandvik	Kennametal	Seco	Iscar	Sumitomo	Tungaloy	Kyocera	Dijet	MOLDINO	
	Symbol	Materials			Tools		Electric					
Turning	P	P01							PR1005			
		P10	VP10MF MS6015	GC1125	KCU10 KC5010 KC5510 KU10T	CP200 TS2000	IC250 IC507 IC570 IC807 IC907 IC908		AH710 SH725	PR1005 PR1705 PR930 PR1025 PR1115 PR1225 PR1425 PR1725		
		P20	VP10RT VP20RT VP15TF VP20MF MS6015	GC1125 GC15	KCU10 KC5025 KC5525 KU25T	TS2500	IC1007 IC250 IC308 IC507 IC807 IC808 IC907 IC908 IC1008 IC1028 IC3028		AH710 AH725 AH120 SH730 GH730 GH130 SH725	PR930 PR1025 PR1725 PR1115 PR1225 PR1425 PR1535	IP2000	
		P30	VP10RT VP20RT VP15TF VP20MF	GC1125	KCU25 KC5525 KU25T	CP500	IC228 IC250 IC328 IC330 IC354 IC528 IC1008 IC1028 IC3028		AH725 AH120 SH730 GH730 GH130 AH740 J740 SH725 AH7025	PR1025 PR1725 PR1225 PR1425 PR1535 PR1625	IP3000	
		P40				CP500 CP600	IC228 IC328 IC528 IC928 IC1008 IC1028 IC3028		AH740 J740	PR1535		
	M	M01										
		M10	VP10MF MS6015	GC1115 GC15 GC1105	KCU10 KC5010 KC5510	CP200 TS2000	IC354 IC507 IC520 IC807 IC907 IC1007 IC5080T		AC8005 AH710 SH725	PR1025 PR1225 PR1425 PR1725	JC5003 JC8015	IP050S
		M20	VP10RT VP20RT VP15TF VP20MF MS9025	GC1115 GC15 GC1125	KCU10 KC5010 KC5510	TS2500 CP500	IC354 IC808 IC908 IC1008 IC1028 IC3028 IC5080T	AC520U AC5015S	AH710 AH725 AH120 SH730 GH730 GH130 GH330 AH630 SH725 AH8015 AH7025	PR1025 PR1125 PR1225 PR1425 PR915 PR930 PR1535 PR1725	JC5003 JC5015 JC8015 JC5118	IP100S
		M30	VP10RT VP20RT VP15TF VP20MF MP7035	GC1125 GC2035	KCU25 KC5525	CP500 CP600 TTP2050	IC228 IC250 IC328 IC330 IC1008 IC1028 IC9080T	AC520U AC530U AC1030U AC6040M AC5025S	GH330 AH725 AH120 SH730 GH730 GH130 J740 AH645 SH725	PR1125 PR1725 PR1425 PR1535	JC5015 JC8015 JC5118	
		M40	MP7035	GC2035			IC328 IC928 IC1008 IC1028 IC3028 IC9080T	AC530U AC6040M	J740	PR1535	JC5118	
	K	K01										
		K10		GC15	KCU10 KC5010 KC5510	CP200 TS2000	IC350 IC910 IC1008	AC510U	GH110 AH110 AH710			
		K20	VP10RT VP20RT VP15TF		KCU15 KCU25	CP200 TS2000 TS2500	IC228 IC350 IC808 IC830 IC908 IC1007 IC1008		GH110 AH7025 AH110 AH710 AH725 AH120 GH730 GH130			
		K30	VP10RT VP20RT VP15TF		KCU25 KC5525	CP500	IC228 IC350 IC808 IC830 IC908 IC928 IC1007 IC1008		AH725 AH120 GH730 GH130			
	S	S01	MP9005 VP05RT			TH1000	IC507 IC804 IC807 IC907 IC5080T	AC5005S	AH905 AH8005	PR005S PR1305	JC5003 JC8015	JP9105
		S10	MP9005 MP9015 VP10RT	GC1105 GC15	KCU10 KC5010 KC5410 KC5510	CP200 CP250 TS2000 TS2050 TS2500 TH1000	IC507 IC806 IC807 IC903 IC5080T	AC510U AC5015S	AH905 SH730 AH110 AH8005 AH120	PR005S PR015S PR1310	JC5003 JC5015 JC8015	JP9115
		S20	MP9015 MT9015	GC1125	KCU10 KCU25 KC5025 KC5525	TS2500 CP500	IC228 IC300 IC328 IC808 IC908 IC928 IC3028 IC806 IC9080T	AC510U AC520U AC5025S	AH120 AH725 AH8015	PR015S PR1125 PR1325	JC5015 JC8015 JC5118	
		S30	MS9025 MP9025 VP15TF VP20RT	GC1125	KC5525	CP600	IC928 IC830	AC1030U	AH725 AH7025	PR1125 PR1535	JC5118	
	Milling	P	P01				IC903				JC8003	ATH80D ATH08M TH308 PN208 JP4105 PN15M
			P10		GC1010 GC1130	KC505M KC715M KC510M KC515M		IC250 IC350 IC808 IC810 IC900 IC903 IC908 IC910 IC950	ACU2500 ACP200	PR830 PR1225	JC8003 JC8015 JC5015 JC5118	PN15M PN215 PCA12M JP4115
P20			MP6120 VP15TF	GC1010 GC1030 GC1130 GC2030	KC522M KC525M KC527M KC610M KC620M KC635M KC715M KC720M KC730M KTPK20	F25M MP3000	IC250 IC300 IC328 IC330 IC350 IC808 IC810 IC830 IC900 IC908 IC910 IC928 IC950 IC1008	ACU2500 ACP200	AH3225 AH725 AH120 GH330 AH330 AH9130 AH6030	PR830 PR1225 PR1230 PR1525	JC5015 JC5040 JC6235 JC8015 JC5118 JC6235 JC7560P JC8118P	CY9020 JP4120 CY150

P

TECHNICAL DATA

Note 1) The tables above are based on published data and not authorized by each manufacturer.

GRADES COMPARISON TABLE

PVD COATED GRADE

Classification	ISO	Mitsubishi Materials	Sandvik	Kennametal	Seco Tools	Iscar	Sumitomo Electric	Tungaloy	Kyocera	Dijet	MOLDINO	
	Symbol											
P	P30	MP6120	GC1010	KC735M	F25M	IC250 IC300	ACU2500 ACP200 ACP300	AH725 AH120	PR1230 PR1525	JC6235 JC7560	JS4045	
		VP15TF	GC1030	KC725M	MP3000	IC328 IC330		AH130 AH140		JC8050 JC7560P	CY250	
	P40	VP30RT	MP6130	GC2030	KC530M	F30M	IC350 IC830	ACP300	AH3035	PR1525	JC5015 JC8118	CY250V
			VP30RT	GC1130	KC537M	MP2050	IC845 IC900		AH6030		JC5040 JC8118P	HC844
	M	M01					IC907					PN08M PN208
		M10		GC1025 GC1030 GC1010 GC1130	KC715M KC515M		IC903	ACU2500 ACM100		PR1225		PN15M PN215
		M20	VP15TF MP7130 MP7030 VP20RT	GC1025 GC1030 GC1040 GC2030 S30T	KC610M KC635M KC730M KC720M KC522M KC525M KCPM40 KTPK20	F25M MP3000	IC250 IC300 IC808 IC830 IC900 IC908 IC928 IC1008	ACU2500 ACP200	AH725 AH120 GH330 AH330 GH110 AH6030 AH9130	PR1025 PR1225	JC5015 JC5118 JC8015	JP4120
		M30	VP15TF MP7130 MP7030 VP20RT MP7140 VP30RT	S30T GC1040 GC2030	KC537M KC725M KC735M KCPM40 KC530M	F30M F40M MP3000 MP2050	IC250 IC300 IC328 IC330 IC380 IC830 IC882 IC928 IC1008	ACP200 ACP300 ACM300	AH120 AH725 AH130 AH140 GH130 AH730 GH340 AH9130 AH3135 AH4035	PR830 PR1225 PR1525 PR1535	JC5015 JC7560 JC8015 JC7560P JC8050 JC8118 JC5118 JC8118P	JS4045 CY250 HC844
		M40	MP7140 VP30RT			F40M MP2050	IC250 IC300 IC328 IC330 IC882 IC1008	ACP300 ACM300	AH140 AH3135 AH4035	PR1525 PR1535	JC5015 JC7560 JC5118 JC7560P JC8050 JC8118 JC8118P	PTH30E PTH40H JM4160
	K	K01	MP8010						AH110 GH110 AH330		JC8003	ATH80D ATH08M TH308
		K10	MP8010	GC1010	KC514M KC515M KC527M KC635M	MK2050	IC350 IC810 IC830 IC900 IC910 IC928 IC950 IC380 IC1008	ACU2500 ACK3000	AH110 GH110 AH725 AH120 GH130 AH330	PR1210 PR1510	JC8015	ATH10E TH315 CY100H
		K20	VP15TF VP20RT	GC1010 GC1020	KTPK20 KC514M KC610M KC520M KC620M KC524M	MK2000 MK2050	IC350 IC808 IC810 IC830 IC900 IC908 IC910 IC928 IC950 IC1008	ACU2500 ACK300 ACK3000	GH130 AH9130 AH9030	PR1210 PR1510	JC5015 JC8015 JC6235	CY150 JP4120 CY9020 PTH13S
K30		VP15TF VP20RT	GC1020	KC522M KC725M KC524M KC735M KC537M	MK2050	IC350 IC808 IC830 IC908 IC928 IC950 IC1008	ACK300 ACK3000			JC6235 JC5015 JC8015 JC8118 JC8118P	CY250 JS4045	
S	S01					IC907 IC908 IC808 IC903		AH110 AH710	PR1210	JC8003 JC8015 JC5118	PN08M PN208	
	S10	MP9120 VP15TF	GC1130 GC1010 GC1030 GC2030	KC510M	MS2050	IC903 IC907 IC908 IC840 IC910 IC808	EH520Z EH20Z ACM100	AH120 AH725	PR1210	JC8003 JC5015 JC8015 JC5118	JS1025 JP4120	
	S20	MP9120 VP15TF MP9130 MP9030	S30T GC2030 GC1030 GC1130	KC522M KC525M KCSM30 KCPM40	MS2050 MP2050	IC300 IC908 IC808 IC900 IC830 IC928 IC328 IC330 IC840 IC882 IC380	EH520Z EH20Z ACK300 ACP300	AH725 AH6030 AH130	PR1535	JC8015 JC5015 JC8050 JC5118	PTH30H	
	S30		GC2030 GC1040	KC725M KCPM40	MS2050 F40M KCSM40	IC830 IC882 IC928	ACP300 ACM300	AH3135	PR1535	JC8050 JC7560 JC5118	JM4160	
H	H01	MP8010 VP05HT				IC903				JC8003 DH103 JC8008 DH102		
	H10	VP15TF VP10H	GC1130 GC1010 GC1030	KC505M KC510M	MH1000 F15M	IC900 IC808 IC907 IC905				JC8003 JC8008 JC8015 JC5118 JC8118P	JP4105 TH303 TH308 PTH08M ATH08M ATH80D	
	H20	VP15TF	GC1030 GC1130			F15M	IC900 IC808 IC908 IC380 IC1008		AH3135	JC8015 JC5118 JC8118P	JP4115 TH315	
	H30					MP3000 F30M	IC380 IC900 IC1008		AH3135		JP4120	

TECHNICAL DATA

Note 1) The tables above are based on published data and not authorized by each manufacturer.

CBN

Classification	ISO		Mitsubishi Materials	Sandvik	Seco Tools	Sumitomo Electric	Tungaloy	Kyocera	Dijet
	Symbol								
Turning	H	H01	BC8105 BC8110 MB8110	CB7105	CBN060K	BNC100 BNX10 BN1000 BNC2010	BXM10 BX310	KBN05M KBN10M KBN510	
		H10	BC8110 MBC020 BC8120 BC8220 MB8025 MB8110 MB8120	CB7115 CB7015	CBN010	BNC160 BNX20 BN2000 BNC2020	BXM10 BX330 BX530	KBN05M KBN25M KBN525	JBN300
		H20	MBC020 BC8120 BC8220 MB8025 MB8120	CB7125 CB7025 CB20	CBN150 CBN160C	BNC200 BNX25 BN250 BNC2020	BXM20 BXA20 BX360	KBN525 KBN05M KBN25M	JBN245
		H30	BC8130 MB8130	CB7135 CB7525	CBN150 CBN160C	BNC300 BN350	BXC50 BX380	KBN35M	
	S	S01	MB730 MB8025		CBN170	BN700 BN7000	M714B		
		S10				BNS8125	BX470, BX480		
		S20							
		S30							
	K	K01	MB710 BC5110 MB5015			BN500 BNC500	BX870 BX930 BX910		
		K10	MB730 MB4020 MB4120	CB7525		BN700 BN7500 BN7000	BX470 BX480	KBN60M	JBN795
		K20	MB730 MB4020 MB4120		CBN200	BN700 BN7000	BX480	KBN60M	JBN500
		K30	BC5030	CB7925	CBN300 CBN400C CBN500	BNS800 BNC8115, BNC8125	BX90S BXC90	KBN900	
	Sintered Alloy		MB4020 MB4120		CBN200	BN7500 BN7000 BNC7115	BX470 BX480	KBN570 KBN70M	

P

TECHNICAL DATA

PCD

Classification	ISO		Mitsubishi Materials	Sandvik	Seco Tools	Sumitomo Electric	Tungaloy	Kyocera	Dijet
	Symbol								
Turning	N	N01	MD205	CD05	PCD05	DA90	DX180 DX160	KPD001	JDA30 JDA735
		N10	MD220	CD10	PCD10	DA150	DX140	KPD010	
		N20	MD220		PCD20	DA2200	DX120		JDA715
		N30	MD230 MD2030		PCD30 PCD30M	DA1000	DX110	KPD230	JDA10

Note 1) The tables above are based on published data and not authorized by each manufacturer.

Memo

A series of horizontal dashed lines for writing, spanning the width of the page.

INDEX

INDEX FOR TOOL NUMBER

A.....	2
B.....	2
C.....	2
D.....	2
E.....	2
F.....	2
G.....	3
H.....	3
J.....	3
K.....	3
L.....	3
M.....	3
N.....	4
O.....	4
P.....	4
Q.....	4
R.....	4
S.....	4
T.....	5
U.....	5
V.....	5
W.....	5
X.....	6
Z.....	6
NUMBER•OTHERS	6



INDEX FOR TOOL NUMBER

Order Number	PRODUCT NAME	Page	Order Number	PRODUCT NAME	Page
A			B		
AEMW○○○○○○ER.....	Insert (For BAE type end mill).....	L023	BCP○○○.....	Shim pin.....	N014
AHX440S-○○○○○○OR.....	AHX440S type face mill.....	K034	BOES101.....	Set bolt.....	N009
AHX475S-○○○○○○OR.....	AHX475S type face mill.....	K038	BPT322.....	Shim.....	N011
AHX640S-○○○○○○OR.....	AHX640S type face mill.....	K041	BRP○NR○○○○M○○.....	BRP type end mill.....	K190
AHX640W-○○○○○○R/L.....	AHX640W type face mill.....	K048	BRP6P/N-○○○○○○R.....	BRP type face mill.....	K190
AJS○○○○T○○.....	Clamp screw.....	N003	BRS○○○.....	Clamp screw.....	N003
AJX○○-○○○○○○OR.....	AJX type face mill.....	K180	C		
AJX○○R○○AM○○.....	AJX type end mill.....	K182	CA○○○.....	Clamp bridge.....	N015
AJX○○R○○SA○○S/L/ES/EL.....	AJX type end mill.....	K183, K184	CAS51T.....	Set screw.....	N003
AMS○.....	Clamp bridge.....	N015	CBS○.....	Breaker piece.....	N017
AOGT○○○○○○PEFR-GM.....	Insert (For APX3000 type cutter).....	K137, K149, L022	CBS○○.....	Breaker piece.....	N017
AOMT○○○○○○PEER-○.....	Insert (For APX3000•4000 type cutter).....	K137, K144, K149, K153, L022	CBT○.....	Breaker piece.....	N017
APGT○○○○PDFR-G2.....	Insert (For BAP300•400 type cutter).....	L023	CCK○○.....	Clamp bridge.....	N015
APMT○○○○PDER-H○.....	Insert (For BAP300•400/SRM2 type cutter).....	K233, 229, L023	CCMX○○○○○○EN-○.....	Insert (For DCCC type end mill).....	K201, L024
APMT○○○○PDER-M○.....	Insert (For BAP300•400/SRM2 type cutter).....	K233, K249, L023	CCP○○.....	Shim pin.....	N014
APX3K-○○○A○○A○○○RA.....	APX3000 type end mill.....	K148	CCTC1.....	Clamp bridge.....	N015
APX3KR○○○○S○○○○○○A.....	APX3000 type end mill.....	K147	CESPR○○○○S○○.....	CESP type end mill.....	K230
APX3000-○○○A○○RA.....	APX3000 type face mill.....	K135	CFSPR○○○○S○○.....	CFSP type end mill.....	K230
APX3000R○○○○M○○A/A○○.....	APX3000 type end mill.....	K136	CGSPR○○○○S○○.....	CGSP type end mill.....	K230
APX3000R○○○○SA○○SA/LA/ELA.....	APX3000 type end mill.....	K134	CK○○○.....	Clamp bridge.....	N015
APX3000R○○○○WA○○○A.....	APX3000 type end mill.....	K133	CKW6.....	Clamp bridge.....	N016
APX4K-○○○A○○A○○○RA.....	APX4000 type end mill.....	K152	CPMT○○○○ZPEN-M○.....	Insert (For PMR type end mill).....	K237, L024
APX4KR○○○○WA○○○○○○A.....	APX4000 type end mill.....	K151	CS○○.....	Shim.....	N011
APX4000-○○○A○○RA.....	APX4000 type face mill.....	K142	CSF401260T.....	Clamp screw.....	N003
APX4000R○○○○M○○A○○.....	APX4000 type end mill.....	K143	CS○○○T.....	Clamp screw.....	N003
APX4000R○○○○SA○○SA/LA/ELA.....	APX4000 type end mill.....	J089	CS○○○○○○T.....	Clamp screw.....	N003
APX4000R○○○○WA○○SA/LA/ELA.....	APX4000 type end mill.....	K140	CT○○.....	Shim.....	N011
AQXR○○○○A/N○○S/L.....	AQX type end mill.....	K172, K173	CT32T1.....	Shim.....	N012
AQXR○○○○M○○A○○.....	AQX type end mill.....	K174	D		
ARP○P-○○○○○○AR.....	ARP type face mill.....	K238	DCCCR○○○○S○○.....	DCCC type end mill.....	K200
ARP○PR○○○○AM○○○○.....	ARP type end mill.....	K240	DCK○○○○.....	Clamp bridge.....	N016
ARP○PR○○○○SA○○L/M.....	ARP type end mill.....	K239	DCSVN32.....	Shim.....	N011
ASPX4-○○○A○○A○○○RA○○.....	ASPX type end mill.....	K208	DC○○○○T.....	Clamp screw.....	N003
ASPX4R0805H○○○○A127SA.....	ASPX type end mill.....	K209	DKS○.....	Clamp screw.....	N003
ASX400-○○○○○○OR.....	ASX400 type face mill.....	K068	E		
ASX400R○○○○M16.....	ASX400 type end mill.....	K069	EGS○○○○○.....	Clamp screw.....	N004
ASX400R○○○○S32.....	ASX400 type end mill.....	K069	ESS42.....	Shim.....	N011
ASX445-○○○○○○R/L.....	ASX445 type face mill.....	K026	EST○○.....	Shim.....	N011
ASX445R○○○○S32.....	ASX445 type face mill.....	K027	F		
AXD4000A-050A04RD/E.....	AXD4000A type face mill.....	K162	FC400890T.....	Clamp screw.....	N004
AXD4000-○○○○○○RA/B.....	AXD4000 type face mill.....	K155	FMAX-○○○A○○R.....	FMAX type face mill.....	K052
AXD4000R○○○○SA○○○A/B.....	AXD4000 type end mill.....	K156	FMAX-○○○B○○R.....	FMAX type face mill.....	K053
AXD7000-○○○○○○RA/B.....	AXD7000 type face mill.....	K166	FMAXR1○○○○CLW.....	FMAX type face mill.....	K051
AXD7000R○○○○○A-H63A.....	AXD7000 type end mill.....	K167			
AXD7000R○○○○SA○○SA/B.....	AXD7000 type end mill.....	K166			

Order Number	PRODUCT NAME	Page	Order Number	PRODUCT NAME	Page
G			LLCL000	Clamp lever	N014
GOER1400XFR2	Insert (For FMAX type cutter)	K054, L051	LLCL00S	Clamp lever	N014
GOER14008PXFR2-8	Insert (For FMAX type cutter)	K054, L051	LLCS000	Clamp screw	N005
H			LLCS000S	Clamp screw	N005
HBH00000	Clamp screw	N002	LLP00	Shim pin	N014
HBHA00000	Clamp screw	N002	LLR0	Radial screw	N004
HDS00000	Set bolt	N009	LLSCN00	Shim	N011
HFF06015	Clamp screw	N004	LLSCN0TO	Shim	N011
HFF08000H	Set bolt	N009	LLSCP00	Shim	N011
HKY00D	Driver	N002	LLSDN00	Shim	N011
HKY00F	Flag wrench	N002	LLSDP42	Shim	N011
HKY00L	L-wrench	N002	LLSRN000	Shim	N011
HKY00R	L-wrench	N002	LLSSN00	Shim	N011
HKY00T	T-wrench	N002	LLSSP42	Shim	N011
HKY00W	Flag wrench	N002	LLSTE32	Shim	N012
HS00	Clamp screw	N004	LLSTN00	Shim	N012
HSC00000	Clamp screw	N002, N009	LLSTP00	Shim	N012
HSC00000H	Set bolt	N009	LLSWN000	Shim	N012
HSCX00000H	Set bolt	N009	LLSWN0TO	Shim	N012
HSP05008C	Lock screw	N004	LLSWP00	Shim	N012
HSS00000	Clamp screw	N002	LNGU0000000PNE00	Insert (Side cutter)	L027
HY0	Bush screw	N004	LOGU00000000PNOR00	Insert (For VPX200/VPX300 type cutter)	K090, K104, K117, K126, L026, L027
HY-A1	Bush screw	N004	LS0	Clamp screw	N005
HY-V1	Bush screw	N004	LS00	Clamp screw	N005
J			LS00T	Clamp screw	N005
JDMT00000000ZDOR00	Insert (For AJX/PMC type cutter)	K185, L024	LS0000T	Clamp screw	N005
JDMW00000000ZDSR-FT	Insert (For AJX type cutter)	K185, L024	LS10TS	Clamp screw	N005
JOMT00000000ZZOR00	Insert (For AJX/PMC type cutter)	K185, L024	LS24H	Clamp screw	N005
JOMU00000000ZZER00	Insert (For WJX type cutter)	K074, K081, L025	M		
JOMW00000000ZZSR-FT	Insert (For AJX/PMC type cutter)	K185, L024	MBA000000H	Clamp screw	N009
JPGX00000000PPER-JM	Insert (For ASPX type cutter)	K210, L025	MGS6	Clamp screw	N005
JPMT060204-E	Insert (For TAB/CBJP type end mill)	L025	MHK5NR/L	Clamp bridge	N016
JPMX0000000000	Insert (For SPX type cutter)	K205, L025	MHS000R/L	Shim	N012
JSS0	Clamp screw	N004	MHT1	Clamp screw	N005
K			MK1K	Anti seize lubricant	N018
KGC1	Clamp bridge	N016	MK1KS	Anti seize lubricant	N018
KS0	Axial screw	N004	MLCP42	Shim	N012
KS00	Set bolt	N004	MLDP42	Shim	N012
KSN0	Clamp screw	N010	MLSP42	Shim	N012
KSN3	Micro Adjustment Nut	N010	MLTP32	Shim	N012
KS0S	Pre-set screw	N004	MPMT00000000	Insert (For CBMP/ECMP/TAB type end mill)	L030
KSS0	Clamp screw	N010	MPMW00000000	Insert (For TSMP type end mill)	K233, L030
KSS2	Large Adjustment Screw	N010	MPMX120412000	Insert (For SPX type end mill)	K205, L030
L			MP6	Shim pin	N014
LK1	Clamp bridge	N016	MSCN63	Shim	N012
			MSSN63	Shim	N012
			MTK0R/L	Clamp bridge	N016

INDEX FOR TOOL NUMBER

Order Number	PRODUCT NAME	Page	Order Number	PRODUCT NAME	Page
N			S		
NNMU130500ZEN-0Insert (For AHX440S type cutter)	K035, K039, L030	RS0000TClamp screw.....	N006
NNMU130508ZER-LInsert (For AHX440S type cutter)	K035, L030	S0Clamp screw.....	N006
NNMU200000ZEN-0Insert (For AHX440S type cutter)	K042, L031	SC00M00S00-HSK63AHSK63 arbor.....	K244
NNMU200000ZEN-00Insert (For AHX type cutter).....	K042, K049, L031	SC00M00S00S/LStraight arbor.....	K244
NNMU200608ZEN-0KInsert (For AHX640W*640S type cutter)	K042, K049, L031	SC00M00S00S/LWStraight arbor (Carbide shank)	K244
NNMU200712ZER-LInsert (For AHX640S type cutter)	K042, L031	SD00Set bolt	N006
NNMU200712ZER-MMInsert (For AHX640S type cutter)	K042, L031	SDEN1203AENInsert (For 45° corner angle type cutter)	L035
NP-GOER14000PXSRO5Insert (For FMAX type cutter).....	K054, L051	SECN0000EFOR1Insert (For SE415*515/QSE415 type cutter)	L051
NS000Clamp screw.....	N006	SEEN0000AFON0Insert (For SE445*545 type cutter).....	L035
NS000WClamp screw.....	N006	SEEN0000EFOR0Insert (For SE415*515/QSE415 type cutter)	L035, L036
O			S		
OEMX0000EOR1Insert (For OCTACUT type cutter).....	L031	SEER0000AFEN-JSInsert (For SE445*545/LSE445 type cutter).....	L035
OEMX0000EOR1-JSInsert (For OCTACUT type cutter).....	L031	SEER1203EFER-JSInsert (For SE*QSE415 type cutter)	L036
P			S		
PMF00000A00RPMF type end mill.....	K234	SEET13T3AGEN-JLInsert (For ASX445 type cutter).....	K028, L036
PMR000000A20RPMR type end mill	K236	SEEW1204AFTNInsert (For corner angle 45° type cutter)	L036
PMR000000BRPMR type end mill	K236	SEGT13T3AGFN-JPInsert (For ASX445 type cutter).....	K028, L036
P00SLock pin	N015	SEMNI204AZTNInsert (For 45° corner angle type cutter)	L036
PS00Shim	N011	SEMT13T3AGSN-FTInsert (For ASX445 type cutter).....	K028, L036
PT00Shim	N011	SEMT13T3AGSN-JHInsert (For ASX445 type cutter).....	K028, L037
PT00TORShim	N012	SEMT13T3AGSN-JMInsert (For ASX445 type cutter).....	K028, L037
P000USLock pin	N015	SETK00Clamp bridge	N016
PV000Shim	N013	SETS00Clamp screw.....	N006
P000WLock pin	N015	SFAN0000ZFF02Insert (For BF407 type cutter)	L037
P000WSLock pin	N015	SFCN0000ZFFR2Insert (For BF*QBF407 type cutter).....	L037
Q			S		
QOGT0000R-G1Insert (For AQX type cutter)	K175, L032	SLCS000Clamp screw.....	N006
QOMT0000R-M2Insert (For AQX type cutter)	K175, L032	SNC43B2SInsert (For BN425DN type cutter).....	L037
R			S		
RDHX0000M00Insert (Class H tolerance).....	L032	SNEN0000ENInsert (Class E tolerance).....	L037
RDMX0000M00Insert (Class M tolerance)	L033	SNGU000000ANE0-0Insert (For WSX445 type cutter).....	K019, L037
RDZX0000M00Insert (Class M tolerance)	J139, L033	SNMF43B2GInsert (For BN425/DN type cutter).....	L037
REMXX0000EN-JSInsert (For OCTACUT type cutter).....	L033	SOET12T308PEER-JLInsert (For ASX400 type cutter).....	K070, L038
REMXX0000SNInsert (For OCTACUT type cutter).....	L033	SOGT12T308PEFR-JPInsert (For ASX400 type cutter).....	K070, L038
RGEN2004M00NInsert (For SG20 type cutter).....	L033	SOMT12T300PEE0-00Insert (For ASX400 type cutter).....	K070, L038
RKY00SWrench	N002	SONX1206PE0Insert (For VOX400 type cutter)	K066, L038
RN-S0Clamp screw.....	N006	SPEN1203EETR1Insert (For FBP415 type cutter)	L051
RPHT0000M0E4-0Insert (For ARP type cutter).....	K241, L034	SPEN424AInsert (For FP490*590*690 type cutter).....	L039
RPMT0000M0E0-00Insert (For ARP5/6 type cutter).....	K241, L034	SPEN0000ED0Insert (For 15° corner angle type cutter)	L039
RPMT0000M0E-JSInsert (For BRP type cutter).....	K191, L034	SPEN0000EEE01Insert (For FBP415/QBP415 type cutter)	L039
RPMT0000M0E4-0Insert (For ARP type cutter).....	K241, L034	SPER1203EEER-JSInsert (For FBP415/QBP415 type cutter)	L039
RPMW0000M00Insert (For BRP type cutter).....	K191, L034	SPGN0000000Insert (For 11° Positive type cutter).....	L040
			SPGX1204100PPER-JMInsert (For ASPX type cutter)	K210, L040
			SPMB1204APTInsert (For BSP type end mill)	L040
			SPMN0000000Insert (For 11° Positive type cutter)	L040
			SPMN0000000TInsert (For 11° Positive type cutter).....	L040
			SPMT120408-AInsert (For TBE1 type end mill).....	L040
			SPMW0000000Insert (For CESP/CFSP/CGSP type cutter)	L040, K230
			SPMX120408-00Insert (For SPX type end mill)	K205, L041

Order Number	PRODUCT NAME	Page	Order Number	PRODUCT NAME	Page
SPNN1203EDR	Insert (For corner angle 15° type cutter)	L041	U		
SPSVN32	Shim	N013	UCR	Clamp bridge	N016
SPS1	Locator screw	N006	V		
SPX4-0000A24A058RA	SPX type end mill	K204	VFX5-000000A000R	VFX5 type end mill	K192
SPX4R00000SK50N0	SPX type end mill	K203	VFX6-0000A00A000R	VFX6 type end mill	K196
SRBT00	Insert (For SRB type)	K214, L042	VOX400-000000R	VOX400 type face mill	K065
SRFH00AM0000	SRF type end mill	K213, K217	VPX200-000A00A000R00	VPX200 type end mill	K116
SRFH00S00000	SRF type end mill	K213, K214, K216, K217	VPX200-000A00AR	VPX200 type face mill	K089
SRFT00	Insert (For SRF type end mill)	K214, L042	VPX200R00000AM00000	VPX200 type end mill	K088
SRG00C	Insert (For SRM2 type end mill)	K223, K229, L042	VPX200R000SA00S00000	VPX200 type end mill	K114
SRG00E	Insert (For SRM2 type end mill)	K223, K229, L042	VPX200R00000SA00S/L	VPX200 type end mill	K086
SRK1R	Clamp bridge	N016	VPX200R00000WA00S00000	VPX200 type end mill	K115
SRM00C-M	Insert (For SRM2 type end mill)	K223, L043	VPX200R00000WA00S/M	VPX200 type end mill	K087
SRM00E-M	Insert (For SRM2 type end mill)	K223, L043	VPX300-000A00AR	VPX300 type face mill	K103
SRM2000AM/M00S/L00/L	SRM2 type end mill	K222	VPX300-000A00A000R00	VPX300 type end mill	K125
SRM2000I00NLM/S	SRM2 type end mill	K228	VPX300R00000AM00000	VPX300 type end mill	K102
SRM20000NL0	SRM2 type end mill	K228	VPX300R00000SA00S/L	VPX300 type end mill	K100
SRM2000S00	SRM2 type end mill	K220, K221	VPX300R00000WA00S	VPX300 type end mill	K101
SRS5	Clamp screw	N006	VPX300R402SA32S00000	VPX300 type end mill	K124
STASX000N	Shim	N013	W		
STBS500N	Shim	N013	WCS000000H	Shim screw	N008
STS1	Shim screw	N006	WEC42EFTR5C	Wiper insert (For SE415•515 type cutter)	L049
SUFT00R00	Insert (For SUF type end mill)	K218, L043	WEC53AFTR5C	Wiper insert (For SE445•545/LSE445 type cutter)	L049
T			WEC53EFTR5C	Insert (For SE515 type cutter)	L049
TECN0000PE0R1	Insert (For NSE300•400/SE300•400 type cutter)	L044, L051	WEEW13T3AG0R3C	Wiper insert (For ASX445 type cutter)	K029, L052
TECN1603PE0R1W	Insert (For NSE300/SE300 type cutter)	L044	WEEW13T3AG0R8C	Wiper insert (For ASX445 type cutter)	K029, L049
TEEN0000PE0R/L0	Insert (For NSE300•400/SE300•400 type cutter)	L044	WJX09-000000AR	WJX09 type face mill	K072
TEER0000PEER-JS	Insert (For NSE300•400 type cutter)	L044	WJX09R00000SA000	WJX09 type end mill	K073
TIP000	Wrench	N002	WJX14-000000AR	WJX14 type face mill	K079
TKY00D	Driver	N002	WJX14R5003SA420	WJX14 type end mill	K080
TKY00F	Flag wrench	N002	WNEU1305ZEN4C-M	Wiper insert (For AHX type cutter)	K029, L049
TKY00L	Long wrench	N002	WNEU2000ZEN7C-0/00	Wiper insert (For AHX type cutter)	K042, K049, L049, L050
TKY00R	L-wrench	N002	WNGU1406ANEN8C-M	Wiper Insert (For WSX445 type cutter)	K019, L050
TKY00T	T-wrench	N002	WOWE12T308PE0R8C	Wiper insert (For ASX400 type cutter)	K050, L050
TKY00W	Flag wrench	N002	WOEX1206PER5C	Insert (For VOX400 type cutter)	L050
TPEN0000P00	Insert (For corner angle 0° type cutter)	L045	WPC42EE0R10C	Wiper insert (For FBP415/QBP415 type cutter)	L050
TPEW1303ZP0R2	Insert (For PMF type end mill)	K234, L045, L052	WPSTN00	Shim	N013
TPMN0000000	Insert (For 11° Positive type cutter)	L045	WPSWC43	Shim	N013
TPMN0000000T	Insert (For 11° Positive type cutter)	L045	WPSWN43	Shim	N013
TPNN2204PDR	Insert (For corner angle 0° type cutter)	L045			
TPS0	Clamp screw	N008			
TSMPR0000S00	TSMP type end mill	K232			
TS0	Clamp screw	N007			
TSR000000S	Clamp screw	N008			
TSS000000	Radial screw	N008			

INDEX FOR TOOL NUMBER

Order Number	PRODUCT NAME	Page	Order Number	PRODUCT NAME	Page
WS○○○○○○○T	Clamp screw	N008			
WS○○○○○○○TPS	Clamp screw	N008			
WSX445-○○○○○○○L	WSX445 type face mill	K017			
WSX445-○○○○○○○R	WSX445 type face mill	K016			
WSX445R○○○○○SA32M	WSX445 type face mill	K018			
WWX400-○○○○○○○R	WWX400 type face mill	K056			
WWX400R○○○○○SA32M	WWX400 type end mill	K058			
X					
XDGX○○○○○○○PDER-GM	...Insert (For AXD4000 type cutter)	K157, K163, L046			
XDGX○○○○○○○PDFR-GL	...Insert (For AXD4000•7000 type cutter)	K157, K163, K167, L046			
XDGX○○○○○○○PDFR-GM	...Insert (For AXD4000 type cutter)	K157, K163, L046			
XNMU○○○○○○○R-OS	...Insert (For VFX5•VFX6 type cutter)	K194, K198, L047			
Z					
ZCMX○○○○○○○ER-○	...Insert (For DCCC type end mill)	K201, L048			
NUMBER•OTHERS					
6NGU○○○○○○○PNFR-L	...Insert (For WWX400 type cutter)	K059, L022			
6NMU○○○○○○○PNER-○	...Insert (For WWX400 type cutter)	K059, L022			

1

INDEX

MITSUBISHI MATERIALS CORPORATION

GERMANY

MMC HARTMETALL GMBH
Comeniusstr. 2 . 40670 Meerbusch
Phone +49 2159 91890 . Fax +49 2159 918966
Email admin@mmchg.de

U.K.

MMC HARDMETAL U.K. LTD.
Mitsubishi House . Galena Close . Tamworth . Staffs. B77 4AS
Phone +44 1827 312312 . Fax +44 1827 312314
Email sales@mitsubishicarbide.co.uk

SPAIN

MITSUBISHI MATERIALS ESPAÑA, S.A.
Calle Emperador 2 . 46136 Museros/Valencia
Phone +34 96 1441711 . Fax +34 96 1443786
Email comercial@mmevalencia.es

FRANCE

MMC METAL FRANCE S.A.R.L.
6, Rue Jacques Monod . 91400 Orsay
Phone +33 1 69 35 53 53 . Fax +33 1 69 35 53 50
Email mmfsales@mmc-metal-france.fr

POLAND

MMC HARDMETAL POLAND SP. Z O.O
Al. Armii Krajowej 61 . 50 - 541 Wrocław
Phone +48 71335 1620 . Fax +48 71335 1621
Email sales@mitsubishicarbide.com.pl

RUSSIA

MMC HARDMETAL OOO LTD.
Electrozavodskaya St. 24 . build. 3 . Moscow . 107023
Phone +7 495 725 58 85 . Fax +7 495 981 39 79
Email info@mmc-carbide.ru

ITALY

MMC ITALIA S.R.L.
Viale Certosa 144 . 20156 Milano
Phone +39 0293 77031 . Fax +39 0293 589093
Email info@mmc-italia.it

TURKEY

MMC HARTMETALL GMBH ALMANYA - İZMİR MERKEZ ŞUBESİ
Adalet Mahallesi Anadolu Caddesi No: 41-1 . 15001 35530 Bayraklı/İzmir
Phone +90 232 5015000 . Fax +90 232 5015007
Email info@mmchg.com.tr

www.mitsubishicarbide.com | www.mmc-hardmetal.com