

 MITSUBISHI MATERIALS

TURNING TOOLS



DIA  **EDGE**

NEW

MITSUBISHI MATERIALS

INTRODUCING THE NEW GENERAL CATALOGUE C009 – 2022/2023

TARGETED, COMPACT, HANDY.

Mitsubishi Materials' wide product portfolio is now shown in catalogues that represent individual application areas, offering users fast and easy access to targeted product information.

There is now a set of catalogues in small, practical sizes that comprise the following five volumes:

- **TURNING TOOLS**
- **DRILLING TOOLS**
- **SOLID MILLING TOOLS**
- **INDEXABLE MILLING TOOLS**
- **MPLUS**

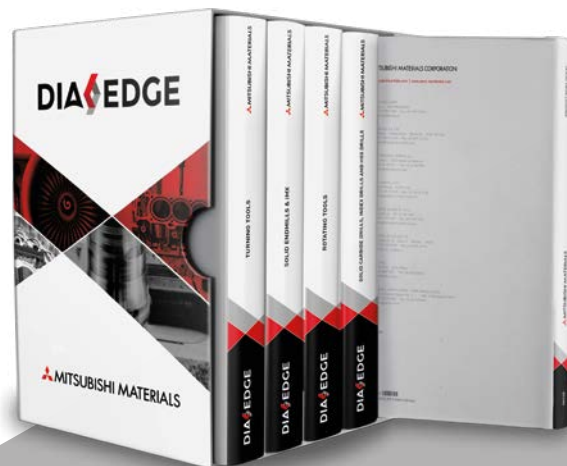

NEW DESIGN

EASY HANDLING

HIGHER FLEXIBILITY

INDIVIDUAL APPLICATION AREAS

The slipcase provided enables easy storage and offers the required space for all future catalogues, including the product news brochures that will be published within the 2-year life cycle of the catalogue. Each new product news brochure published within the 2-year cycle will completely replace the previous version, therefore, please dispose of old versions.

NOTES:

- With this publication, all previous general catalogues and product news brochures lose their validity.
- The product news catalogues are released twice a year, in April and October.
- The new general catalogue can be ordered only as a set of five. **Order number: C009E**



DIGITAL VERSION

For the digital version of the catalogue, please scan the QR code or visit us at www.mhg-mediastore.net

TURNING TOOLS



QUALITY - HIGHEST STANDARDS ACROSS PRODUCTS AND SERVICES

Turning tools from Mitsubishi embody this philosophy and have been convincing the global market for more than 30 years!

Mitsubishi's precision tools enrich the metalworking industry with durability, speed and accuracy.

Whether it is a grooving tool, an ISO insert or vibration-damping boring bar, the extensive range of turning tools has performance in mind.

DIA EDGE

CREATE A BETTER FUTURE TOGETHER WITH OUR CUSTOMERS

Announcing DIAEDGE, our new brand of tools that brings together cutting-edge technologies, exciting all who use them.

The aim is not only to offer value with our tools, but to think together with customers, share inspiration and continue to take on new challenges.



 **MITSUBISHI MATERIALS**

INDEX

TURNING TOOLS



TURNING INSERTS	A001
PCBN & PCD TURNING INSERTS	B001
EXTERNAL TURNING TOOLS	C001
SMALL TOOLS	D001
BORING BARS	E001
GROOVING AND CUTTING OFF	F001
THREADING	G001
HSK-T TOOLS	H001
SPARE PARTS	N001
TECHNICAL DATA	P001
INDEX	1
GENERAL INFORMATION	

HOW TO READ THE STANDARD OF TURNING INSERTS

● How this section page is organised

- Organised according to the insert shape. (Refer to the index on the next page.)
- Inserts are arranged in order of :
 - Negative inserts (with hole→without hole)
 - Positive inserts (with hole→without hole)
- Breakers are arranged in order of :
 - Finish Cutting→Light Cutting→Medium Cutting→Rough Cutting→Heavy Cutting

GRADE APPLICATION RECOMMENDED FOR EACH WORK MATERIAL

Cutting conditions suitable for each type of work material is shown as a general guide to select the grade.

● : Stable Cutting ● : General Cutting ✦ : Unstable Cutting

SHAPE & ANGLE MARK

INDICATION OF NEGATIVE/ POSITIVE TYPE

PRODUCT SECTION

TITLE OF PRODUCT ACCORDING TO THE INSERT TYPE

TURNING INSERTS [NEGATIVE]

80° CN TYPE INSERTS WITH HOLE

CHIP CONTROL RANGE FOR WORK MATERIALS

Work Material: P Steel, M Stainless Steel, K Cast Iron, N Non-ferrous Metal, S Heat-resistant Alloy, Titanium Alloy

Shape	Order Number	RE (mm)	Coated	Stable Cutting	General Cutting	Unstable Cutting
FP	CNMG120402-FP	0.2	●●●●●●	●●●●●●	●●●●●●	●●●●●●
	CNMG120408-FP	0.8	●●●●●●	●●●●●●	●●●●●●	●●●●●●
	CNMG120412-FP	1.2	●●●●●●	●●●●●●	●●●●●●	●●●●●●
FH	CNMG120402-FH	0.2	●●●●●●	●●●●●●	●●●●●●	●●●●●●
	CNMG120404-FH	0.4	●●●●●●	●●●●●●	●●●●●●	●●●●●●
	CNMG120408-FH	0.8	●●●●●●	●●●●●●	●●●●●●	●●●●●●
FS	CNMG120404-FS	0.4	●●●●●●	●●●●●●	●●●●●●	●●●●●●
	CNMG120408-FS	0.8	●●●●●●	●●●●●●	●●●●●●	●●●●●●
	CNMG120412-FS	1.2	●●●●●●	●●●●●●	●●●●●●	●●●●●●
FY	CNMG120404-FY	0.4	●●●●●●	●●●●●●	●●●●●●	●●●●●●
	CNMG120408-FY	0.8	●●●●●●	●●●●●●	●●●●●●	●●●●●●
	CNMG120412-FY	1.2	●●●●●●	●●●●●●	●●●●●●	●●●●●●
FJ	CNMG120404-FJ	0.4	●●●●●●	●●●●●●	●●●●●●	●●●●●●
	CNMG120408-FJ	0.8	●●●●●●	●●●●●●	●●●●●●	●●●●●●
	CNMG120412-FJ	1.2	●●●●●●	●●●●●●	●●●●●●	●●●●●●
LP	CNMG120404-LP	0.4	●●●●●●	●●●●●●	●●●●●●	●●●●●●
	CNMG120408-LP	0.8	●●●●●●	●●●●●●	●●●●●●	●●●●●●
	CNMG120412-LP	1.2	●●●●●●	●●●●●●	●●●●●●	●●●●●●
LM	CNMG120404-LM	0.4	●●●●●●	●●●●●●	●●●●●●	●●●●●●
	CNMG120408-LM	0.8	●●●●●●	●●●●●●	●●●●●●	●●●●●●
	CNMG120412-LM	1.2	●●●●●●	●●●●●●	●●●●●●	●●●●●●

● : Inventory maintained. * : Inventory maintained in Japan. ○ : Non stock, produced to order only.

LEGEND FOR STOCK STATUS MARK
Is shown on the left hand page of each double-page spread.

CUTTING APPLICATION
Is shown in order of: Finish→Light→Medium→Rough→Heavy.

PHOTO OF INSERT

INDICATION OF CHIPBREAKER
Indicates the designation for a chipbreaker.

● Graph of chip control by work material

Shows recommended chipbreakers and chip control range according to the work material and cutting application.

Graphs are coloured according to the applications (Finish→Light→Medium→Rough→Heavy)

and contain recommended breakers for each application.

Finish Cutting : — Light Cutting : — Medium Cutting : —
Rough Cutting : — Heavy Cutting : —

INSERT NUMBER

STOCK STATUS

INSERT GRADES

CHIP CONTROL RANGE FOR WORK MATERIALS

Work Material: P Steel, M Stainless Steel, K Cast Iron, N Non-ferrous Metal, S Heat-resistant Alloy, Titanium Alloy

Shape	Order Number	RE (mm)	Coated	Stable Cutting	General Cutting	Unstable Cutting
LK	CNMG120404-LK	0.4	●●●●●●	●●●●●●	●●●●●●	●●●●●●
	CNMG120408-LK	0.8	●●●●●●	●●●●●●	●●●●●●	●●●●●●
	CNMG120412-LK	1.2	●●●●●●	●●●●●●	●●●●●●	●●●●●●
LS	CNMG090304-LS	0.4	●●●●●●	●●●●●●	●●●●●●	●●●●●●
	CNMG090308-LS	0.8	●●●●●●	●●●●●●	●●●●●●	●●●●●●
	CNMG120402-LS	0.2	●●●●●●	●●●●●●	●●●●●●	●●●●●●
SH	CNMG120408-SH	0.8	●●●●●●	●●●●●●	●●●●●●	●●●●●●
	CNMG09T304-SH	0.4	●●●●●●	●●●●●●	●●●●●●	●●●●●●
	CNMG09T308-SH	0.8	●●●●●●	●●●●●●	●●●●●●	●●●●●●
SA	CNMG120404-SA	0.4	●●●●●●	●●●●●●	●●●●●●	●●●●●●
	CNMG120408-SA	0.8	●●●●●●	●●●●●●	●●●●●●	●●●●●●
	CNMG120412-SA	1.2	●●●●●●	●●●●●●	●●●●●●	●●●●●●
SW	CNMG120404-SW	0.4	●●●●●●	●●●●●●	●●●●●●	●●●●●●
	CNMG120408-SW	0.8	●●●●●●	●●●●●●	●●●●●●	●●●●●●
	CNMG120412-SW	1.2	●●●●●●	●●●●●●	●●●●●●	●●●●●●
SY	CNMG120404-SY	0.4	●●●●●●	●●●●●●	●●●●●●	●●●●●●
	CNMG120408-SY	0.8	●●●●●●	●●●●●●	●●●●●●	●●●●●●
	CNMG120412-SY	1.2	●●●●●●	●●●●●●	●●●●●●	●●●●●●
MJ	CNMG120404-MJ	0.4	●●●●●●	●●●●●●	●●●●●●	●●●●●●
	CNMG120408-MJ	0.8	●●●●●●	●●●●●●	●●●●●●	●●●●●●
	CNMG120412-MJ	1.2	●●●●●●	●●●●●●	●●●●●●	●●●●●●

* Please refer to page A028 before using the SW breaker (wiper insert).

CHIP BREAKERS → A040
GRADES → A030
IDENTIFICATION → A027

PAGE REFERENCE

- CHIPBREAKERS
- GRADES
- TECHNICAL DATA

Indicates reference pages, on the right hand page of each double-page spread.

APPLICABLE HOLDER PAGE

Indicates reference pages for details of applicable holders.

CORNER RADIUS (RE)

● To Order : Please specify

① insert number and ② grade.

TURNING

INSERT GRADES INSERT STANDARDS

IDENTIFICATION	A002
HOLE GEOMETRY	A004
PRECISION BREAKER SYSTEM	A006
OUTLINE OF TOOL NAVI.....	A009
OPTIMUM GRADES AND CHIPBREAKERS FOR EXTERNAL TURNING...	A010
PRECISION BREAKER SYSTEM	A026
WIPER INSERT.....	A028
GRADES FOR TURNING	A030
TURNING APPLICATION RANGE	A031
COATED CARBIDE (CVD)	A034
COATED CARBIDE (PVD)	A036
CERMET	A038
COATED CERMET	A039
CEMENTED CARBIDE	A040
CLASSIFICATION OF INSERTS	A042
RECOMMENDED CUTTING CONDITIONS	A074

STANDARD OF INSERTS

NEGATIVE INSERTS WITH HOLE

CN ⁰⁰ TYPE...RHOMBIC 80°	A098
DN ⁰⁰ TYPE...RHOMBIC 55°	A105
RN ⁰⁰ TYPE...ROUND	A112
SN ⁰⁰ TYPE...SQUARE 90°	A113
TN ⁰⁰ TYPE...TRIANGULAR 60°	A119
VN ⁰⁰ TYPE...RHOMBIC 35°.....	A126
WN ⁰⁰ TYPE...TRIGON 80°	A130

NEGATIVE INSERTS WITHOUT HOLE

KN ⁰⁰ TYPE...PARALLELOGRAM 55° ...	A135
CN ⁰⁰ TYPE...RHOMBIC 80°	A136
SN ⁰⁰ TYPE...SQUARE 90°	A137
TN ⁰⁰ TYPE...TRIANGULAR 60°	A138

POSITIVE INSERTS WITH HOLE

CC ⁰⁰ TYPE...RHOMBIC 80°	A139
CP ⁰⁰ TYPE...RHOMBIC 80°	A146
DC ⁰⁰ TYPE...RHOMBIC 55°	A147
DE ⁰⁰ TYPE...RHOMBIC 55°	A153
RC ⁰⁰ TYPE...ROUND	A154

SC ⁰⁰ TYPE...SQUARE 90°	A155
SP ⁰⁰ TYPE...SQUARE 90°.....	A157
TC ⁰⁰ TYPE...TRIANGULAR 60°	A158
TE ⁰⁰ TYPE...TRIANGULAR 60°	A161
TP ⁰⁰ TYPE...TRIANGULAR 60°	A162
VB ⁰⁰ TYPE...RHOMBIC 35°	A164
VC ⁰⁰ TYPE...RHOMBIC 35°.....	A167
VD ⁰⁰ TYPE...RHOMBIC 35°.....	A170
VP ⁰⁰ TYPE...RHOMBIC 35°.....	A171
WB ⁰⁰ TYPE...TRIGON 80°	A172
WC ⁰⁰ TYPE...TRIGON 80°.....	A173
WP ⁰⁰ TYPE...TRIGON 80°.....	A174
XC ⁰⁰ TYPE...RHOMBIC 25°	A175

POSITIVE INSERTS WITHOUT HOLE

RTG TYPE.....	A176
SP ⁰⁰ TYPE...SQUARE 90°.....	A177
TC ⁰⁰ TYPE...TRIANGULAR 60°	A179
TP ⁰⁰ TYPE...TRIANGULAR 60°	A180

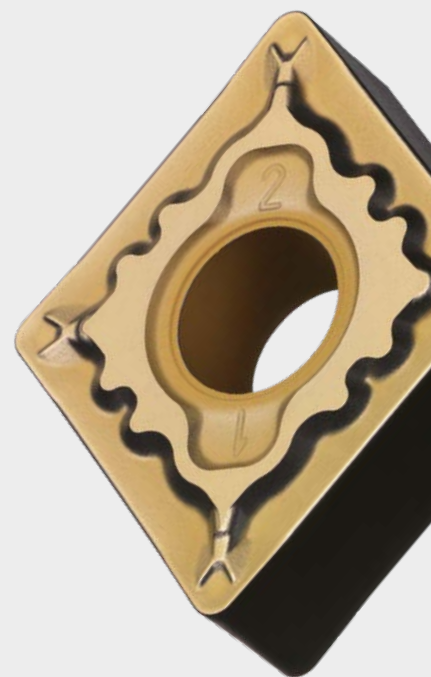

IDENTIFICATION

TURNING INSERTS

A

Symbol	Insert Shape	
H	Hexagonal	
O	Octagonal	
P	Pentagonal	
S	Square	
T	Triangular	
C	Rhombic 80°	
D	Rhombic 55°	
E	Rhombic 75°	
F	Rhombic 50°	
M	Rhombic 86°	
V	Rhombic 35°	
W	Trigon	
L	Rectangular	
A	Parallelogram 85°	
B	Parallelogram 82°	
K	Parallelogram 55°	
R	Round	
X	Special Design	

① Symbol for Insert Shape

Triangular insert with a facet (Secondary Cutting Edge)

③ Symbol for Tolerance Class				Detail of M Class Insert Tolerance						
Symbol	Tolerance of Nose Height M (mm)	Tolerance of Inscribed Circle IC (mm)	Tolerance of Thickness S (mm)	● Tolerance of Nose Height M (mm)						
				D.I.C.	Triangular	Square	Rhombic 80°	Rhombic 55°	Rhombic 35°	Round
A	±0.005	±0.025	±0.025	6.35	±0.08	±0.08	±0.08	±0.11	±0.16	—
F	±0.005	±0.013	±0.025	9.525	±0.08	±0.08	±0.08	±0.11	±0.16	—
C	±0.013	±0.025	±0.025	12.70	±0.13	±0.13	±0.13	±0.15	—	—
H	±0.013	±0.013	±0.025	15.875	±0.15	±0.15	±0.15	±0.18	—	—
E	±0.025	±0.025	±0.025	19.05	±0.15	±0.15	±0.15	±0.18	—	—
G	±0.025	±0.025	±0.13	25.40	—	±0.18	—	—	—	—
J	±0.005	±0.05—±0.15	±0.025	31.75	—	±0.20	—	—	—	—
K*	±0.013	±0.05—±0.15	±0.025	● Tolerance of Inscribed Circle (mm)						
L*	±0.025	±0.05—±0.15	±0.025	D.I.C.	Triangular	Square	Rhombic 80°	Rhombic 55°	Rhombic 35°	Round
M*	±0.08—±0.18	±0.05—±0.15	±0.13	6.35	±0.05	±0.05	±0.05	±0.05	±0.05	—
N*	±0.08—±0.18	±0.05—±0.15	±0.025	9.525	±0.05	±0.05	±0.05	±0.05	±0.05	±0.05
U*	±0.13—±0.38	±0.08—±0.25	±0.13	12.70	±0.08	±0.08	±0.08	±0.08	—	±0.08
The surface of inserts with a * mark is sintered.				15.875	±0.10	±0.10	±0.10	±0.10	—	±0.10
				19.05	±0.10	±0.10	±0.10	±0.10	—	±0.10
				25.40	—	±0.13	—	—	—	±0.13
				31.75	—	±0.15	—	—	—	±0.15

③ Symbol for Tolerance Class

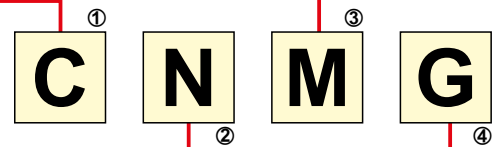

② Symbol for Normal Clearance		
Symbol	Normal Clearance	
A	3°	
B	5°	
C	7°	
D	15°	
E	20°	
F	25°	
G	30°	
N	0°	
P	11°	
O	Other Normal Clearance	
Major Normal Clearance		

④ Symbol for Fixing and / or for Chipbreaker									
Metric									
Symbol	Hole	Hole Configuration	Chip Breaker	Figure	Symbol	Hole	Hole Configuration	Chip Breaker	Figure
W	With Hole	Cylindrical Hole	No		A	With Hole	Cylindrical Hole	No	
T	With Hole	One Countersink (40—60°)	One Sided		M	With Hole	Cylindrical Hole	One Sided	
Q	With Hole	Cylindrical Hole	No		G	With Hole	Cylindrical Hole	Double Sided	
U	With Hole	Double Countersink (40—60°)	Double Sided		N	Without Hole	—	No	
B	With Hole	Cylindrical Hole	No		R	Without Hole	—	One Sided	
H	With Hole	One Countersink (70—90°)	One Sided		F	Without Hole	—	Double Sided	
C	With Hole	Cylindrical Hole	No		X	—	—	—	Special Design
J	With Hole	Double Countersink (70—90°)	Double Sided						

Symbol							Diameter of Inscribed Circle (mm)
R	W	V	D	C	S	T	
	02		04	03	03	06	3.97
	L3	08	05	04	04	08	4.76
	03	09	06	05	05	09	5.56
06							6.00
	04	11	07	06	06	11	6.35
	05	13	09	08	07	13	7.94
08							8.00
09	06	16	11	09	09	16	9.525
10							10.00
12							12.00
	08	22	15	12	12	22	12.70
15	10		19	16	15	27	15.875
16							16.00
19	13		23	19	19	33	19.05
20							20.00
			27	22	22	38	22.225
25							25.00
25			31	25	25	44	25.40
31			38	32	31	54	31.75
32							32.00

⑤ Symbol for Insert Size

*Thickness is from the bottom of the insert to the top of the cutting edge.

Symbol	Thickness (mm)
S1	1.39
01	1.59
T0	1.79
02	2.38
T2	2.78
03	3.18
T3	3.97
04	4.76
06	6.35
07	7.94
09	9.52

⑥ Symbol for Insert Thickness

12 04 08 (E) (N)-MP

⑦ Symbol for Insert Corner Size

Symbol	Corner Radius (mm)
00	Sharp Nose
V3	0.03
V5	0.05
01	0.1
02	0.2
04	0.4
08	0.8
12	1.2
16	1.6
20	2.0
24	2.4
28	2.8
32	3.2

00 : Inch
M0 : Metric

Round Insert

⑧ Symbol for Cutting Edge Type

Figure	Cutting Edge	Symbol
	Sharp Cutting Edges	F
	Round Cutting Edges	E
	Chamfered Cutting Edges	T
	Chamfered and Rounded Cutting Edges	S
-	(-) Corner R tolerance	M

Mitsubishi Materials omit the honing symbol.

⑨ Symbol for Cutting Direction

Figure	Hand	Symbol
	Right	R
	Left	L
	Neutral	N

⑩ Symbol for Chipbreaker

LP	MP	RP
LM	MM	RM
LK	MK	RK
LS	MS	RS
FP	LP	MP
MA	SW	MW
HZ	HX	HV

The table above is shown as reference example.

HOLE GEOMETRY

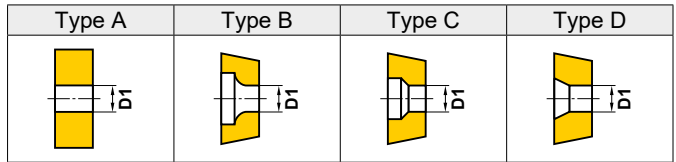

TURNING INSERTS

A

NEGATIVE

Insert Number	Dimension (mm)		Hole Type	
	D1			
CNGA CNGG CNGM CNMA CNMG CNMM CNMP	0903	3.81	A	
	09T3	3.81	A	
	0904	3.81	A	
	1204	5.16	A	
	1606	6.35	A	
	1906	7.93	A	
	2509	9.12	A	
	DNGA DNGG DNGM DNMA DNMG DNMM DNMX	1104	3.81	A
		1504	5.16	A
1506		5.16	A	
SNGA SNGG SNMA SNMG SNMM		0903	3.81	A
		1204	5.16	A
		1506	6.35	A
	1906	7.93	A	
	2507	9.12	A	
2509	9.12	A		
TNGA TNGG TNGM TNMA TNMG TNMM TNMX	1103	2.26	A	
	1603	3.81	A	
	1604	3.81	A	
	2204	5.16	A	
	2706	6.35	A	
	3309	7.93	A	
	VNGA VNGM VNGG VNMA VNMG VNMM	1604	3.81	A
		WNGA WNMA WNMG	0603	3.81
06T3			3.81	A
0604			3.81	A
0804			5.16	A
1006			6.35	A
RNMG	090300	3.81	A	
	120400	5.16	A	
	150600	6.35	A	
	190600	7.93	A	
	250900	9.12	A	
	310900	12.7	A	

POSITIVE

Insert Number	Dimensions (mm)		Hole Type	
	D1			
CCET	0602	2.8	B	
	09T3	4.4	B	
CCGB CCMB CCGH CCMH	0602	2.8	B	
	CCGT	03S1	2.0	B
		04T0	2.4	B
		0602	2.8	B
09T3		4.4	B	
CCMT	1204	5.5	B	
	0602	2.8	B	
	0803	3.4	B	
	09T3	4.4	B	
CCGW CCMW	1204	5.5	B	
	03S1	2.0	B	
	04T0	2.4	B	
	0602	2.8	B	
	09T3	4.4	B	
CPGT	1204	5.5	B	
	0802	3.4	B	
CPGB CPMB CPMH	0903	4.4	B	
	0802	3.5	D	
	0903	4.5	D	
CPMX	0802	3.5	D	
	0903	4.6	D	
DCET DCGT	0702	2.8	B	
	11T3	4.4	B	
DCGW DCMW DCMT	0702	2.8	B	
	11T3	4.4	B	
	1504	5.5	B	
DEGX	1504	5.1	C	
RCMX	1003M0	3.6	D	
	1204M0	4.2	D	
	1606M0	5.2	D	
	2006M0	6.5	D	
	3209M0	9.5	D	

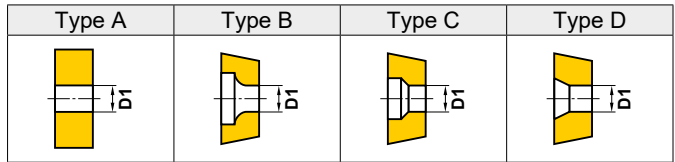

POSITIVE

Insert Number		Dimensions (mm)	
		D1	Hole Type
RCGT RCMT	0602M0	2.8	B
	0803M0	3.4	B
	10T3M0	4.4	B
SCMT SCMW	09T3 $\odot\odot$	4.4	B
	1204 $\odot\odot$	5.5	B
SPMW	0903 $\odot\odot$	4.6	B
	1203 $\odot\odot$	5.7	B
SPMT	0903 $\odot\odot$	4.4	B
	1203 $\odot\odot$	5.5	B
SPGX	0903 $\odot\odot$	4.8	D
	1203 $\odot\odot$	5.9	D
TCGT TCMT TCGW TCMW	0601 $\odot\odot$	2.3	B
	0802 $\odot\odot$	2.3	B
	0902 $\odot\odot$	2.5	B
	1102 $\odot\odot$	2.8	B
	1303 $\odot\odot$	3.4	B
16T3 $\odot\odot$	4.4	B	
TEGX	1603 $\odot\odot$	4.4	D
TPGX	0802 $\odot\odot$	2.5	C
	0902 $\odot\odot$	3.0	C
	1103 $\odot\odot$	3.5	C
	1603 $\odot\odot$	4.8	D
TPMX	0802 $\odot\odot$	2.7	C
	0902 $\odot\odot$	3.2	C
	1103 $\odot\odot$	3.7	C
	1103 $\odot\odot$ L	3.5	C
	1603 $\odot\odot$	4.8	D
TPGB TPMB TPGH TPMH	0802 $\odot\odot$	2.4	D
	0902 $\odot\odot$	2.9	D
	1103 $\odot\odot$	3.4	D
	1603 $\odot\odot$	4.4	D
TPGT	1603 $\odot\odot$	4.4	B
TPGV	0902 $\odot\odot$	2.8	B
	1103 $\odot\odot$	3.4	B

Insert Number		Dimensions (mm)	
		D1	Hole Type
VBET VBGT VBMT VBGW	1103 $\odot\odot$	2.9	B
	1604 $\odot\odot$	4.4	B
VCGT VCMT VCGW VCMW	0802 $\odot\odot$	2.4	B
	1103 $\odot\odot$	2.8	B
	1303 $\odot\odot$	3.4	B
	1604 $\odot\odot$	4.4	B
VDGX	1603 $\odot\odot$	4.5	D
VPET VPGT	0802 $\odot\odot$	2.42	B
	1103 $\odot\odot$	2.85	B
WBGT WBMT	0201 $\odot\odot$	2.3	B
	L302 $\odot\odot$	2.3	B
WCGT WCMT WCGW WCMW	0201 $\odot\odot$	2.3	B
	L302 $\odot\odot$	2.3	B
	0402 $\odot\odot$	2.8	B
	06T3 $\odot\odot$	4.4	B
WPGT WPMT	0402 $\odot\odot$	2.8	B
	0603 $\odot\odot$	4.4	B
XCMT	1503 $\odot\odot$	2.8	B

A

TURNING INSERTS

PRECISION BREAKER SYSTEM



STANDARD OF INSERTS WITH HAND OF TOOL

● NEGATIVE INSERTS

Unit : mm



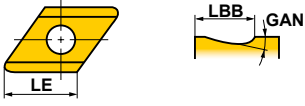
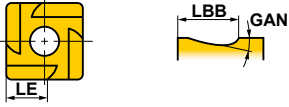
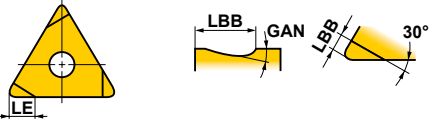
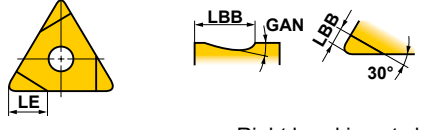
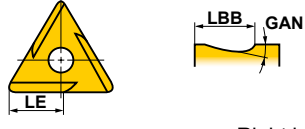
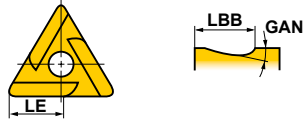







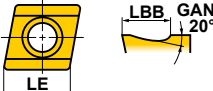

TURNING INSERTS

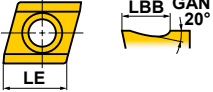
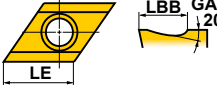
A

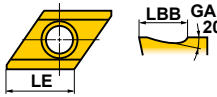
Geometry	Insert Number	LBB	LE	GAN
 <p>Right hand insert shown.</p>	DNGG150404R/L	2.8	14.9	15°
	DNGG150408R/L	2.8	14.3	15°
	DNGG150604R/L	2.8	14.9	15°
	DNGG150608R/L	2.8	14.3	15°
 <p>Right hand insert shown.</p>	SNGG090304R/L	1.8	1.6	15°
	SNGG090308R/L	1.8	1.6	15°
	SNGG120404R/L	2.3	3.7	15°
	SNGG120408R/L	2.3	3.7	15°
 <p>Right hand insert shown.</p>	TNGG160402R/L-FS	1.3	2.7	15°
	TNGG160404R/L-FS	1.3	2.8	15°
	TNGG160408R/L-FS	1.3	3.1	15°
 <p>Right hand insert shown.</p>	TNGG160402R/L-F	2.5	5.1	15°
	TNGG160404R/L-F	2.5	5.2	15°
	TNGG160408R/L-F	2.5	5.5	15°
 <p>Right hand insert shown.</p>	TNGG160402R/L-K	1.5	7.1	15°
	TNGG160404R/L-K	1.5	5.4	15°
	TNGG160408R/L-K	1.5	5.1	15°
 <p>Right hand insert shown.</p>	TNGG110302R/L	1.3	3.2	15°
	TNGG110304R/L	1.3	3.0	15°
	TNGG110308R/L	1.3	2.7	15°
	TNGG160304R/L	2.3	5.4	15°
	TNGG160402R/L	1.3	8.7	15°
	TNGG160404R/L	2.3	5.4	15°
	TNGG160408R/L	2.3	5.1	15°
	TNGG220404R/L	2.8	9.4	15°
TNGG220408R/L	2.8	9.1	15°	
 <p>Right hand insert shown.</p>	VNGG160404R/L	1.8	15.6	15°
	 <p>Right hand insert shown.</p>	VNGG160402R/L-F	2.5	7.4
VNGG160404R/L-F		2.5	7.6	15°

● POSITIVE INSERTS

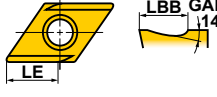
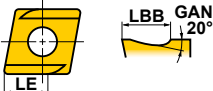
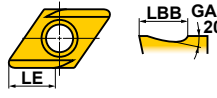
Unit : mm

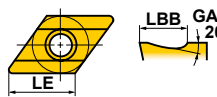
Geometry	Insert Number	LBB	LE	Geometry	Insert Number	LBB	LE
 <p>Right hand insert shown.</p>	CCET0602V3R/L-SR	2.2	6.4	 <p>Right hand insert shown.</p>	DCGT11T301MR-SRF	1.0	3.1
	CCET060201R/L-SR	2.2	6.3		DCGT11T302MR-SRF	1.0	3.2
	CCET060202R/L-SR	2.2	6.2		DCGT11T304MR-SRF	1.0	3.4
	CCET060204R/L-SR	2.2	6.0				
	CCET09T3V3R/L-SR	3.2	9.6				
	CCET09T301R/L-SR	3.2	9.5				
	CCET09T302R/L-SR	3.2	9.4				
	CCET09T304R/L-SR	3.2	9.2				
 <p>Right hand insert shown.</p>	CCET060200R/L-SN	1.0	6.4	 <p>Right hand insert shown.</p>	DCET0702V3R/L-SR	2.5	7.7
	CCET0602V3R/L-SN	1.0	6.4		DCET070201R/L-SR	2.5	7.6
	CCET060201R/L-SN	1.0	6.3		DCET070202R/L-SR	2.5	7.4
	CCET060202R/L-SN	1.0	6.2		DCET070204R/L-SR	2.5	7.1
	CCET060204R/L-SN	1.0	6.0		DCET11T3V3R/L-SR	3.7	11.6
	CCET09T300R/L-SN	1.5	9.6		DCET11T301R/L-SR	3.7	11.4
	CCET09T3V3R/L-SN	1.5	9.6		DCET11T302R/L-SR	3.7	11.3
	CCET09T301R/L-SN	1.5	9.5		DCET11T304R/L-SR	3.7	11.0
	CCET09T302R/L-SN	1.5	9.4				
	CCET09T304R/L-SN	1.5	9.2				
 <p>Right hand insert shown.</p>	CCET0602V3R/LW-SN	1.0	6.4	 <p>Right hand insert shown.</p>	DCET070200R/L-SN	1.0	7.7
	CCET09T3V3R/LW-SN	1.5	9.6		DCET0702V3R/L-SN	1.0	7.7
 <p>Right hand insert shown.</p>	CCGH060202(M)R/L-F	1.2	3.6	 <p>Right hand insert shown.</p>	DCET070201R/L-SN	1.0	7.6
	CCGH060204(M)R/L-F	1.4	4.4		DCET070202R/L-SN	1.0	7.4
 <p>Left hand insert shown.</p>	CCGT03S1V3L-F	0.8	1.4	 <p>Left hand insert shown.</p>	DCET070204R/L-SN	1.0	7.1
	CCGT03S101(M)R/L-F	0.8	1.4		DCET070204R/L-F	1.0	3.2
	CCGT03S102(M)R/L-F	0.8	1.5		DCGT11T302R/L-F	1.0	3.0
	CCGT03S104(M)R/L-F	0.8	1.6		DCGT11T304R/L-F	1.0	3.2
	CCGT04T0V3L-F	1.0	1.7				
	CCGT04T001(M)R/L-F	1.0	1.8				
	CCGT04T002(M)R/L-F	1.0	1.8				
	CCGT04T004(M)R/L-F	1.0	2.0				
 <p>Right hand insert shown.</p>	CCGT0602V3R/L-SS	1.0	3.0	 <p>Right hand insert shown.</p>	DCGT070202R/L-F	1.0	3.0
	CCGT060201(M)R/L-SS	1.0	3.0		DCGT070202R/L-SS	1.0	3.5
	CCGT060202(M)R/L-SS	1.0	3.0		DCGT11T3V3R-SS	1.0	6.5
	CCGT09T3V3R/L-SS	1.0	5.0		DCGT11T301(M)R/L-SS	1.0	6.5
	CCGT09T301(M)R/L-SS	1.0	5.0		DCGT11T302(M)R/L-SS	1.0	6.5
	CCGT09T302(M)R/L-SS	1.0	5.0		DCGT11T304MR/L-SS	1.0	6.5
	CCGT09T304MR/L-SS	1.0	5.0				
 <p>Right hand insert shown.</p>	CCGT0602V3R-SN	1.0	3.0	 <p>Right hand insert shown.</p>	DCGT0702V3R-L-SS	1.0	3.5
	CCGT060201(M)R/L-SN	1.0	3.0		DCGT070201R/L-SS	1.0	3.5
	CCGT060202(M)R/L-SN	1.0	3.0		DCGT070202(M)R/L-SN	1.0	3.5
	CCGT09T3V3R/L-SN	1.5	5.0		DCGT11T3V3R/L-SN	1.5	6.5
	CCGT09T301(M)R/L-SN	1.5	5.0		DCGT11T301(M)R/L-SN	1.5	6.5
	CCGT09T302(M)R/L-SN	1.5	5.0		DCGT11T302(M)R/L-SN	1.5	6.5
	CCGT09T304(M)R/L-SN	1.5	5.0		DCGT11T304(M)R/L-SN	1.5	6.5
 <p>Right hand insert shown.</p>	CPGT080204R/L-F	1.8	5.5	 <p>Right hand insert shown.</p>	DEGX150402R/L	2.8	15.2
	CPGT090302R/L-F	1.8	5.4		DEGX150404R/L	2.8	14.9
	CPGT090304R/L-F	1.8	5.5				

TURNING INSERTS

A

PRECISION BREAKER SYSTEM











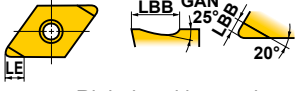
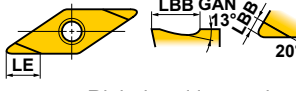

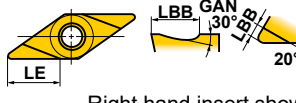
STANDARD OF INSERTS WITH HAND OF TOOL

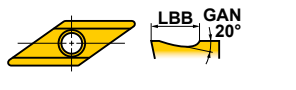
● POSITIVE INSERTS

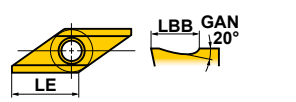
Unit : mm

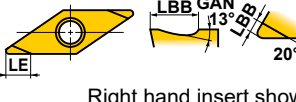
TURNING INSERTS

A

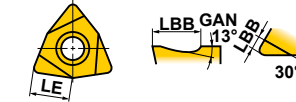
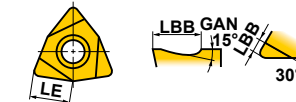
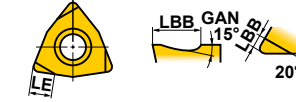
Geometry	Insert Number	LBB	LE	Geometry	Insert Number	LBB	LE
 Right hand insert shown.	DEGX150402R/L-F DEGX150404R/L-F	2.5 2.5	7.4 7.6	 Right hand insert shown.	VBGT110302R/L-F VBGT110304R/L-F VBGT160402R/L-F VBGT160404R/L-F	1.0 1.0 1.5 1.5	3.0 3.2 4.5 4.7
 Right hand insert shown.	SPGR090304R	1.8	1.6	 Right hand insert shown.	VBET1103V3R/L-SR VBET110301R/L-SR VBET110302R/L-SR VBET110304R/L-SR	2.5 2.5 2.5 2.5	7.3 7.3 7.4 7.6
 Left hand insert shown.	TCGT0601V3L-F TCGT060101L-F TCGT060102R/L-F TCGT060104R/L-F	1.0 1.0 1.0 1.0	2.9 3.0 3.0 3.2	 Right hand insert shown.	VBET110300R/L-SN VBET1103V3R/L-SN VBET110301R/L-SN VBET110302R/L-SN VBET110304R/L-SN	1.0 1.0 1.0 1.0 1.0	11.0 11.0 10.8 10.5 11.0
 Right hand insert shown.	TEGX160302R/L TEGX160304R/L	2.0 2.0	6.0 6.0	 Right hand insert shown.	VBET1103V3R/LW-SN	1.0	11.0
 Right hand insert shown.	TPGH080202R/L-FS TPGH080204R/L-FS TPGH090202R/L-FS TPGH090204R/L-FS TPGH110302R/L-FS TPGH110304R/L-FS TPGH160304R/L-FS TPGH160308R/L-FS	0.9 0.9 1.0 1.0 1.4 1.4 2.0 2.0	2.7 2.9 3.0 3.2 4.2 4.4 6.1 6.5	 Right hand insert shown.	VCGT080202R/L-F VCGT080204R/L-F	0.8 0.8	2.5 2.6
 Right hand insert shown.	TPGR110304R/L TPGR160304R/L TPGR160308R/L	1.3 2.3 2.3	3.0 5.4 5.1	 Right hand insert shown.	VDBG160302R/L VDBG160304R/L	2.0 2.0	6.0 6.1
 Right hand insert shown.	TPGX080202R/L TPGX080204R/L TPGX090202R/L TPGX090204R/L TPGX090208R/L TPGX110302L TPGX110304R/L TPGX110308R/L	1.3 1.3 1.6 1.6 1.4 1.8 1.8 1.8	3.9 4.1 4.8 5.0 4.7 5.4 5.5 5.9	 Left hand insert shown.	VPET080201R/L-SRF VPET080202R/L-SRF VPET1103V3R/L-SRF VPET110301R/L-SRF VPET110302R/L-SRF	0.8 0.8 1.0 1.0 1.0	2.4 2.5 2.9 3.0 3.0
				 Right hand insert shown.	WBGTL302V3L-F WBGTL30201L-F WBGTL30202R/L-F WBGTL30204R/L-F	1.0 1.0 1.0 1.0	2.0 2.1 2.1 2.2
				 Right hand insert shown.	WCGT020102R/L WCGT020104R/L WCGTL30202L WCGTL30204L	1.0 1.0 1.0 1.0	2.1 2.2 2.1 2.2
					WPGT040204R/L-FS WPGT060304R/L-FS	1.0 1.0	3.2 3.2

TOOL NAVI

OUTLINE

TOOL NAVI provides information and suitable cutting conditions for each work material by selecting the optimum indexable insert together with a suitable tool life expectancy.

LABEL INDICATION

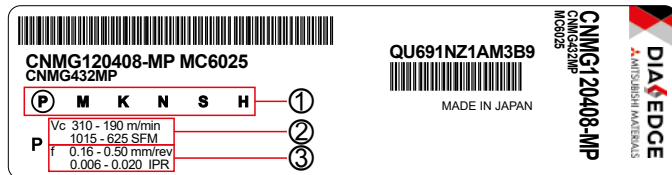

- *1 Some inserts will have multiple material recommendations.
- *2 Please contact us for recommended cutting conditions when using coefficient values other than above.

① Work materials

- P** : Steel (Reference material : Carbon steel, alloy steel 180HB)
- M** : Stainless steel (Reference material : Austenitic stainless steel 180HB)
- K** : Cast iron (Reference material : Gray cast iron, ductile cast iron 180HB)
- N** : Aluminium alloy, non-ferrous metals
- S** : Reference material : Titanium alloy 320HB, Ni, Co-Based alloy 400HB
- H** : Hardened steel 60HRC

② Cutting speed standards (Performance versus tool life)

Work Material	Tool Life		Material	Hardness
	Life	Performance		
P	90min	15min	Carbon steel, alloy steel	180HB
M	90min	15min	Stainless steel	180HB
K	90min	15min	Cast iron	180HB
S	25min	5min	Titanium alloy	320HB
			Ni, Co-Based Alloy	400HB
H	80min	10min	Hardened steel	60HRC

- *3 N : Life based on each grade. For stable conditions choose the performance cutting speed, for unstable conditions choose the tool life feed rate.
- *4 The tool life is based on the following (VB wear). Some materials include elements other than this.
 PMKS ... VB=0.3mm
 H 181 ... VB=0.1mm

③ Feed rate standards

Minimum and maximum feed rates shown are based on the chip control range and are dependant on the chipbreaker geometry.

TOOL LIFE

Cutting speed has a large effect on tool life. TOOL NAVI is based on Taylor's equation (relationship $V_c T^n = C$ between tool grade, cutting conditions, and tool life). Therefore, performance speed and tool life is found for each work material. When a different tool life is required, obtain coefficient values of the grade used from the charts below. Multiply the coefficient values by the cutting speed to calculate a new cutting speed.

● P Grade (Steel) cutting speed coefficient values.

Grade	Tool life	15min	30min	45min	60min	90min
UE6105		1.00	0.79	0.69	0.63	0.55
MC6015 MC6115		1.00	0.82	0.72	0.67	0.59
MC6025 MC6125		1.00	0.83	0.75	0.69	0.62
MC6035		1.00	0.88	0.82	0.78	0.73
MP3025		1.00	0.85	0.77	0.72	0.65
NX2525		1.00	0.87	0.80	0.76	0.70

● K Grade (Cast Iron) cutting speed coefficient values.

Grade	Tool life	15min	30min	45min	60min	90min
MC5005		1.00	0.83	0.75	0.70	0.63
MC5015		1.00	0.83	0.75	0.69	0.62

(ex.) Medium cutting of steel
 The 1st recommendation : MC6025
 Indexable inserts : CNMG120408-MP
 Recommended cutting speed : $V_c=310\text{m/min}$
 (Tool life : 15min.)



Tool life required : 30min.

$$310 \times 0.83 \approx 257\text{m/min}$$

● M Grade (Stainless Steel) cutting speed coefficient values.

Grade	Tool life	15min	30min	45min	60min	90min
MC7015		1.00	0.83	0.75	0.70	0.63
MC7025		1.00	0.90	0.84	0.80	0.75
MP7035		1.00	0.84	0.76	0.71	0.62
US735		1.00	0.78	0.68	0.61	0.53

HARDNESS OF THE WORK MATERIAL

Hardness of the work material also affects tool life. Mitsubishi's TOOL NAVI suggests cutting speed variations when material hardness differs. Obtain the suitable coefficient value for each type of work material from the chart below. Multiply the coefficient value by the recommended cutting speed of the grade used to calculate a new cutting speed.

Work material	(Hardness of workpiece)												
	Soft	120HB	140HB	160HB	180HB	200HB	220HB	240HB	260HB	280HB	300HB	320HB	340HB
P	1.34	1.19	1.08	1.00	0.92	0.85	0.80	0.75	0.71	0.68	0.64	0.61	0.61
M	1.41	1.23	1.10	1.00	0.91	0.85	0.78	0.72	0.68	0.64	0.61	0.58	0.58
K	1.27	1.19	1.09	1.00	0.97	0.91	0.88	0.85	0.81	0.78	0.75	0.72	0.72

OPTIMUM GRADES AND CHIPBREAKERS FOR EXTERNAL TURNING

● Selection of optimum inserts for turning

The following diagrams show for each type of work material, the optimal combination of suitable grades and chipbreakers for each application area in turning.

TURNING INSERTS

■ CUTTING CONDITIONS

- Stable Cutting
 - Continuous Cutting
 - Constant Depth of Cut
 - Pre-Machined
 - Securely Clamped Component Cutting
- General Cutting
- ⊕ Unstable Cutting
 - Heavy Interrupted Cutting
 - Irregular Depth of Cut
 - Low Clamping Rigidity Cutting

■ CUTTING AREA

- F** Finish Cutting
- L** Light Cutting
- M** Medium Cutting
- R** Rough Cutting
- H** Heavy Cutting

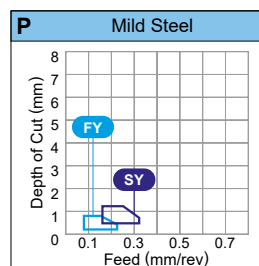
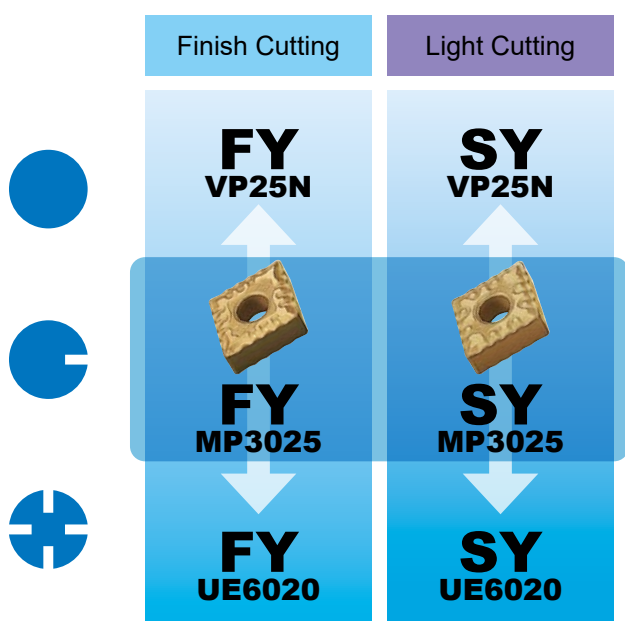

P Mild Steel* (ex. St37-2, Ck10) NEGATIVE INSERTS

Vc : Cutting Speed
f : Feed
ap : Depth of Cut

	Cutting Area	Chipbreaker	Grade	1st Recommendation		
				Vc (m/min)	f (mm/rev)	ap (mm)
● Stable Cutting	F	FY	VP25N	285-450	0.09-0.23	0.20-0.80
	L	SY	VP25N	260-410	0.16-0.33	0.50-1.20
● General Cutting	F	FY	MP3025	275-425	0.09-0.23	0.20-0.80
	L	SY	MP3025	255-385	0.16-0.33	0.50-1.20
⊕ Unstable Cutting	F	FY	UE6020	285-465	0.09-0.23	0.20-0.80
	L	SY	UE6020	260-425	0.16-0.33	0.50-1.20

*Please refer to page A074 for other steels.

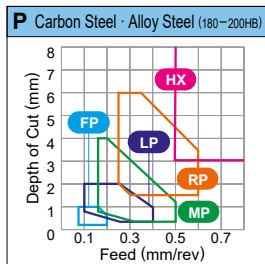

- Stable Cutting
- General Cutting
- Unstable Cutting

- F** Finish Cutting
- L** Light Cutting
- M** Medium Cutting
- R** Rough Cutting
- H** Heavy Cutting

	Finish Cutting	Light Cutting	Medium Cutting	Rough Cutting	Heavy Cutting
<div style="display: flex; flex-direction: column; align-items: center; gap: 20px;"> ● ◐ ⊕ </div>	FP NX2525	LP MC6115	MP MC6115	RP MC6115	HX MC6025
	FP MP3025	LP MC6115	MP MC6125	RP MC6125	HX MC6025
	FP MC6025	LP MC6125	MP MC6125	RP MC6125	HX MC6035

P Carbon Steel • Alloy Steel* (ex. Ck45, 42CrMo4) Vc : Cutting Speed
f : Feed
ap : Depth of Cut

	Cutting Area	Chipbreaker	Grade	1st Recommendation		
				Vc (m/min)	f (mm/rev)	ap (mm)
<div style="display: flex; flex-direction: column; align-items: center; gap: 20px;"> ● </div> Stable Cutting	F	FP	NX2525	210-300	0.08-0.25	0.10-1.00
	L	LP	MC6115	250-480	0.10-0.40	0.30-2.00
	M	MP	MC6115	230-440	0.16-0.50	0.30-4.00
	R	RP	MC6115	215-415	0.25-0.60	1.50-6.00
	H	HX	MC6025	165-265	0.50-1.26	3.00-11.00
<div style="display: flex; flex-direction: column; align-items: center; gap: 20px;"> ◐ </div> General Cutting	F	FP	MP3025	215-330	0.08-0.25	0.10-1.00
	L	LP	MC6115	250-480	0.10-0.40	0.30-2.00
	M	MP	MC6125	250-390	0.16-0.50	0.30-4.00
	R	RP	MC6125	235-370	0.25-0.60	1.50-6.00
	H	HX	MC6025	165-265	0.50-1.26	3.00-11.00
<div style="display: flex; flex-direction: column; align-items: center; gap: 20px;"> ⊕ </div> Unstable Cutting	F	FP	MC6025	230-375	0.08-0.25	0.10-1.00
	L	LP	MC6125	275-425	0.10-0.40	0.30-2.00
	M	MP	MC6125	250-390	0.16-0.50	0.30-4.00
	R	RP	MC6125	235-370	0.25-0.60	1.50-6.00
	H	HX	MC6035	140-200	0.50-1.26	3.00-11.00

*Please refer to page A074 for other steels.

OPTIMUM GRADES AND CHIPBREAKERS FOR EXTERNAL TURNING

TURNING INSERTS

A

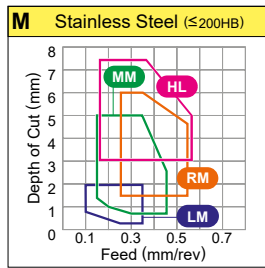

- Stable Cutting
- General Cutting
- Unstable Cutting

- L** Light Cutting
- M** Medium Cutting
- R** Rough Cutting
- H** Heavy Cutting

	Light Cutting	Medium Cutting	Rough Cutting	Heavy Cutting
	LM MC7015	MM MC7015	RM MC7015	HL US735
	LM MC7025	MM MC7025	RM MC7025	HL US735
	LM MP7035	MM MP7035	RM MP7035	HL US735

M Stainless Steel* (ex. X5CrNi189, X5CrNiMo1810) NEGATIVE INSERTS

Vc : Cutting Speed
f : Feed
ap : Depth of Cut

	Cutting Area	Chipbreaker	Grade	1st Recommendation		
				Vc (m/min)	f (mm/rev)	ap (mm)
	L	LM	MC7015	180–285	0.10–0.30	0.30–2.00
	M	MM	MC7015	165–260	0.15–0.45	0.70–5.00
	R	RM	MC7015	155–245	0.25–0.55	1.50–6.00
	H	HL	US735	75–140	0.40–1.00	1.50–8.00
	L	LM	MC7025	165–220	0.10–0.30	0.30–2.00
	M	MM	MC7025	150–200	0.15–0.45	0.70–5.00
	R	RM	MC7025	140–190	0.25–0.55	1.50–6.00
	H	HL	US735	75–140	0.40–1.00	1.50–8.00
	L	LM	MP7035	95–155	0.10–0.30	0.30–2.00
	M	MM	MP7035	90–145	0.15–0.45	0.70–5.00
	R	RM	MP7035	85–135	0.25–0.55	1.50–6.00
	H	HL	US735	75–140	0.40–1.00	1.50–8.00

*Please refer to page A078 for other stainless steel.

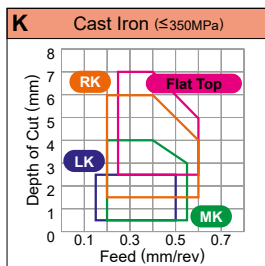

- Stable Cutting
- General Cutting
- Unstable Cutting
- Light Cutting
- Medium Cutting
- Rough Cutting
- Heavy Cutting



K Cast Iron* (ex. GG30)
NEGATIVE INSERTS

V_c : Cutting Speed
f : Feed
a_p : Depth of Cut

	Cutting Area	Chipbreaker	Grade	1st Recommendation		
				V _c (m/min)	f (mm/rev)	a _p (mm)
 Stable Cutting	L	LK	MC5005	230–365	0.10–0.40	0.30–2.00
	M	MK	MC5005	210–335	0.20–0.55	1.00–4.00
	R	RK	MC5005	195–315	0.25–0.60	1.50–6.00
	H	Flat Top	MC5005	195–315	0.20–0.60	2.50–6.00
 General Cutting	L	LK	MC5015	205–335	0.10–0.40	0.30–2.00
	M	MK	MC5015	190–305	0.20–0.55	1.00–4.00
	R	RK	MC5015	180–285	0.25–0.60	1.50–6.00
	H	Flat Top	MC5015	180–285	0.20–0.60	2.50–6.00
 Unstable Cutting	L	LK	MC5015	205–335	0.10–0.40	0.30–2.00
	M	MK	MC5015	190–305	0.20–0.55	1.00–4.00
	R	RK	MC5015	180–285	0.25–0.60	1.50–6.00
	H	Flat Top	MC5015	180–285	0.20–0.60	2.50–6.00

*Please refer to page A083 for other types of cast iron.

OPTIMUM GRADES AND CHIPBREAKERS FOR EXTERNAL TURNING

TURNING INSERTS

A

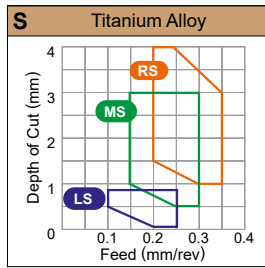

- Stable Cutting
- General Cutting
- Unstable Cutting
- Finish Cutting
- Light Cutting
- Medium Cutting
- Rough Cutting

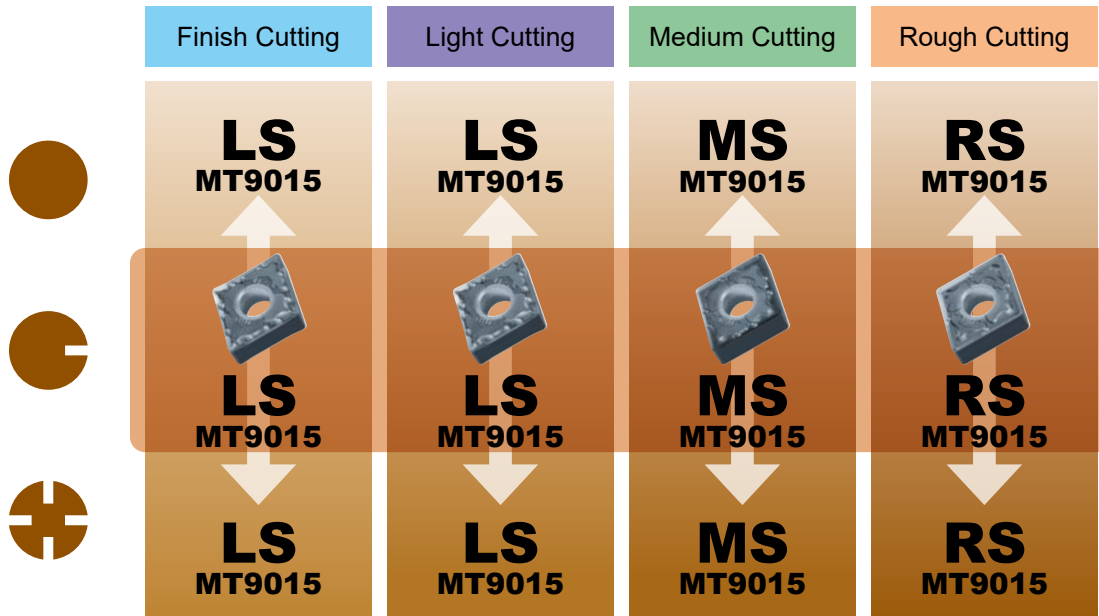

S Titanium Alloy (ex. Ti-6Al-4V)
NEGATIVE INSERTS

Vc : Cutting Speed
f : Feed
ap : Depth of Cut

	Cutting Area	Chipbreaker	Grade	1st Recommendation		
				Vc (m/min)	f (mm/rev)	ap (mm)
	F	LS	MT9015	40-85	0.10-0.25	0.20-0.80
	L	LS	MT9015	40-85	0.10-0.25	0.20-0.80
	M	MS	MT9015	40-80	0.15-0.30	0.50-3.00
	R	RS	MT9015	35-75	0.20-0.35	1.00-4.00
	F	LS	MT9015	40-85	0.10-0.25	0.20-0.80
	L	LS	MT9015	40-85	0.10-0.25	0.20-0.80
	M	MS	MT9015	40-80	0.15-0.30	0.50-3.00
	R	RS	MT9015	35-75	0.20-0.35	1.00-4.00
	F	LS	MT9015	40-85	0.10-0.25	0.20-0.80
	L	LS	MT9015	40-85	0.10-0.25	0.20-0.80
	M	MS	MT9015	40-80	0.15-0.30	0.50-3.00
	R	RS	MT9015	35-75	0.20-0.35	1.00-4.00

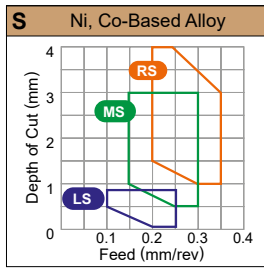

- Stable Cutting
- General Cutting
- Unstable Cutting
- F** Finish Cutting
- L** Light Cutting
- M** Medium Cutting
- R** Rough Cutting

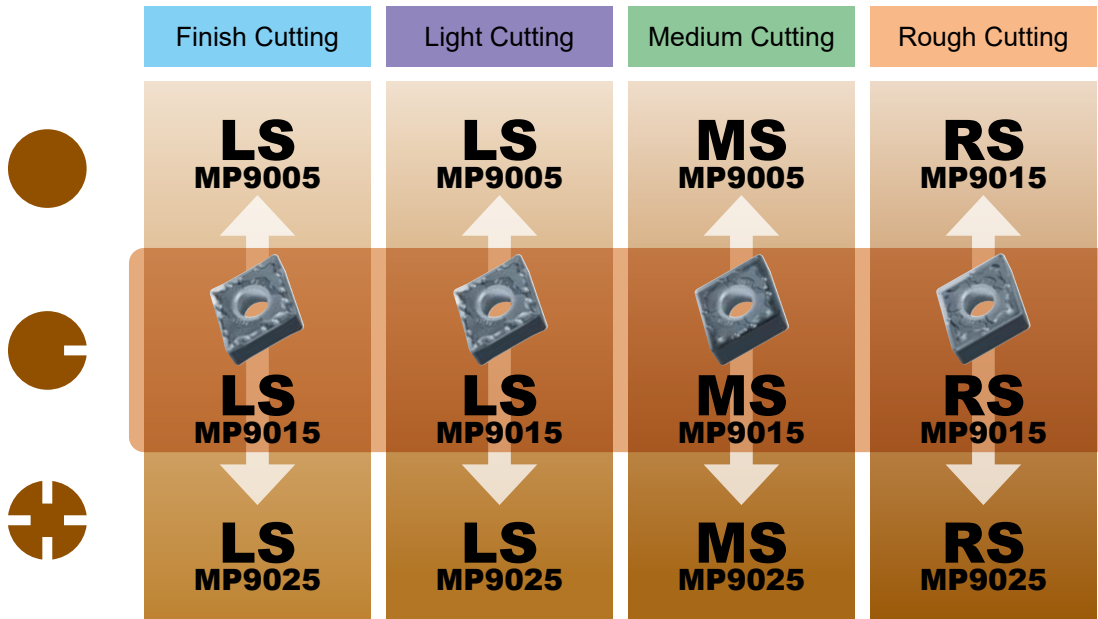

S Ni, Co-Based Alloy (ex. Inconel®718)
NEGATIVE INSERTS

Vc : Cutting Speed
f : Feed
ap : Depth of Cut

	Cutting Area	Chipbreaker	Grade	1st Recommendation		
				Vc (m/min)	f (mm/rev)	ap (mm)
	F	LS	MP9005	30-110	0.10-0.25	0.20-0.80
	L	LS	MP9005	30-110	0.10-0.25	0.20-0.80
	M	MS	MP9005	30-100	0.15-0.30	0.50-3.00
	R	RS	MP9015	20-75	0.20-0.35	1.00-4.00
	F	LS	MP9015	25-85	0.10-0.25	0.20-0.80
	L	LS	MP9015	25-85	0.10-0.25	0.20-0.80
	M	MS	MP9015	25-80	0.15-0.30	0.50-3.00
	R	RS	MP9015	20-75	0.20-0.35	1.00-4.00
	F	LS	MP9025	20-30	0.10-0.25	0.20-0.80
	L	LS	MP9025	20-30	0.10-0.25	0.20-0.80
	M	MS	MP9025	20-30	0.15-0.30	0.50-3.00
	R	RS	MP9025	15-25	0.20-0.35	1.00-4.00

OPTIMUM GRADES AND CHIPBREAKERS FOR EXTERNAL TURNING

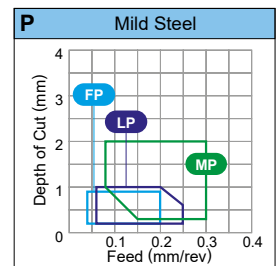
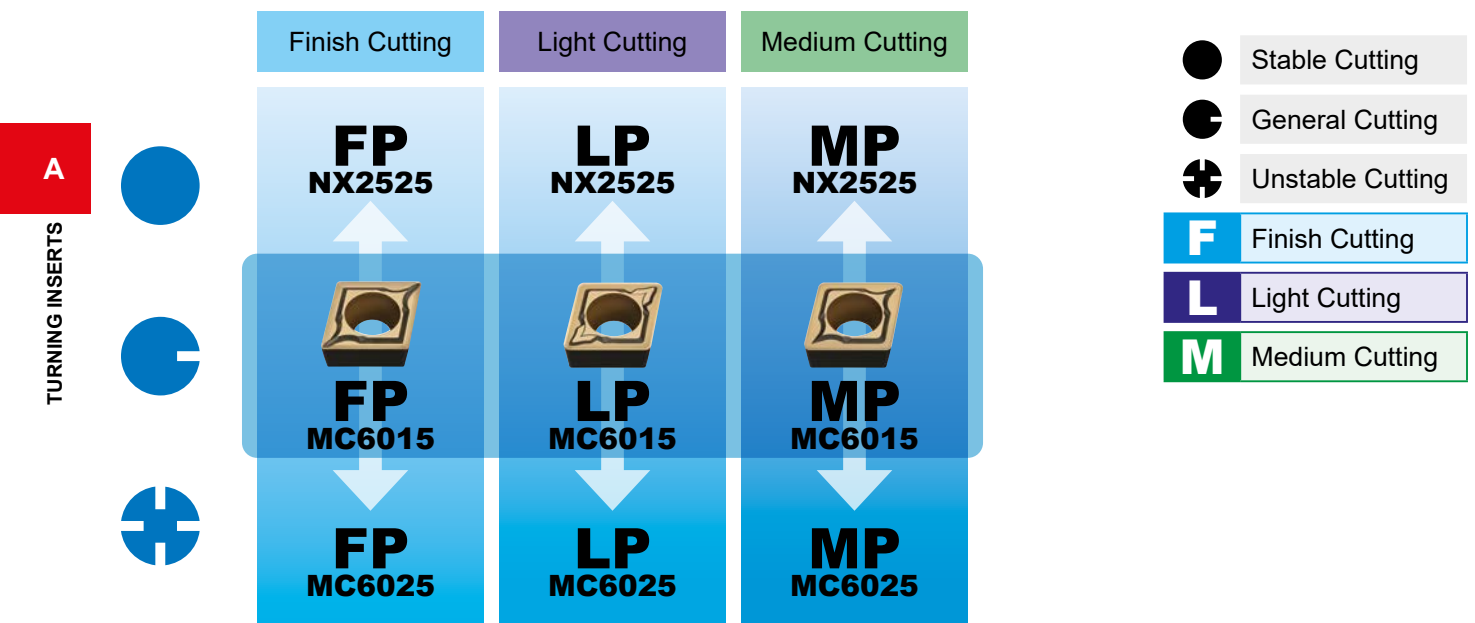

P Mild Steel* (ex. St37-2, Ck10) 7° POSITIVE INSERTS WITH HOLE

V_c : Cutting Speed
f : Feed
ap : Depth of Cut

	Cutting Area	Chipbreaker	Grade	1st Recommendation		
				V _c (m/min)	f (mm/rev)	ap (mm)
Stable Cutting	F	FP	NX2525	225–320	0.04–0.20	0.20–0.90
	L	LP	NX2525	225–320	0.06–0.25	0.20–1.00
	M	MP	NX2525	185–270	0.08–0.30	0.30–2.00
General Cutting	F	FP	MC6015	250–425	0.04–0.20	0.20–0.90
	L	LP	MC6015	250–425	0.06–0.25	0.20–1.00
	M	MP	MC6015	210–355	0.08–0.30	0.30–2.00
Unstable Cutting	F	FP	MC6025	250–405	0.04–0.20	0.20–0.90
	L	LP	MC6025	250–405	0.06–0.25	0.20–1.00
	M	MP	MC6025	210–340	0.08–0.30	0.30–2.00

*Please refer to page A087 for other steel.

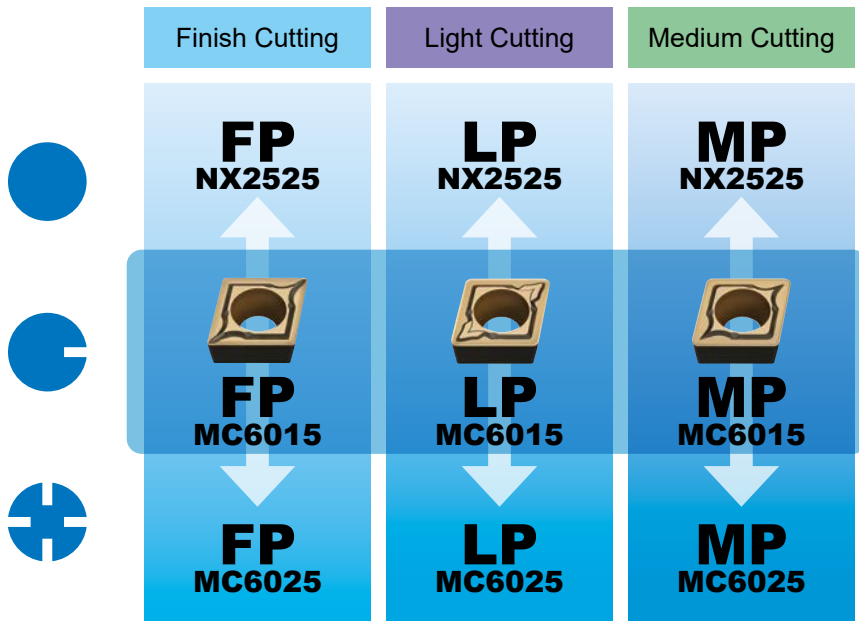

- Stable Cutting
- General Cutting
- Unstable Cutting
- F** Finish Cutting
- L** Light Cutting
- M** Medium Cutting

A
TURNING INSERTS

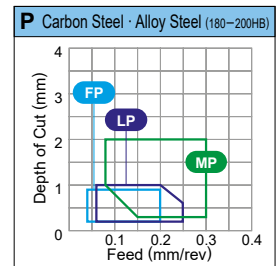

P Carbon Steel · Alloy Steel* (ex. Ck45, 42CrMo4)
7° POSITIVE INSERTS WITH HOLE

Vc : Cutting Speed
f : Feed
ap : Depth of Cut

	Cutting Area	Chipbreaker	Grade	1st Recommendation		
				Vc (m/min)	f (mm/rev)	ap (mm)
Stable Cutting	F	FP	NX2525	165-240	0.04-0.20	0.20-0.90
	L	LP	NX2525	165-240	0.06-0.25	0.20-1.00
	M	MP	NX2525	140-200	0.08-0.30	0.30-2.00
General Cutting	F	FP	MC6015	185-315	0.04-0.20	0.20-0.90
	L	LP	MC6015	185-315	0.06-0.25	0.20-1.00
	M	MP	MC6015	155-260	0.08-0.30	0.30-2.00
Unstable Cutting	F	FP	MC6025	185-300	0.04-0.20	0.20-0.90
	L	LP	MC6025	185-300	0.06-0.25	0.20-1.00
	M	MP	MC6025	155-250	0.08-0.30	0.30-2.00

*Please refer to page A087 for other steel.

OPTIMUM GRADES AND CHIPBREAKERS FOR EXTERNAL TURNING

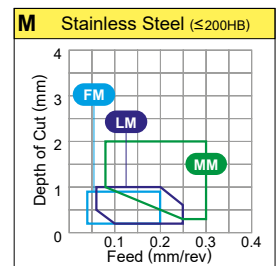
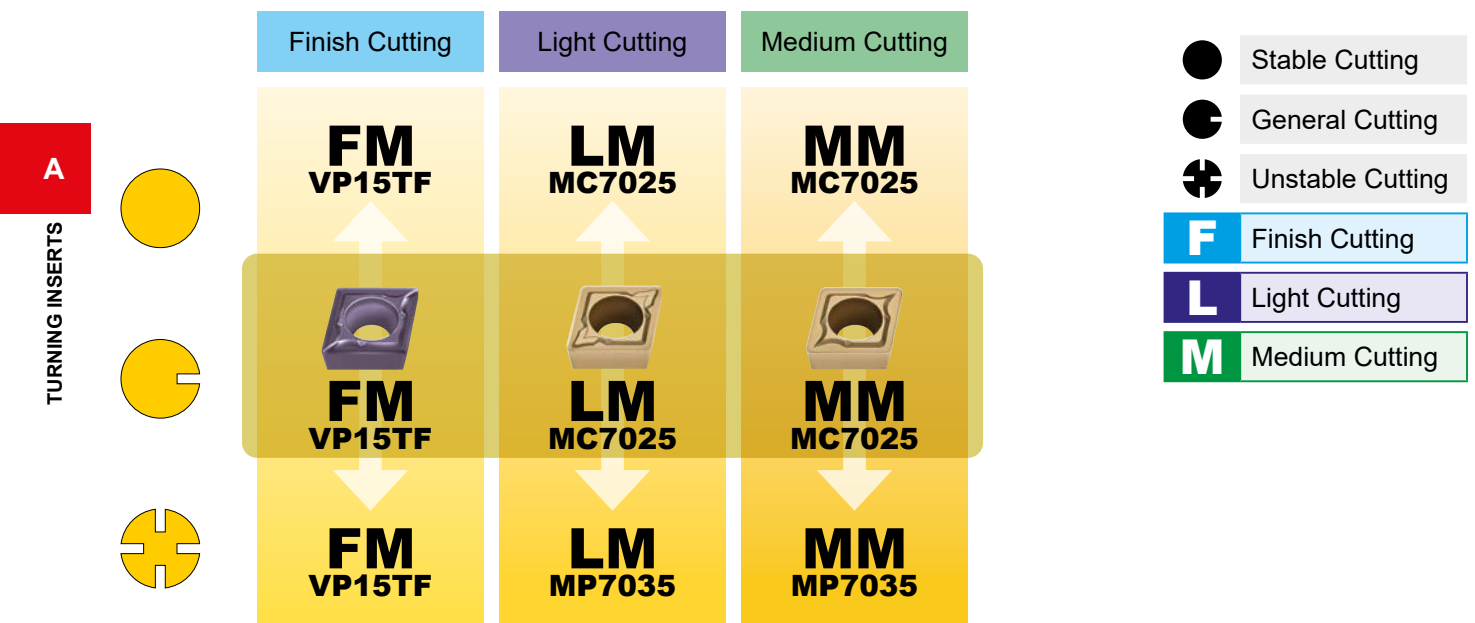

M Stainless Steel* (ex. X5CrNi189, X5CrNiMo1810) 7° POSITIVE INSERTS WITH HOLE

V_c : Cutting Speed
f : Feed
ap : Depth of Cut

	Cutting Area	Chipbreaker	Grade	1st Recommendation		
				V _c (m/min)	f (mm/rev)	ap (mm)
Stable Cutting	F	FM	VP15TF	75-125	0.04-0.20	0.20-0.90
	L	LM	MC7025	140-190	0.06-0.25	0.20-1.00
	M	MM	MC7025	120-160	0.08-0.30	0.30-2.00
General Cutting	F	FM	VP15TF	75-125	0.04-0.20	0.20-0.90
	L	LM	MC7025	140-190	0.06-0.25	0.20-1.00
	M	MM	MC7025	120-160	0.08-0.30	0.30-2.00
Unstable Cutting	F	FM	VP15TF	75-125	0.04-0.20	0.20-0.90
	L	LM	MP7035	85-135	0.06-0.25	0.20-1.00
	M	MM	MP7035	70-115	0.08-0.30	0.30-2.00

*Please refer to page A089 for other stainless steel.

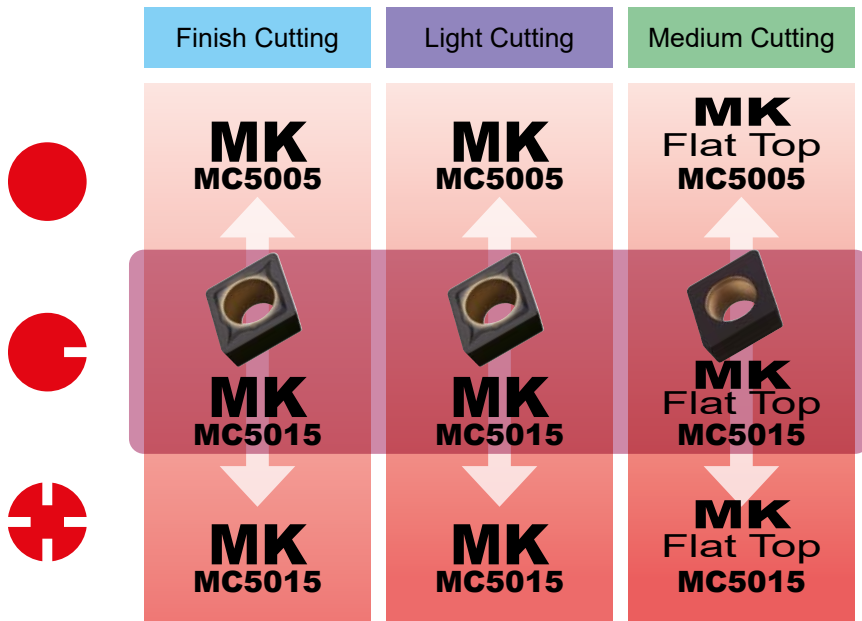

- Stable Cutting
- General Cutting
- Unstable Cutting
- F** Finish Cutting
- L** Light Cutting
- M** Medium Cutting

A
TURNING INSERTS

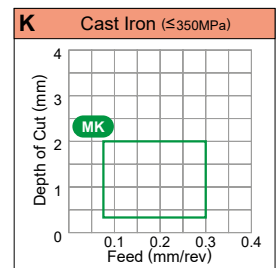

K Cast Iron* (ex. GG30)
7° POSITIVE INSERTS WITH HOLE

Vc : Cutting Speed
f : Feed
ap : Depth of Cut

	Cutting Area	Chipbreaker	Grade	1st Recommendation		
				Vc (m/min)	f (mm/rev)	ap (mm)
	F	MK	MC5005	165-265	0.08-0.30	0.30-2.00
	L	MK	MC5005	165-265	0.08-0.30	0.30-2.00
	M	MK, Flat Top	MC5005	165-265	0.08-0.30	0.30-2.00
	F	MK	MC5015	150-240	0.08-0.30	0.30-2.00
	L	MK	MC5015	150-240	0.08-0.30	0.30-2.00
	M	MK, Flat Top	MC5015	150-240	0.08-0.30	0.30-2.00
	F	MK	MC5015	150-240	0.08-0.30	0.30-2.00
	L	MK	MC5015	150-240	0.08-0.30	0.30-2.00
	M	MK, Flat Top	MC5015	150-240	0.08-0.30	0.30-2.00

*Please refer to page A092 for other types of cast iron.

OPTIMUM GRADES AND CHIPBREAKERS FOR EXTERNAL TURNING

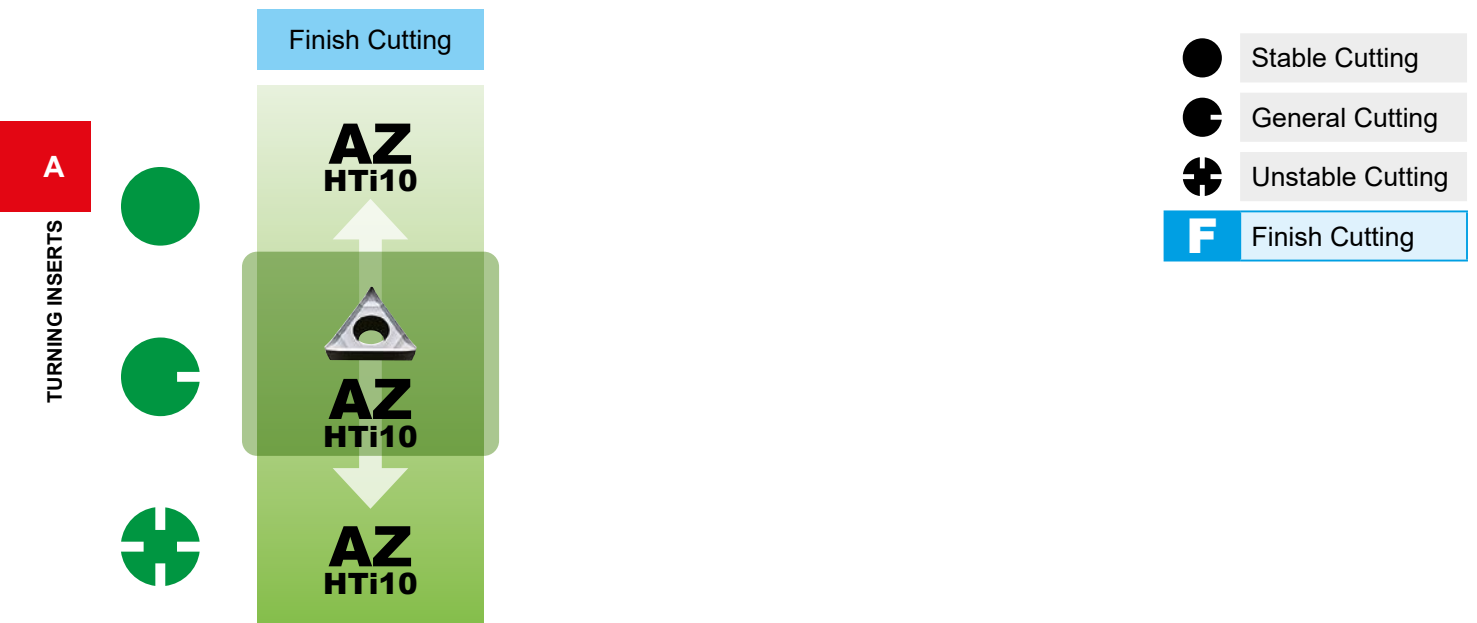

N Aluminium Alloy* (ex. A6061, A7075)
7° POSITIVE INSERTS WITH HOLE

Vc : Cutting Speed
f : Feed
ap : Depth of Cut

	Cutting Area	Chipbreaker	Grade	1st Recommendation		
				Vc (m/min)	f (mm/rev)	ap (mm)
● Stable Cutting	F	AZ	HTi10	300—700	0.10—0.40	0.20—3.00
● General Cutting	F	AZ	HTi10	300—700	0.10—0.40	0.20—3.00
⊕ Unstable Cutting	F	AZ	HTi10	300—700	0.10—0.40	0.20—3.00

*Please refer to page A093 for other aluminium alloys.

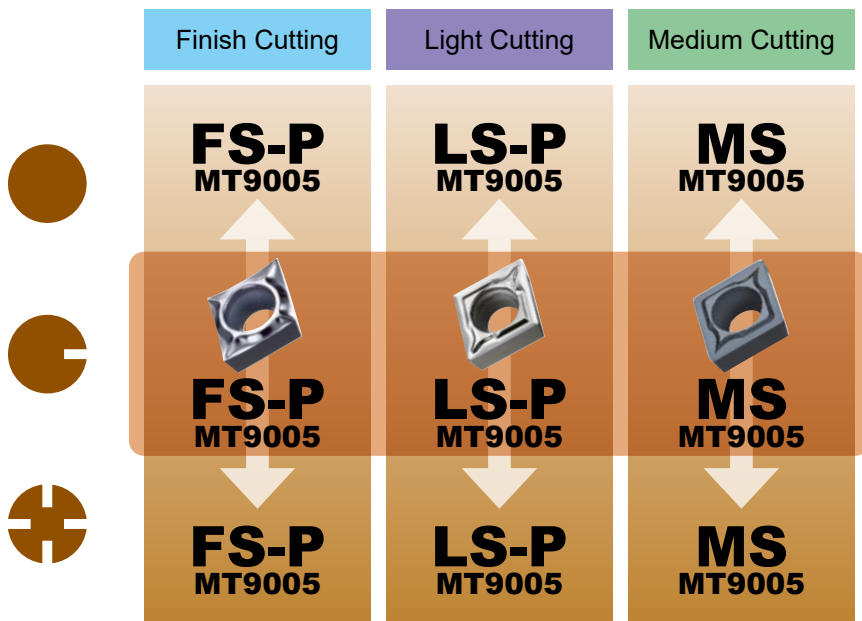

- Stable Cutting
- General Cutting
- Unstable Cutting
- F** Finish Cutting
- L** Light Cutting
- M** Medium Cutting

A
TURNING INSERTS

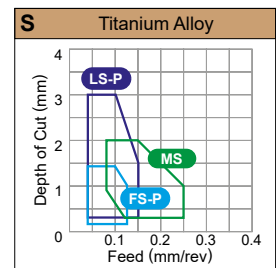

S Titanium Alloy (ex. Ti-6Al-4V)
7° POSITIVE INSERTS WITH HOLE

Vc : Cutting Speed
f : Feed
ap : Depth of Cut

	Cutting Area	Chipbreaker	Grade	1st Recommendation		
				Vc (m/min)	f (mm/rev)	ap (mm)
Stable Cutting	F	FS-P	MT9005	40-80	0.04-0.12	0.20-1.40
	L	LS-P	MT9005	40-80	0.04-0.15	0.30-3.00
	M	MS	MT9005	35-65	0.08-0.25	0.30-2.00
General Cutting	F	FS-P	MT9005	40-80	0.04-0.12	0.20-1.40
	L	LS-P	MT9005	40-80	0.04-0.15	0.30-3.00
	M	MS	MT9005	35-65	0.08-0.25	0.30-2.00
Unstable Cutting	F	FS-P	MT9005	40-80	0.04-0.12	0.20-1.40
	L	LS-P	MT9005	40-80	0.04-0.15	0.30-3.00
	M	MS	MT9005	35-65	0.08-0.25	0.30-2.00

OPTIMUM GRADES AND CHIPBREAKERS FOR EXTERNAL TURNING

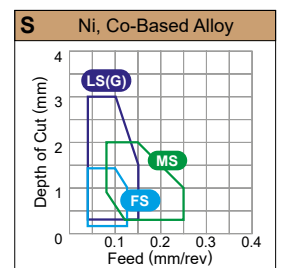
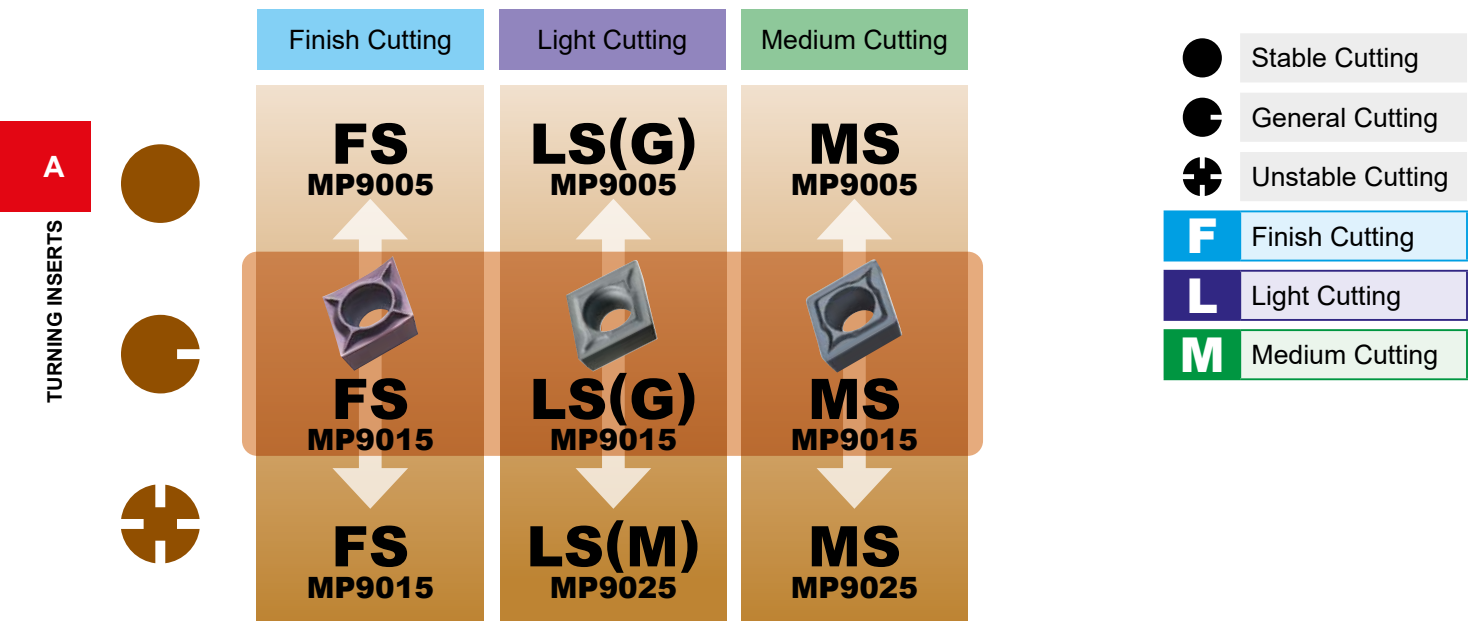

S Ni, Co-Based Alloy* (ex. Inconel718)
7° POSITIVE INSERTS WITH HOLE

Vc : Cutting Speed
f : Feed
ap : Depth of Cut

	Cutting Area	Chipbreaker	Grade	1st Recommendation		
				Vc (m/min)	f (mm/rev)	ap (mm)
● Stable Cutting	F	FS	MP9005	25-95	0.04-0.12	0.20-1.40
	L	LS(G)	MP9005	25-95	0.04-0.15	0.30-3.00
	M	MS	MP9005	20-80	0.08-0.25	0.30-2.00
◐ General Cutting	F	FS	MP9015	20-75	0.04-0.12	0.20-1.40
	L	LS(G)	MP9015	20-75	0.04-0.15	0.30-3.00
	M	MS	MP9015	20-60	0.08-0.25	0.30-2.00
⊕ Unstable Cutting	F	FS	MP9015	20-75	0.04-0.12	0.20-1.40
	L	LS(M)	MP9025	15-25	0.06-0.20	0.20-1.00
	M	MS	MP9025	15-20	0.08-0.25	0.30-2.00

* G class is recommended for the above FS/LS breaker

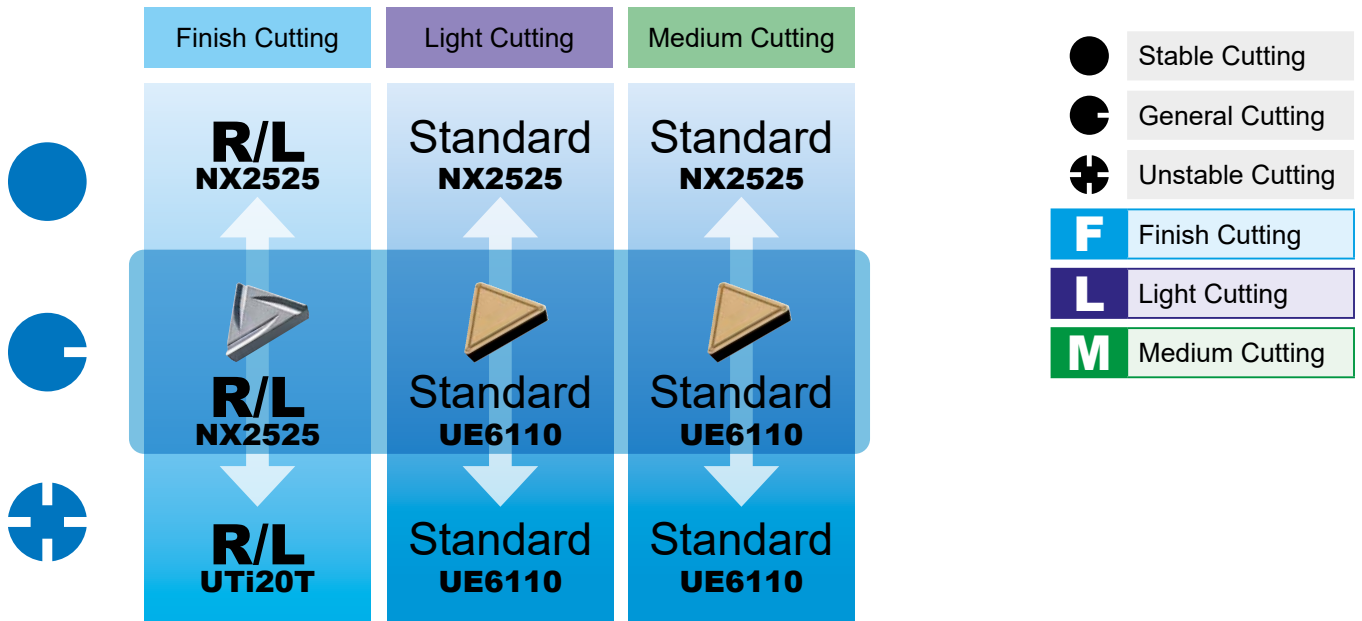

TURNING INSERTS
A

P Mild Steel (ex. St37-2, Ck10)
11° POSITIVE INSERTS WITHOUT HOLE

Vc : Cutting Speed
f : Feed
ap : Depth of Cut

	Cutting Area	Chipbreaker	Grade	1st Recommendation		
				Vc (m/min)	f (mm/rev)	ap (mm)
Stable Cutting	F	R/L	NX2525	225—320	0.05—0.12	0.20—0.60
	L	Standard	NX2525	185—270	0.08—0.30	0.30—2.00
	M	Standard	NX2525	185—270	0.08—0.30	0.30—2.00
General Cutting	F	R/L	NX2525	225—320	0.05—0.12	0.20—0.60
	L	Standard	UE6110	210—355	0.08—0.30	0.30—2.00
	M	Standard	UE6110	210—355	0.08—0.30	0.30—2.00
Unstable Cutting	F	R/L	UTi20T	115—165	0.05—0.12	0.20—0.60
	L	Standard	UE6110	210—355	0.08—0.30	0.30—2.00
	M	Standard	UE6110	210—355	0.08—0.30	0.30—2.00

OPTIMUM GRADES AND CHIPBREAKERS FOR EXTERNAL TURNING

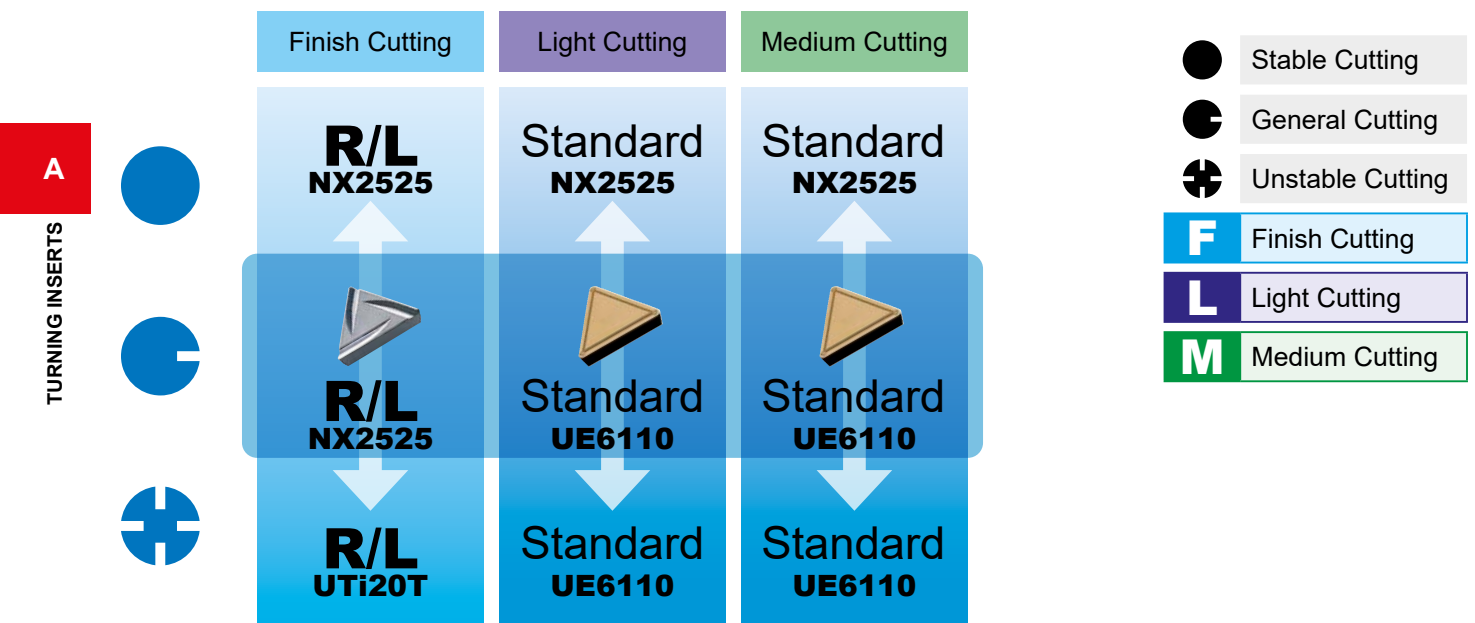

P Carbon Steel • Alloy Steel (ex. Ck45, 42CrMo4)
11° POSITIVE INSERTS WITHOUT HOLE

V_c : Cutting Speed
f : Feed
a_p : Depth of Cut

	Cutting Area	Chipbreaker	Grade	1st Recommendation		
				V _c (m/min)	f (mm/rev)	a _p (mm)
Stable Cutting	F	R/L	NX2525	165—240	0.05—0.12	0.20—0.60
	L	Standard	NX2525	140—200	0.08—0.30	0.30—2.00
	M	Standard	NX2525	140—200	0.08—0.30	0.30—2.00
General Cutting	F	R/L	NX2525	165—240	0.05—0.12	0.20—0.60
	L	Standard	UE6110	155—260	0.08—0.30	0.30—2.00
	M	Standard	UE6110	155—260	0.08—0.30	0.30—2.00
Unstable Cutting	F	R/L	UTi20T	85—120	0.05—0.12	0.20—0.60
	L	Standard	UE6110	155—260	0.08—0.30	0.30—2.00
	M	Standard	UE6110	155—260	0.08—0.30	0.30—2.00

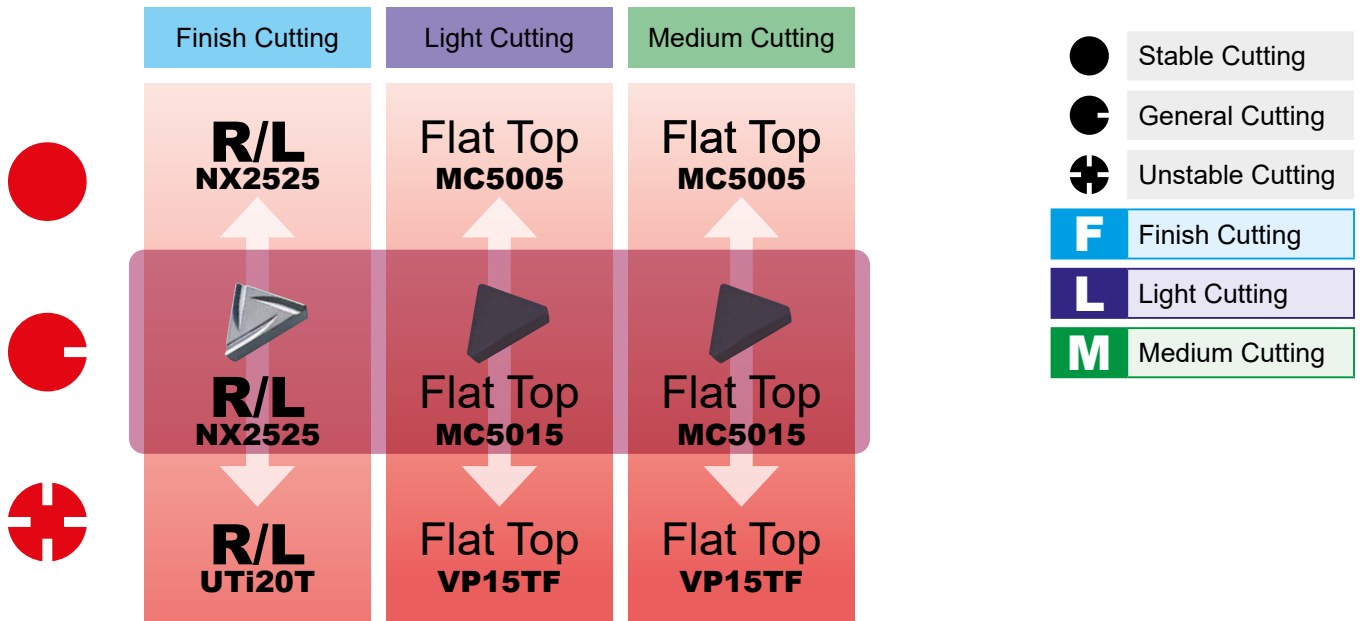

K Cast Iron* (ex. GG30)
 11° POSITIVE INSERTS WITHOUT HOLE

Vc : Cutting Speed
 f : Feed
 ap : Depth of Cut

	Cutting Area	Chipbreaker	Grade	1st Recommendation		
				Vc (m/min)	f (mm/rev)	ap (mm)
Stable Cutting	F	R/L	NX2525	145—200	0.05—0.12	0.20—0.60
	L	Flat Top	MC5005	165—265	0.08—0.30	0.30—2.00
	M	Flat Top	MC5005	165—265	0.08—0.30	0.30—2.00
General Cutting	F	R/L	NX2525	145—200	0.05—0.12	0.20—0.60
	L	Flat Top	MC5015	150—240	0.08—0.30	0.30—2.00
	M	Flat Top	MC5015	150—240	0.08—0.30	0.30—2.00
Unstable Cutting	F	R/L	UTi20T	80—115	0.05—0.12	0.20—0.60
	L	Flat Top	VP15TF	115—160	0.08—0.30	0.30—2.00
	M	Flat Top	VP15TF	115—160	0.08—0.30	0.30—2.00

*Please refer to page A096 for other types of cast iron.





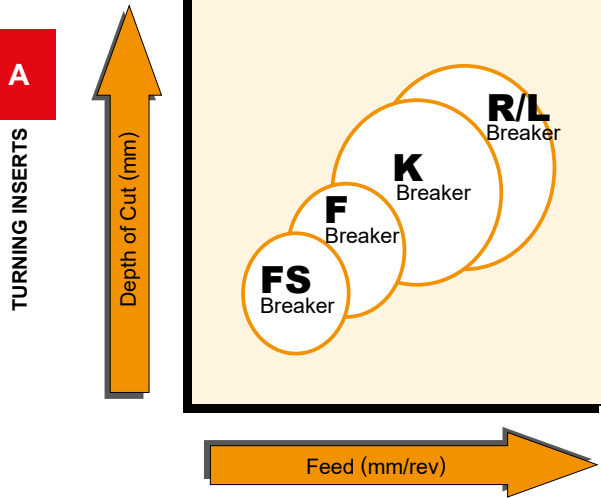

PRECISION BREAKER SYSTEM

ANGULAR AND PARALLEL CHIPBREAKERS (NEGATIVE INSERTS)

CHIP CONTROL RANGE

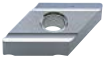

FEATURES OF CHIPBREAKER

Breaker	Features	DNGG Type	SNGG Type	TNGG Type	VNGG Type
FS	<ul style="list-style-type: none"> ● For precision finishing. ● Small width lead breaker for good chip control. ● Sharp cutting edge gives a good surface finish. 	—	—		—
F	<ul style="list-style-type: none"> ● For finish cutting. ● Lead breaker controls chip flow. ● Sharp cutting edge gives a good surface finish. 	—	—		—
K	<ul style="list-style-type: none"> ● Parallel breaker for light cutting. ● Excellent chip control for low to medium feed rates. 	—	—		—
R/L	<ul style="list-style-type: none"> ● Parallel breaker for medium cutting. ● Good chip control for medium feed rates. 				

ANGULAR AND PARALLEL CHIPBREAKER

■ For turning small, high precision parts

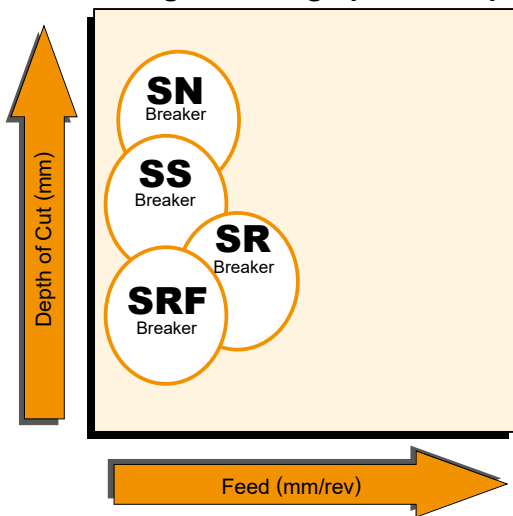

■ For general turning

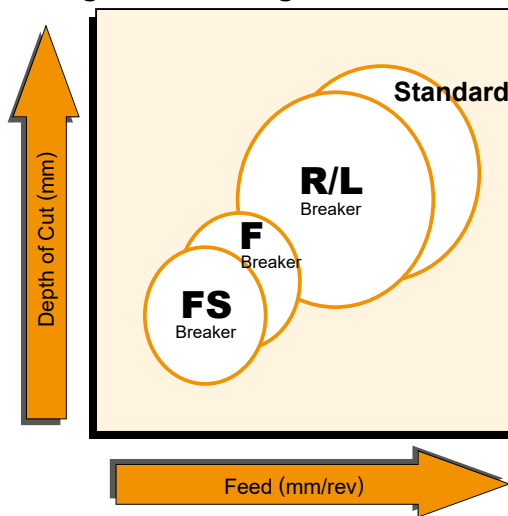

FEATURES OF CHIPBREAKER

Breaker	Features	CCET Type	CCGT Type	DCET Type	DCGT Type	VBET Type
SRF	<ul style="list-style-type: none"> The wide lead breaker for medium cutting is suitable for automatic lathe machining. The insert designed for low resistance controls chip flow. 	—	—	—		
SR	<ul style="list-style-type: none"> The wide lead breaker for medium cutting is suitable for automatic lathe machining. The insert designed for low resistance controls chip flow. 		—		—	
SS	<ul style="list-style-type: none"> The parallel breaker for light cutting is suitable for automatic lathe machining. Excellent chip control at low feed rates. 	—		—		—
SN	<ul style="list-style-type: none"> The parallel breaker for general purpose is suitable for automatic lathe machining. Excellent chip control for low to medium feed rates. 					

Breaker	Features	CCGH/CCGT Type	CPGT Type	DCGT Type	TPGH Type	TCGT Type	VBGT/VCGT Type	WBG Type	WCGT Type	WPGT Type
FS	<ul style="list-style-type: none"> For precision finishing. Small width lead breaker for excellent chip control. Sharp cutting edge gives a good surface finish. 	—	—	—		—	—	—	—	
F	<ul style="list-style-type: none"> For finish cutting. Lead breaker controls chip flow. Sharp cutting edge gives a good surface finish. 				—				—	—
R/L	<ul style="list-style-type: none"> Lead breaker for light cutting. Good chip control for low to medium feed rates. 	—	—	—	—	—	—	—		—
Standard	<ul style="list-style-type: none"> For light cutting. Good chip control for low to medium feed rates. 	—		—	—	—	—	—	—	—

WIPER INSERT

What is a Wiper Insert?

- The wiper insert is designed with a wiper edge that is situated where the straight edge meets the corner radius.
- In comparison to conventional breakers, the surface finish does not deteriorate even if the feed rate is doubled.
- Machining at high feed rates improves cutting efficiency.

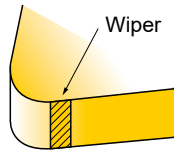

● Improving Surface Finish

Under the same machining conditions as conventional breakers, but with the feed rate increased, the surface finish of the workpiece can be improved.

● Improving Efficiency

High feed rates not only shorten machining times but also make it possible to combine roughing and finishing operations.

● Increased Tool Life

When using to high feed conditions, the time required to cut one component is decreased, thus more parts can be machined with each insert. In addition, the high feed rate prevents rubbing, therefore, delaying the progression of wear and increasing the tool life of the insert.

● Improving Chip Control

Under high feed conditions, the chips generated become thicker and are more easily broken, thus, chip control is improved.

TURNING INSERTS

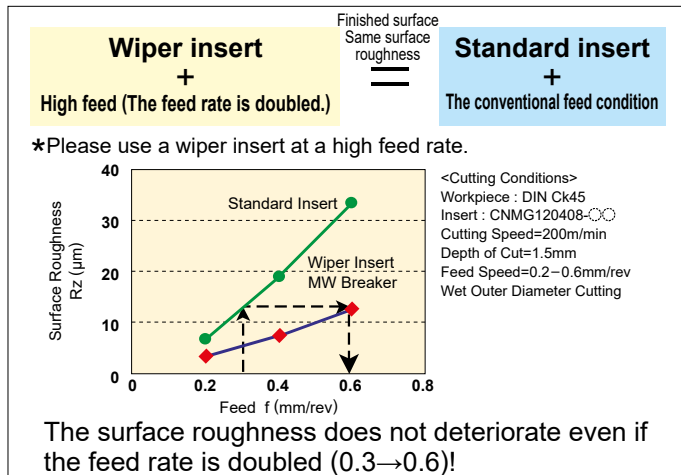

■ A wiper insert + machining at high feed rate

- Reduced machining time (per workpieces)
- Increased number of workpieces (per definitive time period)
- Improving chip control

■ A wiper insert + machining at conventional feed rate

- Eliminating the finishing step by roughing and finishing together (Separate roughing and finishing steps → Single-step machining)

- Reducing cycle times
- Increased productivity
- Avoiding Line-Stoppage

The realisation of Reduced Costs!!

■ Estimating the finished surface roughness when using a wiper insert

The effects of wiper inserts on external machining, boring and facing.

★The surface roughness when machining at a corner R or taper angle over 5°, is the same as machining with standard inserts.

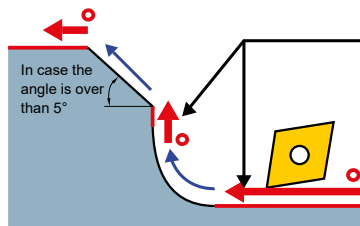

$$Rz(W) = Rz \times 0.5$$

$Rz(W)$ = Finished surface roughness when using a wiper insert.
 Rz : Finished surface roughness from conventional conditions. (When using a standard insert)

- Effective usage of a wiper insert
- Non effective usage of a wiper insert

■ Special attention is not necessary when using CNMG • WNMG • CCMT types

● No Restriction for Holders

A standard holder can be used. (★A double clamp, high rigidity tool is recommended.)

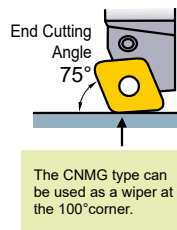
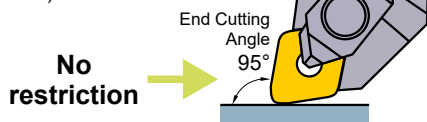

● Not Necessary to Adjust the Machining Programme

Conventional machining programmes can be used. (The CNMG • WNMG • CCMT types are based on the ISO/ANSI.)

Not necessary to adjust

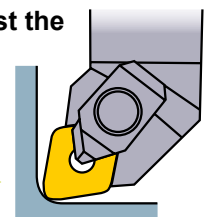

■ Special attention is necessary when using the DNMX • TNMX types due to the special top face geometry

● Restriction for Holders

Use a holder with an end cutting angle of 93° for improving wiper efficiency. A holder with an end cutting angle of 91° can improve wiper efficiency (see the following figure), however, there is no wiper efficiency with other end cutting angles (60°, 90°, 107° etc.).

The hole geometry of the DNMX and TNMX type are the same as the DNMG and TNMG types. The "X" represents the special geometry of the corner point.

93° (Specified)

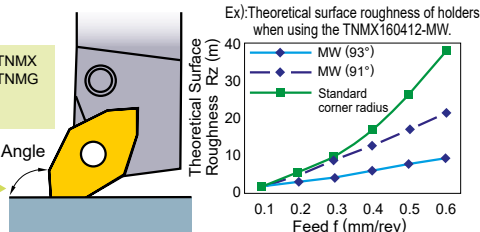

● Necessary to Adjust the Machining Programme

When machining errors occur, please adjust the programme. (The DNMX-TNMX types are not based on the ISO/ANSI. Please refer to the next page.)

Adjustment necessary

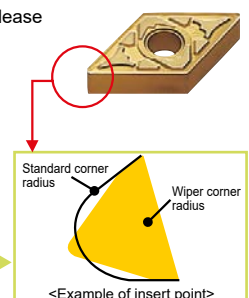

■ Adjustment of machining programmes for DNMX • TNMX types

Basic Process) Adjusting Toward X-axis and Z-axis
Adjusting the differential between a standard insert and Z-axis / X-axis.

Adjustment toward X-axis

Standard insert DNMX, TNMX type

Corner radius 0.4, 0.8: **0.04 mm**
Corner radius 1.2 : **0.05 mm**

Adjustment toward Z-axis

Standard insert DNMX, TNMX type

(Not closed to Corner R) **0.01mm**

A) Adjusting a Taper *Necessary to maintain a correct taper.

Adjust the relief angle toward the normal line.

Note 1) Adjust the angle toward the normal line in the case where the adjustment number is minus ($\theta = 60^\circ - 70^\circ$) and is not machined completely.

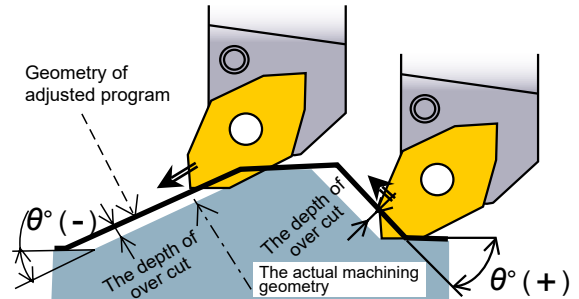

Classification

Corner radius	Taper Angle θ°															
	-25--15	-10	-5	0	5	10	15	20-35	40	45	50	55	60-65	70	75-85	90
1.2	0.04	0.03	0.01	0	0.02	0.03	0.04	0.05	0.04	0.04	0.02	0.01	-0.01	0	0.01	0
0.8	0.03	0.02	0.01	0	0.01	0.02	0.03	0.04	0.03	0.03	0.02	0	-0.01	0	0.01	0
0.4	0.02	0.01	0.01	0	0.01	0.01	0.02	0.02	0.02	0.01	0.01	0	-0.01	-0.01	0	0

The number \rightarrow +numbers: adjustment of relief angle, -numbers: adjustment of drive-in angle (mm)

B) Adjusting a Corner R *Necessary to maintain a correct corner radius.

Adjust the work diameter to the same as the taper to prevent over-cut.

The value of adjustment to workpiece R = Workpiece R + the adjustment value
*No adjustment of the corner radius in this case.

Ex : In case of machining R 2.0 when using a corner R 1.2 type insert.

The corner radius of the insert	The adjustment amount on the workpiece radius.
Corner Radius 0.4 \rightarrow	Work Radius + 0.05(mm)
Corner Radius 0.8 \rightarrow	Work Radius + 0.11(mm)
Corner Radius 1.2 \rightarrow	Work Radius + 0.14(mm)

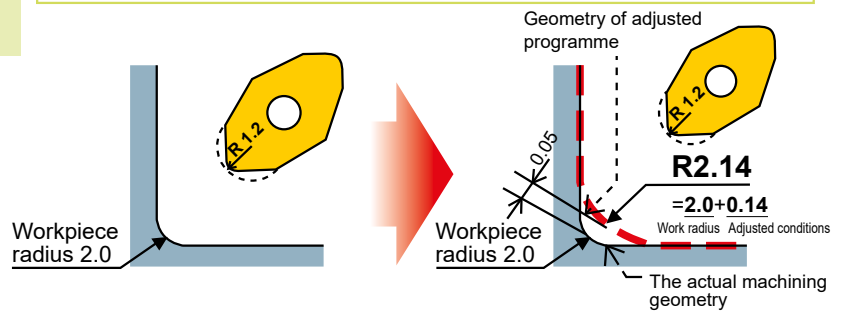

When correcting corner radius:

It is not necessary to adjust the machining programme, however, machining errors can occur within max. $\pm 0.03\text{mm}$ due to corrections by an approximate number.

The Easy-to-correct Method

Corner Radius Correction Input the correction number of each corner radius.

The value of corrected corner radius = approximation
*No need to adjust the programme in this case.

Ex : In the case of machining a corner with a radius R 2.0 when using an insert with a corner radius R 1.2.

The corner radius of the insert	The value of corrected corner radius = approximation
Corner Radius 0.4 \rightarrow	R0.36(mm)
Corner Radius 0.8 \rightarrow	R0.76(mm)
Corner Radius 1.2 \rightarrow	R1.16(mm)

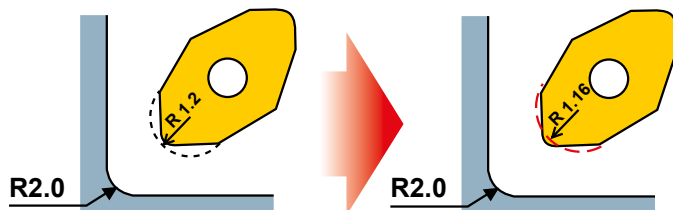

Others : The value of correction is same for both DNMX and TNMX. Differentiate between them by the size of corner radius.

GRADES FOR TURNING

● INDEXABLE INSERT GRADES FOR TURNING

TURNING INSERTS

A

ISO	Coated Carbide		Cermets	Coated Cermet	Cemented Carbide	Coated PCBN	PCBN	PCD (Sintered Diamond)
	CVD	PVD						
Steel P	10	MC6115 ^{NEW} , UE6105, MC6015, MY5015						
	20	MC6125 ^{NEW} , MC6025, VP10RT, VP10MF, MS6015	NX2525, NX3035	AP25N, VP25N				
	30	MC6035, UH6400, VP15TF, VP20MF, VP20RT, UP20M		MP3025, VP45N	UTi20T			
	40							
Stainless Steel M	10	MC7015, US7020		AP25N, VP25N				
	20	MC7025, VP10RT, VP10MF, MS9025 ^{NEW}	NX2525					
	30	MC7025, VP15TF, VP20MF, VP20RT, UP20M						
	40	US735, MP7035			UTi20T			
Cast Iron K	10	MC5005, MC5015, MY5015, MH515 ^{NEW}		AP25N, VP25N	HTi05T			
	20	VP10RT, VP15TF, VP20RT	NX2525		HTi10	BC5110 ^{NEW}	MB710	
	30				UTi20T		MB730, MB4120, MBS140	
	40							
Non-Ferrous Metal Z	10							
	20				HTi10			MD220
	30							MD2030
	40							
Heat Resistant Alloy • Ti Alloy G	10	US905			MT9005, RT9005		MB730	
	20	MP9005, VP05RT, MP9015, VP10RT			MT9015, RT9010			
	30	MP9025 ^{NEW} , VP20RT, MS9025 ^{NEW}						
	40							
Hardened Steel H	10					BC8105, BC8110, BC8210 ^{NEW} , BC8120, BC8220 ^{NEW} , BC8130	MB8110 ^{NEW} , MB8120 ^{NEW} , MB8130 ^{NEW}	
	20							
	30							
	40							

TURNING APPLICATION RANGE

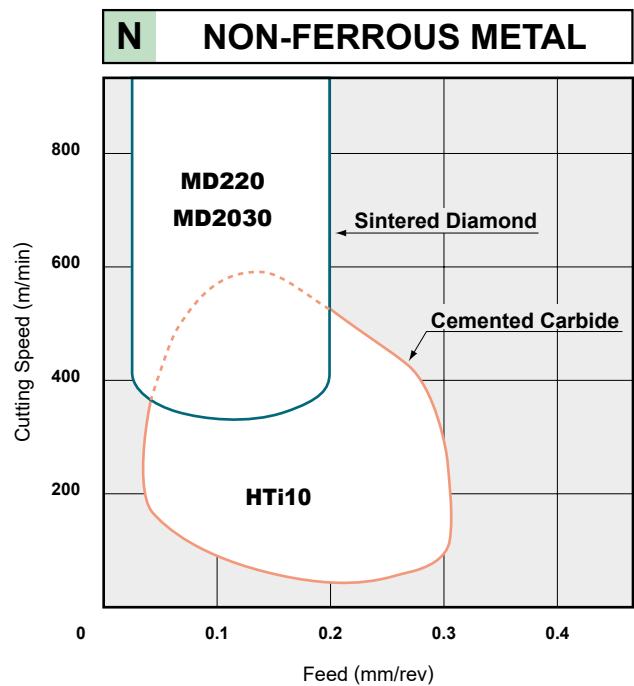
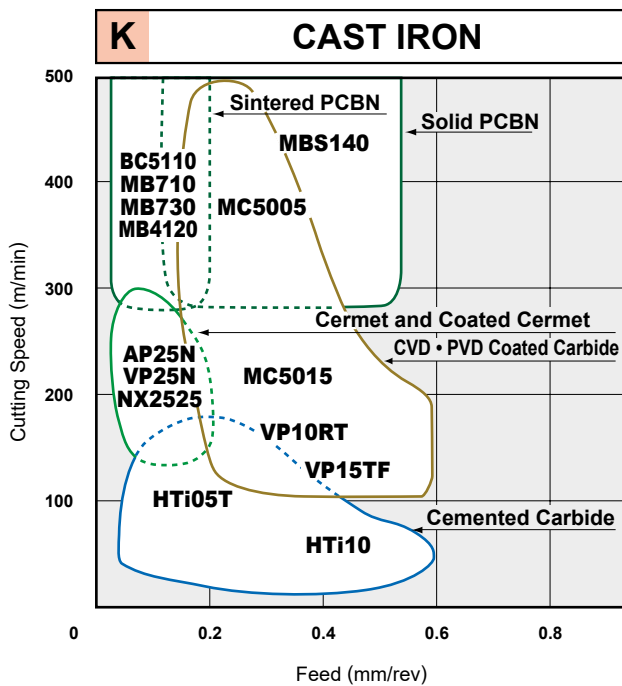
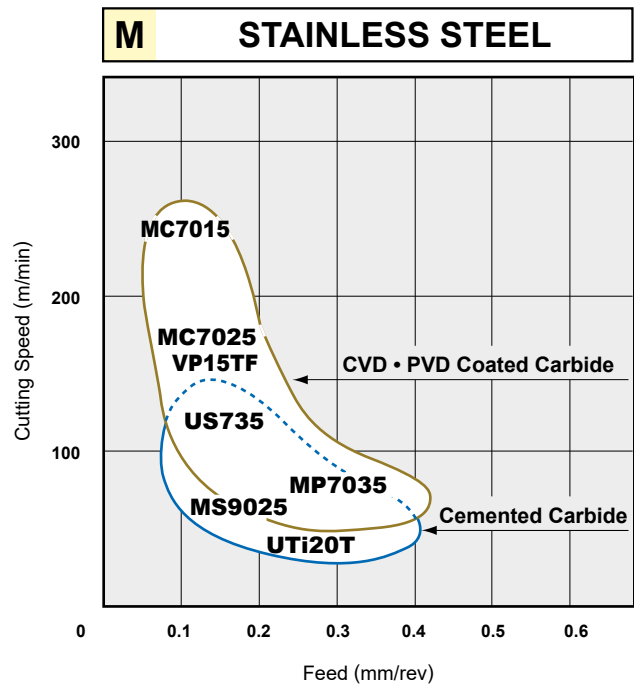
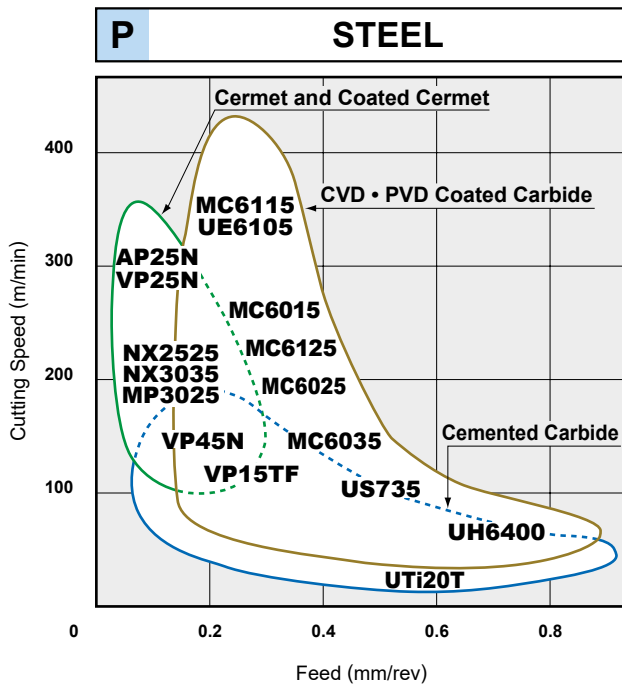

TURNING APPLICATION RANGE

● Recommended insert grade based on cutting speed and conditions for each workpiece material.

A

TURNING INSERTS

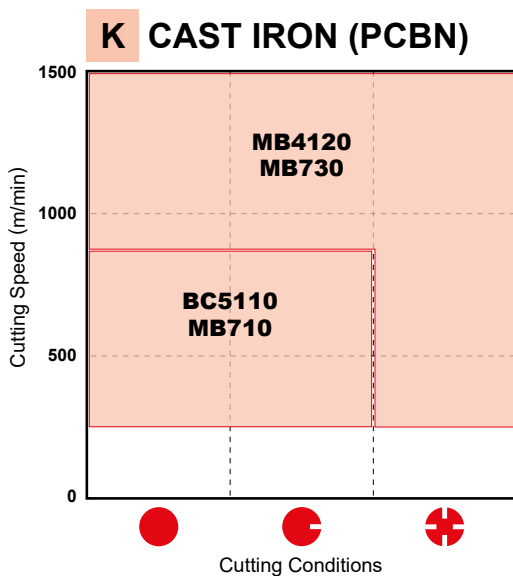
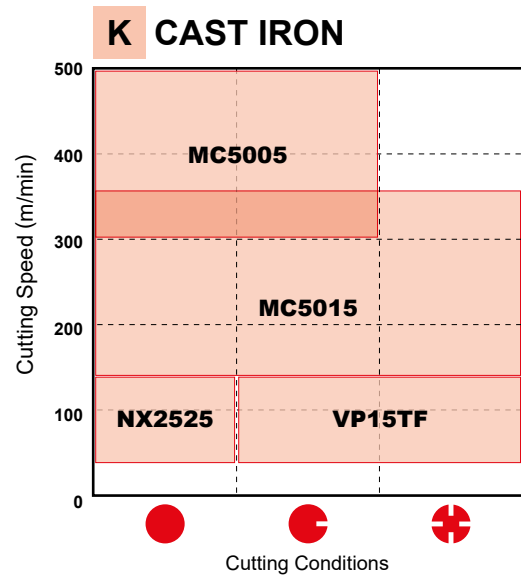
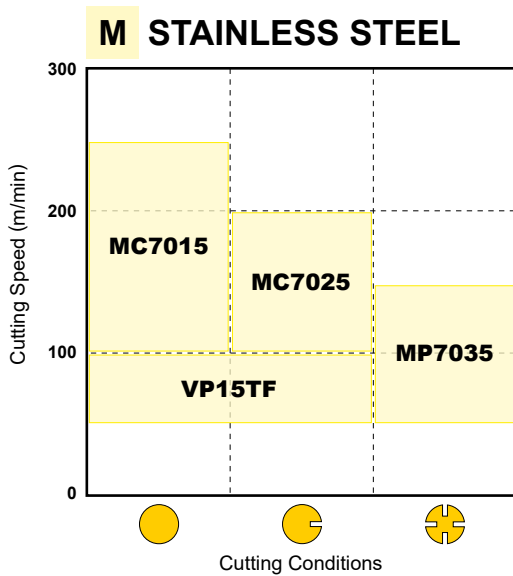
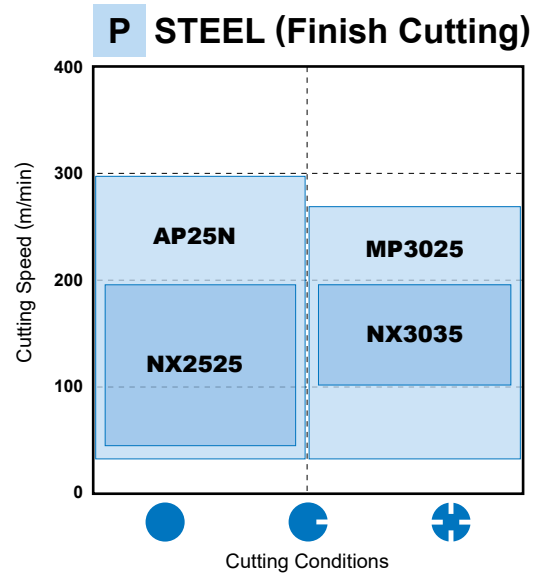
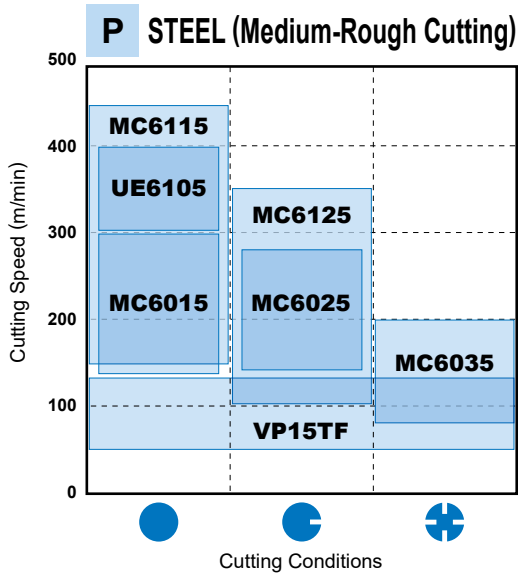

CUTTING CONDITIONS

- Stable Cutting**
 Continuous Cutting
 Constant Depth of Cut
 Pre-Machined
 Securely Clamped Component Cutting
- General Cutting**
- Unstable Cutting**
 Heavy Interrupted Cutting
 Irregular Depth of Cut
 Low Clamping Rigidity Cutting

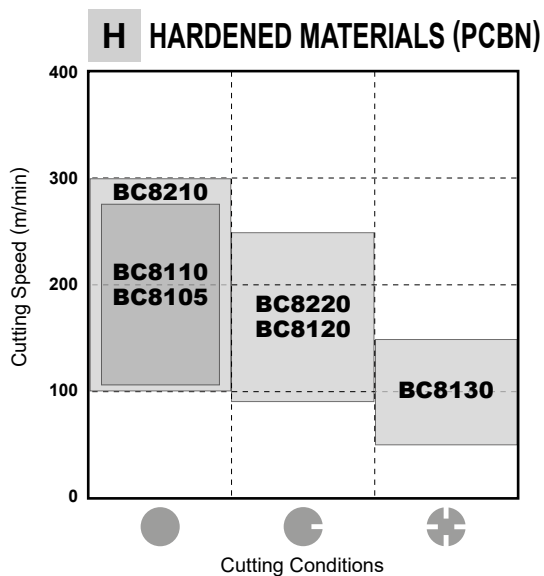
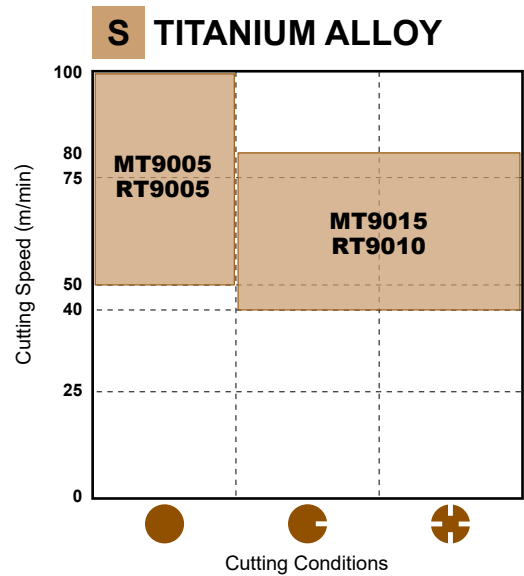
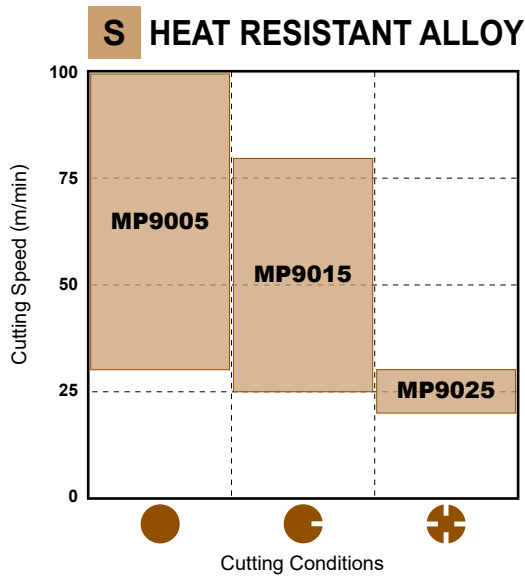
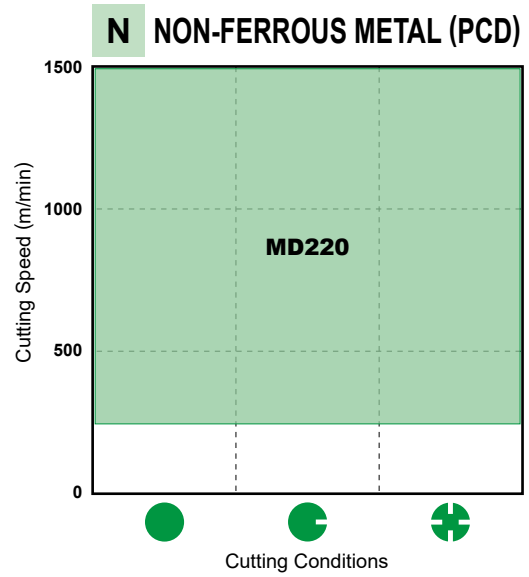
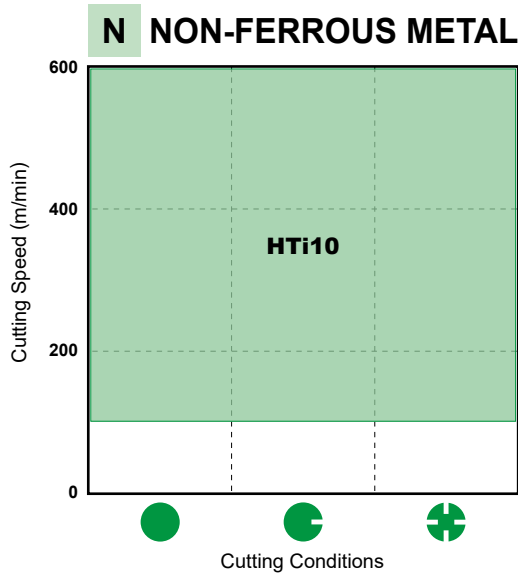

A

TURNING INSERTS

COATED CARBIDE (CVD)

- Special tough fibrous structure improves wear and fracture resistance.
- Covers a wide application range and thus reduces the number of tools required.

SELECTION STANDARD

TURNING

TURNING INSERTS

Work Material	Cutting Mode	Recommended Grade	Recommended Cutting Speed (m/min)	ISO	Application Range
Steel	Continuous Cutting	UE6105	300 (200 – 400)	P	
		MC6115	300 (150 – 450)		
	Interrupted Cutting	MC6125	200 (100 – 350)		
		MC6035	150 (80 – 200)		
Stainless Steel	Continuous Cutting	MC7015	200 (160 – 250)	M	
		MC7025	150 (120 – 200)		
	Continuous and Interrupted Cutting	US735	100 (80 – 120)		
Cast Iron Ductile Cast Iron	Continuous Cutting	MC5005	300 (200 – 400)	K	
	Interrupted Cutting	MC5015	250 (150 – 300)		
Heat Resistant Alloy	Continuous and Interrupted Cutting	US905	80 (50 – 100)	S 5	

Dramatic increase in stability and wear resistance, enabled by utilising the improved coating adhesion and crystal orientation technology.

MC6115

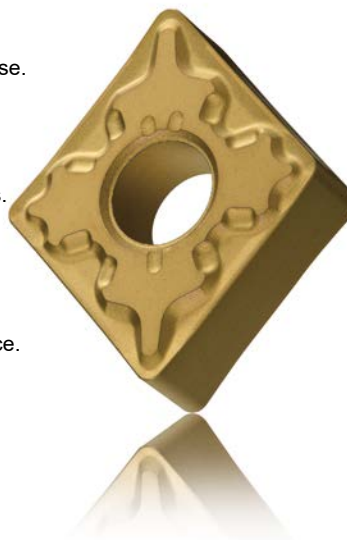
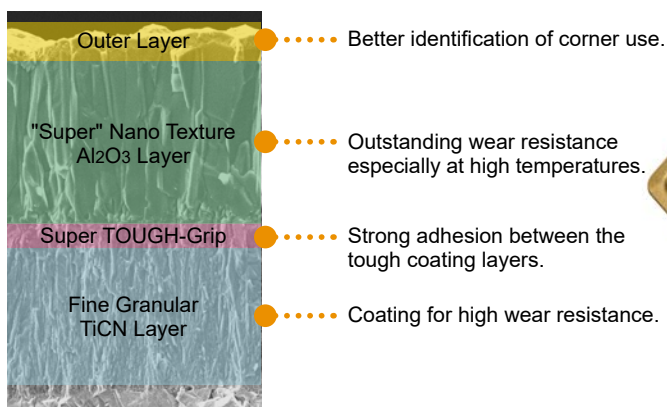

Super Nano Texture Technology

The standard Nano Texture Technology has been improved and developed to be an industry leading standard for crystal growth of Al₂O₃ coatings. This Super Nano Texture Technology increases tool life and wear resistance due to the fine, dense crystal growth process.

Super TOUGH-Grip

The Super TOUGH-Grip layer has finer crystal grains that enhance the strength of the adhesion between the coating layers.

■ GRADE CHARACTERISTICS

Work Material	Grade	Substrate	Coating Layer	
		Hardness (HRA)	Composition	Thickness
P Steel	UE6105	90.8	Accumulated TiCN-Al ₂ O ₃ -TiN Compound	
	MC6115	90.8	Accumulated TiCN-Al ₂ O ₃ -TiN Compound	
	MC6015	90.2	Accumulated TiCN-Al ₂ O ₃ -TiN Compound	
	MC6125	90.0	Accumulated TiCN-Al ₂ O ₃ -TiN Compound	
	MC6025	90.2	Accumulated TiCN-Al ₂ O ₃ -TiN Compound	
	MC6035	89.5	Accumulated TiCN-Al ₂ O ₃ -TiN Compound	
	UH6400	89.5	Accumulated TiCN-Al ₂ O ₃ -TiN Compound	
M Stainless Steel	MC7015	90.7	TiCN-Al ₂ O ₃ -TiN	
	US7020	90.5	TiCN-Al ₂ O ₃ -TiN	
	MC7025	89.4	TiCN-Al ₂ O ₃ -TiN	
	US735	89.0	TiN Compound	
K Cast Iron Ductile Cast Iron Heat Resistant Cast Steel	MC5005	91.0	TiCN-Al ₂ O ₃	
	MC5015	91.0	TiCN-Al ₂ O ₃	
	MH515	91.0	TiCN-Al ₂ O ₃	
S Heat Resistant Alloy	US905	92.2	TiCN-Al ₂ O ₃ -TiN	

Note 1) Hardness shows representative value of the substrate.

Strengthened chipping resistance

Cracks that occur during unstable machining are prevented due to the relaxing of the tensile stress in the coating. MC6100 series has an 80% reduction in coating tensile stress compared to conventional CVD inserts.

MC6125

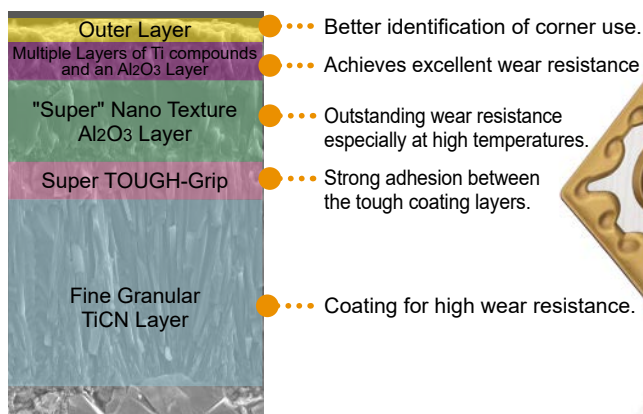

Impact Stress During Machining

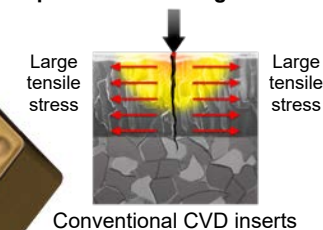

Cracks are generated in the surface of coatings during machining. They propagate through the coating into the substrate due to the large tensile stress in the coating structure. This creates one of the main causes of sudden insert breakage.

Impact Stress During Machining

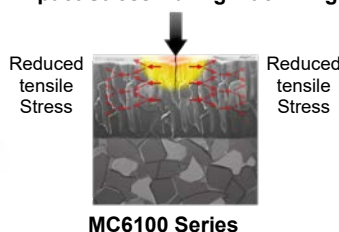

MC6100 series has a much lower level of stress than conventional CVD coatings due to the surface treatment. This divides the force of impacts during machining and protects from sudden fracturing.

Relaxing of the Tensile Stress

COATED CARBIDE (PVD)

- PVD coating prolongs tool life under the same cutting conditions compared to uncoated carbide.
- Coating of tools with sharp edges is possible without softening or changing the quality of the substrate.

SELECTION STANDARD

TURNING

TURNING INSERTS

Work Material	Recommended Grade	Recommended Cutting Speed (m/min)	ISO	Application Range
P Steel	VP10RT	120 (100 – 150)	P 10 20 30 40	
	VP15TF	120 (100 – 150)		
	UP20M	120 (100 – 150)		
M Stainless Steel	VP10RT	120 (100 – 150)	M 10 20 30 40	
	VP15TF	120 (100 – 150)		
	VP20MF	120 (100 – 150)		
	UP20M	120 (100 – 150)		
K Cast Iron	VP10RT	120 (100 – 150)	K 10 20 30	
	VP15TF	120 (100 – 150)		
	VP20RT	120 (100 – 150)		
S Heat Resistant Alloy	MP9005	60 (30 – 100)	S 10 20 30	
	MP9015	50 (25 – 80)		
	MP9025	25 (20 – 30)		

ISO Turning Inserts for Difficult to Cut Materials

NEW

MP9005/MP9015/MP9025

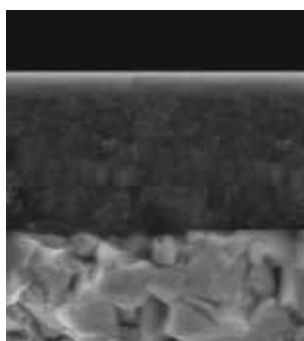

High Al-(Al,Ti)N single layer coating

Special carbide substrate

ISO Grade	Grade	Concept	Application
S01	MP9005	Top-quality grade focusing on wear resistance	Heat Resistant Alloy Finish-Medium Cutting
S10	MP9015	First recommendation for general applications	Heat Resistant Alloy Medium-Rough Cutting
S30	NEW MP9025	Prevents severe damage for increased stability.	Heat Resistant Alloy Interrupted • Light-Rough Cutting

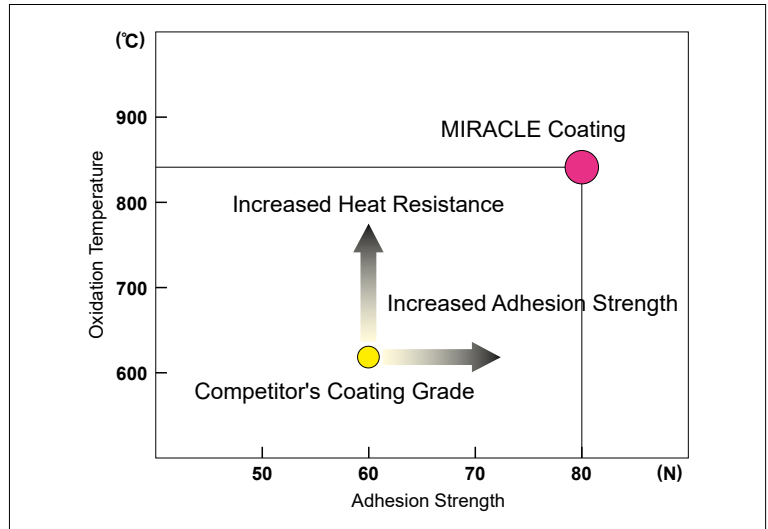

FEATURES OF VP (MIRACLE) COATING

Compared to conventional coating technology, VP (MIRACLE) coating features (Al,Ti)N coating with an increased heat resistance and adhesion strength.

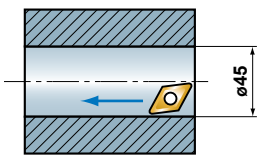
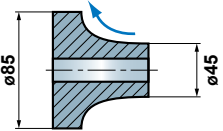
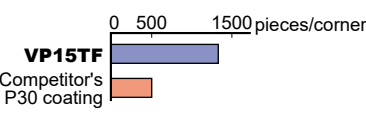
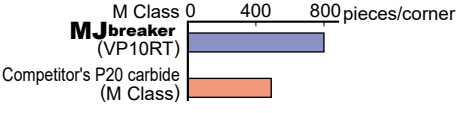

APPLICATION EXAMPLES

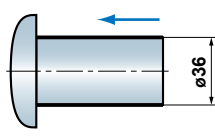
Insert (Grade)		DCMT11T304-MV(VP15TF)	CNMG120408-MJ(VP10RT)
Workpiece		Alloy steel 	Stainless Steel (Fan parts) 
Cutting Conditions	Cutting Speed (m/min)	170	200
	Feed (mm/rev)	0.14	0.25
	Depth of Cut (mm)	0.25	0.5
	Coolant	Wet cutting	Wet cutting
Result		 <p>The VP15TF type did not suffer from edge chipping. This enables stable machining and much longer tool life.</p>	 <p>MJ breaker achieved 1.5 times longer tool life.</p>

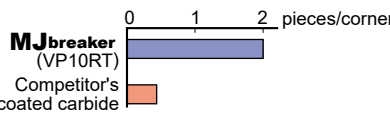
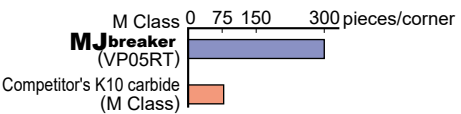
Insert (Grade)		CNMG120408-MJ(VP10RT)	TNMG160408-MJ(VP05RT)
Workpiece		Inconel 718 (Pin) 	Sintered iron parts (FH655) 
Cutting Conditions	Cutting Speed (m/min)	31	120
	Feed (mm/rev)	0.2	0.05
	Depth of Cut (mm)	2.3	0.5
	Coolant	Wet cutting	Wet cutting
Result		 <p>VP10RT achieved 4 times longer tool life. MJ breaker for excellent chip disposal and vastly increased tool life.</p>	 <p>MJ breaker achieved 5 times longer tool life.</p>

CERMET

- The optimized alloy structure and special alloy binder improves both wear and fracture resistance.
- It covers a wide application range and reduces the number of tools required.
- NX3035 for wet cutting.
- NX2525 for dry cutting.

A

TURNING INSERTS

SELECTION STANDARD

TURNING

Work Material	Cutting Mode	Recommended Grade	Recommended Cutting Speed (m/min)	ISO	Application Range
P Steel	Continuous Cutting	NX2525	220 (180 – 250)	P 10 20	
	Interrupted Cutting	NX3035	200 (190 – 260)		
K Cast Iron Ductile Cast Iron	Finishing	NX2525	180 (150 – 210)	K 10 20	

GRADE CHARACTERISTICS

Grade	Hardness (HRA)
NX2525	92.2
NX3035	91.5

Note 1) Hardness shows representative value of the substrate.

COATED CERMET

● Coated cermet (PVD coating) has superior wear and fracture resistance, and therefore provides a stable cutting performance.

SELECTION STANDARD

TURNING

Work Material	Cutting Mode	Recommended Grade	Recommended Cutting Speed (m/min)	ISO	Application Range
P Steel	Continuous Cutting	VP25N AP25N	240 (190 – 290)	P 10 20 30	
	Interrupted Cutting	MP3025	230 (180 – 280)		
K Cast Iron Ductile Cast Iron	Finishing	VP25N AP25N	160 (110 – 230)	K 10 20	

Effective for production of small parts.

MP3025

MP3025 provides improved adhesion of the coating layer due to the newly-developed special substrate. Uniform flank wear allows prolonged machining and maintains excellent surface finishes.

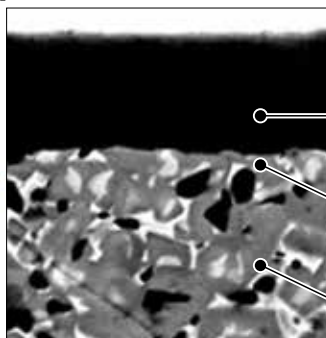

Ti-compound PVD coating provides excellent wear and welding resistance.

Substrate surface provides excellent adhesion strength for coating layer.

Substrate with superior fracture resistance and thermal shock resistance.

CEMENTED CARBIDE

● UTi grades are available for steel and cast iron. HTi grades are available for non-ferrous and non-metal materials and are also suitable for cast iron.

SELECTION STANDARD

TURNING

TURNING INSERTS

Work Material	Recommended Grade	Recommended Cutting Speed (m/min)	ISO	Application Range
P Steel	UTi20T	100 (60 – 130)	10	UTi20T
			20	
			30	
M Stainless Steel	UTi20T	100 (60 – 130)	10	UTi20T
			20	
			30	
K Cast Iron	HTi05T	120 (80 – 150)	10	HTi05T
	HTi10	100 (50 – 150)	20	HTi10
	UTi20T	100 (50 – 150)	30	UTi20T
N Non-Ferrous Metal	HTi10	300 (100 – 600)	10	HTi10
			20	
			30	
S Heat-resistant Alloy Ti Alloy	MT9005 RT9005	70 (50 – 100)	10	MT9005 RT9005
	MT9015 RT9015	60 (40 – 80)	20	MT9015 RT9015
			30	

MAIN COMPONENT AND APPLICATION

ISO	Main Component	Characteristics	Work Material
P M	WC-TiC-TaC-Co	Heat / deformation resistance.	Carbon steel, alloy steel, stainless steel and cast iron
K N	WC-Co	High rigidity and wear resistance.	Cast iron, non-ferrous metals, and non-metal
S	WC-Co	High heat resistance and wear resistance.	Heat-resistant alloy, Ti alloy

GRADE CHARACTERISTICS

ISO	Grade	Hardness (HRA)
P M	UTi20T	90.5
K N	HTi05T	92.5
	HTi10	92.0
S	MT9005/RT9005	92.2
	MT9015/MT9010	91.8

Note 1) Hardness shows representative value of the substrate.

Memo











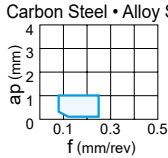

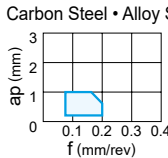

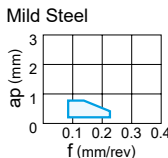
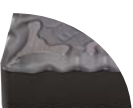
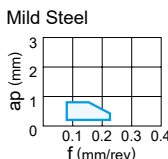
A series of horizontal dashed lines for writing.

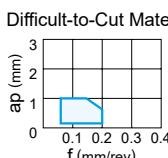
CLASSIFICATION

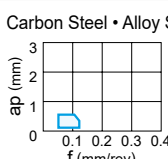
NEGATIVE INSERTS WITH HOLE

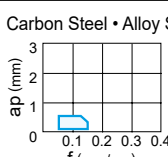
TURNING INSERTS

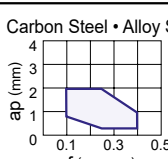
A

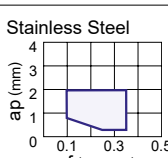
Application	Tolerance	Breaker Name and Picture	Features		Cross Section Geometry	
Finish Cutting	M	FP 	First recommendation for finish cutting of carbon steel and alloy steels Controls chip clogging during high-feed cutting and prevents chips of soft work materials from running onto their surfaces. Large rake angle controls vibrations and work deformation when machining low-rigidity workpieces.	Carbon Steel • Alloy Steel 	Corner: 20° Flank: 20° CNMG120408-FP	
		FH 	First recommendation for finish cutting of carbon steel and alloy steels Double sided chipbreaker. Stable chip control even at small depth of cut.	Carbon Steel • Alloy Steel 	Corner: 12° Flank: 12° CNMG120408-FH	
		FS 	Alternative chipbreaker for finish cutting of mild steel Stable chip control even at small depth of cut. Sharp edge gives best performance.	Mild Steel 	Corner: 16° Flank: 8° CNMG120408-FS	
		FY 	First recommendation for finish cutting of mild steel Effectively controls adhesive chips. Suitable for mild steel finishing.	Mild Steel 	Corner: 15° Flank: 15° 0.2 mm CNMG120408-FY	
	G	FJ 	Alternative chipbreaker for finish cutting of difficult-to-cut materials Ideal for heat-resistant alloy and titanium alloy. The sharp edge produces good cutting surface. The curved edge allows smooth chip discharge.	Difficult-to-Cut Materials 	Corner: 14° Flank: 9° CNGG120404-FJ	
		R/L-FS 	Precise finishing A narrow lead chipbreaker for good chip control. The sharp edge produces a good surface finish.	Carbon Steel • Alloy Steel 	Flank: 14° TNGG160404R-FS	
		R/L-F 	Finishing Lead chipbreaker controls chip flow. The sharp edge produces a good surface finish.	Carbon Steel • Alloy Steel 	Flank: 14° TNGG160404R-F	
	Light Cutting	M	LP 	First recommendation for light cutting of carbon and alloy steels Stable chip control in the light cutting range. The curved edge allows smooth chip discharge.	Carbon Steel • Alloy Steel 	0.1 mm Corner: 15° 0.2 mm Flank: 11° CNMG120408-LP
			LM 	First recommendation for light cutting of stainless steel Stable chip control at light cutting range. Breaker with high rake angle provides excellent burr control.	Stainless Steel 	0.50 mm Corner: 15° Flank: 20° CNMG120408-LM











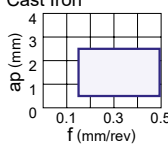

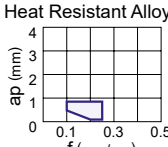

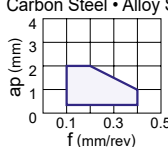

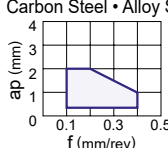
	Rhombic 80° 	Rhombic 55° 	Square 90° 	Triangular 60° 	Rhombic 35° 	Trigon 80° 	Round 	Breaker Name and Cross Section
	CNMG_FP  ↻ A098	DNMG_FP  ↻ A105	SNMG_FP  ↻ A113	TNMG_FP  ↻ A119	VNMG_FP  ↻ A126	WNMG_FP  ↻ A130		FP 
	CNMG_FH  ↻ A098	DNMG_FH  ↻ A105	SNMG_FH  ↻ A113	TNMG_FH  ↻ A119	VNMG_FH  ↻ A126	WNMG_FH  ↻ A130		FH 
	CNMG_FS  ↻ A098	DNMG_FS  ↻ A105	SNMG_FS  ↻ A113	TNMG_FS  ↻ A119	VNMG_FS  ↻ A126	WNMG_FS  ↻ A130		FS 
	CNMG_FY  ↻ A098	DNMG_FY  ↻ A105		TNMG_FY  ↻ A119		WNMG_FY  ↻ A130		FY 
	CNGG_FJ  ↻ A098	DNGG_FJ  ↻ A105			VNGG_FJ  ↻ A126			FJ 
				TNGG_R/L-FS  ↻ A119				R/L-FS 
				TNGG_R/L-F  ↻ A119	VNGG_R/L-F  ↻ A126			R/L-F 
	CNMG_LP  ↻ A098	DNMG_LP  ↻ A106	SNMG_LP  ↻ A113	TNMG_LP  ↻ A120	VNMG_LP  ↻ A126	WNMG_LP  ↻ A130		LP 
	CNMG_LM  ↻ A098	DNMG_LM  ↻ A106	SNMG_LM  ↻ A113	TNMG_LM  ↻ A120	VNMG_LM  ↻ A126	WNMG_LM  ↻ A130		LM 

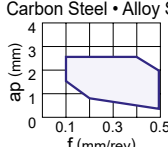
CLASSIFICATION

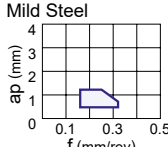
NEGATIVE INSERTS WITH HOLE

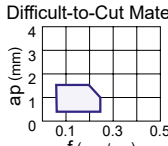
TURNING INSERTS

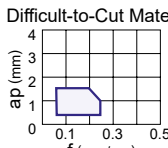
A

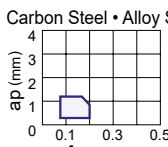
Application	Tolerance	Breaker Name and Picture	Features		Cross Section Geometry
Light Cutting	M	LK 	First recommendation for light cutting of cast iron Positive land allows sharp cutting edge and low cutting resistance.	Cast Iron 	Flank 15° 0.15 mm 6° CNMG120408-LK
		LS 	First recommendation for light cutting of difficult-to-cut materials. Alternative chipbreaker for light cutting of stainless steel Enhanced chip disposal for depths of cut smaller than the corner R.	Heat Resistant Alloy 	20° 0.4 mm Corner 20° 0.6 mm Flank CNMG120408-LS
		SH 	Alternative chipbreaker for light cutting of carbon and alloy steels Can be used at low depth of cuts and high feed rates. The curved edge allows smooth chip discharge. Recommended for workpieces in the 160–250HB range.	Carbon Steel • Alloy Steel 	15° Corner 15° 0.2 mm Flank CNMG120408-SH
		SA 	Alternative chipbreaker for light cutting of carbon and alloy steels Superior chip control at small depth of cuts. Covers copying and back turning with wavy edge. Recommended for workpieces in the 200–300HB range.	Carbon Steel • Alloy Steel 	25° 0.3 mm Corner 10° 25° 0.34 mm Flank 8° CNMG120408-SA
		SW 	Wiper insert for light cutting of carbon, alloy and stainless steels, and cast iron In comparison to conventional chipbreakers, the surface finish is maintained even if the feed per revolution is doubled. Wiper design for increased productivity and improved surface finish.	Carbon Steel • Alloy Steel 	18° 0.15 mm Corner 7° 18° 0.15 mm Flank 7° CNMG120408-SW
		SY 	First recommendation for light cutting of mild steel Effectively controls adhesive chips. Suitable for mild steel light cutting.	Mild Steel 	10° Corner 10° 0.2 mm Flank CNMG120408-SY
		MJ 	Alternative chipbreaker for light cutting of difficult-to-cut materials Ideal for heat-resistant alloy and titanium alloy. The sharp edge produces a good surface finish. The curved edge allows smooth chip discharge. Excellent notch wear resistance for light to medium cutting.	Difficult-to-Cut Materials 	13° Corner 9° Flank CNMG120408-MJ
		MJ 	Alternative chipbreaker for light cutting of difficult-to-cut materials Double sided chipbreaker, single sided chipbreaker (D type, V type). The sharp edge produces a good surface finish. Ideal for heat-resistant and titanium alloy. The curved edge allows smooth chip discharge.	Difficult-to-Cut Materials 	13° Corner 9° Flank CNGG120408-MJ
		R/L-K 	Light cutting Parallel chipbreaker. Excellent chip control at low to medium feed rates.	Carbon Steel • Alloy Steel 	Flank 14° 0.25 mm TNGG160404R-K









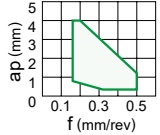
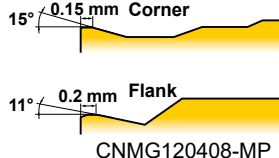

	Rhombic 80° 	Rhombic 55° 	Square 90° 	Triangular 60° 	Rhombic 35° 	Trigon 80° 	Round 	Breaker Name and Cross Section
	CNMG_LK  ↻ A099	DNMG_LK  ↻ A106	SNMG_LK  ↻ A113	TNMG_LK  ↻ A120	VNMG_LK  ↻ A127	WVNMG_LK  ↻ A131		LK 
	CNMG_LS  ↻ A099	DNMG_LS  ↻ A106		TNMG_LS  ↻ A120	VNMG_LS  ↻ A127	WVNMG_LS  ↻ A131		LS 
	CNMG_SH  ↻ A099	DNMG_SH  ↻ A106	SNMG_SH  ↻ A113	TNMG_SH  ↻ A120	VNMG_SH  ↻ A127	WVNMG_SH  ↻ A131		SH 
	CNMG_SA  ↻ A099	DNMG_SA  ↻ A107	SNMG_SA  ↻ A114	TNMG_SA  ↻ A120	VNMG_SA  ↻ A127	WVNMG_SA  ↻ A131		SA 
	CNMG_SW  ↻ A099	DNMX_SW  ↻ A107		TNMX_SW  ↻ A120		WVNMG_SW  ↻ A131		SW 
	CNMG_SY  ↻ A099	DNMG_SY  ↻ A107	SNMG_SY  ↻ A114	TNMG_SY  ↻ A121		WVNMG_SY  ↻ A131		SY 
	CNMG_MJ  ↻ A099	DNMG_MJ  ↻ A107		TNMG_MJ  ↻ A121	VNMG_MJ  ↻ A127	WVNMG_MJ  ↻ A131		MJ(M) 
	CNMG_MJ  ↻ A099	DNGM_MJ  ↻ A107			VNMG_MJ  ↻ A127			MJ(G) 
				TNMG_R/L-K  ↻ A121				R/L-K 

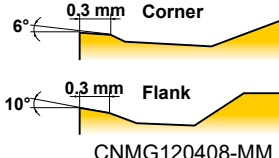

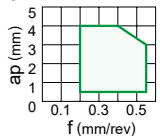
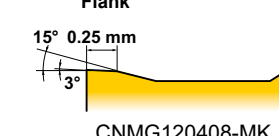
CLASSIFICATION

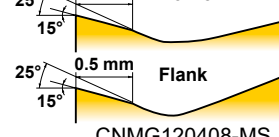
NEGATIVE INSERTS WITH HOLE

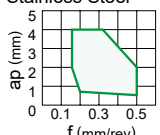
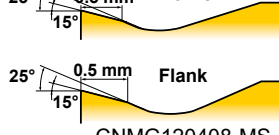
TURNING INSERTS

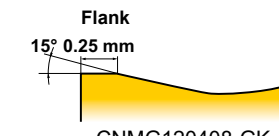
A

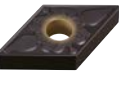
Application	Tolerance	Breaker Name and Picture	Features		Cross Section Geometry
Medium Cutting M		MP 	First recommendation for medium cutting of carbon and alloy steels Suitable for medium to light cutting. Breaker geometry appropriate for copying and back turning. Cutting edge geometry for an optimum balance of sharpness and fracture resistance.	Carbon Steel • Alloy Steel 	15° 0.15 mm Corner 11° 0.2 mm Flank CNMG120408-MP
		MM 	First recommendation for medium cutting of stainless steel Optimized land geometry by simulation analysis technology controls the plastic deformation of the corner and achieves the long tool life.	Stainless Steel 	6° 0.3 mm Corner 10° 0.3 mm Flank CNMG120408-MM
		MK 	First recommendation for medium cutting of cast iron Optimum balance between sharpness and high edge strength for general use.	Cast Iron 	Flank 15° 0.25 mm 3° CNMG120408-MK
		MS 	First recommendation for medium cutting of stainless steel, and mild steels, and difficult-to-cut materials The large 2-step rake angle generates chips smoothly and without tangling during low feed cutting.	Difficult-to-Cut Materials 	25° 0.5 mm Corner 15° 25° 0.5 mm Flank 15° CNMG120408-MS
		MS 	Alternative chipbreaker for medium cutting of stainless and mild steels, and difficult-to-cut materials The sharp edge gives best performance. Flat top breaker shape offers high edge strength. Applicable to grades other than MP9005, MP9015, MP9025, MT9015	Stainless Steel 	25° 0.5 mm Corner 15° 25° 0.5 mm Flank 15° CNMG120408-MS
		GK 	Alternative chipbreaker for medium cutting of cast iron Versatile standard breaker. Flat land maintains a stable cutting edge.	Cast Iron 	Flank 15° 0.25 mm CNMG120408-GK
		GM 	Alternative chipbreaker for light to medium cutting of stainless steel Alternative chipbreaker of main chipbreaker LM and MM. Excellent notch wear resistance for light to medium cutting.	Stainless Steel 	25° 0.5 mm Corner 15° 25° 0.5 mm Flank 15° CNMG120408-GM
		MA 	Multi-assist breaker Ideal for general cutting applications. Positive land provides sharp cutting action	Carbon Steel • Alloy Steel 	22° 0.2 mm Corner 6° 22° 0.2 mm Flank 6° CNMG120408-MA
		MH 	Alternative chipbreaker for medium cutting of carbon and alloy steels First recommendation for rough cutting of mild steel Good chip control with suitable chip pocket	Carbon Steel • Alloy Steel 	16° 0.25 mm Corner 16° 0.35 mm Flank CNMG120408-MH











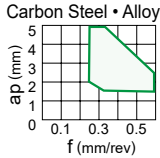

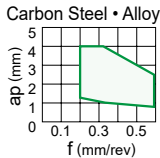

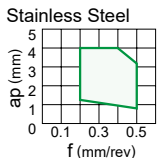

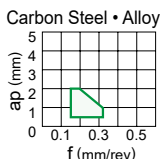
	Rhombic 80° 	Rhombic 55° 	Square 90° 	Triangular 60° 	Rhombic 35° 	Trigon 80° 	Round 	Breaker Name and Cross Section
	CNMG_MP  ↻ A100	DNMG_MP  ↻ A107	SNMG_MP  ↻ A114	TNMG_MP  ↻ A121	VNMG_MP  ↻ A127	WNMG_MP  ↻ A132		MP 
	CNMG_MM  ↻ A100	DNMG_MM  ↻ A107	SNMG_MM  ↻ A114	TNMG_MM  ↻ A121	VNMG_MM  ↻ A127	WNMG_MM  ↻ A132		MM 
	CNMG_MK  ↻ A100	DNMG_MK  ↻ A108	SNMG_MK  ↻ A114	TNMG_MK  ↻ A121	VNMG_MK  ↻ A127	WNMG_MK  ↻ A132		MK 
	CNMG_MS  ↻ A100	DNMG_MS  ↻ A108	SNMG_MS  ↻ A114	TNMG_MS  ↻ A121	VNMG_MS  ↻ A128	WNMG_MS  ↻ A132		MS 
	CNMG_MS  ↻ A101	DNMG_MS  ↻ A108	SNMG_MS  ↻ A115	TNMG_MS  ↻ A121	VNMG_MS  ↻ A128	WNMG_MS  ↻ A132		MS 
	CNMG_GK  ↻ A101	DNMG_GK  ↻ A108	SNMG_GK  ↻ A115	TNMG_GK  ↻ A121	VNMG_GK  ↻ A128	WNMG_GK  ↻ A133		GK 
	CNMG_GM  ↻ A101	DNMG_GM  ↻ A108	SNMG_GM  ↻ A115	TNMG_GM  ↻ A122	VNMG_GM  ↻ A128	WNMG_GM  ↻ A133		GM 
	CNMG_MA  ↻ A101	DNMG_MA  ↻ A109	SNMG_MA  ↻ A115	TNMG_MA  ↻ A122	VNMG_MA  ↻ A128	WNMG_MA  ↻ A133		MA 
	CNMG_MH  ↻ A101	DNMG_MH  ↻ A109	SNMG_MH  ↻ A115	TNMG_MH  ↻ A122	VNMG_MH  ↻ A128	WNMG_MH  ↻ A133		MH 

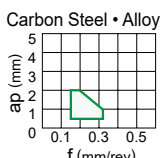

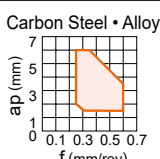
CLASSIFICATION

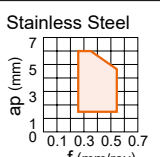
NEGATIVE INSERTS WITH HOLE

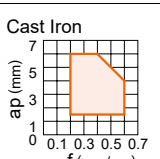
TURNING INSERTS

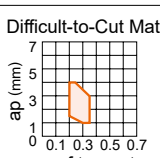
A











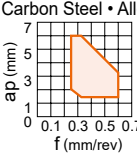

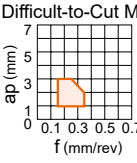

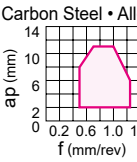

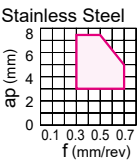
Application	Tolerance	Breaker Name and Picture	Features		Cross Section Geometry
Medium Cutting	M	Standard 	Alternative chipbreaker for medium cutting of carbon and alloy steels First recommendation for medium cutting of cast iron Flat land offers high edge strength. Flat top breaker shape offers high edge strength.	Carbon Steel • Alloy Steel 	15° 0.25 mm Corner 15° 0.25 mm Flank CNMG120408
		MW 	Wiper insert for medium cutting carbon, alloy and, stainless steels, and cast iron The wiper allows up to two times higher feed. A wide chip pocket prevents chip jamming.	Carbon Steel • Alloy Steel 	19° 0.25 mm Corner 19° 0.3 mm Flank CNMG120408-MW
		R/L-ES 	Alternative chipbreaker for medium cutting of stainless steel Good balance of edge strength and sharpness. Right- or left-hand breaker for unidirectional chip control.	Stainless Steel 	15° 0.16 mm Flank TNMG160404R-ES
		R/L-2G 	Alternative chipbreaker for medium cutting of carbon and alloy steel Parallel chipbreaker controls chip flow. Suitable for light to medium cutting.	Carbon Steel • Alloy Steel 	14° 0.2 mm Flank TNMG160404R-2G
		R/L 	Medium cutting Parallel chipbreaker. Good chip control for medium feed rates.	Carbon Steel • Alloy Steel 	14° 0.25 mm Flank TNGG160408R
Rough Cutting	M	RP 	First recommendation for rough cutting of carbon and alloy steels For interrupted cuts and removing scale. Good balance of cutting edge strength and low cutting resistance because of suitable rake angle.	Carbon Steel • Alloy Steel 	3° 0.33 mm Corner 0.33 mm Flank CNMG120408-RP
		RM 	First recommendation for rough cutting of stainless steel Excellent fracture resistance at interrupted cutting due to the optimum land angle and honing geometry.	Stainless Steel 	3° 0.32 mm Corner 6° 0.32 mm Flank CNMG120408-RM
		RK 	First recommendation for rough cutting of cast iron Extra wide land provides a stable cutting edge for interrupted machining and removal of scale.	Cast Iron 	15° 0.35 mm Flank CNMG120408-RK
		RS 	First recommendation for rough cutting of difficult-to-cut materials Alternative chipbreaker for rough cutting of stainless steel During low speed cutting the positive land controls chip welding and abrasion at the depth of cut line.	Difficult-to-Cut Materials 	20° 0.2 mm Corner 10° 0.2 mm Flank CNMG120408-RS

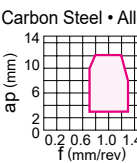

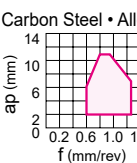

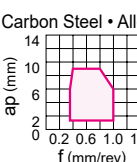

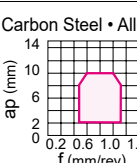

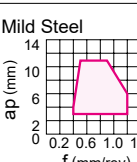









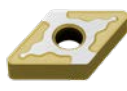





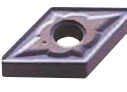











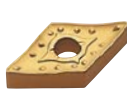

	Rhombic 80° 	Rhombic 55° 	Square 90° 	Triangular 60° 	Rhombic 35° 	Trigon 80° 	Round 	Breaker Name and Cross Section
	CNMG  ↻ A102	DNMG  ↻ A109	SNMG  ↻ A115	TNMG  ↻ A122	VNMG  ↻ A128	WNMG  ↻ A133	RNMG  ↻ A112	Standard 
	CNMG_MW  ↻ A102	DNMX_MW  ↻ A109		TNMX_MW  ↻ A123		WNMG_MW  ↻ A133		MW 
				TNMG_R/L-ES  ↻ A123				R/L-ES 
				TNMG_R/L-2G  ↻ A123				R/L-2G 
		DNGG_R/L  ↻ A109	SNGG_R/L  ↻ A116	TNGG_R/L  ↻ A123	VNGG_R/L  ↻ A129			R/L 
	CNMG_RP  ↻ A102	DNMG_RP  ↻ A109	SNMG_RP  ↻ A116	TNMG_RP  ↻ A123		WNMG_RP  ↻ A133		RP 
	CNMG_RM  ↻ A102	DNMG_RM  ↻ A110	SNMG_RM  ↻ A116	TNMG_RM  ↻ A123		WNMG_RM  ↻ A133		RM 
	CNMG_RK  ↻ A103	DNMG_RK  ↻ A110	SNMG_RK  ↻ A116	TNMG_RK  ↻ A124		WNMG_RK  ↻ A134		RK 
	CNMG_RS  ↻ A103	DNMG_RS  ↻ A110	SNMG_RS  ↻ A116	TNMG_RS  ↻ A124		WNMG_RS  ↻ A134		RS 

CLASSIFICATION

NEGATIVE INSERTS WITH HOLE

TURNING INSERTS

Application	Tolerance	Breaker Name and Picture	Features		Cross Section Geometry
Rough Cutting	M	GH 	Alternative chipbreaker for rough cutting of carbon and alloy steels, and cast iron For interrupted cuts and removing scale. A combination of wide land and a large chip pocket allows high feed rates.	Carbon Steel • Alloy Steel 	18° 0.32 mm Corner 18° 0.32 mm Flank CNMG120408-GH
		GJ 	Alternative chipbreaker for rough cutting of difficult-to-cut materials Excellent balance of edge sharpness and strength. Edge geometry with high face wear resistance.	Difficult-to-Cut Materials 	18° 0.15 mm Corner 18° 0.15 mm Flank CNMG120408-GJ
Heavy Cutting	M	HX 	First recommendation for heavy cutting of carbon and alloy steels Covers the medium range of the heavy cutting region. Owing to the straight edge and chamfer, it gives a balance of sharpness and strength. Variable land and a wavy chipbreaker for good chip control.	Carbon Steel • Alloy Steel 	23° 0.43 mm Corner 21° 0.52 mm Flank CNMM190616-HX
		HL 	First recommendation for heavy cutting of stainless steel Alternative chipbreaker for heavy cutting of carbon and alloy steels Covers the lower end of the heavy cutting region. The curved edge and narrow chamfer allow good chip control and sharp cutting action. Dots on the nose radius ensure chip control at low depths of cut.	Stainless Steel 	15° 0.34 mm CNMM190616-HL
		HR 	Alternative chipbreaker for heavy cutting of carbon and alloy steels Covers the heavy cutting region by using a straight cutting edge with high edge strength. It exhibits smooth chip control during large depths of cut and high feed rate machining.	Carbon Steel • Alloy Steel 	20° 0.58 mm CNMM250924-HR
		HV 	Alternative chipbreaker for heavy cutting of carbon and alloy steels Covers the upper end of the heavy cutting region. Wide land and large chamfer offer high edge strength. A wide chipbreaker prevents chip jamming.	Carbon Steel • Alloy Steel 	20° 0.68 mm Corner 20° 0.68 mm Flank SNMM190616-HV
		HZ 	Alternative chipbreaker for heavy cutting of carbon and alloy steels Covers the lower end of the heavy cutting region. Low cutting resistance due to positive land and curved edge. Teardrop dots improve chip control without increasing cutting resistance.	Carbon Steel • Alloy Steel 	22° 0.42 mm Corner 6° 22° 0.42 mm Flank 6° CNMM190616-HZ
		HM 	Alternative chipbreaker for heavy cutting of carbon, alloy and stainless steels Covers the lower end through to the medium range of the heavy cutting region. The curved edge and narrow chamfer allow good chip control and sharp cutting action. Teardrop dots provided along the cutting edge ensures chip control even with variable depths of cut.	Carbon Steel • Alloy Steel 	16° 0.32 mm CNMM190616-HM
		HXD 	Alternative chipbreaker for heavy cutting of mild and stainless steels Covers the lower end through to the medium range of the heavy cutting region. Balance of sharpness and strength owing to a narrow chamfer and variable land.	Mild Steel 	25° 0.35 mm Corner 30° 0.55 mm Flank SNMM250724





	Rhombic 80° 	Rhombic 55° 	Square 90° 	Triangular 60° 	Rhombic 35° 	Trigon 80° 	Round 	Breaker Name and Cross Section
	CNMG_GH  ↻ A103	DNMG_GH  ↻ A110	SNMG_GH  ↻ A117	TNMG_GH  ↻ A124		WNMG_GH  ↻ A134		GH 
	CNMG_GJ  ↻ A103	DNMG_GJ  ↻ A110				WNMG_GJ  ↻ A134		GJ 
	CNMM_HX  ↻ A103		SNMM_HX  ↻ A117					HX 
	CNMM_HL  ↻ A103	DNMM_HL  ↻ A110	SNMM_HL  ↻ A117	TNMM_HL  ↻ A124				HL 
	CNMM_HR  ↻ A104		SNMM_HR  ↻ A117					HR 
	CNMM_HV  ↻ A104		SNMM_HV  ↻ A117					HV 
	CNMM_HZ  ↻ A104	DNMM_HZ  ↻ A111	SNMM_HZ  ↻ A117	TNMM_HZ  ↻ A124				HZ 
	CNMM_HM  ↻ A104		SNMM_HM  ↻ A117					HM 
			SNMM_HXD  ↻ A118					HXD 





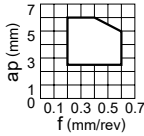

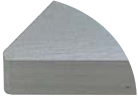
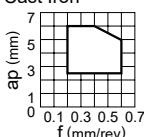









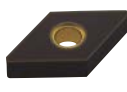

CLASSIFICATION

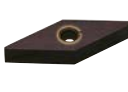
NEGATIVE INSERTS WITH HOLE

A

TURNING INSERTS

Application	Tolerance	Breaker Name and Picture	Features	Cross Section Geometry
For Cast Iron	M	<p>Flat Top</p> 	<p>First recommendation for heavy cutting of cast iron Most effective for unstable machining due to its high edge strength.</p>	<p>Cast Iron</p>  <p>0°</p>  <p>CNMA120408</p>
	G	<p>Flat Top</p> 	<p>For heavy cutting of cast iron Most effective for unstable machining due to its high edge strength. Can be used on workpieces requiring close tolerances due to G class insert tolerance.</p>	<p>Cast Iron</p>  <p>0°</p>  <p>DNGA150408</p>

	Rhombic 80° 	Rhombic 55° 	Square 90° 	Triangular 60° 	Rhombic 35° 	Trigon 80° 	Round 	Breaker Name and Cross Section
	CNMA  ↻ A104	DNMA  ↻ A111	SNMA  ↻ A118	TNMA  ↻ A125	VNMA  ↻ A129	WNMA  ↻ A134		Flat Top(M) 
		DNGA  ↻ A111	SNGA  ↻ A118	TNGA  ↻ A125	VNGA  ↻ A129			Flat Top(G) 

A











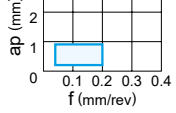
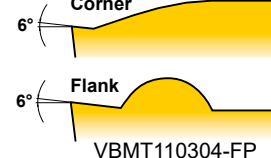

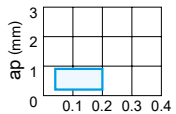
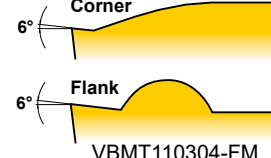

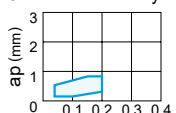
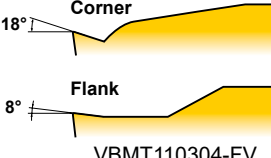
TURNING INSERTS

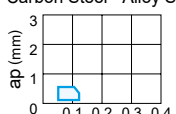
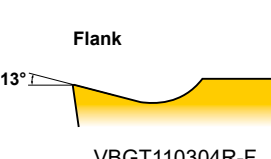

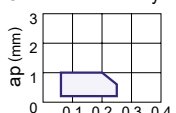
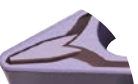
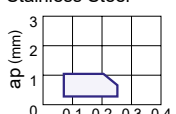
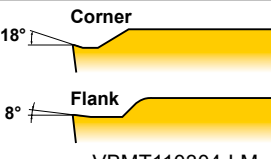

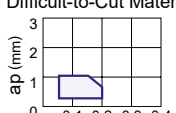
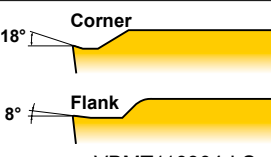

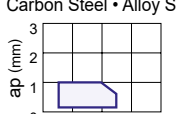
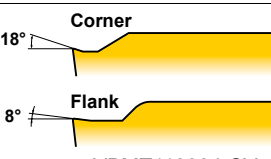

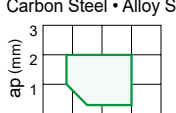
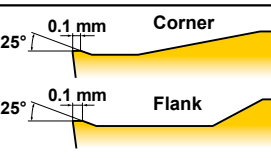













CLASSIFICATION

5° POSITIVE INSERTS WITH HOLE

TURNING INSERTS

A

Application	Tolerance	Breaker Name and Picture	Features		Cross Section Geometry
Finish Cutting	M	FP 	First recommendation for finish cutting of carbon, alloy and mild steels Breaker protrusion at the corner tip controls chips even at small depth of cut. Maintains the edge strength at the corner and prevents sudden fractures.	Carbon Steel • Alloy Steel 	 Corner 6° Flank 6° VBMT110304-FP
		FM 	First recommendation for finish cutting of stainless steel Breaker protrusion at the corner tip controls chips even at small depth of cut. Maintains the edge strength at the corner and prevents sudden fractures.	Stainless Steel 	 Corner 6° Flank 6° VBMT110304-FM
		FV 	First recommendation for finish cutting of carbon, alloy, mild and stainless steels Suitable for low depths of cut and low feed rates. Sharp cutting edge and low resistance design achieves excellent cutting performance.	Carbon Steel • Alloy Steel 	 Corner 18° Flank 8° VBMT110304-FV
	G	R/L-F 	Finishing Lead chipbreaker controls chip flow. Sharp cutting edge gives a good surface finish.	Carbon Steel • Alloy Steel 	 Flank 13° VBGT110304R-F
	Light Cutting	M	LP 	First recommendation for light cutting of carbon steel and alloy steel Sharp cutting edge due to a large rake angle. Prevents welding of the insert and controls white turbidity of the surface finish. Breaker protrusion suitable for depth of cut area achieves a wide range of chip control.	Carbon Steel • Alloy Steel 
LM 			First recommendation for light cutting of stainless steel Sharp cutting edge due to a large rake angle. Prevents welding of the insert and controls white turbidity of the surface finish. Breaker protrusion suitable for depth of cut area achieves a wide range of chip control.	Stainless Steel 	 Corner 18° Flank 8° VBMT110304-LM
NEW LS 			First recommendation for light cutting of difficult-to-cut materials Prevents welding of the insert and controls white turbidity of the surface finish.	Difficult-to-Cut Materials 	 Corner 18° Flank 8° VBMT110304-LS
SV 			Alternative chipbreaker for carbon steel, alloy steel and stainless steel Large rake angle provides sharp cutting action. A peninsular dot ensures chip control at depths of cut under 1mm.	Carbon Steel • Alloy Steel 	 Corner 18° Flank 8° VBMT110304-SV
M		MP 	First recommendation for medium cutting of carbon steel, alloy steel and mild steel Good balance of wear resistance and fracture resistance because of the flat land cutting edge. A wide chip pocket controls increasing of the cutting resistance and reduces vibration and chip jamming even at large depth of cut.	Carbon Steel • Alloy Steel 	 Corner 25° 0.1 mm Flank 25° 0.1 mm VBMT160404-MP

	Rhombic 80° 	Rhombic 55° 	Square 90° 	Triangular 60° 	Rhombic 35° 	Trigon 80° 	Round 	Breaker Name and Cross Section
					VBMT_FP  ⊕ A164			FP 
					VBMT_FM  ⊕ A164			FM 
					VBMT_FV  ⊕ A164			FV 
					VBGT_R/L-F  ⊕ A164	WBG_T_R/L-F  ⊕ A172		R/L-F 
					VBMT_LP  ⊕ A164			LP 
					VBMT_LM  ⊕ A164			LM 
					NEW VBMT_LS  ⊕ A165			NEW LS 
					VBMT_SV  ⊕ A165			SV 
					VBMT_MP  ⊕ A165			MP 

A











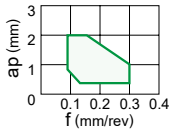
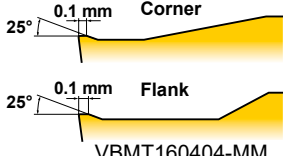

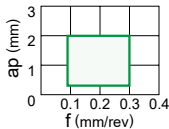
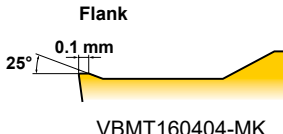
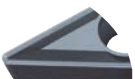
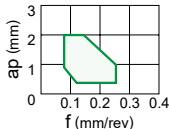
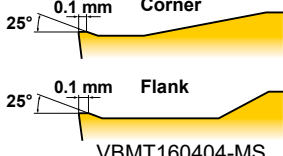

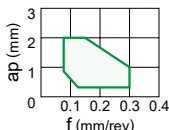
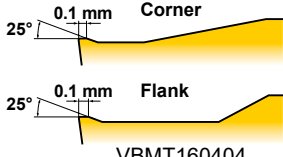
TURNING INSERTS

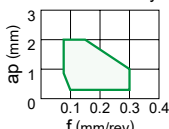
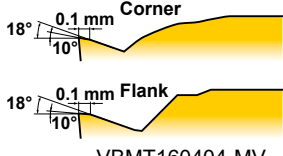

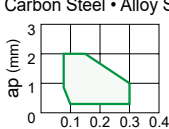
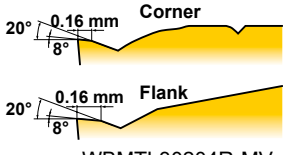

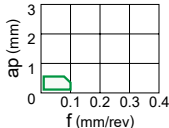
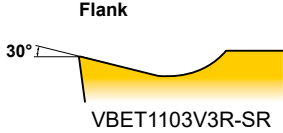
CLASSIFICATION

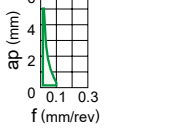
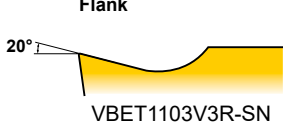
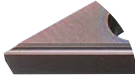
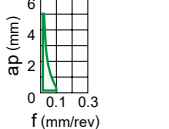
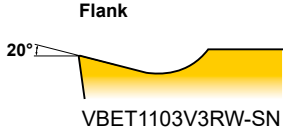
5° POSITIVE INSERTS WITH HOLE

TURNING INSERTS

A

Application	Tolerance	Breaker Name and Picture	Features		Cross Section Geometry
Medium Cutting	M	MM 	First recommendation for medium cutting of stainless steel Good balance of wear resistance and fracture resistance because of the flat land cutting edge. A wide chip pocket controls increasing of the cutting resistance and reduces vibration and chip jamming even at large depth of cut.	Stainless Steel 	 VBMT160404-MM
		MK 	First recommendation for medium cutting of cast iron Optimum balance between sharpness and high edge strength for general use.	Cast Iron 	 VBMT160404-MK
		MS 	First recommendation for medium cutting of difficult-to-cut materials Ideal for heat-resistant alloy and titanium alloy and cobalt chrome alloy. A wide chip pocket controls increasing of the cutting resistance and reduces vibration and chip jamming even at large depth of cut.	Difficult-to-Cut Materials 	 VBMT160404-MS
		Standard 	Alternative chipbreaker for medium cutting of carbon, alloy and stainless steels Balance of edge strength and sharpness due to a combination of a flat land and large rake angle.	Carbon Steel • Alloy Steel 	 VBMT160404
		MV 	Alternative chipbreaker for medium cutting of carbon, alloy, mild and stainless steels A positive insert with a large rake angle achieves sharp cutting edge performance. The double breakers and round-shaped dots in the rake face achieve a wide range of chip discharge.	Carbon Steel • Alloy Steel 	 VBMT160404-MV
		R/L-MV 	Alternative chipbreaker for medium cutting of carbon, alloy, mild and stainless steels A positive insert with a large rake angle achieves sharp cutting edge performance. The double breakers and round-shaped dots in the rake face achieve a wide range of chip discharge.	Carbon Steel • Alloy Steel 	 WBMTL30204R-MV
		R/L-SR 	Medium cutting on automatic lathes A wide lead chipbreaker. Insert designed for low resistance chip control.	Carbon Steel • Alloy Steel 	 VBET1103V3R-SR
		R/L-SN 	Medium cutting on automatic lathes A parallel chipbreaker. Excellent chip control for low to medium feed rates.	Carbon Steel • Alloy Steel 	 VBET1103V3R-SN
		R/LW-SN 	Medium cutting on automatic lathes A parallel chipbreaker. Excellent chip control for low to medium feed rates. The wiper produces good cutting surface.	Carbon Steel • Alloy Steel 	 VBET1103V3RW-SN
		For Cast Iron	M	Flat Top 	Rough cutting of cast iron Flat top. Most effective for unstable machining due to its high edge strength.

	Rhombic 80° 	Rhombic 55° 	Square 90° 	Triangular 60° 	Rhombic 35° 	Trigon 80° 	Round 	Breaker Name and Cross Section
					VBMT_MM  A165			MM 
					VBMT_MK  A165			MK 
					VBMT_MS  A165			MS 
					VBMT  A165			Standard 
					VBMT_MV  A165			MV 
						WBMT_R/L-MV  A172		R/L-MV 
					VBET_R/L-SR  A166			R/L-SR 
					VBET_R/L-SN  A166			R/L-SN 
					VBET_R/LW-SN  A166			R/LW-SN 
					VBMW  A166			Flat Top 

A











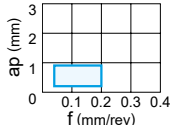
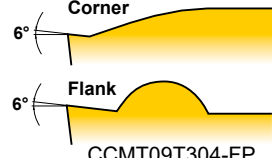

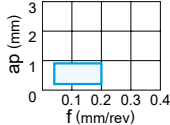
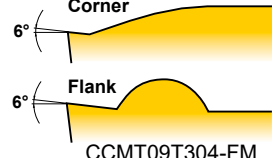

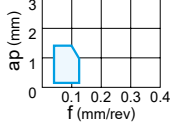
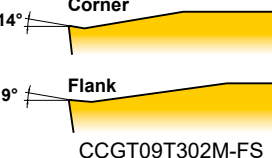

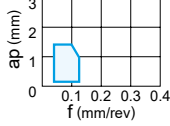
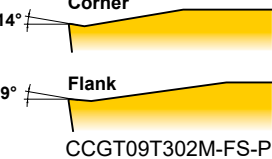
TURNING INSERTS

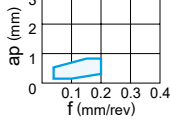
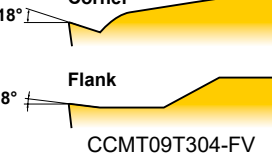
CLASSIFICATION

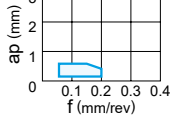
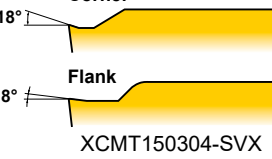
7° POSITIVE INSERTS WITH HOLE

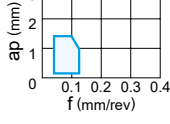
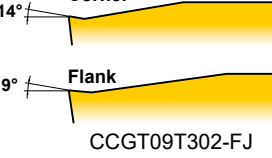
TURNING INSERTS

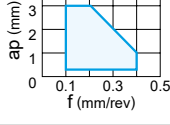
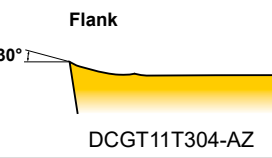
A

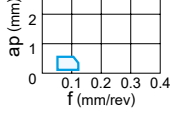
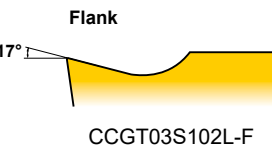
Application	Tolerance	Breaker Name and Picture	Features		Cross Section Geometry
M		FP 	First recommendation for finish cutting of carbon steel, alloy and mild steels Breaker protrusion at the corner tip controls chips even at small depth of cut. Maintains the edge strength at the corner and prevents sudden fractures.	Carbon Steel • Alloy Steel 	 6° Corner 6° Flank CCMT09T304-FP
		FM 	First recommendation for finish cutting of stainless steel Breaker protrusion at the corner tip controls chips even at small depth of cut. Maintains the edge strength at the corner and prevents sudden fractures.	Stainless Steel 	 6° Corner 6° Flank CCMT09T304-FM
G		FS 	First recommendation for finish cutting of difficult-to-cut materials Ideal for heat-resistant alloys, titanium alloys, and cobalt chrome alloys. Sharp cutting edges provide excellent surface precision. Highly efficient chip discharge is possible due to curved cutting edges.	Difficult-to-Cut Materials 	 14° Corner 9° Flank CCGT09T302M-FS
		FS-P 	First recommendation for finish cutting of titanium alloys Ideal for titanium alloys and copper alloys. Sharp cutting edges provide excellent surface precision. Highly efficient chip discharge is possible due to curved cutting edges. Polished (mirror-surface) finish of insert surfaces drastically improves welding resistance extending tool life.	Titanium Alloy 	 14° Corner 9° Flank CCGT09T302M-FS-P
M	Finish Cutting	FV 	Alternative chipbreaker for finish cutting of carbon, alloy, mild and stainless steels Suitable for low depths of cut and low feed rates. Sharp cutting edge and low resistance design achieves excellent cutting performance.	Carbon Steel • Alloy Steel 	 18° Corner 8° Flank CCMT09T304-FV
		SVX 	Alternative chipbreaker for light cutting of carbon and alloy steels Chip control is improved by having a chipbreaker geometry suitable for copying.	Carbon Steel • Alloy Steel 	 18° Corner 8° Flank XCMT150304-SVX
G		FJ 	Alternative chipbreaker for light cutting of carbon and alloy steels Ideal for heat-resistant alloy and titanium alloy. The sharp edge produces a good surface finish. The curved edge allows smooth chip discharge.	Difficult-to-Cut Materials 	 14° Corner 9° Flank CCGT09T302-FJ
		AZ 	For aluminium alloy The high rake angle and 3D curved cutting edge provides sharpness at the cutting point. Additionally the 3D shape of the rake face enables excellent chip control. Lapping of the top surface gives a mirror finish for improved welding resistance.	Aluminium Alloy 	 30° Flank DCGT11T304-AZ
		R/L-F 	Finishing Lead chipbreaker controls chip flow. Sharp cutting edge gives a good surface finish.	Carbon Steel • Alloy Steel 	 17° Flank CCGT03S102L-F









	Rhombic 80° 	Rhombic 55° 	Square 90° 	Triangular 60° 	Rhombic 35° 	Trigon 80° 	Rhombic 25° 	Round 	Breaker Name and Cross Section
	CCMT_FP  ↻ A139	DCMT_FP  ↻ A147	SCMT_FP  ↻ A155	TCMT_FP  ↻ A158	VCMT_FP  ↻ A167				FP 
	CCMT_FM  ↻ A139	DCMT_FM  ↻ A147	SCMT_FM  ↻ A155	TCMT_FM  ↻ A158	VCMT_FM  ↻ A167				FM 
	CCGT_FS  ↻ A139	DCGT_FS  ↻ A147							FS 
	CCGT_FS-P  ↻ A139	DCGT_FS-P  ↻ A147							FS-P 
	CCMT_FV  ↻ A139	DCMT_FV  ↻ A147	SCMT_FV  ↻ A155	TCMT_FV  ↻ A158	VCMT_FV  ↻ A167				FV 
								XCMT_SVX  ↻ A175	SVX 
	CCGT_FJ  ↻ A139								FJ 
	CCGT_AZ  ↻ A140	DCGT_AZ  ↻ A147		TCGT_AZ  ↻ A158	VCGT_AZ  ↻ A167			RCGT_AZ  ↻ A154	AZ 
	CCGT_L-F CCGH_R/L-F  ↻ A140	DCGT_R/L-F  ↻ A148		TCGT_R/L-F  ↻ A158	VCGT_R/L-F  ↻ A167				R/L-F 

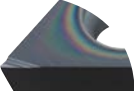



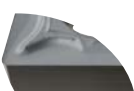





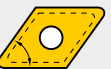







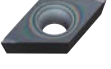

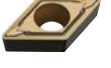





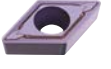





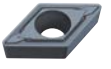







CLASSIFICATION

7° POSITIVE INSERTS WITH HOLE

TURNING INSERTS

A

Application	Tolerance	Breaker Name and Picture	Features		Cross Section Geometry
Finish Cutting	G	R/L 	Finishing Lead chipbreaker. Excellent chip control at low feed rates.	Carbon Steel • Alloy Steel	 WCGT020104R
		NEW R-SRF 	Finishing Lead chipbreaker controls chip flow. Sharp cutting edge gives a good surface finish.	Carbon Steel • Alloy Steel • Stainless Steel • Difficult-to-Cut Materials	 DCGT11T301MR-SRF
Light Cutting	M	LP 	First recommendation for light cutting of carbon, alloy and mild steels Sharp cutting edge due to a large rake angle. Prevents welding of the insert and controls white turbidity of the surface finish. Breaker protrusion suitable for depth of cut area achieves a wide range of chip control.	Carbon Steel • Alloy Steel	 CCMT09T308-LP
		LM 	First recommendation for light cutting of stainless steel Sharp cutting edge due to a large rake angle. Prevents welding of the insert and controls white turbidity of the surface finish. Breaker protrusion suitable for depth of cut area achieves a wide range of chip control.	Stainless Steel	 CCMT09T308-LM
		LS 	First recommendation for light cutting of difficult-to-cut materials Prevents welding of the insert and controls cloudy surface of the surface finish.	Difficult-to-Cut Materials	 CCMT09T308-LS
Light Cutting	G	LS 	First recommendation for light cutting of difficult-to-cut materials Ideal for heat resistant alloys, titanium alloys, and cobalt chromium alloys. Designed with parallel cutting edges. Achieves stable chip control over a wide range from low to medium depths of cut.	Difficult-to-Cut Materials	 CCGT09T304M-LS
		LS-P 	First recommendation for light cutting of titanium alloys Ideal for titanium alloys and copper alloys. Designed with parallel cutting edges. Achieves stable chip control over a wide range from low to medium depths of cut. Polished (mirror-surface) finish of insert surfaces drastically improves welding resistance extending tool life.	Titanium Alloy	 CCGT09T304M-LS-P
Light Cutting	M	SV 	Alternative chipbreaker for light cutting of carbon steel, alloy, mild and stainless steels Large rake angle provides sharp cutting action. A peninsular dot ensures chip control at depths of cut under 1mm.	Carbon Steel • Alloy Steel	 CCMH060204-SV
		SW 	Wiper insert for light cutting of carbon, alloy, mild and stainless steels The wiper allows up to double the feed rate. Positive land improves sharpness.	Carbon Steel • Alloy Steel	 CCMT09T304-SW











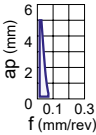
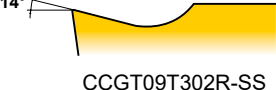

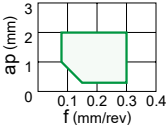
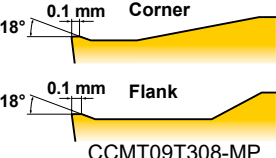

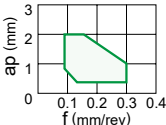
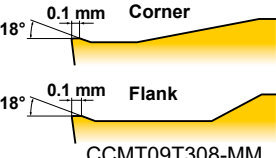
	Rhombic 80° 	Rhombic 55° 	Square 90° 	Triangular 60° 	Rhombic 35° 	Trigon 80° 	Round 	Breaker Name and Cross Section
						WCGT_R/L  ↻ A173		R/L 
		DCGT_R-SRF <small>NEW</small>  ↻ A148						<small>NEW</small> R-SRF 
	CCMT_LP  ↻ A141	DCMT_LP  ↻ A148	SCMT_LP  ↻ A155	TCMT_LP  ↻ A159	VCMT_LP  ↻ A167			LP 
	CCMT_LM  ↻ A141	DCMT_LM  ↻ A148	SCMT_LM  ↻ A155	TCMT_LM  ↻ A159	VCMT_LM  ↻ A167			LM 
	CCMT_LS  ↻ A141	DCMT_LS  ↻ A148		<small>NEW</small> TCMT_LS  ↻ A159	VCMT_LS  ↻ A168			LS(M) 
	CCGT_LS  ↻ A141	DCGT_LS  ↻ A148			VCGT_LS  ↻ A168			LS(G) 
	CCGT_LS-P  ↻ A141	DCGT_LS-P  ↻ A149			VCGT_LS-P  ↻ A168			LS-P 
	CCMH_SV  ↻ A141	DCMT_SV  ↻ A149			VCMT_SV  ↻ A168			SV 
	CCMT_SW  ↻ A141							SW 

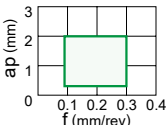
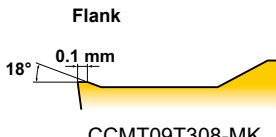

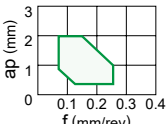
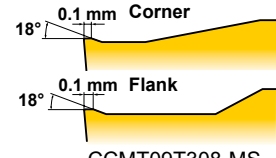

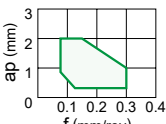
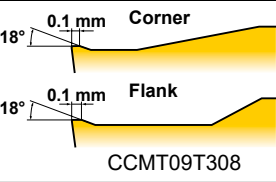
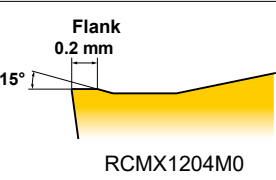

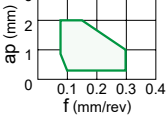
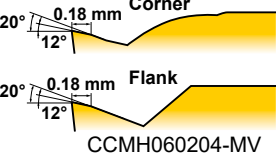

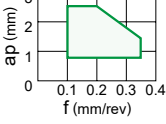
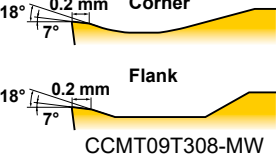



CLASSIFICATION

7° POSITIVE INSERTS WITH HOLE

TURNING INSERTS

A

Application	Tolerance	Breaker Name and Picture	Features		Cross Section Geometry
Light Cutting	G	R/L-SS 	Chipbreaker for light cutting on automatic lathes A parallel chipbreaker. Excellent chip control at low feed rates.	Carbon Steel • Alloy Steel 	Flank 14°  CCGT09T302R-SS
		MP 	First recommendation for medium cutting of carbon, alloy and mild steels Good balance of wear resistance and fracture resistance because of the flat land cutting edge. A wide chip pocket controls increasing of the cutting resistance and reduces vibration and chip jamming even at large depth of cut.	Carbon Steel • Alloy Steel 	0.1 mm Corner 18° 0.1 mm Flank 18°  CCMT09T308-MP
Medium Cutting	M	MM 	First recommendation for medium cutting of stainless steel Good balance of wear resistance and fracture resistance because of the flat land cutting edge. A wide chip pocket controls increasing of the cutting resistance and reduces vibration and chip jamming even at large depth of cut.	Stainless Steel 	0.1 mm Corner 18° 0.1 mm Flank 18°  CCMT09T308-MM
		MK 	First recommendation for medium cutting of cast iron Optimum balance between sharpness and high edge strength for general use.	Cast Iron 	Flank 0.1 mm 18°  CCMT09T308-MK
		MS 	First recommendation for medium cutting of difficult-to-cut materials Ideal for heat-resistant alloy and titanium alloy and cobalt chrome alloy. A wide chip pocket controls increasing of the cutting resistance and reduces vibration and chip jamming even at large depth of cut.	Difficult-to-Cut Materials 	0.1 mm Corner 18° 0.1 mm Flank 18°  CCMT09T308-MS
		Standard 	Alternative chipbreaker for medium cutting of carbon, alloy, mild and stainless steels, and cast iron Balance of edge strength and sharpness due to a combination of a flat land and large rake angle.	Carbon Steel • Alloy Steel 	0.1 mm Corner 18° 0.1 mm Flank 18°  CCMT09T308 Flank 0.2 mm 15°  RCMX1204M0
		MV 	Alternative chipbreaker for medium cutting of carbon, alloy, mild and stainless steels A positive insert and the large rake angle achieve sharp cutting edge performance. The double breakers and round shape in the rake face achieve a wide range of chip discharge.	Carbon Steel • Alloy Steel 	0.18 mm Corner 20° 12° 0.18 mm Flank 20° 12°  CCMH060204-MV
		MW 	Wiper insert for medium cutting of carbon, alloy, mild and stainless steels The wiper allows up to double the feed rate. A wide chip pocket prevents chip jamming.	Carbon Steel • Alloy Steel 	0.2 mm Corner 18° 7° 0.2 mm Flank 18° 7°  CCMT09T308-MW











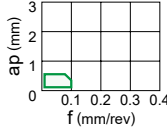

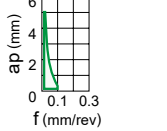
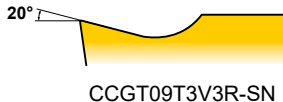
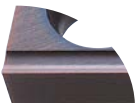
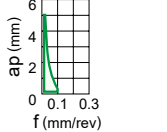
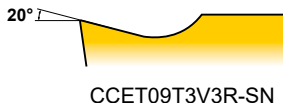
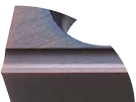
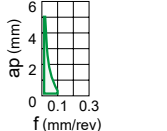
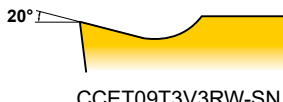
	Rhombic 80° 	Rhombic 55° 	Square 90° 	Triangular 60° 	Rhombic 35° 	Trigon 80° 	Round 	Breaker Name and Cross Section
	CCGT_R/L-SS  ↻ A142	DCGT_R/L-SS  ↻ A149						R/L-SS 
	CCMT_MP  ↻ A142	DCMT_MP  ↻ A149	SCMT_MP  ↻ A155	TCMT_MP  ↻ A159	VCMT_MP  ↻ A168			MP 
	CCMT_MM  ↻ A142	DCMT_MM  ↻ A149	SCMT_MM  ↻ A155	TCMT_MM  ↻ A159	VCMT_MM  ↻ A168			MM 
	CCMT_MK  ↻ A143	DCMT_MK  ↻ A150	SCMT_MK  ↻ A156	TCMT_MK  ↻ A159	VCMT_MK  ↻ A169			MK 
	CCMT_MS  ↻ A143	DCMT_MS  ↻ A150	<small>NEW</small> SCMT_MS  ↻ A156	<small>NEW</small> TCMT_MS  ↻ A159	VCMT_MS  ↻ A169			MS 
	CCMT  ↻ A143	DCMT  ↻ A150	SCMT  ↻ A156	TCMT  ↻ A160	VCMT  ↻ A169	WCMT  ↻ A173	RCMT  ↻ A154	Standard 
							RCMX  ↻ A154	
	CCMH_MV  ↻ A143	DCMT_MV  ↻ A150			VCMT_MV  ↻ A169			MV 
	CCMT_MW  ↻ A143							MW 

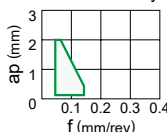

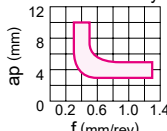
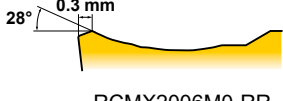

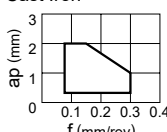
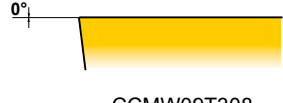

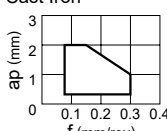

























CLASSIFICATION

7° POSITIVE INSERTS WITH HOLE

TURNING INSERTS

A

Application	Tolerance	Breaker Name and Picture	Features		Cross Section Geometry
Medium Cutting	E	R/L-SR 	Medium cutting on automatic lathes A wide lead chipbreaker. Insert designed for low resistance chip control.	Carbon Steel • Alloy Steel 	Flank 30°  CCET09T3V3R-SR
	G	R/L-SN 	Medium cutting on automatic lathes A parallel chipbreaker. Excellent chip control at low to medium feed rates.	Carbon Steel • Alloy Steel 	Flank 20°  CCGT09T3V3R-SN
	E	R/L-SN 	Medium cutting on automatic lathes A parallel chipbreaker. Excellent chip control at low to medium feed rates. Suitable for precise machining with E class tolerance.	Carbon Steel • Alloy Steel 	Flank 20°  CCET09T3V3R-SN
		R/LW-SN 	Medium cutting on automatic lathes A parallel chipbreaker. Excellent chip control at low to medium feed rates. The wiper produces a good surface finish.	Carbon Steel • Alloy Steel 	Flank 20°  CCET09T3V3RW-SN
	G	SMG 	Medium cutting on automatic lathes 3D moulded chipbreaker provides good chip control. G class insert gives sharp cutting action, allowing high precision machining. Breaker geometry appropriate for copying and back turning.	Carbon Steel • Alloy Steel 	Corner 14° Flank 9°  CCGT09T304M-SMG
Heavy Cutting	M	RR 	Heavy cutting of carbon and alloy steels A wide groove chipbreaker prevents chips from jamming at large depths of cut. Small dimples improve chip control at small depths of cut.	Carbon Steel • Alloy Steel 	28° 0.3 mm  RCMX2006M0-RR
For Cast Iron	M	Flat Top 	Rough cutting of cast iron Flat top. Most effective for unstable machining due to its high edge strength.	Cast Iron 	0°  CCMW09T308
	G	Flat Top 	Chipbreaker for heavy cutting of cast iron Flat top. Most effective for unstable machining due to its high edge strength. Can be used on workpieces requiring close tolerances due to G class insert tolerance.	Cast Iron 	0°  CCGW09T300









	Rhombic 80° 	Rhombic 55° 	Square 90° 	Triangular 60° 	Rhombic 35° 	Trigon 80° 	Round 	Breaker Name and Cross Section
	CCET_R/L-SR  ↻ A143	DCET_R/L-SR  ↻ A150						R/L-SR 
	CCGT_R/L-SN  ↻ A144	DCGT_R/L-SN  ↻ A151						R/L-SN(G) 
	CCET_R/L-SN  ↻ A145	DCET_R/L-SN  ↻ A151						R/L-SN(E) 
	CCET_R/LW-SN  ↻ A145	DCET_R/LW-SN  ↻ A152						R/LW-SN 
	CCGT_SMG  ↻ A145	DCGT_SMG  ↻ A152						SMG 
							RCMX_RR  ↻ A154	RR 
	CCMW  ↻ A145	DCMW  ↻ A152	SCMW  ↻ A156	TCMW  ↻ A160	VCMW  ↻ A169			Flat Top(M) 
	CCGW  ↻ A145	DCGW  ↻ A152						Flat Top(G) 

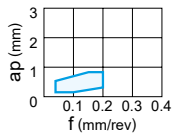
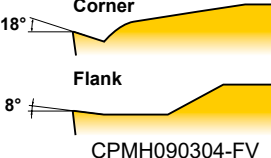
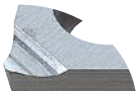
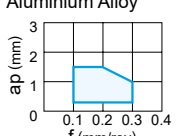
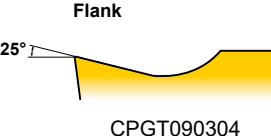
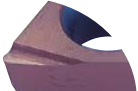
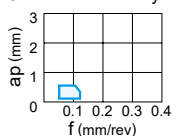
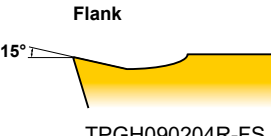

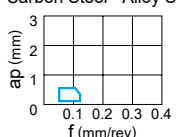
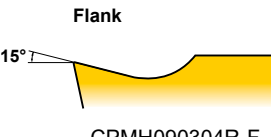

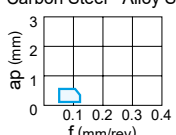
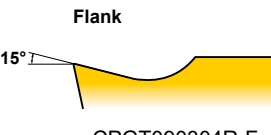

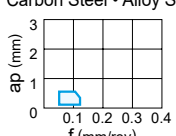
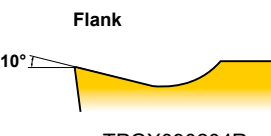
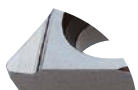
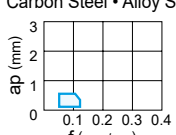
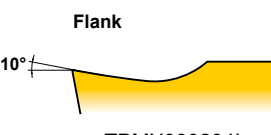
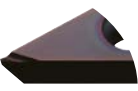
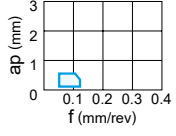
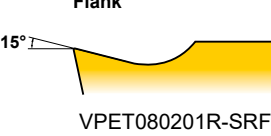

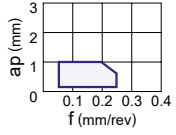
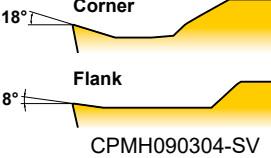





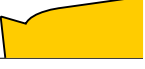







CLASSIFICATION

11° POSITIVE INSERTS WITH HOLE

TURNING INSERTS

A

Application	Tolerance	Breaker Name and Picture	Features		Cross Section Geometry	
Finish Cutting	M	FV 	First recommendation for finish cutting of carbon, alloy, mild and stainless steels Suitable for low depths of cut and low feed rates. Sharp cutting edge and low resistance design achieves excellent cutting performance.	Carbon Steel • Alloy Steel 	 18° Corner 8° Flank CPMH090304-FV	
		Standard 	Finishing Lead chipbreaker controls chip flow. Good chip control for low to medium feed rates.	Aluminium Alloy 	 25° Flank CPGT090304	
		R/L-FS 	Chipbreaker for finish cutting of carbon, alloy and stainless steels, cast iron and aluminium alloy Small wide lead chipbreaker. Sharp cutting edge gives a good surface finish.	Carbon Steel • Alloy Steel 	 15° Flank TPGH090204R-FS	
	G	M	R/L-F 	Finishing Lead chipbreaker controls chip flow. Sharp cutting edge gives a good surface finish.	Carbon Steel • Alloy Steel 	 15° Flank CPMH090304R-F
			R/L-F 	Finishing Lead chipbreaker controls chip flow. Sharp cutting edge gives a good surface finish.	Carbon Steel • Alloy Steel 	 15° Flank CPGT090304R-F
		G	R/L 	Finishing Lead chipbreaker controls chip flow. Good chip control for low to medium feed rates.	Carbon Steel • Alloy Steel 	 10° Flank TPGX090204R
			L 	Finishing Lead chipbreaker controls chip flow. Good chip control for low to medium feed rates.	Carbon Steel • Alloy Steel 	 10° Flank TPMX090204L
	E	SRF 	Finishing Lead chipbreaker controls chip flow. Sharp cutting edge gives a good surface finish.	Carbon Steel • Alloy Steel 	 15° Flank VPET080201R-SRF	
	Light Cutting	M	SV 	First recommendation for light cutting of carbon, alloy, mild and stainless steels, and cast iron Large rake angle provides sharp cutting action. A peninsular dot ensures chip control at depths of cut under 1mm.	Carbon Steel • Alloy Steel 	 18° Corner 8° Flank CPMH090304-SV







	Rhombic 80° 	Rhombic 55° 	Square 90° 	Triangular 60° 	Rhombic 35° 	Trigon 80° 	Round 	Breaker Name and Cross Section
	CPMH_FV  → A146			TPMH_FV  → A162				FV 
	CPGT  → A146							Standard 
				TPGH_R/L-FS  → A162		WPGT_R/L-FS  → A174		R/L-FS 
	CPMH_R/L-F  → A146							R/L-F(M) 
	CPGT_R/L-F  → A146							R/L-F(G) 
				TPGX_R/L  → A162				R/L 
				TPMX_L  → A163				L 
					VPET_R/L-SRF  → A171			SRF 
	CPMH_SV  → A146			TPMH_SV  → A163				SV 

CLASSIFICATION

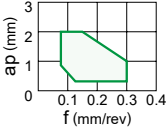
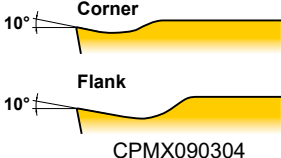
11° POSITIVE INSERTS WITH HOLE

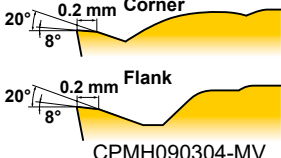

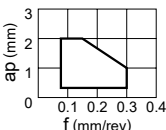
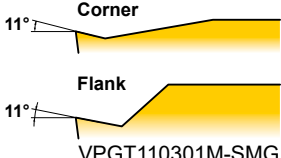





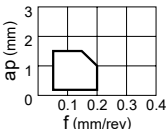

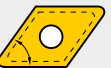









TURNING INSERTS



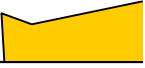





A

Application	Tolerance	Breaker Name and Picture	Features	Cross Section Geometry
Medium Cutting	M	Standard 	Alternative chipbreaker for medium cutting of carbon, alloy and stainless steels Standard, general purpose chipbreaker.	Carbon Steel • Alloy Steel  10° Corner 10° Flank CPMX090304
	M	MV 	First recommendation for medium cutting of carbon, alloy, mild and stainless steels, and cast iron A positive insert and large rake angle achieves sharp cutting edge performance. Double breakers in the rake face achieve a wide range of chip discharge.	Carbon Steel • Alloy Steel  20° 0.2 mm Corner 8° 20° 0.2 mm Flank 8° CPMH090304-MV
	G	SMG 	Medium cutting on automatic lathes 3D moulded chipbreaker provides good chip control. G class insert gives sharp cutting action, allowing high precision machining. Breaker geometry appropriate for copying and back turning.	Carbon Steel • Alloy Steel  11° Corner 11° Flank VPGT110301M-SMG
For Cast Iron	M	Flat Top 	Rough cutting of cast iron Most effective for unstable machining due to its high edge strength.	Cast Iron  0° SPMW120308
	G	Flat Top 	Chipbreaker for heavy cutting of cast iron Most effective for unstable machining due to its high edge strength. Can be used on workpieces requiring close tolerances due to G class insert tolerance.	Cast Iron  0° SPGX120308

15° POSITIVE INSERTS WITH HOLE

Application	Tolerance	Breaker Name and Picture	Features	Cross Section Geometry
For Aluminium Alloy	G	R/L 	For aluminium alloy cutting Lead chipbreaker. Sharp cutting edge gives a good surface finish.	Aluminium Alloy  25° Flank VDGX160302R

	Rhombic 80° 	Rhombic 55° 	Square 90° 	Triangular 60° 	Rhombic 35° 	Trigon 80° 	Round 	Breaker Name and Cross Section
	CPMX  ↻ A146		SPMT  ↻ A157	TPMX  ↻ A163				Standard 
	CPMH_MV  ↻ A146			TPMH_MV  ↻ A163		WPMT_MV  ↻ A174		MV 
					VPGT_SMG  ↻ A171			SMG 
			SPMW  ↻ A157					Flat Top(M) 
			SPGX  ↻ A157	TPGX  ↻ A163				Flat Top(G) 

	Rhombic 80° 	Rhombic 55° 	Square 90° 	Triangular 60° 	Rhombic 35° 	Trigon 80° 	Round 	Breaker Name and Cross Section
					VDGX_R/L  ↻ A170			R/L 





CLASSIFICATION

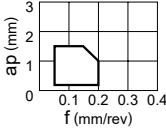
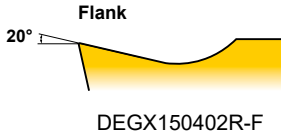
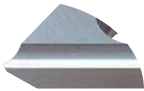
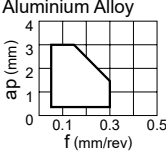
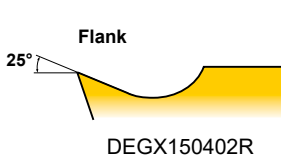



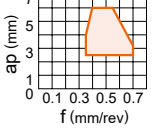
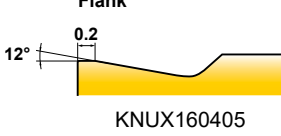

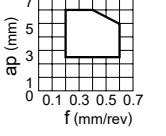
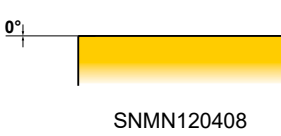

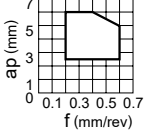
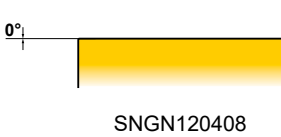

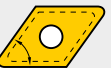
20° POSITIVE INSERTS WITH HOLE





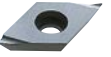







TURNING INSERTS
A

Application	Tolerance	Breaker Name and Picture	Features		Cross Section Geometry
For Aluminium Alloy	G	R/L-F 	For aluminium alloy cutting Lead chipbreaker. Sharp cutting edge gives a good surface finish.	Aluminium Alloy 	 Flank 20° DEG150402R-F
		R/L 	For aluminium alloy cutting A parallel chipbreaker. Sharp cutting edge gives a good surface finish. Good chip control for medium feed rates.	Aluminium Alloy 	 Flank 25° DEG150402R

NEGATIVE INSERTS WITHOUT HOLE



Application	Tolerance	Breaker Name and Picture	Features		Cross Section Geometry
Rough Cutting	M	R/L-M1/2 	Rough cutting of carbon and alloy steels Single sided chipbreaker. Can be used for copying. An angled chipbreaker for controlling chip flow.	Carbon Steel • Alloy Steel 	 Flank 12° 0.2 KNUX160405
For Cast Iron	M	Flat Top 	Rough cutting of cast iron Flat top. Most effective for unstable machining due to high edge strength and stable insert clamping.	Cast Iron 	 0° SNMN120408
	G	Flat Top 	Chipbreaker for heavy cutting of cast iron Flat top. Most effective for unstable machining due to high edge strength and stable insert clamping. Can be used on workpieces requiring close tolerances due to G class insert tolerance.	Cast Iron 	 0° SNGN120408

	Rhombic 80° 	Rhombic 55° 	Square 90° 	Triangular 60° 	Rhombic 35° 	Trigon 80° 	Round 	Breaker Name and Cross Section
		DEGX_R/L-F  ↻ A153						R/L-F 
		DEGX_R/L  ↻ A153		TEGX_R/L  ↻ A161				R/L 





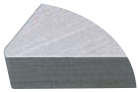
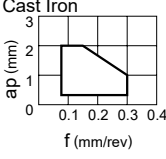



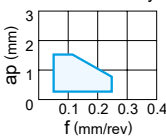
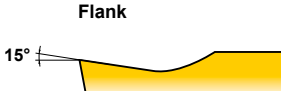

	Rhombic 80° 	Square 90° 	Triangular 60° 	Parallelogram 55° 	Breaker Name and Cross Section
				KNUX_R/L-M1/2  ↻ A135	R/L-M1/2 
	CNMN  ↻ A136	SNMN  ↻ A137	TNMN  ↻ A138		Flat Top(M) 
		SNGN  ↻ A137	TNGN  ↻ A138		Flat Top(G) 

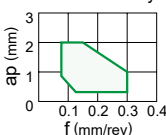
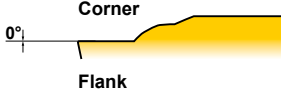
CLASSIFICATION

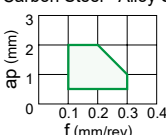
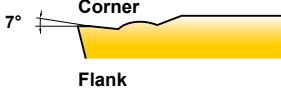
7° POSITIVE INSERTS WITHOUT HOLE

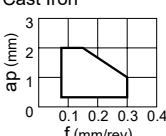

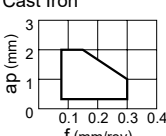
Application	Tolerance	Breaker Name and Picture	Features	Cross Section Geometry
For Cast Iron	G	Flat Top 	Chipbreaker for heavy cutting of cast iron Flat top. Most effective for unstable machining due to high edge strength and stable insert clamping. Use on workpieces requiring close tolerance inserts.	Cast Iron   TNGN160408



















11° POSITIVE INSERTS WITHOUT HOLE

Application	Tolerance	Breaker Name and Picture	Features	Cross Section Geometry
Finish Cutting	G	R/L 	Finishing A parallel chipbreaker. Good chip control for low to medium feed rates.	Carbon Steel • Alloy Steel   SPGR090304R
		Standard 	Light to medium cutting of carbon, alloy and stainless steels Standard, general purpose chipbreaker.	Carbon Steel • Alloy Steel   SPMR090308
Light to Medium Cutting	M	80 	Light to medium cutting of carbon steel, alloy steel and stainless steel Large chip pocket for excellent chip evacuation. Double breakers in the rake face achieves a wide range of chip breaking.	Carbon Steel • Alloy Steel   SPMR120308
		Flat Top 	Rough cutting of cast iron Most effective for unstable machining due to high edge strength and stable insert clamping.	Cast Iron   SPMN090308
For Cast Iron	G	Flat Top 	Chipbreaker for heavy cutting of cast iron Most effective for unstable machining due to high edge strength and stable insert clamping. Can be used on workpieces requiring close tolerances due to G class insert tolerance.	Cast Iron   SPGN090308

TURNING INSERTS

A

Triangular 60° 	Breaker Name and Cross Section
TCGN  ↻ A179	Flat Top 

Square 90° 	Triangular 60° 	Round 	Breaker Name and Cross Section
SPGR_R  ↻ A177	TPGR_R/L  ↻ A180		R/L 
SPMR  ↻ A177	TPMR  ↻ A180		Standard 
SPMR-80  ↻ A177	TPMR-80  ↻ A180		80 
SPMN  ↻ A177	TPMN  ↻ A180		Flat Top(M) 
SPGN  ↻ A178	TPGN  ↻ A181		Flat Top(G) 

SPECIAL PURPOSE INSERTS

Application	Tolerance	Tool Holder Type	Inserts
Special	G	TL Type	RTG  ↻ A176

TURNING INSERTS

RECOMMENDED CUTTING CONDITIONS

NEGATIVE INSERTS

Breaker : Std : Standard Flat : Flat Top

Work Material	Hardness	Cutting Mode		Priority	Breaker	Grade	Cutting Speed (m/min)	Feed (mm/rev)	Depth of Cut (mm)
		Symbol	Code						
Mild Steel (St37-2, Ck10)	≤180HB	●	F	1	FY	VP25N	285-450	0.09-0.23	0.20-0.80
		●	F	2	FY	NX2525	270-385	0.09-0.23	0.20-0.80
		●	F	3	FS	NX2525	270-385	0.09-0.23	0.20-0.70
		●	L	1	SY	VP25N	260-410	0.16-0.33	0.50-1.20
		●	L	2	SY	NX2525	245-350	0.16-0.33	0.50-1.20
		●	F	1	FY	MP3025	275-425	0.09-0.23	0.20-0.80
		●	F	2	FY	NX3035	260-370	0.09-0.23	0.20-0.80
		●	F	3	FS	NX2525	270-385	0.09-0.23	0.20-0.70
		●	L	1	SY	MP3025	255-385	0.16-0.33	0.50-1.20
		●	L	2	SY	NX3035	240-340	0.16-0.33	0.50-1.20
		✚	F	1	FY	UE6020	285-465	0.09-0.23	0.20-0.80
		✚	L	1	SY	UE6020	260-425	0.16-0.33	0.50-1.20
Carbon Steel • Alloy Steel (Ck45, 42CrMo4)	180 280HB	●	F	1	FP	NX2525	210-300	0.08-0.25	0.10-1.00
		●	F	2	FH	AP25N	220-345	0.08-0.20	0.20-1.00
		●	F	3	FH	NX2525	210-300	0.08-0.20	0.20-1.00
		●	F	4	R/L-F	MP3025	215-330	0.05-0.15	0.10-0.50
		●	F	5	PK	NX2525	200-285	0.10-0.30	0.20-1.00
		●	L	1	LP	MC6115	250-480	0.10-0.40	0.30-2.00
		●	L	2	LP	MC6125	275-425	0.10-0.40	0.30-2.00
		●	L	3	LP	MC6015	210-360	0.10-0.40	0.30-2.00
		●	L	4	LP	UE6105	225-410	0.10-0.40	0.30-2.00
		●	L	5	SH	MC6115	250-480	0.10-0.40	0.30-2.00
		●	L	6	SH	MC6125	275-425	0.10-0.40	0.30-2.00
		●	L	7	SH	UE6105	225-410	0.10-0.40	0.30-2.00
		●	L	8	LP	MP3025	195-300	0.10-0.40	0.30-2.00
		●	L	9	SH	AP25N	200-315	0.10-0.40	0.30-2.00
		●	L	10	SH	NX2525	190-275	0.10-0.40	0.30-2.00
		●	L	11	SA	MC6115	250-480	0.10-0.40	0.30-2.00
		●	L	12	SA	MC6125	275-425	0.10-0.40	0.30-2.00
		●	L	13	SA	UE6105	225-410	0.10-0.40	0.30-2.00
		●	L	14	SA	NX2525	190-275	0.10-0.40	0.30-2.00
		●	L	15	SW	MC6115	250-480	0.10-0.50	0.30-2.50
		●	L	16	SW	MC6125	275-425	0.10-0.50	0.30-2.50
		●	L	17	SW	UE6105	225-410	0.10-0.50	0.30-2.50
		●	L	18	SW	MP3025	195-300	0.10-0.50	0.30-2.50
		●	L	19	SW	NX2525	190-275	0.10-0.50	0.30-2.50
		●	L	20	R/L-K	MP3025	195-300	0.08-0.20	0.30-1.20
		●	M	1	MP	MC6115	230-440	0.16-0.50	0.30-4.00
		●	M	2	MP	MC6125	250-390	0.16-0.50	0.30-4.00
		●	M	3	MP	MC6015	195-330	0.16-0.50	0.30-4.00
		●	M	4	MP	UE6105	205-375	0.16-0.50	0.30-4.00
		●	M	5	MP	MP3025	180-275	0.16-0.50	0.30-4.00
		●	M	6	MA	MC6115	230-440	0.20-0.50	0.30-4.00
●	M	7	MA	MC6125	250-390	0.20-0.50	0.30-4.00		
●	M	8	MA	UE6105	205-375	0.20-0.50	0.30-4.00		
●	M	9	MH	UE6105	205-375	0.20-0.55	1.00-4.00		
●	M	10	Std	MC6115	230-440	0.25-0.60	1.50-5.00		
●	M	11	Std	MC6125	250-390	0.25-0.60	1.50-5.00		

CUTTING CONDITIONS : ● : Stable Cutting ● : General Cutting ✚ : Unstable Cutting

CUTTING AREA : F : Finish Cutting L : Light Cutting M : Medium Cutting R : Rough Cutting H : Heavy Cutting

Work Material	Hardness	Cutting Mode	Priority	Breaker	Grade	Cutting Speed (m/min)	Feed (mm/rev)	Depth of Cut (mm)		
P	Carbon Steel • Alloy Steel (Ck45, 42CrMo4)	180 280HB	●	M	12	Std	UE6105	205–375	0.25–0.60	1.50–5.00
			●	M	13	Std	MP3025	180–275	0.25–0.60	1.50–5.00
			●	M	14	Std	NX2525	175–250	0.25–0.60	1.50–5.00
			●	M	15	Std	UTi20T	90–130	0.25–0.60	1.50–5.00
			●	M	16	MW	MC6115	230–440	0.20–0.60	0.90–4.00
			●	M	17	MW	MC6125	250–390	0.20–0.60	0.90–4.00
			●	M	18	MW	UE6105	205–375	0.20–0.60	0.90–4.00
			●	M	19	R/L	MP3025	180–275	0.15–0.32	0.40–2.00
			●	R	1	RP	MC6115	215–415	0.25–0.60	1.50–6.00
			●	R	2	RP	MC6125	235–370	0.25–0.60	1.50–6.00
			●	R	3	RP	MC6015	185–310	0.25–0.60	1.50–6.00
			●	R	4	RP	UE6105	190–355	0.25–0.60	1.50–6.00
			●	R	5	GH	MC6115	215–415	0.25–0.60	1.50–6.00
			●	R	6	GH	MC6125	235–370	0.25–0.60	1.50–6.00
			●	R	7	GH	UE6105	190–355	0.25–0.60	1.50–6.00
			●	H	1	HX	MC6025	165–265	0.50–1.26	3.00–11.00
			●	H	2	HX	UE6110	165–280	0.50–1.26	3.00–11.00
			●	H	3	HV	MC6025	135–220	0.70–1.30	4.00–12.00
			●	H	4	HV	UE6110	135–230	0.70–1.30	4.00–12.00
			●	H	5	HZ	MC6025	165–265	0.40–1.20	2.00–10.00
			●	H	6	HZ	UE6110	165–280	0.40–1.20	2.00–10.00
			●	H	7	HL	MC6025	165–265	0.40–1.00	1.50–8.00
			●	H	8	HL	UE6110	165–280	0.40–1.00	1.50–8.00
			●	H	9	HM	MC6025	165–265	0.50–1.10	2.00–10.00
			●	H	10	HM	UE6110	165–280	0.50–1.10	2.00–10.00
			●	F	1	FP	MP3025	215–330	0.08–0.25	0.10–1.00
			●	F	2	FH	MP3025	215–330	0.08–0.20	0.20–1.00
			●	F	3	FH	NX3035	200–285	0.08–0.20	0.20–1.00
			●	F	4	FH	UE6110	230–395	0.08–0.20	0.20–1.00
			●	L	1	LP	MC6115	250–480	0.10–0.40	0.30–2.00
			●	L	2	LP	MC6125	275–425	0.10–0.40	0.30–2.00
			●	L	3	LP	MC6015	210–360	0.10–0.40	0.30–2.00
			●	L	4	SH	MC6115	250–480	0.10–0.40	0.30–2.00
			●	L	5	SH	MC6125	275–425	0.10–0.40	0.30–2.00
			●	L	6	SH	MC6015	210–360	0.10–0.40	0.30–2.00
			●	L	7	SA	MC6115	250–480	0.10–0.40	0.30–2.00
			●	L	8	SA	MC6125	275–425	0.10–0.40	0.30–2.00
			●	L	9	SA	MC6015	210–360	0.10–0.40	0.30–2.00
			●	L	10	LP	UE6110	210–360	0.10–0.40	0.30–2.00
			●	L	11	SH	UE6110	210–360	0.10–0.40	0.30–2.00
●	L	12	SA	UE6110	210–360	0.10–0.40	0.30–2.00			
●	L	13	LP	MP3025	195–300	0.10–0.40	0.30–2.00			
●	L	14	SH	NX3035	185–260	0.10–0.40	0.30–2.00			
●	L	15	SA	NX3035	185–260	0.10–0.40	0.30–2.00			
●	L	16	SW	MC6115	250–480	0.10–0.50	0.30–2.50			
●	L	17	SW	MC6125	275–425	0.10–0.50	0.30–2.50			
●	L	18	SW	MC6015	210–360	0.10–0.50	0.30–2.50			
●	L	19	SW	UE6110	210–360	0.10–0.50	0.30–2.50			

A

TURNING INSERTS

TURNING INSERTS

RECOMMENDED CUTTING CONDITIONS

NEGATIVE INSERTS

Breaker : Std : Standard Flat : Flat Top

Work Material	Hardness	Cutting Mode	Priority	Breaker	Grade	Cutting Speed (m/min)	Feed (mm/rev)	Depth of Cut (mm)	
P Carbon Steel • Alloy Steel (Ck45, 42CrMo4)	180 280HB	●	L	20	SW	NX3035	185–260	0.30–2.50	
		●	M	1	MP	MC6125	250–390	0.30–4.00	
		●	M	2	MP	MC6115	230–440	0.30–4.00	
		●	M	3	MP	MC6015	195–330	0.30–4.00	
		●	M	4	MA	MC6125	250–390	0.20–0.50	0.30–4.00
		●	M	5	MA	MC6115	230–440	0.20–0.50	0.30–4.00
		●	M	6	MA	MC6015	195–330	0.20–0.50	0.30–4.00
		●	M	7	MH	MC6125	250–390	0.20–0.55	1.00–4.00
		●	M	8	MH	MC6115	230–440	0.20–0.55	1.00–4.00
		●	M	9	MH	MC6015	195–330	0.20–0.55	1.00–4.00
		●	M	10	Std	MC6125	250–390	0.25–0.60	1.50–5.00
		●	M	11	Std	MC6115	230–440	0.25–0.60	1.50–5.00
		●	M	12	Std	MC6015	195–330	0.25–0.60	1.50–5.00
		●	M	13	MP	UE6110	195–330	0.16–0.50	0.30–4.00
		●	M	14	MA	UE6110	195–330	0.20–0.50	0.30–4.00
		●	M	15	MA	NX3035	170–240	0.20–0.50	0.30–4.00
		●	M	16	MH	UE6110	195–330	0.20–0.55	1.00–4.00
		●	M	17	Std	UE6110	195–330	0.25–0.60	1.50–5.00
		●	M	18	Std	NX3035	170–240	0.25–0.60	1.50–5.00
		●	M	19	MW	MC6125	250–390	0.20–0.60	0.90–4.00
		●	M	20	MW	MC6115	230–440	0.20–0.60	0.90–4.00
		●	M	21	MW	MC6015	195–330	0.20–0.60	0.90–4.00
		●	M	22	MW	UE6110	195–330	0.20–0.60	0.90–4.00
		●	R	1	RP	MC6125	235–370	0.25–0.60	1.50–6.00
		●	R	2	RP	MC6115	215–415	0.25–0.60	1.50–6.00
		●	R	3	RP	MC6015	185–310	0.25–0.60	1.50–6.00
		●	R	4	RP	UE6110	185–310	0.25–0.60	1.50–6.00
		●	R	5	GH	MC6125	235–370	0.25–0.60	1.50–6.00
		●	R	6	GH	MC6115	215–415	0.25–0.60	1.50–6.00
		●	R	7	GH	UE6110	185–310	0.25–0.60	1.50–6.00
		●	H	1	HX	MC6025	165–265	0.50–1.26	3.00–11.00
		●	H	2	HV	MC6025	135–220	0.70–1.30	4.00–12.00
		●	H	3	HZ	MC6025	165–265	0.40–1.20	2.00–10.00
		●	H	4	HL	MC6025	165–265	0.40–1.00	1.50–8.00
		●	H	5	HM	MC6025	165–265	0.50–1.10	2.00–10.00
		●	H	6	HR	MC6025	135–220	0.70–1.30	3.00–12.00
		●	H	7	HZ	UE6110	165–280	0.40–1.20	2.00–10.00
		✦	F	1	FP	MC6025	230–375	0.08–0.25	0.10–1.00
		✦	F	2	FP	MC6015	230–395	0.08–0.25	0.10–1.00
		✦	F	3	FH	UE6110	230–395	0.08–0.20	0.20–1.00
		✦	L	1	LP	MC6125	275–425	0.10–0.40	0.30–2.00
		✦	L	2	LP	MC6025	210–345	0.10–0.40	0.30–2.00
✦	L	3	LP	MC6035	185–260	0.10–0.40	0.30–2.00		
✦	L	4	SH	MC6125	275–425	0.10–0.40	0.30–2.00		
✦	L	5	SH	MC6025	210–345	0.10–0.40	0.30–2.00		
✦	L	6	SA	MC6125	275–425	0.10–0.40	0.30–2.00		
✦	L	7	SA	MC6025	210–345	0.10–0.40	0.30–2.00		
✦	L	8	SA	UE6020	200–330	0.10–0.40	0.30–2.00		

CUTTING CONDITIONS : ● : Stable Cutting ● : General Cutting ✦ : Unstable Cutting

CUTTING AREA : F : Finish Cutting L : Light Cutting M : Medium Cutting R : Rough Cutting H : Heavy Cutting

Work Material	Hardness	Cutting Mode	Priority	Breaker	Grade	Cutting Speed (m/min)	Feed (mm/rev)	Depth of Cut (mm)	
P Carbon Steel • Alloy Steel (Ck45, 42CrMo4)	180 280HB	✚	M	1	MP	MC6125	250–390	0.16–0.50	0.30–4.00
		✚	M	2	MP	MC6025	195–315	0.16–0.50	0.30–4.00
		✚	M	3	MP	MC6035	170–240	0.16–0.50	0.30–4.00
		✚	M	4	MA	MC6125	250–390	0.20–0.50	0.30–4.00
		✚	M	5	MA	MC6025	195–315	0.20–0.50	0.30–4.00
		✚	M	6	MA	MC6035	170–240	0.20–0.50	0.30–4.00
		✚	M	7	MH	MC6125	250–390	0.20–0.55	1.00–4.00
		✚	M	8	MH	MC6025	195–315	0.20–0.55	1.00–4.00
		✚	M	9	MH	MC6035	170–240	0.20–0.55	1.00–4.00
		✚	M	10	Std	MC6125	250–390	0.25–0.60	1.50–5.00
		✚	M	11	Std	MC6025	195–315	0.25–0.60	1.50–5.00
		✚	M	12	Std	MC6035	170–240	0.25–0.60	1.50–5.00
		✚	M	13	MW	MC6125	250–390	0.20–0.60	0.90–4.00
		✚	M	14	MW	MC6025	195–315	0.20–0.60	0.90–4.00
		✚	R	1	RP	MC6125	235–370	0.25–0.60	1.50–6.00
		✚	R	2	RP	MC6025	185–295	0.25–0.60	1.50–6.00
		✚	R	3	RP	MC6035	160–225	0.25–0.60	1.50–6.00
		✚	R	4	GH	MC6125	235–370	0.25–0.60	1.50–6.00
		✚	H	1	HX	MC6035	140–200	0.50–1.26	3.00–11.00
		✚	H	2	HX	UH6400	140–195	0.50–1.26	3.00–11.00
		✚	H	3	HV	MC6035	115–165	0.70–1.30	4.00–12.00
		✚	H	4	HV	UH6400	115–160	0.70–1.30	4.00–12.00
		✚	H	5	HZ	MC6035	140–200	0.40–1.20	2.00–10.00
		✚	H	6	HZ	UH6400	140–195	0.40–1.20	2.00–10.00
		✚	H	7	HL	MC6035	140–200	0.40–1.00	1.50–8.00
		✚	H	8	HM	MC6035	140–200	0.50–1.10	2.00–10.00
		✚	H	9	HR	MC6035	115–165	0.70–1.30	3.00–12.00

A

TURNING INSERTS

TURNING INSERTS

RECOMMENDED CUTTING CONDITIONS

NEGATIVE INSERTS

Breaker : Std : Standard Flat : Flat Top

Work Material	Hardness	Cutting Mode	Priority	Breaker	Grade	Cutting Speed (m/min)	Feed (mm/rev)	Depth of Cut (mm)	
Austenitic Stainless Steel (X5CrNi189, X5CrNiMo1810)	≤200HB	●	L	1	LM	MC7015	180-285	0.10-0.30	0.30-2.00
		●	L	2	SH	US735	95-185	0.10-0.40	0.30-2.00
		●	L	3	SH	NX2525	65-135	0.10-0.40	0.30-2.00
		●	M	1	MM	MC7015	165-260	0.15-0.45	0.70-5.00
		●	M	2	GM	MC7015	165-260	0.16-0.50	0.50-4.00
		●	R	1	RM	MC7015	155-245	0.25-0.55	1.50-6.00
		●	H	1	HL	US735	75-140	0.40-1.00	1.50-8.00
		●	H	2	HL	US735	75-140	0.40-1.00	1.50-8.00
		●	L	1	LM	MC7025	165-220	0.10-0.30	0.30-2.00
		●	L	2	SH	US735	95-185	0.10-0.40	0.30-2.00
		●	M	1	MM	MC7025	150-200	0.15-0.45	0.70-5.00
		●	M	2	GM	MC7025	150-200	0.16-0.50	0.50-4.00
		●	M	3	MA	MC7025	150-200	0.20-0.50	0.30-4.00
		●	M	4	MS	US735	90-170	0.16-0.50	0.50-4.00
		●	M	5	MA	US735	90-170	0.20-0.50	0.30-4.00
		●	R	1	RM	MC7025	140-190	0.25-0.55	1.50-6.00
		●	R	2	GH	US735	85-160	0.25-0.60	1.50-6.00
		●	H	1	HL	US735	75-140	0.40-1.00	1.50-8.00
		●	H	2	HM	US735	75-140	0.50-1.10	2.00-10.00
		●	L	1	LM	MP7035	95-155	0.10-0.30	0.30-2.00
		●	L	2	SH	US735	95-185	0.10-0.40	0.30-2.00
		●	M	1	MM	MP7035	90-145	0.15-0.45	0.70-5.00
		●	M	2	GM	MP7035	90-145	0.16-0.50	0.50-4.00
		●	M	3	MA	MP7035	90-145	0.20-0.50	0.30-4.00
		●	M	4	MS	US735	90-170	0.16-0.50	0.50-4.00
		●	M	5	MS	VP15TF	80-135	0.16-0.50	0.50-4.00
		●	M	6	MS	UP20M	100-150	0.16-0.50	0.50-4.00
		●	M	7	MS	UTi20T	80-115	0.16-0.50	0.50-4.00
		●	M	8	MA	VP15TF	80-135	0.20-0.50	0.30-4.00
		●	M	9	Std	VP15TF	80-135	0.25-0.60	1.50-5.00
		●	R	1	RM	MP7035	85-135	0.25-0.55	1.50-6.00
		●	R	2	GH	US735	85-160	0.25-0.60	1.50-6.00
		●	H	1	HL	US735	75-140	0.40-1.00	1.50-8.00
●	H	2	HM	US735	75-140	0.50-1.10	2.00-10.00		
Austenitic Stainless Steel (X2CrNiN1810, X2CrNiMoN1813)	>200HB	●	L	1	LM	MC7015	150-240	0.10-0.30	0.30-2.00
		●	L	2	SH	US735	80-155	0.10-0.40	0.30-2.00
		●	L	3	SH	NX2525	55-115	0.10-0.40	0.30-2.00
		●	M	1	MM	MC7015	135-215	0.15-0.45	0.70-5.00
		●	M	2	GM	MC7015	135-215	0.16-0.50	0.50-4.00
		●	R	1	RM	MC7015	130-205	0.25-0.55	1.50-6.00
		●	H	1	HL	US735	60-120	0.40-1.00	1.50-8.00
		●	H	2	HM	US735	60-120	0.50-1.10	2.00-10.00
		●	L	1	LM	MC7025	135-180	0.10-0.30	0.30-2.00
		●	L	2	SH	US735	80-155	0.10-0.40	0.30-2.00
		●	M	1	MM	MC7025	125-165	0.15-0.45	0.70-5.00
		●	M	2	GM	MC7025	125-165	0.16-0.50	0.50-4.00
		●	M	3	MA	MC7025	125-165	0.20-0.50	0.30-4.00
		●	M	4	MS	US735	75-140	0.16-0.50	0.50-4.00

CUTTING CONDITIONS : ● : Stable Cutting ● : General Cutting ✦ : Unstable Cutting

CUTTING AREA : F : Finish Cutting L : Light Cutting M : Medium Cutting R : Rough Cutting H : Heavy Cutting

Work Material	Hardness	Cutting Mode	Priority	Breaker	Grade	Cutting Speed (m/min)	Feed (mm/rev)	Depth of Cut (mm)	
Austenitic Stainless Steel (X2CrNiN1810, X2CrNiMoN1813)	>200HB	●	M	5	MA	US735	75—140	0.20—0.50	0.30—4.00
		●	R	1	RM	MC7025	115—155	0.25—0.55	1.50—6.00
		●	R	2	GH	US735	70—135	0.25—0.60	1.50—6.00
		●	H	1	HL	US735	60—120	0.40—1.00	1.50—8.00
		●	H	2	HM	US735	60—120	0.50—1.10	2.00—10.00
		⊕	L	1	LM	MP7035	80—130	0.10—0.30	0.30—2.00
		⊕	L	2	SH	US735	80—155	0.10—0.40	0.30—2.00
		⊕	M	1	MM	MP7035	75—120	0.15—0.45	0.70—5.00
		⊕	M	2	GM	MP7035	75—120	0.16—0.50	0.50—4.00
		⊕	M	3	MA	MP7035	75—120	0.20—0.50	0.30—4.00
		⊕	M	4	MS	US735	75—140	0.16—0.50	0.50—4.00
		⊕	M	5	MS	VP15TF	65—110	0.16—0.50	0.50—4.00
		⊕	M	6	MS	UP20M	80—125	0.16—0.50	0.50—4.00
		⊕	M	7	MS	UTi20T	65—95	0.16—0.50	0.50—4.00
		⊕	M	8	MA	VP15TF	65—110	0.20—0.50	0.30—4.00
		⊕	M	9	Std	VP15TF	65—110	0.25—0.60	1.50—5.00
		⊕	R	1	RM	MP7035	70—115	0.25—0.55	1.50—6.00
		⊕	R	2	GH	US735	70—135	0.25—0.60	1.50—6.00
⊕	H	1	HL	US735	60—120	0.40—1.00	1.50—8.00		
⊕	H	2	HM	US735	60—120	0.50—1.10	2.00—10.00		
M Two-phase Stainless Steel (X3CrNiCu1894)	≤280HB	●	L	1	LM	MC7015	120—190	0.10—0.30	0.30—2.00
		●	L	2	SH	US735	65—125	0.10—0.40	0.30—2.00
		●	L	3	SH	NX2525	40—90	0.10—0.40	0.30—2.00
		●	M	1	MM	MC7015	110—175	0.15—0.45	0.70—5.00
		●	M	2	GM	MC7015	110—175	0.16—0.50	0.50—4.00
		●	R	1	RM	MC7015	105—165	0.25—0.55	1.50—6.00
		●	H	1	HL	US735	50—95	0.40—1.00	1.50—8.00
		●	H	2	HM	US735	50—95	0.50—1.10	2.00—10.00
		●	L	1	LM	MC7025	110—145	0.10—0.30	0.30—2.00
		●	L	2	SH	US735	65—125	0.10—0.40	0.30—2.00
		●	M	1	MM	MC7025	100—135	0.15—0.45	0.70—5.00
		●	M	2	GM	MC7025	100—135	0.16—0.50	0.50—4.00
		●	M	3	MA	MC7025	100—135	0.20—0.50	0.30—4.00
		●	M	4	MS	US735	60—115	0.16—0.50	0.50—4.00
		●	M	5	MA	US735	60—115	0.20—0.50	0.30—4.00
		●	R	1	RM	MC7025	95—125	0.25—0.55	1.50—6.00
		●	R	2	GH	US735	55—105	0.25—0.60	1.50—6.00
		●	H	1	HL	US735	50—95	0.40—1.00	1.50—8.00
		●	H	2	HM	US735	50—95	0.50—1.10	2.00—10.00
		⊕	L	1	LM	MP7035	65—105	0.10—0.30	0.30—2.00
		⊕	L	2	SH	US735	65—125	0.10—0.40	0.30—2.00
		⊕	M	1	MM	MP7035	60—95	0.15—0.45	0.70—5.00
		⊕	M	2	GM	MP7035	60—95	0.16—0.50	0.50—4.00
		⊕	M	3	MA	MP7035	60—95	0.20—0.50	0.30—4.00
		⊕	M	4	MS	US735	60—115	0.16—0.50	0.50—4.00
		⊕	M	5	MS	VP15TF	50—90	0.16—0.50	0.50—4.00
		⊕	M	6	MS	UP20M	65—100	0.16—0.50	0.50—4.00
		⊕	M	7	MS	UTi20T	50—75	0.16—0.50	0.50—4.00

TURNING INSERTS

RECOMMENDED CUTTING CONDITIONS

NEGATIVE INSERTS

Breaker : Std : Standard Flat : Flat Top

Work Material	Hardness	Cutting Mode	Priority	Breaker	Grade	Cutting Speed (m/min)	Feed (mm/rev)	Depth of Cut (mm)	
Two-phase Stainless Steel (X3CrNiCu1894)	≤280HB	✚	M	8	MA	VP15TF	50-90	0.20-0.50	0.30-4.00
		✚	M	9	Std	VP15TF	50-90	0.25-0.60	1.50-5.00
		✚	R	1	RM	MP7035	55-90	0.25-0.55	1.50-6.00
		✚	R	2	GH	US735	55-105	0.25-0.60	1.50-6.00
		✚	H	1	HL	US735	50-95	0.40-1.00	1.50-8.00
		✚	H	2	HM	US735	50-95	0.50-1.10	2.00-10.00
Ferritic and Martensitic Stainless Steel (X10Cr13, X8Cr17)	≤200HB	●	L	1	LM	MC7015	180-285	0.10-0.30	0.30-2.00
		●	L	2	SH	US735	95-185	0.10-0.40	0.30-2.00
		●	L	3	SH	NX2525	65-135	0.10-0.40	0.30-2.00
		●	M	1	MM	MC7015	165-260	0.15-0.45	0.70-5.00
		●	M	2	GM	MC7015	165-260	0.16-0.50	0.50-4.00
		●	R	1	RM	MC7015	155-245	0.25-0.55	1.50-6.00
		●	H	1	HL	US735	75-140	0.40-1.00	1.50-8.00
		●	H	2	HM	US735	75-140	0.50-1.10	2.00-10.00
		●	L	1	LM	MC7025	165-220	0.10-0.30	0.30-2.00
		●	L	2	SH	US735	95-185	0.10-0.40	0.30-2.00
		●	M	1	MM	MC7025	150-200	0.15-0.45	0.70-5.00
		●	M	2	GM	MC7025	150-200	0.16-0.50	0.50-4.00
		●	M	3	MA	MC7025	150-200	0.20-0.50	0.30-4.00
		●	M	4	MA	US735	90-170	0.20-0.50	0.30-4.00
		●	M	5	MS	US735	90-170	0.16-0.50	0.50-4.00
		●	R	1	RM	MC7025	140-190	0.25-0.55	1.50-6.00
		●	R	2	GH	US735	85-160	0.25-0.60	1.50-6.00
		●	H	1	HL	US735	75-140	0.40-1.00	1.50-8.00
		●	H	2	HM	US735	75-140	0.50-1.10	2.00-10.00
		✚	L	1	LM	MP7035	95-155	0.10-0.30	0.30-2.00
		✚	L	2	SH	US735	95-185	0.10-0.40	0.30-2.00
		✚	M	1	MM	MP7035	90-145	0.15-0.45	0.70-5.00
		✚	M	2	GM	MP7035	90-145	0.16-0.50	0.50-4.00
		✚	M	3	MA	MP7035	90-145	0.20-0.50	0.30-4.00
		✚	M	4	MS	US735	90-170	0.16-0.50	0.50-4.00
		✚	M	5	MS	VP15TF	80-135	0.16-0.50	0.50-4.00
		✚	M	6	MS	UP20M	100-150	0.16-0.50	0.50-4.00
		✚	M	7	MS	UTi20T	80-115	0.16-0.50	0.50-4.00
		✚	M	8	MA	VP15TF	80-135	0.20-0.50	0.30-4.00
		✚	M	9	Std	VP15TF	80-135	0.25-0.60	1.50-5.00
		✚	R	1	RM	MP7035	85-135	0.25-0.55	1.50-6.00
		✚	R	2	GH	US735	85-160	0.25-0.60	1.50-6.00
✚	H	1	HL	US735	75-140	0.40-1.00	1.50-8.00		
✚	H	2	HM	US735	75-140	0.50-1.10	2.00-10.00		
Ferritic and Martensitic Stainless Steel (X17CrNi162, X30Cr13)	>200HB	●	L	1	LM	MC7015	150-240	0.10-0.30	0.30-2.00
		●	L	2	SH	US735	80-155	0.10-0.40	0.30-2.00
		●	L	3	SH	NX2525	55-115	0.10-0.40	0.30-2.00
		●	M	1	MM	MC7015	135-215	0.15-0.45	0.70-5.00
		●	M	2	GM	MC7015	135-215	0.16-0.50	0.50-4.00
		●	R	1	RM	MC7015	130-205	0.25-0.55	1.50-6.00
		●	H	1	HL	US735	60-120	0.40-1.00	1.50-8.00
		●	H	2	HM	US735	60-120	0.50-1.10	2.00-10.00

CUTTING CONDITIONS : ● : Stable Cutting ● : General Cutting ✚ : Unstable Cutting

CUTTING AREA : F : Finish Cutting L : Light Cutting M : Medium Cutting R : Rough Cutting H : Heavy Cutting

Work Material	Hardness	Cutting Mode	Priority	Breaker	Grade	Cutting Speed (m/min)	Feed (mm/rev)	Depth of Cut (mm)	
Ferritic and Martensitic Stainless Steel (X17CrNi162, X30Cr13)	>200HB	☉	L	1	LM	MC7025	135–180	0.10–0.30	0.30–2.00
		☉	L	2	SH	US735	80–155	0.10–0.40	0.30–2.00
		☉	M	1	MM	MC7025	125–165	0.15–0.45	0.70–5.00
		☉	M	2	MA	MC7025	125–165	0.20–0.50	0.30–4.00
		☉	M	3	MA	US735	75–140	0.20–0.50	0.30–4.00
		☉	M	4	MS	US735	75–140	0.16–0.50	0.50–4.00
		☉	R	1	RM	MC7025	115–155	0.25–0.55	1.50–6.00
		☉	R	2	GH	US735	70–135	0.25–0.60	1.50–6.00
		☉	H	1	HL	US735	60–120	0.40–1.00	1.50–8.00
		☉	H	2	HM	US735	60–120	0.50–1.10	2.00–10.00
		☉	L	1	LM	MP7035	80–130	0.10–0.30	0.30–2.00
		☉	L	2	SH	US735	80–155	0.10–0.40	0.30–2.00
		☉	M	1	MM	MP7035	75–120	0.15–0.45	0.70–5.00
		☉	M	2	GM	MP7035	75–120	0.16–0.50	0.50–4.00
		☉	M	3	MA	MP7035	75–120	0.20–0.50	0.30–4.00
		☉	M	4	MS	US735	75–140	0.16–0.50	0.50–4.00
		☉	M	5	MS	VP15TF	65–110	0.16–0.50	0.50–4.00
		☉	M	6	MS	UP20M	80–125	0.16–0.50	0.50–4.00
		☉	M	7	MS	UTi20T	65–95	0.16–0.50	0.50–4.00
		☉	M	8	MA	VP15TF	65–110	0.20–0.50	0.30–4.00
		☉	M	9	Std	VP15TF	65–110	0.25–0.60	1.50–5.00
		☉	R	1	RM	MP7035	70–115	0.25–0.55	1.50–6.00
		☉	R	2	GH	US735	70–135	0.25–0.60	1.50–6.00
		☉	H	1	HL	US735	60–120	0.40–1.00	1.50–8.00
☉	H	2	HM	US735	60–120	0.50–1.10	2.00–10.00		
Hardened Stainless Steel (X5CrNiCuNb16-4, X7CrNiAl17-7)	<450HB	●	L	1	LM	MC7015	95–130	0.10–0.30	0.30–2.00
		●	L	2	LS(M)	MP9005	125–175	0.10–0.25	0.20–0.80
		●	L	3	SH	US735	55–100	0.10–0.40	0.30–2.00
		●	L	4	SH	NX2525	35–75	0.10–0.40	0.30–2.00
		●	M	1	MM	MC7015	90–120	0.15–0.45	0.70–5.00
		●	M	2	GM	MC7015	90–120	0.16–0.50	0.50–4.00
		●	M	3	MS	MP9005	115–160	0.15–0.30	0.50–3.00
		●	R	1	RM	MC7015	85–110	0.25–0.55	1.50–6.00
		●	H	1	HL	US735	40–80	0.40–1.00	1.50–8.00
		●	H	2	HM	US735	40–80	0.50–1.10	2.00–10.00
		☉	L	1	LM	MC7025	85–110	0.10–0.30	0.30–2.00
		☉	L	2	SH	US735	55–100	0.10–0.40	0.30–2.00
		☉	L	3	LS(M)	MP9015	120–165	0.10–0.25	0.20–0.80
		☉	M	1	MM	MC7025	80–100	0.15–0.45	0.70–5.00
		☉	M	2	GM	MC7025	80–100	0.16–0.50	0.50–4.00
		☉	M	3	MA	MC7025	80–100	0.10–0.30	0.50–3.00
		☉	M	4	MS	US735	50–95	0.15–0.30	0.50–3.00
		☉	M	5	MA	US735	50–95	0.10–0.30	0.50–3.00
		☉	M	6	MS	MP9015	110–150	0.15–0.30	0.50–3.00
		☉	R	1	RM	MC7025	75–95	0.25–0.55	1.50–6.00
		☉	R	2	GH	US735	45–90	0.25–0.60	1.50–6.00
		☉	R	3	RS	MP9015	100–140	0.20–0.35	1.00–4.00
		☉	H	1	HL	US735	40–80	0.40–1.00	1.50–8.00

M

TURNING INSERTS

RECOMMENDED CUTTING CONDITIONS

NEGATIVE INSERTS

Breaker : Std : Standard Flat : Flat Top

Work Material	Hardness	Cutting Mode	Priority	Breaker	Grade	Cutting Speed (m/min)	Feed (mm/rev)	Depth of Cut (mm)	
M Hardened Stainless Steel (X5CrNiCuNb16-4, X7CrNiAl17-7)	<450HB	●	H	2	HM	US735	40-80	0.50-1.10	2.00-10.00
		✚	L	1	LM	MP7035	55-85	0.10-0.30	0.30-2.00
		✚	L	2	SH	US735	55-100	0.10-0.40	0.30-2.00
		✚	L	3	LS(M)	MP9025	80-95	0.10-0.25	0.20-0.80
		✚	M	1	MM	MP7035	50-80	0.15-0.45	0.70-5.00
		✚	M	2	GM	MP7035	50-80	0.16-0.50	0.50-4.00
		✚	M	3	MA	MP7035	50-80	0.10-0.30	0.50-3.00
		✚	M	4	MS	US735	50-95	0.15-0.30	0.50-3.00
		✚	M	5	MS	VP15TF	45-75	0.15-0.30	0.50-3.00
		✚	M	6	MS	UP20M	55-85	0.15-0.30	0.50-3.00
		✚	M	7	MS	UTi20T	45-65	0.15-0.30	0.50-3.00
		✚	M	8	MA	VP15TF	45-75	0.10-0.30	0.50-3.00
		✚	M	9	Std	VP15TF	45-75	0.25-0.60	1.50-5.00
		✚	M	10	MS	MP9025	75-90	0.15-0.30	0.50-3.00
		✚	R	1	RM	MP7035	45-75	0.25-0.55	1.50-6.00
		✚	R	2	GH	US735	45-90	0.25-0.60	1.50-6.00
		✚	R	3	RS	MP9025	70-85	0.20-0.35	1.00-4.00
		✚	H	1	HL	US735	40-80	0.40-1.00	1.50-8.00
✚	H	2	HM	US735	40-80	0.50-1.10	2.00-10.00		

TURNING INSERTS

A

CUTTING CONDITIONS : ● : Stable Cutting ● : General Cutting ✚ : Unstable Cutting

CUTTING AREA : F : Finish Cutting L : Light Cutting M : Medium Cutting R : Rough Cutting H : Heavy Cutting

Work Material	Tensile Strength	Cutting Mode	Priority	Breaker	Grade	Cutting Speed (m/min)	Feed (mm/rev)	Depth of Cut (mm)			
Gray Cast Iron (GG30)	≤350MPa	●	L	1	LK	MC5005	230—365	0.10—0.40	0.30—2.00		
		●	L	2	MA	MC5005	210—335	0.20—0.50	0.30—4.00		
		●	M	1	MK	MC5005	210—335	0.20—0.55	1.00—4.00		
		●	M	2	GK	MC5005	210—335	0.25—0.60	1.50—5.00		
		●	M	3	Std	NX2525	155—210	0.25—0.60	1.50—5.00		
		●	M	4	MW	MC5005	210—335	0.20—0.60	0.90—4.00		
		●	R	1	RK	MC5005	195—315	0.25—0.60	1.50—6.00		
		●	R	2	Flat	MC5005	195—315	0.20—0.60	2.50—6.00		
		●	R	3	Flat	HTi10	95—140	0.20—0.60	2.50—6.00		
		●	H	1	Flat	MC5005	195—315	0.20—0.60	2.50—6.00		
		●	L	1	LK	MC5015	205—335	0.10—0.40	0.30—2.00		
		●	L	2	MA	MC5015	190—305	0.20—0.50	0.30—4.00		
		●	L	3	SW	MC5015	205—335	0.10—0.50	0.30—2.50		
		●	M	1	MK	MC5015	190—305	0.20—0.55	1.00—4.00		
		●	M	2	GK	MC5015	190—305	0.25—0.60	1.50—5.00		
		●	M	3	Std	HTi10	105—150	0.25—0.60	1.50—5.00		
		●	M	4	MW	MC5015	190—305	0.20—0.60	0.90—4.00		
		●	R	1	RK	MC5015	180—285	0.25—0.60	1.50—6.00		
		●	R	2	Flat	MC5015	180—285	0.20—0.60	2.50—6.00		
		●	H	1	Flat	MC5015	180—285	0.20—0.60	2.50—6.00		
		⊕	L	1	LK	MC5015	205—335	0.10—0.40	0.30—2.00		
		⊕	L	2	MA	MC5015	190—305	0.20—0.50	0.30—4.00		
		⊕	M	1	MK	MC5015	190—305	0.20—0.55	1.00—4.00		
		⊕	M	2	GK	MC5015	190—305	0.25—0.60	1.50—5.00		
		⊕	M	3	Std	UTi20T	85—120	0.25—0.60	1.50—5.00		
		⊕	R	1	RK	MC5015	180—285	0.25—0.60	1.50—6.00		
		⊕	R	2	Flat	MC5015	180—285	0.20—0.60	2.50—6.00		
		⊕	R	3	Flat	UTi20T	80—110	0.20—0.60	2.50—6.00		
		⊕	H	1	Flat	MC5015	180—285	0.20—0.60	2.50—6.00		
		Ductile Cast Iron (GGG40)	≤450MPa	●	L	1	LK	MC5005	215—350	0.10—0.40	0.30—2.00
				●	L	2	MA	MC5005	195—315	0.20—0.50	0.30—4.00
				●	M	1	MK	MC5005	195—315	0.20—0.55	1.00—4.00
●	M			2	GK	MC5005	195—315	0.25—0.60	1.50—5.00		
●	M			3	Std	NX2525	145—195	0.25—0.60	1.50—5.00		
●	R			1	RK	MC5005	185—300	0.25—0.60	1.50—6.00		
●	R			2	Flat	MC5005	185—300	0.20—0.60	2.50—6.00		
●	R			3	Flat	HTi10	90—135	0.20—0.60	2.50—6.00		
●	H			1	Flat	MC5005	185—300	0.20—0.60	2.50—6.00		
●	L			1	LK	MC5015	195—315	0.10—0.40	0.30—2.00		
●	L			2	MA	MC5015	180—285	0.20—0.50	0.30—4.00		
●	L			3	SW	MC5015	195—315	0.10—0.50	0.30—2.50		
●	M			1	MK	MC5015	180—285	0.20—0.55	1.00—4.00		
●	M			2	GK	MC5015	180—285	0.25—0.60	1.50—5.00		
●	M			3	Std	HTi10	95—140	0.25—0.60	1.50—5.00		
●	R			1	RK	MC5015	170—275	0.25—0.60	1.50—6.00		
●	R			2	Flat	MC5015	170—275	0.20—0.60	2.50—6.00		
●	H			1	Flat	MC5015	170—275	0.20—0.60	2.50—6.00		
⊕	L			1	LK	MC5015	195—315	0.10—0.40	0.30—2.00		

K

TURNING INSERTS

RECOMMENDED CUTTING CONDITIONS

NEGATIVE INSERTS

Breaker : Std : Standard Flat : Flat Top

Work Material	Tensile Strength	Cutting Mode	Priority	Breaker	Grade	Cutting Speed (m/min)	Feed (mm/rev)	Depth of Cut (mm)	
Ductile Cast Iron (GGG40)	≤450MPa	✚	L	2	MA	MC5015	180-285	0.20-0.50	0.30-4.00
		✚	M	1	MK	MC5015	180-285	0.20-0.55	1.00-4.00
		✚	M	2	GK	MC5015	180-285	0.25-0.60	1.50-5.00
		✚	M	3	Std	UTi20T	80-110	0.25-0.60	1.50-5.00
		✚	R	1	RK	MC5015	170-275	0.25-0.60	1.50-6.00
		✚	R	2	Flat	MC5015	170-275	0.20-0.60	2.50-6.00
		✚	R	3	Flat	UTi20T	75-105	0.20-0.60	2.50-6.00
Ductile Cast Iron (GGG70)	≤800MPa	●	L	1	LK	MC5005	195-310	0.10-0.40	0.30-2.00
		●	L	2	MA	MC5005	175-280	0.20-0.50	0.30-4.00
		●	M	1	MK	MC5005	175-280	0.20-0.55	1.00-4.00
		●	M	2	GK	MC5005	175-280	0.25-0.60	1.50-5.00
		●	M	3	Std	NX2525	130-175	0.25-0.60	1.50-5.00
		●	R	1	RK	MC5005	165-270	0.25-0.60	1.50-6.00
		●	R	2	Flat	MC5005	165-270	0.20-0.60	2.50-6.00
		●	R	3	Flat	HTi10	80-120	0.20-0.60	2.50-6.00
		●	H	1	Flat	MC5005	165-270	0.20-0.60	2.50-6.00
		●	L	1	LK	MC5015	175-285	0.10-0.40	0.30-2.00
		●	L	2	MA	MC5015	160-255	0.20-0.50	0.30-4.00
		●	L	3	SW	MC5015	175-285	0.10-0.50	0.30-2.50
		●	M	1	MK	MC5015	160-255	0.20-0.55	1.00-4.00
		●	M	2	GK	MC5015	160-255	0.25-0.60	1.50-5.00
		●	M	3	Std	HTi10	85-125	0.25-0.60	1.50-5.00
		●	R	1	RK	MC5015	150-245	0.25-0.60	1.50-6.00
		●	R	2	Flat	MC5015	150-245	0.20-0.60	2.50-6.00
		●	H	1	Flat	MC5015	150-245	0.20-0.60	2.50-6.00
		✚	L	1	LK	MC5015	175-285	0.10-0.40	0.30-2.00
		✚	L	2	MA	MC5015	160-255	0.20-0.50	0.30-4.00
		✚	M	1	MK	MC5015	160-255	0.20-0.55	1.00-4.00
		✚	M	2	GK	MC5015	160-255	0.25-0.60	1.50-5.00
		✚	M	3	Std	UTi20T	70-100	0.25-0.60	1.50-5.00
		✚	R	1	RK	MC5015	150-245	0.25-0.60	1.50-6.00
		✚	R	2	Flat	MC5015	150-245	0.20-0.60	2.50-6.00
		✚	R	3	Flat	UTi20T	65-95	0.20-0.60	2.50-6.00
		✚	H	1	Flat	MC5015	150-245	0.20-0.60	2.50-6.00

CUTTING CONDITIONS : ● : Stable Cutting ● : General Cutting ✚ : Unstable Cutting

CUTTING AREA : F : Finish Cutting L : Light Cutting M : Medium Cutting R : Rough Cutting H : Heavy Cutting

Work Material	Hardness	Cutting Mode	Priority	Breaker	Grade	Cutting Speed (m/min)	Feed (mm/rev)	Depth of Cut (mm)			
Titanium Alloy (Ti-6Al-4V)	—	●	F	1	LS(M)	MT9015	40–85	0.10–0.25	0.20–0.80		
		●	F	2	FJ	RT9010	45–95	0.07–0.20	0.10–1.00		
		●	L	1	LS(M)	MT9015	40–85	0.10–0.25	0.20–0.80		
		●	L	2	MJ(M)	RT9010	40–85	0.07–0.25	0.40–1.50		
		●	M	1	MS	MT9015	40–80	0.15–0.30	0.50–3.00		
		●	M	2	MS	RT9010	40–80	0.15–0.30	0.50–3.00		
		●	R	1	RS	MT9015	35–75	0.20–0.35	1.00–4.00		
		●	R	2	GJ	RT9010	35–75	0.16–0.35	1.00–3.00		
		●	F	1	LS(M)	MT9015	40–85	0.10–0.25	0.20–0.80		
		●	F	2	FJ	RT9010	45–95	0.07–0.20	0.10–1.00		
		●	L	1	LS(M)	MT9015	40–85	0.10–0.25	0.20–0.80		
		●	L	2	MJ(M)	RT9010	40–85	0.07–0.25	0.40–1.50		
		●	L	3	MJ(G)	RT9010	40–85	0.07–0.25	0.40–1.50		
		●	M	1	MS	MT9015	40–80	0.15–0.30	0.50–3.00		
		●	M	2	MS	RT9010	40–80	0.15–0.30	0.50–3.00		
		●	R	1	RS	MT9015	35–75	0.20–0.35	1.00–4.00		
		●	R	2	GJ	RT9010	35–75	0.16–0.35	1.00–3.00		
		⊕	F	1	LS(M)	MT9015	40–85	0.10–0.25	0.20–0.80		
		⊕	F	2	FJ	RT9010	45–95	0.07–0.20	0.10–1.00		
		⊕	L	1	LS(M)	MT9015	40–85	0.10–0.25	0.20–0.80		
		⊕	L	2	MJ(M)	RT9010	40–85	0.07–0.25	0.40–1.50		
		⊕	L	3	MJ(G)	RT9010	40–85	0.07–0.25	0.40–1.50		
		⊕	M	1	MS	MT9015	40–80	0.15–0.30	0.50–3.00		
		⊕	R	1	RS	MT9015	35–75	0.20–0.35	1.00–4.00		
		⊕	R	2	GJ	RT9010	35–75	0.16–0.35	1.00–3.00		
		Heat Resistant Alloy (Inconel718)	—	●	F	1	LS(M)	MP9005	30–110	0.10–0.25	0.20–0.80
				●	F	2	FJ	VP10RT	30–60	0.07–0.20	0.10–1.00
				●	L	1	LS(M)	MP9005	30–110	0.10–0.25	0.20–0.80
●	L			2	MJ(M)	MP9005	30–110	0.07–0.25	0.40–1.50		
●	L			3	MJ(M)	VP05RT	30–65	0.07–0.25	0.40–1.50		
●	L			4	MJ(M)	US905	55–110	0.07–0.25	0.40–1.50		
●	L			5	MJ(G)	VP10RT	25–55	0.07–0.25	0.40–1.50		
●	M			1	MS	MP9005	30–100	0.15–0.30	0.50–3.00		
●	M			2	MS	VP05RT	30–60	0.15–0.30	0.50–3.00		
●	M			3	MS	US905	50–100	0.15–0.30	0.50–3.00		
●	R			1	RS	MP9015	20–75	0.20–0.35	1.00–4.00		
●	R			2	GJ	VP10RT	20–45	0.16–0.35	1.00–3.00		
●	R			3	GJ	US905	45–95	0.16–0.35	1.00–3.00		
●	F			1	LS(M)	MP9015	25–85	0.10–0.25	0.20–0.80		
●	F			2	FJ	VP10RT	30–60	0.07–0.20	0.10–1.00		
●	L			1	LS(M)	MP9015	25–85	0.10–0.25	0.20–0.80		
●	L			2	MJ(M)	MP9015	25–80	0.07–0.25	0.40–1.50		
●	L			3	MJ(M)	VP10RT	25–55	0.07–0.25	0.40–1.50		
●	M			1	MS	MP9015	25–80	0.15–0.30	0.50–3.00		
●	M			2	MA	MP9015	25–80	0.10–0.30	0.50–3.00		
●	M			3	MS	VP10RT	25–50	0.15–0.30	0.50–3.00		
●	R			1	RS	MP9015	20–75	0.20–0.35	1.00–4.00		
●	R			2	GJ	VP10RT	20–45	0.16–0.35	1.00–3.00		

TURNING INSERTS

RECOMMENDED CUTTING CONDITIONS

■ NEGATIVE INSERTS

Breaker : Std : Standard Flat : Flat Top

Work Material	Hardness	Cutting Mode	Priority	Breaker	Grade	Cutting Speed (m/min)	Feed (mm/rev)	Depth of Cut (mm)	
Heat Resistant Alloy (Inconel718)	—	✚	F	1	LS(M)	MP9025	20—30	0.10—0.25	0.20—0.80
		✚	F	2	FJ	VP15TF	20—40	0.07—0.20	0.10—1.00
		✚	L	1	LS(M)	MP9025	20—30	0.10—0.25	0.20—0.80
		✚	L	2	MJ(G)	VP15TF	20—35	0.07—0.25	0.40—1.50
		✚	M	1	MS	MP9025	20—30	0.15—0.30	0.50—3.00
		✚	M	2	MA	MP9025	20—30	0.10—0.30	0.50—3.00
		✚	M	3	MS	VP15TF	20—35	0.15—0.30	0.50—3.00
		✚	R	1	RS	MP9025	15—25	0.20—0.35	1.00—4.00
		✚	R	2	GJ	VP15TF	15—30	0.16—0.35	1.00—3.00

TURNING INSERTS

A

CUTTING CONDITIONS : ● : Stable Cutting ● : General Cutting ✚ : Unstable Cutting

CUTTING AREA : F : Finish Cutting L : Light Cutting M : Medium Cutting R : Rough Cutting H : Heavy Cutting

7° POSITIVE INSERT TYPE

Work Material	Hardness	Cutting Mode	Priority	Breaker	Grade	Cutting Speed (m/min)	Feed (mm/rev)	Depth of Cut (mm)	
Mild Steel (St37-2, Ck10)	≤180HB	●	F	1	FP	NX2525	225-320	0.04-0.20	0.20-0.90
		●	F	2	FV	NX2525	225-320	0.04-0.20	0.20-0.90
		●	F	3	R/L-F	MP3025	230-355	0.05-0.12	0.10-0.50
		●	L	1	LP	NX2525	225-320	0.06-0.25	0.20-1.00
		●	L	2	Std	UE6110	210-355	0.08-0.30	0.30-2.00
		●	L	3	MV	MP3025	190-295	0.08-0.30	0.30-2.00
		●	L	4	Std	MP3025	190-295	0.08-0.30	0.30-2.00
		●	M	1	MP	NX2525	185-270	0.08-0.30	0.30-2.00
		●	F	1	FP	MC6015	250-425	0.04-0.20	0.20-0.90
		●	F	2	FP	UE6110	250-425	0.04-0.20	0.20-0.90
		●	F	3	FP	MP3025	230-355	0.04-0.20	0.20-0.90
		●	F	4	FV	MP3025	230-355	0.04-0.20	0.20-0.90
		●	F	5	FV	NX3035	220-310	0.04-0.20	0.20-0.90
		●	L	1	LP	MC6015	250-425	0.06-0.25	0.20-1.00
		●	L	2	LP	UE6110	250-425	0.06-0.25	0.20-1.00
		●	L	3	LP	MP3025	230-355	0.06-0.25	0.20-1.00
		●	L	4	Std	UE6110	210-355	0.08-0.30	0.30-2.00
		●	L	5	SW	MC6015	250-425	0.06-0.24	0.20-1.50
		●	L	6	SW	MP3025	230-355	0.06-0.24	0.20-1.50
		●	M	1	MP	MC6015	210-355	0.08-0.30	0.30-2.00
		●	M	2	MP	UE6110	210-355	0.08-0.30	0.30-2.00
		●	M	3	MP	MP3025	190-295	0.08-0.30	0.30-2.00
		●	M	4	MW	MC6015	210-355	0.10-0.35	0.80-2.50
		⊕	F	1	FP	MC6025	250-405	0.04-0.20	0.20-0.90
		⊕	L	1	LP	MC6025	250-405	0.06-0.25	0.20-1.00
		⊕	L	2	SV	MC6025	250-405	0.06-0.25	0.20-1.00
		⊕	L	3	SW	MC6025	250-405	0.06-0.24	0.20-1.50
		⊕	M	1	MP	MC6025	210-340	0.08-0.30	0.30-2.00
		⊕	M	2	MW	MC6025	210-340	0.10-0.35	0.80-2.50
		Carbon Steel • Alloy Steel (Ck45, 42CrMo4)	180 280HB	●	F	1	FP	NX2525	165-240
●	F			2	FV	NX2525	165-240	0.04-0.20	0.20-0.90
●	F			3	R/L-F	MP3025	170-260	0.05-0.12	0.10-0.50
●	L			1	LP	NX2525	165-240	0.06-0.25	0.20-1.00
●	L			2	Std	UE6110	155-260	0.08-0.30	0.30-2.00
●	L			3	MV	MP3025	140-220	0.08-0.30	0.30-2.00
●	L			4	Std	MP3025	140-220	0.08-0.30	0.30-2.00
●	L			5	SV	MP3025	170-260	0.06-0.25	0.20-1.00
●	L			6	SW	MP3025	170-260	0.06-0.24	0.20-1.50
●	M			1	MP	NX2525	140-200	0.08-0.30	0.30-2.00
●	M			2	MW	MP3025	140-220	0.10-0.35	0.80-2.50
●	F			1	FP	MC6015	185-315	0.04-0.20	0.20-0.90
●	F			2	FP	UE6110	185-315	0.04-0.20	0.20-0.90
●	F			3	FP	MP3025	170-260	0.04-0.20	0.20-0.90
●	F			4	FV	MP3025	170-260	0.04-0.20	0.20-0.90
●	F			5	FV	NX3035	160-230	0.04-0.20	0.20-0.90
●	L			1	LP	MC6015	185-315	0.06-0.25	0.20-1.00

TURNING INSERTS

A

P

TURNING INSERTS

RECOMMENDED CUTTING CONDITIONS

7° POSITIVE INSERT TYPE

Breaker : Std : Standard Flat : Flat Top

Work Material	Hardness	Cutting Mode	Priority	Breaker	Grade	Cutting Speed (m/min)	Feed (mm/rev)	Depth of Cut (mm)	
Carbon Steel • Alloy Steel (Ck45, 42CrMo4)	180 280HB	●	L	2	LP	UE6110	185–315	0.06–0.25	0.20–1.00
		●	L	3	LP	MP3025	170–260	0.06–0.25	0.20–1.00
		●	L	4	Std	UE6110	155–260	0.08–0.30	0.30–2.00
		●	L	5	SW	MC6015	185–315	0.06–0.24	0.20–1.50
		●	L	6	SW	MP3025	170–260	0.06–0.24	0.20–1.50
		●	M	1	MP	MC6015	155–260	0.08–0.30	0.30–2.00
		●	M	2	MP	UE6110	155–260	0.08–0.30	0.30–2.00
		●	M	3	MP	MP3025	140–220	0.08–0.30	0.30–2.00
		●	M	4	MW	MC6015	155–260	0.10–0.35	0.80–2.50
		✚	F	1	FP	MC6025	185–300	0.04–0.20	0.20–0.90
		✚	L	1	LP	MC6025	185–300	0.06–0.25	0.20–1.00
		✚	L	2	SV	MC6025	185–300	0.06–0.25	0.20–1.00
		✚	L	3	SW	MC6025	185–300	0.06–0.24	0.20–1.50
		✚	M	1	MP	MC6025	155–250	0.08–0.30	0.30–2.00
		✚	M	2	MW	MC6025	155–250	0.10–0.35	0.80–2.50
		Carbon Steel • Alloy Steel (40CrNiMoA)	280 350HB	●	M	1	MP	NX2525	95–140
●	M			1	MP	MC6015	110–185	0.08–0.30	0.30–2.00
●	M			2	MP	UE6110	110–185	0.08–0.30	0.30–2.00
●	M			3	MP	MP3025	100–155	0.08–0.30	0.30–2.00
✚	M			1	MP	MC6025	110–175	0.08–0.30	0.30–2.00

A

TURNING INSERTS

P

CUTTING CONDITIONS : ● : Stable Cutting ● : General Cutting ✚ : Unstable Cutting

CUTTING AREA : F : Finish Cutting L : Light Cutting M : Medium Cutting R : Rough Cutting H : Heavy Cutting

Work Material	Hardness	Cutting Mode	Priority	Breaker	Grade	Cutting Speed (m/min)	Feed (mm/rev)	Depth of Cut (mm)	
Austenitic Stainless Steel (X5CrNi189, X5CrNiMo1810)	≤200HB	●	F	1	FM	VP15TF	75–125	0.04–0.20	0.20–0.90
		●	F	2	Std	US735	70–135	0.08–0.30	0.30–2.00
		●	L	1	LM	MC7025	140–190	0.06–0.25	0.20–1.00
		●	L	2	Std	US735	70–135	0.08–0.30	0.30–2.00
		●	M	1	MM	MC7025	120–160	0.08–0.30	0.30–2.00
		●	F	1	FM	VP15TF	75–125	0.04–0.20	0.20–0.90
		●	F	2	Std	US735	70–135	0.08–0.30	0.30–2.00
		●	L	1	LM	MC7025	140–190	0.06–0.25	0.20–1.00
		●	L	2	Std	US735	70–135	0.08–0.30	0.30–2.00
		●	M	1	MM	MC7025	120–160	0.08–0.30	0.30–2.00
		⊕	F	1	FM	VP15TF	75–125	0.04–0.20	0.20–0.90
		⊕	F	2	Std	US735	70–135	0.08–0.30	0.30–2.00
		⊕	L	1	LM	MP7035	85–135	0.06–0.25	0.20–1.00
		⊕	L	2	LM	VP15TF	75–125	0.06–0.25	0.20–1.00
		⊕	L	3	Std	US735	70–135	0.08–0.30	0.30–2.00
		⊕	M	1	MM	MP7035	70–115	0.08–0.30	0.30–2.00
⊕	M	2	MM	VP15TF	60–105	0.08–0.30	0.30–2.00		
Austenitic Stainless Steel (X2CrNiN1810, X2CrNiMoN1813)	>200HB	●	F	1	FM	VP15TF	60–105	0.04–0.20	0.20–0.90
		●	F	2	Std	US735	60–110	0.08–0.30	0.30–2.00
		●	L	1	LM	MC7025	120–160	0.06–0.25	0.20–1.00
		●	L	2	Std	US735	60–110	0.08–0.30	0.30–2.00
		●	M	1	MM	MC7025	100–130	0.08–0.30	0.30–2.00
		●	F	1	FM	VP15TF	60–105	0.04–0.20	0.20–0.90
		●	F	2	Std	US735	60–110	0.08–0.30	0.30–2.00
		●	L	1	LM	MC7025	120–160	0.06–0.25	0.20–1.00
		●	L	2	Std	US735	60–110	0.08–0.30	0.30–2.00
		●	M	1	MM	MC7025	100–130	0.08–0.30	0.30–2.00
		⊕	F	1	FM	VP15TF	60–105	0.04–0.20	0.20–0.90
		⊕	F	2	Std	US735	60–110	0.08–0.30	0.30–2.00
		⊕	L	1	LM	MP7035	70–115	0.06–0.25	0.20–1.00
		⊕	L	2	LM	VP15TF	60–105	0.06–0.25	0.20–1.00
		⊕	L	3	Std	US735	60–110	0.08–0.30	0.30–2.00
		⊕	M	1	MM	MP7035	60–95	0.08–0.30	0.30–2.00
⊕	M	2	MM	VP15TF	50–90	0.08–0.30	0.30–2.00		
Two-phase Stainless Steel (X3CrNiCu1894)	≤280HB	●	F	1	FM	VP15TF	50–85	0.04–0.20	0.20–0.90
		●	F	2	Std	US735	45–90	0.08–0.30	0.30–2.00
		●	L	1	LM	MC7025	95–130	0.06–0.25	0.20–1.00
		●	L	2	Std	US735	45–90	0.08–0.30	0.30–2.00
		●	M	1	MM	MC7025	80–105	0.08–0.30	0.30–2.00
		●	F	1	FM	VP15TF	50–85	0.04–0.20	0.20–0.90
		●	F	2	Std	US735	45–90	0.08–0.30	0.30–2.00
		●	L	1	LM	MC7025	95–130	0.06–0.25	0.20–1.00
		●	L	2	Std	US735	45–90	0.08–0.30	0.30–2.00
		●	M	1	MM	MC7025	80–105	0.08–0.30	0.30–2.00
		⊕	F	1	FM	VP15TF	50–85	0.04–0.20	0.20–0.90
		⊕	F	2	Std	US735	45–90	0.08–0.30	0.30–2.00
		⊕	L	1	LM	MP7035	55–90	0.06–0.25	0.20–1.00
		⊕	L	2	LM	VP15TF	50–85	0.06–0.25	0.20–1.00

M

TURNING INSERTS

RECOMMENDED CUTTING CONDITIONS

7° POSITIVE INSERT TYPE

Breaker : Std : Standard Flat : Flat Top

Work Material	Hardness	Cutting Mode		Priority	Breaker	Grade	Cutting Speed (m/min)	Feed (mm/rev)	Depth of Cut (mm)
		Symbol	Area						
Two-phase Stainless Steel (X3CrNiCu1894)	≤280HB	✚	L	3	Std	US735	45-90	0.08-0.30	0.30-2.00
		✚	M	1	MM	MP7035	45-75	0.08-0.30	0.30-2.00
		✚	M	2	MM	VP15TF	40-70	0.08-0.30	0.30-2.00
Ferritic and Martensitic Stainless Steel (X10Cr13, X8Cr17)	≤200HB	●	F	1	FM	VP15TF	75-125	0.04-0.20	0.20-0.90
		●	F	2	Std	US735	70-135	0.08-0.30	0.30-2.00
		●	L	1	LM	MC7025	140-190	0.06-0.25	0.20-1.00
		●	L	2	Std	US735	70-135	0.08-0.30	0.30-2.00
		●	M	1	MM	MC7025	120-160	0.08-0.30	0.30-2.00
		●	F	1	FM	VP15TF	75-125	0.04-0.20	0.20-0.90
		●	F	2	Std	US735	70-135	0.08-0.30	0.30-2.00
		●	L	1	LM	MC7025	140-190	0.06-0.25	0.20-1.00
		●	L	2	Std	US735	70-135	0.08-0.30	0.30-2.00
		●	M	1	MM	MC7025	120-160	0.08-0.30	0.30-2.00
		✚	F	1	FM	VP15TF	75-125	0.04-0.20	0.20-0.90
		✚	F	2	Std	US735	70-135	0.08-0.30	0.30-2.00
		✚	L	1	LM	MP7035	85-135	0.06-0.25	0.20-1.00
		✚	L	2	LM	VP15TF	75-125	0.06-0.25	0.20-1.00
		✚	L	3	Std	US735	70-135	0.08-0.30	0.30-2.00
		✚	M	1	MM	MP7035	70-115	0.08-0.30	0.30-2.00
✚	M	2	MM	VP15TF	60-105	0.08-0.30	0.30-2.00		
Ferritic and Martensitic Stainless Steel (X17CrNi162, X30Cr13)	>200HB	●	F	1	FM	VP15TF	60-105	0.04-0.20	0.20-0.90
		●	F	2	Std	US735	60-110	0.08-0.30	0.30-2.00
		●	L	1	LM	MC7025	120-160	0.06-0.25	0.20-1.00
		●	L	2	Std	US735	60-110	0.08-0.30	0.30-2.00
		●	M	1	MM	MC7025	100-130	0.08-0.30	0.30-2.00
		●	F	1	FM	VP15TF	60-105	0.04-0.20	0.20-0.90
		●	F	2	Std	US735	60-110	0.08-0.30	0.30-2.00
		●	L	1	LM	MC7025	120-160	0.06-0.25	0.20-1.00
		●	L	2	Std	US735	60-110	0.08-0.30	0.30-2.00
		●	M	1	MM	MC7025	100-130	0.08-0.30	0.30-2.00
		✚	F	1	FM	VP15TF	60-105	0.04-0.20	0.20-0.90
		✚	F	2	Std	US735	60-110	0.08-0.30	0.30-2.00
		✚	L	1	LM	MP7035	70-115	0.06-0.25	0.20-1.00
		✚	L	2	LM	VP15TF	60-105	0.06-0.25	0.20-1.00
		✚	L	3	Std	US735	60-110	0.08-0.30	0.30-2.00
		✚	M	1	MM	MP7035	60-95	0.08-0.30	0.30-2.00
✚	M	2	MM	VP15TF	50-90	0.08-0.30	0.30-2.00		
Hardened Stainless Steel (X5CrNiCuNb16-4, X7CrNiAl17-7)	<450HB	●	F	1	FM	VP15TF	40-70	0.04-0.20	0.20-0.90
		●	F	2	FS	MP9005	110-150	0.04-0.12	0.20-1.40
		●	F	3	Std	US735	40-75	0.08-0.25	0.30-2.00
		●	L	1	LM	MC7025	75-95	0.06-0.20	0.20-1.00
		●	L	2	LS(G)	MP9015	105-140	0.04-0.15	0.30-3.00
		●	L	3	LS(M)	MP9015	105-140	0.06-0.20	0.20-1.00
		●	L	4	Std	US735	40-75	0.08-0.25	0.30-2.00
		●	M	1	MM	MC7025	60-80	0.08-0.25	0.30-2.00
		●	M	2	MS	MP9015	85-120	0.08-0.25	0.30-2.00
		●	M	3	RCMT-Std	MP9015	85-120	0.25-0.45	1.50-3.00
●	F	1	FM	VP15TF	40-70	0.04-0.20	0.20-0.90		

CUTTING CONDITIONS : ● : Stable Cutting ● : General Cutting ✚ : Unstable Cutting

CUTTING AREA : F : Finish Cutting L : Light Cutting M : Medium Cutting R : Rough Cutting H : Heavy Cutting

Work Material	Hardness	Cutting Mode	Priority	Breaker	Grade	Cutting Speed (m/min)	Feed (mm/rev)	Depth of Cut (mm)	
M Hardened Stainless Steel (X5CrNiCuNb16-4, X7CrNiAl17-7)	<450HB	●	F	2	FS	MP9015	105–140	0.04–0.12	0.20–1.40
		●	F	3	Std	US735	40–75	0.08–0.25	0.30–2.00
		●	L	1	LM	MC7025	75–95	0.06–0.20	0.20–1.00
		●	L	2	LS(G)	MP9015	105–140	0.04–0.15	0.30–3.00
		●	L	3	LS(M)	MP9015	105–140	0.06–0.20	0.20–1.00
		●	L	4	Std	US735	40–75	0.08–0.25	0.30–2.00
		●	M	1	MM	MC7025	60–80	0.08–0.25	0.30–2.00
		●	M	2	MS	MP9015	85–120	0.08–0.25	0.30–2.00
		●	M	3	RCMT-Std	MP9015	85–120	0.25–0.45	1.50–3.00
		⊕	F	1	FM	VP15TF	40–70	0.04–0.20	0.20–0.90
		⊕	F	2	Std	US735	40–75	0.08–0.25	0.30–2.00
		⊕	L	1	LM	MP7035	45–75	0.06–0.20	0.20–1.00
		⊕	L	2	LS(M)	MP9025	70–85	0.06–0.20	0.20–1.00
		⊕	L	3	LM	VP15TF	40–70	0.06–0.20	0.20–1.00
		⊕	L	4	Std	US735	40–75	0.08–0.25	0.30–2.00
		⊕	M	1	MM	MP7035	40–60	0.08–0.25	0.30–2.00
		⊕	M	2	MS	MP9025	60–70	0.08–0.25	0.30–2.00
		⊕	M	3	MM	VP15TF	35–60	0.08–0.25	0.30–2.00
		⊕	M	4	RCMT-Std	MP9025	60–70	0.25–0.45	1.50–3.00

A

TURNING INSERTS

TURNING INSERTS

RECOMMENDED CUTTING CONDITIONS

7° POSITIVE INSERT TYPE

Breaker : Std : Standard Flat : Flat Top

Work Material	Tensile Strength	Cutting Mode		Priority	Breaker	Grade	Cutting Speed (m/min)	Feed (mm/rev)	Depth of Cut (mm)
		●	F						
Gray Cast Iron (GG30)	≤350MPa	●	F	1	MK	MC5005	165-265	0.08-0.30	0.30-2.00
		●	L	1	MK	MC5005	165-265	0.08-0.30	0.30-2.00
		●	M	1	Flat	MC5005	165-265	0.08-0.30	0.30-2.00
		●	F	1	MK	MC5015	150-240	0.08-0.30	0.30-2.00
		●	L	1	MK	MC5015	150-240	0.08-0.30	0.30-2.00
		●	M	1	Flat	MC5015	150-240	0.08-0.30	0.30-2.00
		✚	F	1	MK	MC5015	150-240	0.08-0.30	0.30-2.00
		✚	L	1	MK	MC5015	150-240	0.08-0.30	0.30-2.00
		✚	M	1	Flat	MC5015	150-240	0.08-0.30	0.30-2.00
Ductile Cast Iron (GGG40)	≤450MPa	●	F	1	MK	MC5005	155-250	0.08-0.30	0.30-2.00
		●	L	1	MK	MC5005	155-250	0.08-0.30	0.30-2.00
		●	M	1	Flat	MC5005	155-250	0.08-0.30	0.30-2.00
		●	F	1	MK	MC5015	140-230	0.08-0.30	0.30-2.00
		●	L	1	MK	MC5015	140-230	0.08-0.30	0.30-2.00
		●	M	1	Flat	MC5015	140-230	0.08-0.30	0.30-2.00
		✚	F	1	MK	MC5015	140-230	0.08-0.30	0.30-2.00
		✚	L	1	MK	MC5015	140-230	0.08-0.30	0.30-2.00
		✚	M	1	Flat	MC5015	140-230	0.08-0.30	0.30-2.00
Ductile Cast Iron (GGG70)	≤800MPa	●	F	1	MK	MC5005	140-225	0.08-0.30	0.30-2.00
		●	L	1	MK	MC5005	140-225	0.08-0.30	0.30-2.00
		●	M	1	Flat	MC5005	140-225	0.08-0.30	0.30-2.00
		●	F	1	MK	MC5015	125-205	0.08-0.30	0.30-2.00
		●	L	1	MK	MC5015	125-205	0.08-0.30	0.30-2.00
		●	M	1	Flat	MC5015	125-205	0.08-0.30	0.30-2.00
		✚	F	1	MK	MC5015	125-205	0.08-0.30	0.30-2.00
		✚	L	1	MK	MC5015	125-205	0.08-0.30	0.30-2.00
		✚	M	1	Flat	MC5015	125-205	0.08-0.30	0.30-2.00

A

TURNING INSERTS

K

CUTTING CONDITIONS : ● : Stable Cutting ● : General Cutting ✚ : Unstable Cutting

CUTTING AREA : F : Finish Cutting L : Light Cutting M : Medium Cutting R : Rough Cutting H : Heavy Cutting

Work Material	Hardness	Cutting Mode	Priority	Breaker	Grade	Cutting Speed (m/min)	Feed (mm/rev)	Depth of Cut (mm)		
N	Aluminium Alloy (A6061, A7075)	●	F	1	AZ	HTi10	300–700	0.10–0.40	0.20–3.00	
		◐	F	1	AZ	HTi10	300–700	0.10–0.40	0.20–3.00	
		⊕	F	1	AZ	HTi10	300–700	0.10–0.40	0.20–3.00	
	Aluminium Alloy (AC4B)	5% ≤ Si ≤ 10%	●	F	1	AZ	HTi10	300–700	0.10–0.40	0.20–3.00
			◐	F	1	AZ	HTi10	300–700	0.10–0.40	0.20–3.00
			⊕	F	1	AZ	HTi10	300–700	0.10–0.40	0.20–3.00
	Aluminium Alloy (ADC12, A390)	Si > 10%	●	F	1	AZ	HTi10	300–700	0.10–0.40	0.20–3.00
			◐	F	1	AZ	HTi10	300–700	0.10–0.40	0.20–3.00
			⊕	F	1	AZ	HTi10	300–700	0.10–0.40	0.20–3.00

A

TURNING INSERTS

TURNING INSERTS

RECOMMENDED CUTTING CONDITIONS

7° POSITIVE INSERT TYPE

Breaker : Std : Standard Flat : Flat Top

Work Material	Hardness	Cutting Mode		Priority	Breaker	Grade	Cutting Speed (m/min)	Feed (mm/rev)	Depth of Cut (mm)
		●	●						
Titanium Alloy (Ti-6Al-4V)	—	●	F	1	FS-P	MT9005	40-80	0.04-0.12	0.20-1.40
		●	F	2	FJ	RT9010	35-75	0.04-0.12	0.20-1.40
		●	L	1	LS-P	MT9005	40-80	0.04-0.15	0.30-3.00
		●	L	2	LS(M)	MT9005	40-80	0.06-0.20	0.20-1.00
		●	M	1	MS	MT9005	35-65	0.08-0.25	0.30-2.00
		●	M	2	RCMT-Std	MT9005	35-65	0.25-0.45	1.50-3.00
		●	F	1	FS-P	MT9005	40-80	0.04-0.12	0.20-1.40
		●	F	2	FJ	RT9010	35-75	0.04-0.12	0.20-1.40
		●	L	1	LS-P	MT9005	40-80	0.04-0.15	0.30-3.00
		●	L	2	LS(M)	MT9005	40-80	0.06-0.20	0.20-1.00
		●	M	1	MS	MT9005	35-65	0.08-0.25	0.30-2.00
		●	M	2	RCMT-Std	MT9005	35-65	0.25-0.45	1.50-3.00
		✚	F	1	FS-P	MT9005	40-80	0.04-0.12	0.20-1.40
		✚	F	2	FJ	RT9010	35-75	0.04-0.12	0.20-1.40
		✚	L	1	LS-P	MT9005	40-80	0.04-0.15	0.30-3.00
		✚	L	2	LS(M)	MT9005	40-80	0.06-0.20	0.20-1.00
		✚	M	1	MS	MT9005	35-65	0.08-0.25	0.30-2.00
		✚	M	2	RCMT-Std	MT9015	30-60	0.25-0.45	1.50-3.00
Heat Resistant Alloy (Inconel718)	—	●	F	1	FS	MP9005	25-95	0.04-0.12	0.20-1.40
		●	F	2	FJ	VP10RT	20-45	0.04-0.12	0.20-1.40
		●	L	1	LS(G)	MP9005	25-95	0.04-0.15	0.30-3.00
		●	L	2	LS(M)	MP9005	25-95	0.06-0.20	0.20-1.00
		●	M	1	MS	MP9005	20-80	0.08-0.25	0.30-2.00
		●	M	2	RCMT-Std	MP9005	20-80	0.25-0.45	1.50-3.00
		●	F	1	FS	MP9015	20-75	0.04-0.12	0.20-1.40
		●	F	2	FJ	VP10RT	20-45	0.04-0.12	0.20-1.40
		●	L	1	LS(G)	MP9015	20-75	0.04-0.15	0.30-3.00
		●	L	2	LS(M)	MP9015	20-75	0.06-0.20	0.20-1.00
		●	M	1	MS	MP9015	20-60	0.08-0.25	0.30-2.00
		●	M	2	RCMT-Std	MP9015	20-60	0.25-0.45	1.50-3.00
		✚	F	1	FJ	VP10RT	20-45	0.04-0.12	0.20-1.40
		✚	L	1	LS(M)	MP9025	15-25	0.06-0.20	0.20-1.00
		✚	M	1	MS	MP9025	15-20	0.08-0.25	0.30-2.00
		✚	M	2	RCMT-Std	MP9025	15-20	0.25-0.45	1.50-3.00

CUTTING CONDITIONS : ● : Stable Cutting ● : General Cutting ✚ : Unstable Cutting

CUTTING AREA : F : Finish Cutting L : Light Cutting M : Medium Cutting R : Rough Cutting H : Heavy Cutting

11° POSITIVE INSERT TYPE

Work Material	Hardness	Cutting Mode	Priority	Breaker	Grade	Cutting Speed (m/min)	Feed (mm/rev)	Depth of Cut (mm)	
Mild Steel (St37-2, Ck10)	≤180HB	●	F	1	R-R/L	NX2525	225-320	0.05-0.12	0.20-0.60
		●	L	1	R-Std	NX2525	185-270	0.08-0.30	0.30-2.00
		●	M	1	R-Std	NX2525	185-270	0.08-0.30	0.30-2.00
		●	F	1	R-R/L	NX2525	225-320	0.05-0.12	0.20-0.60
		●	L	1	R-Std	UE6110	210-355	0.08-0.30	0.30-2.00
		●	L	2	R-Std	MP3025	190-295	0.08-0.30	0.30-2.00
		●	L	3	R-Std	NX3035	180-255	0.08-0.30	0.30-2.00
		●	M	1	R-Std	UE6110	210-355	0.08-0.30	0.30-2.00
		●	M	2	R-Std	MP3025	190-295	0.08-0.30	0.30-2.00
		●	M	3	R-Std	NX3035	180-255	0.08-0.30	0.30-2.00
		⊕	F	1	R-R/L	UTi20T	115-165	0.05-0.12	0.20-0.60
		⊕	L	1	N-Flat	UP20M	105-160	0.08-0.30	0.30-2.00
		⊕	M	1	N-Flat	UP20M	105-160	0.08-0.30	0.30-2.00
		Carbon Steel • Alloy Steel (Ck45, 42CrMo4)	180 280HB	●	F	1	R-R/L	NX2525	165-240
●	L			1	R-Std	NX2525	140-200	0.08-0.30	0.30-2.00
●	M			1	R-Std	NX2525	140-200	0.08-0.30	0.30-2.00
●	F			1	R-R/L	NX2525	165-240	0.05-0.12	0.20-0.60
●	L			1	R-Std	UE6110	155-260	0.08-0.30	0.30-2.00
●	L			2	R-Std	MP3025	140-220	0.08-0.30	0.30-2.00
●	L			3	R-Std	NX3035	135-190	0.08-0.30	0.30-2.00
●	M			1	R-Std	UE6110	155-260	0.08-0.30	0.30-2.00
●	M			2	R-Std	MP3025	140-220	0.08-0.30	0.30-2.00
●	M			3	R-Std	NX3035	135-190	0.08-0.30	0.30-2.00
⊕	F			1	R-R/L	UTi20T	85-120	0.05-0.12	0.20-0.60
⊕	L			1	N-Flat	UP20M	80-120	0.08-0.30	0.30-2.00
⊕	M			1	N-Flat	UP20M	80-120	0.08-0.30	0.30-2.00

P

A
TURNING INSERTS

TURNING INSERTS

RECOMMENDED CUTTING CONDITIONS

■ 11° POSITIVE INSERT TYPE

Breaker : Std : Standard Flat : Flat Top

Work Material	Tensile Strength	Cutting Mode		Priority	Breaker	Grade	Cutting Speed (m/min)	Feed (mm/rev)	Depth of Cut (mm)
		Symbol	Code						
Gray Cast Iron (GG30)	≤350MPa	●	F	1	R-R/L	NX2525	145-200	0.05-0.12	0.20-0.60
		●	L	1	N-Flat	MC5005	165-265	0.08-0.30	0.30-2.00
		●	L	2	N-Flat	NX2525	120-165	0.08-0.30	0.30-2.00
		●	L	3	R-Std	NX2525	120-165	0.08-0.30	0.30-2.00
		●	M	1	N-Flat	MC5005	165-265	0.08-0.30	0.30-2.00
		●	M	2	N-Flat	NX2525	120-165	0.08-0.30	0.30-2.00
		●	M	3	R-Std	NX2525	120-165	0.08-0.30	0.30-2.00
		●	F	1	R-R/L	NX2525	145-200	0.05-0.12	0.20-0.60
		●	F	2	R-R/L	HTi10	100-140	0.05-0.12	0.20-0.60
		●	L	1	N-Flat	MC5015	150-240	0.08-0.30	0.30-2.00
		●	L	2	N-Flat	UE6110	125-200	0.08-0.30	0.30-2.00
		●	M	1	N-Flat	MC5015	150-240	0.08-0.30	0.30-2.00
		●	M	2	N-Flat	UE6110	125-200	0.08-0.30	0.30-2.00
		✚	F	1	R-R/L	UTi20T	80-115	0.05-0.12	0.20-0.60
		✚	L	1	N-Flat	VP15TF	115-160	0.08-0.30	0.30-2.00
✚	M	1	N-Flat	VP15TF	115-160	0.08-0.30	0.30-2.00		
Ductile Cast Iron (GGG40)	≤450MPa	●	F	1	R-R/L	NX2525	140-190	0.05-0.12	0.20-0.60
		●	L	1	N-Flat	MC5005	155-250	0.08-0.30	0.30-2.00
		●	L	2	N-Flat	NX2525	115-155	0.08-0.30	0.30-2.00
		●	L	3	R-Std	NX2525	115-155	0.08-0.30	0.30-2.00
		●	M	1	N-Flat	MC5005	155-250	0.08-0.30	0.30-2.00
		●	M	2	N-Flat	NX2525	115-155	0.08-0.30	0.30-2.00
		●	M	3	R-Std	NX2525	115-155	0.08-0.30	0.30-2.00
		●	F	1	R-R/L	NX2525	140-190	0.05-0.12	0.20-0.60
		●	F	2	R-R/L	HTi10	95-135	0.05-0.12	0.20-0.60
		●	L	1	N-Flat	MC5015	140-230	0.08-0.30	0.30-2.00
		●	L	2	N-Flat	UE6110	120-190	0.08-0.30	0.30-2.00
		●	M	1	N-Flat	MC5015	140-230	0.08-0.30	0.30-2.00
		●	M	2	N-Flat	UE6110	120-190	0.08-0.30	0.30-2.00
		✚	F	1	R-R/L	UTi20T	75-105	0.05-0.12	0.20-0.60
		✚	L	1	N-Flat	VP15TF	110-150	0.08-0.30	0.30-2.00
✚	M	1	N-Flat	VP15TF	110-150	0.08-0.30	0.30-2.00		
Ductile Cast Iron (GGG70)	≤800MPa	●	F	1	R-R/L	NX2525	125-170	0.05-0.12	0.20-0.60
		●	L	1	N-Flat	MC5005	140-225	0.08-0.30	0.30-2.00
		●	L	2	N-Flat	NX2525	105-140	0.08-0.30	0.30-2.00
		●	L	3	R-Std	NX2525	105-140	0.08-0.30	0.30-2.00
		●	M	1	N-Flat	MC5005	140-225	0.08-0.30	0.30-2.00
		●	M	2	N-Flat	NX2525	105-140	0.08-0.30	0.30-2.00
		●	M	3	R-Std	NX2525	105-140	0.08-0.30	0.30-2.00
		●	F	1	R-R/L	NX2525	125-170	0.05-0.12	0.20-0.60
		●	F	2	R-R/L	HTi10	85-120	0.05-0.12	0.20-0.60
		●	L	1	N-Flat	MC5015	125-205	0.08-0.30	0.30-2.00
		●	L	2	N-Flat	UE6110	105-170	0.08-0.30	0.30-2.00
		●	M	1	N-Flat	MC5015	125-205	0.08-0.30	0.30-2.00
		●	M	2	N-Flat	UE6110	105-170	0.08-0.30	0.30-2.00
		✚	F	1	R-R/L	UTi20T	65-95	0.05-0.12	0.20-0.60
		✚	L	1	N-Flat	VP15TF	95-135	0.08-0.30	0.30-2.00
✚	M	1	N-Flat	VP15TF	95-135	0.08-0.30	0.30-2.00		

CUTTING CONDITIONS : ● : Stable Cutting ● : General Cutting ✚ : Unstable Cutting

CUTTING AREA : F : Finish Cutting L : Light Cutting M : Medium Cutting R : Rough Cutting H : Heavy Cutting

Memo

A series of horizontal dashed lines for writing, spanning the width of the page.

TURNING INSERTS [NEGATIVE]

80° CN TYPE INSERTS WITH HOLE

CNMG 12 04 02- FP

Size Thickness Corner Radius Chipbreaker
* Please refer to page A002.

CHIP CONTROL RANGE FOR WORK MATERIALS

Finish Cutting..... Light Cutting..... Medium Cutting..... Rough Cutting..... Heavy Cutting.....

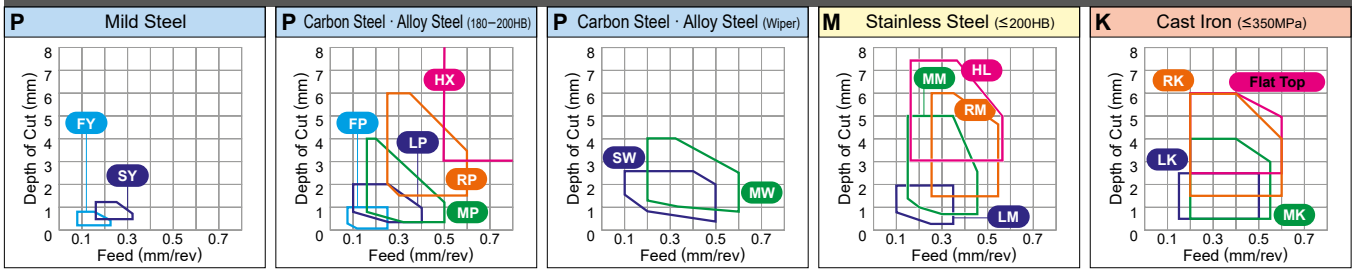

Cutting Conditions (Guide) : ● : Stable Cutting ● : General Cutting ✦ : Unstable Cutting









Shape	Order Number	RE (mm)	Coated																Cermet	Coated Cermet	Carbide	Applicable Holder / Page															
			UE6105	UE6110	UE6020	MC6115 NEW	MC6015	MC6025	MC6035	UH6400	MS6015	MC7015	MC7025	MP7035	US735	US905	MC5005	MC5015					MH515 NEW	MP9005	MP9015	MP9025 NEW	VP05RT	VP10RT	VP15TF	UP20M	NX2525	NX3035	MP3025	AP25N	VP25N	UT120T	HT110
FP 	CNMG120402-FP	0.2																																			C008
	CNMG120404-FP	0.4																																			C009
	CNMG120408-FP	0.8																																			E015
	CNMG120412-FP	1.2																																			E038
FH 	CNMG120402-FH	0.2																																		C008	
	CNMG120404-FH	0.4																																		C009	
	CNMG120408-FH	0.8																																		E015	
	CNMG120412-FH	1.2																																		E038	
FS 	CNMG120404-FS	0.4																																	C008		
	CNMG120408-FS	0.8																																		C009	
FY 	CNMG120404-FY	0.4																																		E015	
	CNMG120408-FY	0.8																																		E038	
																																				H006	
																																				-008	
FJ 	CNGG1204V5-FJ	0.05																																	C008		
	CNGG120401-FJ	0.1																																		C009	
	CNGG120402-FJ	0.2																																		E015	
	CNGG120404-FJ	0.4																																		E038	
	CNGG120408-FJ	0.8																																		H006	
LP 	CNMG120404-LP	0.4																																	C008		
	CNMG120408-LP	0.8																																	C009		
	CNMG120412-LP	1.2																																		E015	
LM 	CNMG120404-LM	0.4																																	C008		
	CNMG120408-LM	0.8																																	C009		
	CNMG120412-LM	1.2																																		E015	

● = NEW

● : Inventory maintained. ★ : Inventory maintained in Japan.

□ : Non stock, produced to order only.

Cutting Conditions (Guide) : ● : Stable Cutting ● : General Cutting ✳ : Unstable Cutting

Work Material	P	Steel	●●●●●●●●●●●●●●●●																																			
	M	Stainless Steel						●●●●●●●●●●●●●●●●																														
	K	Cast Iron							●●●●●●●●●●●●●●●●																													
N	Non-ferrous Metal								●●●●●●●●●●●●●●●●																													
	S	Heat-resistant Alloy, Titanium Alloy								●●●●●●●●●●●●●●●●																												
Shape	Order Number	RE (mm)	Coated														Cermet	Coated Cermet	Carbide	Applicable Holder Page																		
			UE6105	UE6110	UE6020	NEW MC6115	MC6015	MC6025	MC6035	UH6400	MS6015	MC7015	MC7025	MP7035	US735	US905	MC5005	MC5015	NEW MH515		MP9005	NEW MP9015	NEW MP9025	VP05RT	VP10RT	VP15TF	UP20M	NX2525	NX3035	MP3025	AP25N	VP25N	UT120T	HT110	RT9010	MT9015		
 Light Cutting	CNMG120404-LK	0.4														●●																						
	CNMG120408-LK	0.8														●●	●●	●●																				
	CNMG120412-LK	1.2														●●	●●	●●																				
 Light Cutting	CNMG090304-LS	0.4																	●●	●●	●●																	
	CNMG090308-LS	0.8																	●●	●●	●●																	
	CNMG120402-LS	0.2																	●●	●●	●●															●●		
	CNMG120404-LS	0.4																	●●	●●	●●															●●		
	CNMG120408-LS	0.8																	●●	●●	●●															●●		
 Light Cutting	CNMG09T304-SH	0.4	●											●																								
	CNMG09T308-SH	0.8	●																																			
	CNMG09T312-SH	1.2												□																								
	CNMG120404-SH	0.4	●●	●●	★	★	★	★							●									●●	★													
	CNMG120408-SH	0.8	●●	●●	★	★	★	★							●									●●	★													
	CNMG120412-SH	1.2	●●	●●	★	★	★	★						□										●●	★													
 Light Cutting	CNMG120404-SA	0.4	●●	●●	★	★	★	★																★★														
	CNMG120408-SA	0.8	●●	●●	★	★	●	★																★★														
	CNMG120412-SA	1.2	●●	●●	★	★	★	★																★														
*  Light Cutting (Wiper)	CNMG120404-SW	0.4	●●	●●	●●	★	★	●							●●									●●	★	★												
	CNMG120408-SW	0.8	●●	●●	●●	★	★	●							●●									●●	★	●												
	CNMG120412-SW	1.2	●●	●●	●●	★	★	●							●●									●●	★	★												
 Light Cutting	CNMG120404-SY	0.4			★																			●		★	●											
	CNMG120408-SY	0.8			●																			●		★	●											
 Light Cutting	CNMG120404-MJ	0.4													●						●●	●●														●		
	CNMG120408-MJ	0.8													●						●●	●●	●●													●		
	CNMG120412-MJ	1.2													●						●●	●●	●●													●		
	CNMG120416-MJ	1.6													●						●●	●●	★	●														
 Light Cutting	CNMG120404-MJ	0.4																																	●●	●●		
	CNMG120408-MJ	0.8																																	●●	●●		

* Please refer to page A028 before using the SW breaker (wiper insert).

● = NEW

TURNING INSERTS

A

NEG

WITH HOLE

C

D

R

S

T

V

W

TURNING INSERTS [NEGATIVE]

**CNMG 12 04 04- MP**Size Thickness Corner Radius Chipbreaker
★ Please refer to page A002.

CHIP CONTROL RANGE FOR WORK MATERIALS

Finish Cutting..... Light Cutting..... Medium Cutting..... Rough Cutting..... Heavy Cutting.....

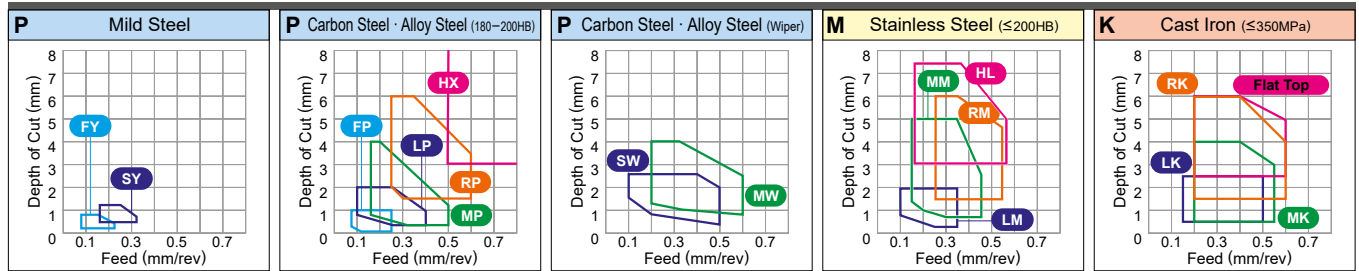

Cutting Conditions (Guide) : ● : Stable Cutting ● : General Cutting ✚ : Unstable Cutting

Work Material	Shape	Order Number	RE (mm)	Coated															Cermet	Coated Cermet	Carbide	Applicable Holder Page															
				UE6105	UE6110	UE6020	MC6115	MC6125	MC6015	MC6025	MC6035	UH6400	MS6015	MC7015	MC7025	MP7035	US735	US905					MC5005	MC5015	MH515	MP9005	MP9015	MP9025	VP05RT	VP10RT	VP15TF	UP20M	NX2525	NX3035	MP3025	AP25N	VP25N
P Steel	MP	CNMG120404-MP	0.4	● ●	● ●	● ●	● ●	● ●																					★								
		CNMG120408-MP	0.8	● ●	● ●	● ●	● ●	● ●																						●							C008
		CNMG120412-MP	1.2	● ●	● ●	● ●	● ●	● ●																						●							C009
M Stainless Steel	MP	CNMG120416-MP	1.6	★ ★	● ●	● ●	● ●	● ●																												E015	
		CNMG160608-MP	0.8	★ ●	★ ●	● ●																														E038	
		CNMG160612-MP	1.2	● ●	★ ●	● ●																														H006	
K Cast Iron	MP	CNMG160616-MP	1.6	● ★	★ ●	● ●																														-008	
		CNMG120408-MM	0.8						● ● ●																											C008	
		CNMG120412-MM	1.2						● ● ●																											C009	
N Non-ferrous Metal	MM	CNMG120416-MM	1.6						● ● ●																											E015	
		CNMG160608-MM	0.8						● ● ●																										E038		
		CNMG160612-MM	1.2						● ● ●																											H006	
S Heat-resistant Alloy, Titanium Alloy	MM	CNMG160616-MM	1.6						● ● ●																											-008	
		CNMG190608-MM	0.8						● ● ●																												
		CNMG190612-MM	1.2						● ● ●																												
S Heat-resistant Alloy, Titanium Alloy	MK	CNMG190616-MM	1.6						● ● ●																												
		CNMG120404-MK	0.4													● ●																				C008	
		CNMG120408-MK	0.8													● ●																				C009	
S Heat-resistant Alloy, Titanium Alloy	MK	CNMG120412-MK	1.2												● ●																					E015	
		CNMG120416-MK	1.6												★ ●																				E038		
		CNMG160608-MK	0.8												★ ●																					H006	
S Heat-resistant Alloy, Titanium Alloy	MK	CNMG160612-MK	1.2												● ●																						
		CNMG160616-MK	1.6												● ●																					-008	
		CNMG190612-MK	1.2												★ ●																						
S Heat-resistant Alloy, Titanium Alloy	MS	CNMG190616-MK	1.6												★ ●																						
		CNMG090304-MS	0.4																	● ● ●																C008	
		CNMG090308-MS	0.8																	● ● ●																C009	
S Heat-resistant Alloy, Titanium Alloy	MS	CNMG120404-MS	0.4																	● ● ●													●			E015	
		CNMG120408-MS	0.8																	● ● ●												●			E038		
		CNMG120412-MS	1.2																	● ● ●												●				H006	
S Heat-resistant Alloy, Titanium Alloy	MS	CNMG160612-MS	1.2																	★ ● ●												★				-008	
		CNMG160616-MS	1.6																	★ ★												★					

*Newly designed breakers : MP9005, MP9015, MP9025, MT9015

● = NEW

● : Inventory maintained. ★ : Inventory maintained in Japan.

□ : Non stock, produced to order only.

TURNING INSERTS [NEGATIVE]

80° CN TYPE INSERTS WITH HOLE

CNMG 09 03 08

Size Thickness Corner Radius

* Please refer to page A002.

CHIP CONTROL RANGE FOR WORK MATERIALS

Finish Cutting..... Light Cutting..... Medium Cutting..... Rough Cutting..... Heavy Cutting.....

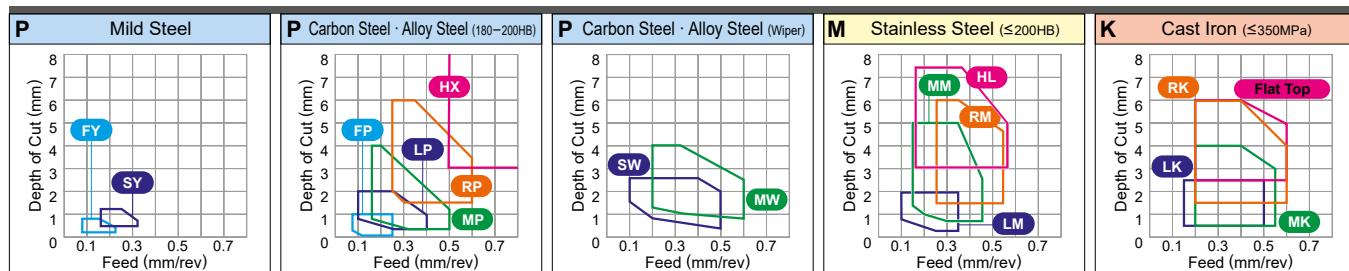

Cutting Conditions (Guide) : ● : Stable Cutting ● : General Cutting ☆ : Unstable Cutting

Work Material			Coated																			Cermet	Coated Cermet		Carbide			Applicable Holder Page											
	P	M	UE6105	UE6110	UE620	MC6115 NEW	MC6015	MC6025	MC6035	UH6400	MS6015	MC7015	MC7025	MP7035	US735	US905	MC5005	MC5015	MH515 NEW	MP9005	MP9015		MP9025 NEW	VP05RT	VP10RT	VP15TF	UP20M		NX2525	NX3035	MP3025	AP25N	VP25N	UT120T	HT110	RT9010	MT9015		
Standard	CNMG090308		0.8	★																																			
	CNMG09T304		0.4	●			●	●																				●											
	CNMG09T308		0.8	●			●	●																				★											
	CNMG120404		0.4	●	●	●	●	●																				●	★	★			●	●					
	CNMG120408		0.8	●	●	●	●	●	●																			●				★		●	●				
	CNMG120412		1.2	●	●	●	●	●	●																			★					●						
	CNMG120416		1.6	★	★	●	●	●																															
	CNMG160608		0.8	●	★	●	●	●	●																														
	CNMG160612		1.2	★	●	●	●	●	●																												●		
	CNMG160616		1.6	★	★	●	●	●	●																														
	CNMG190608		0.8	★	●	●	●	●	●																														
CNMG190612		1.2	★	★	●	●	●	●																															
CNMG190616		1.6	●	★	●	●	●	●																															
* MW		CNMG120408-MW		0.8	●	●	●	●	●								●	●																					
		CNMG120412-MW		1.2	●	●	●	●	●								●	●																					
Medium Cutting (Wiper)																																							
RP		CNMG120408-RP		0.8	●	●	●	●	●																														
		CNMG120412-RP		1.2	●	●	●	●	●																														
		CNMG120416-RP		1.6	★	★	●	●	●																														
		CNMG160612-RP		1.2	●	★	●	●	●																														
		CNMG160616-RP		1.6	●	★	●	●	●																														
		CNMG190612-RP		1.2	★	★	●	●	●																														
Rough Cutting		CNMG190616-RP		1.6	★	●	●	●	●																														
RM		CNMG120408-RM		0.8								●	●	●																									
		CNMG120412-RM		1.2								●	●	●																									
		CNMG120416-RM		1.6								●	●	●																									
		CNMG160612-RM		1.2								●	●	●																									
		CNMG160616-RM		1.6								●	●	●																									
		CNMG190612-RM		1.2								●	●	●																									
Rough Cutting		CNMG190616-RM		1.6								●	●	●																									

* Please refer to page A028 before using the MW breaker (wiper insert).

● = NEW

● : Inventory maintained. ★ : Inventory maintained in Japan.

□ : Non stock, produced to order only.



55° DN TYPE INSERTS WITH HOLE

DNMG 15 04 02- FP

Size Thickness Corner Radius Chipbreaker
* Please refer to page A002.

CHIP CONTROL RANGE FOR WORK MATERIALS

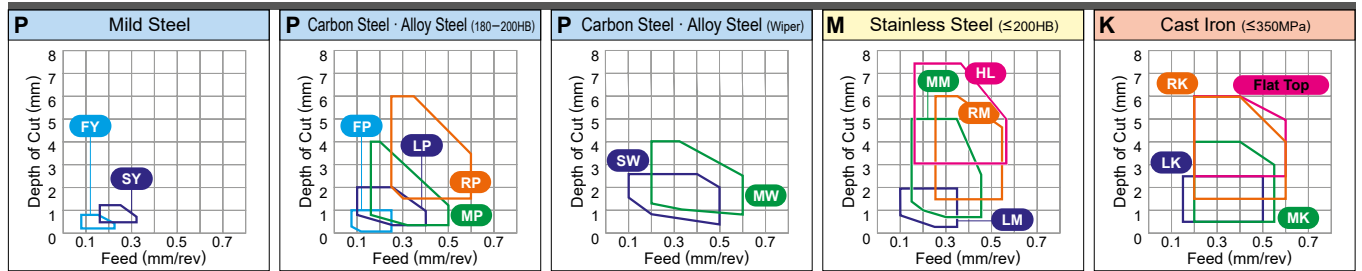

Cutting Conditions (Guide) : ●: Stable Cutting ●: General Cutting ✚: Unstable Cutting

Work Material	Shape	Order Number	RE (mm)	Coated												Cermet	Coated Cermet	Carbide			Applicable Holder / Page																		
				UE6105	UE6110	UE6020	NEW MC6115	MC6015	MC6025	MC6035	UH6400	MS6015	MC7015	MC7025	MP7035	US735	US905	MC5005	MC5015	NEW MH515		MP9005	NEW MP9015	NEW MP9025	VP05RT	VP10RT	VP15TF	UP20M	NX2525	NX3035	MP3025	AP25N	VP25N	UT120T	HT110	RT9010	MT9015		
FP 	Finish Cutting	DNMG150402-FP	0.2																																				
		DNMG150404-FP	0.4																																				C010
		DNMG150408-FP	0.8																																				C011
		DNMG150412-FP	1.2																																				E015
		DNMG150602-FP	0.2																																				E038
		DNMG150604-FP	0.4																																				-040
		DNMG150608-FP	0.8																																				H009
		DNMG150612-FP	1.2																																		-011		
FH 	Finish Cutting	DNMG150402-FH	0.2	★																																	C010		
		DNMG150404-FH	0.4	●																																	C011		
		DNMG150408-FH	0.8	●																																		E015	
		DNMG150602-FH	0.2	★																																		E038	
		DNMG150604-FH	0.4	●																																		-040	
		DNMG150608-FH	0.8	●																																		H009	
FS 	Finish Cutting	DNMG150404-FS	0.4																																	C010			
		DNMG150408-FS	0.8																																		C011		
		DNMG150604-FS	0.4																																		E015		
		DNMG150608-FS	0.8																																		E038		
FY 	Finish Cutting	DNMG150404-FY	0.4	★																																-040			
		DNMG150408-FY	0.8	★																																H009			
		DNMG150604-FY	0.4																																	-011			
		DNMG150608-FY	0.8	●																																			
FJ 	Finish Cutting	DNGG150404-FJ	0.4																																C010				
		DNGG150408-FJ	0.8																																C011				

● = NEW

CHIPBREAKERS > A042
GRADES > A030
IDENTIFICATION > A002

TURNING INSERTS [NEGATIVE]

DNMG 11 04 04- LP

 Size Thickness Corner Radius Chipbreaker
 * Please refer to page A002.

CHIP CONTROL RANGE FOR WORK MATERIALS

Finish Cutting..... Light Cutting..... Medium Cutting..... Rough Cutting..... Heavy Cutting.....

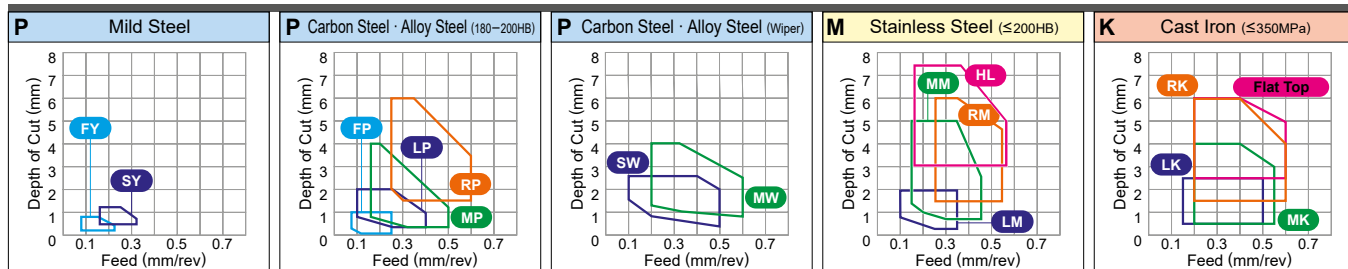
Cutting Conditions (Guide) : ●: Stable Cutting ●: General Cutting ✦: Unstable Cutting

Work Material	Shape	Order Number	RE (mm)	Coated														Cermet	Coated Cermet	Carbide	Applicable Holder / Page																								
				UE6105	UE6110	UE6020	NEW MC6115	MC6015	MC6025	MC6035	UH6400	MS6015	MC7015	MC7025	MP7035	US735	US905					MC5005	MC5015	NEW MH515	NEW MP9005	NEW MP9025	VP05RT	VP10RT	VP15TF	UP20M	NX2525	NX3035	MP3025	AP25N	VP25N	UT120T	HT110	RT9010	MT9015						
Mild Steel (P)		DNMG110404-LP	0.4	●●	●●	●●	●●	●●	●●	●●	●●	●●	●●	●●	●●																														
		DNMG110408-LP	0.8	●★			●●	●●	●●																			●														C010			
		DNMG150404-LP	0.4	●●	●●	●●	●●	●●	●●	●●																		●															C011		
		DNMG150408-LP	0.8	●●	●●	●●	●●	●●	●●	●●																		★														E015			
		DNMG150412-LP	1.2	★★	●●	●●	●●	●●	●●	●●																		★														E038			
		DNMG150604-LP	0.4	●●	●●	●●	●●	●●	●●	●●																		●														-040			
		DNMG150608-LP	0.8	●●	●●	●●	●●	●●	●●	●●																		●														H009			
		DNMG150612-LP	1.2	★●	●●	●●	●●	●●	●●	●●																																-011			
Light Cutting		DNMG110404-LM	0.4							●●	●●	●●																													C010				
		DNMG110408-LM	0.8							●●	●●	●●																														C011			
		DNMG150404-LM	0.4							●●	●●	●●	★																													E015			
		DNMG150408-LM	0.8							●●	●●	●●	★																													E038			
		DNMG150412-LM	1.2							★★	★★	★★																														-040			
		DNMG150604-LM	0.4							●●	●●	●●																														H009			
		DNMG150608-LM	0.8							●●	●●	●●																															-011		
		DNMG150612-LM	1.2							★★	★★	★★																																	
Light Cutting		DNMG110408-LK	0.8													★●																									C010				
		DNMG150404-LK	0.4														●●	★																								C011			
		DNMG150408-LK	0.8														●●																										E015		
		DNMG150412-LK	1.2														★★																										E038		
		DNMG150604-LK	0.4														●●																										-040		
		DNMG150608-LK	0.8														●●																										H009		
		DNMG150612-LK	1.2														●●																										-011		
		Light Cutting		DNMG150402-LS	0.2														●●	●●																								C010	
DNMG150404-LS	0.4																	●●	●●																								C011		
DNMG150408-LS	0.8																	●●	●●																									E015	
DNMG150604-LS	0.4																	●●	●●																									E038	
DNMG150608-LS	0.8																	●●	●●																									-040	
DNMG150612-LS	1.2																	●●	●●																									H009	
Light Cutting				DNMG110404-SH	0.4	●●								●														●																	C010
				DNMG110408-SH	0.8	●●									●														●																
		DNMG150404-SH	0.4	★●	★★	★★	★★	★★					●														●★		★															E015	
		DNMG150408-SH	0.8	★●	★★	★★	★★	★★					●														●★		★															E038	
		DNMG150412-SH	1.2	★★	★★	★★	★★	★★					★														★		★															-040	
		DNMG150604-SH	0.4	●●	★★	★★																																						H009	
		DNMG150608-SH	0.8	●●	★★	★★																																							-011
		DNMG150612-SH	1.2	★●	★★									●																															

● = NEW

● : Inventory maintained. ★ : Inventory maintained in Japan.

TURNING INSERTS [NEGATIVE]

 90° **SN** TYPE INSERTS WITH HOLE

SNGG 09 03 04 R
 Size Thickness Corner Radius R/L
 * Please refer to page A002.

CHIP CONTROL RANGE FOR WORK MATERIALS

Finish Cutting..... Light Cutting..... Medium Cutting..... Rough Cutting..... Heavy Cutting.....

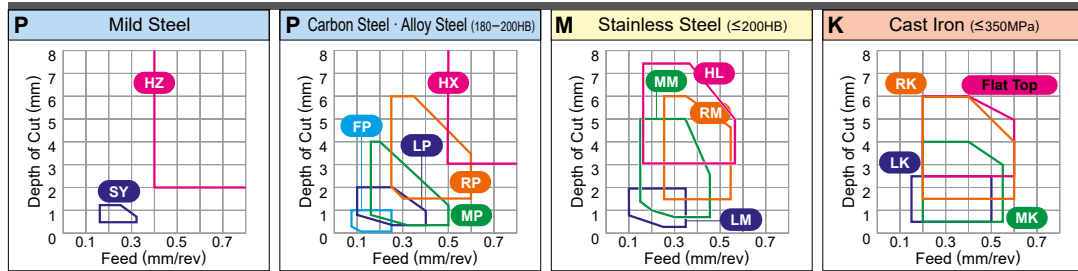

Cutting Conditions (Guide) : ● : Stable Cutting ● : General Cutting ✦ : Unstable Cutting

Work Material	Shape	Order Number	RE (mm)	Coated													Cermets	Coated Cermets	Carbide	Applicable Holder Page																		
				UE6105	UE6110	UE6020	NEW MC6115	MC6015	MC6025	MC6035	UH6400	MS6015	MC7015	MC7025	MP7035	US735					US905	MC5005	MC5015	NEW MH515	NEW MP9005	NEW MP9015	NEW MP9025	VP05RT	VP10RT	VP15TF	UP20M	NX2525	NX3035	MP3025	AP25N	VP25N	UT120T	HT110
P Steel	R/L	SNGG090304R	0.4	●●●●●●●●																							●●●●●●											
		SNGG090304L	0.4																																			
		SNGG090308R	0.8																																			
		SNGG090308L	0.8																																			
		SNGG120404R	0.4																																			
		SNGG120404L	0.4																																			
		SNGG120408R	0.8																																			
M Stainless Steel	Medium Cutting	SNGG120408L	0.8																																			
		RP	SNMG120408-RP	0.8	★ ★	● ● ● ● ● ● ● ●																																
			SNMG120412-RP	1.2	★ ●	● ● ● ● ● ● ● ●																																
			SNMG120416-RP	1.6	★ ★	● ● ● ● ● ● ● ●																																
			SNMG150612-RP	1.2	★ ★	● ● ● ● ● ● ● ●																																
			SNMG150616-RP	1.6	● ★	● ● ● ● ● ● ● ●																																
			SNMG190612-RP	1.2	★ ★	● ● ● ● ● ● ● ●																																
SNMG190616-RP	1.6	★ ●	● ● ● ● ● ● ● ●																																			
K Cast Iron	Rough Cutting	SNMG120408-RM	0.8							★ ● ●																												
		SNMG120412-RM	1.2							★ ● ●																												
		SNMG120416-RM	1.6							★ ★ ●																												
		SNMG150612-RM	1.2							● ★ ●																												
		SNMG150616-RM	1.6							★ ★ ★																												
		SNMG190612-RM	1.2							★ ● ★																												
		SNMG190616-RM	1.6							● ● ●																												
S Heat-resistant Alloy, Titanium Alloy	Rough Cutting	SNMG120408-RK	0.8															● ●																				
		SNMG120412-RK	1.2																● ●																			
		SNMG120416-RK	1.6																● ●																			
		SNMG150612-RK	1.2																★ ●																			
		SNMG150616-RK	1.6																★ ●																			
		SNMG190612-RK	1.2																★ ●																			
		SNMG190616-RK	1.6																★ ●																			
N Non-ferrous Metal	Rough Cutting	SNMG120408-RS	0.8																																●			
		SNMG120412-RS	1.2																																●			
		SNMG120416-RS	1.6																																	★		
		SNMG150616-RS	1.6																																	★		
		SNMG190612-RS	1.2																																	★		
		SNMG190616-RS	1.6																																	★		

● = NEW

● : Inventory maintained. ★ : Inventory maintained in Japan.

□ : Non stock, produced to order only.

TURNING INSERTS [NEGATIVE]



SNMM 25 07 24- HXD

Size Thickness Corner Radius Chipbreaker
* Please refer to page A002.

CHIP CONTROL RANGE FOR WORK MATERIALS

Finish Cutting..... Light Cutting..... Medium Cutting..... Rough Cutting..... Heavy Cutting.....

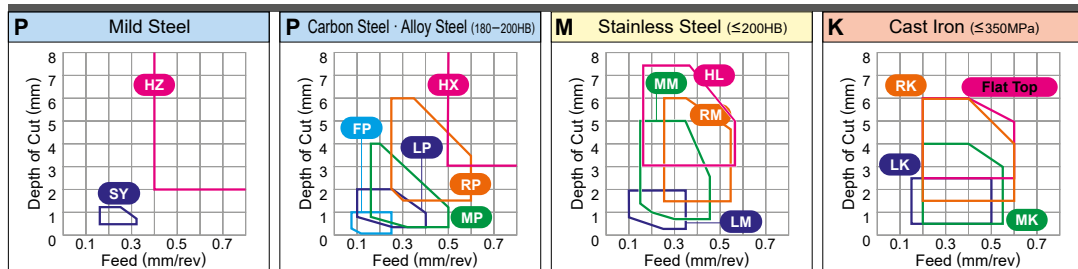

Cutting Conditions (Guide) : ● : Stable Cutting ● : General Cutting ✦ : Unstable Cutting

Work Material	Order Number		RE (mm)	Coated														Cermet	Coated Cermet		Carbide			Applicable Holder Page																
	P	M		UE6105	UE6110	UE6020	MC6115 NEW	MC6015	MC6025	MC6035	UH6400	MS6015	MC7015	MC7025	MP7035	US735	US905		MC5005	MC5015	MH515 NEW	MP9005	MP9015		MP9025 NEW	VP05RT	VP10RT	VP15TF	UP20M	NX2525	NX3035	MP3025	AP25N	VP25N	UTi20T	HTi10	RT9010	MT9015		
Steel	●	●		●	●	●	●	●	●	●	●	●	●	●	●	●	●	●	●	●	●	●	●	●	●	●	●	●	●	●	●	●	●	●	●	●	●	●	●	
Stainless Steel	●	●		●	●	●	●	●	●	●	●	●	●	●	●	●	●	●	●	●	●	●	●	●	●	●	●	●	●	●	●	●	●	●	●	●	●	●	●	
Cast Iron	●	●		●	●	●	●	●	●	●	●	●	●	●	●	●	●	●	●	●	●	●	●	●	●	●	●	●	●	●	●	●	●	●	●	●	●	●	●	
Non-ferrous Metal	●	●		●	●	●	●	●	●	●	●	●	●	●	●	●	●	●	●	●	●	●	●	●	●	●	●	●	●	●	●	●	●	●	●	●	●	●	●	
Heat-resistant Alloy, Titanium Alloy	●	●		●	●	●	●	●	●	●	●	●	●	●	●	●	●	●	●	●	●	●	●	●	●	●	●	●	●	●	●	●	●	●	●	●	●	●	●	
HXD Heavy Cutting	SNMM250724-HXD	2.4																																						
	Flat Top 	SNMA090304	0.4																																					
	SNMA090308	0.8																																						
	SNMA120408	0.8																																						
	SNMA120412	1.2																																						
	SNMA120416	1.6																																						
	SNMA150612	1.2																																						
	SNMA150616	1.6																																						
	SNMA190612	1.2																																						
	SNMA190616	1.6																																						
Flat Top 	SNGA090304	0.4																																						
	SNGA120404	0.4																																						
	SNGA120408	0.8																																						

● = NEW

● : Inventory maintained. ★ : Inventory maintained in Japan.

TURNING INSERTS

NEG WITH HOLE

C

D

R

S

T

V

W



TN TYPE INSERTS WITH HOLE

TNMG 16 04 02- FP

Size Thickness Corner Radius Chipbreaker
 * Please refer to page A002.

CHIP CONTROL RANGE FOR WORK MATERIALS

Finish Cutting..... Light Cutting..... Medium Cutting..... Rough Cutting..... Heavy Cutting.....

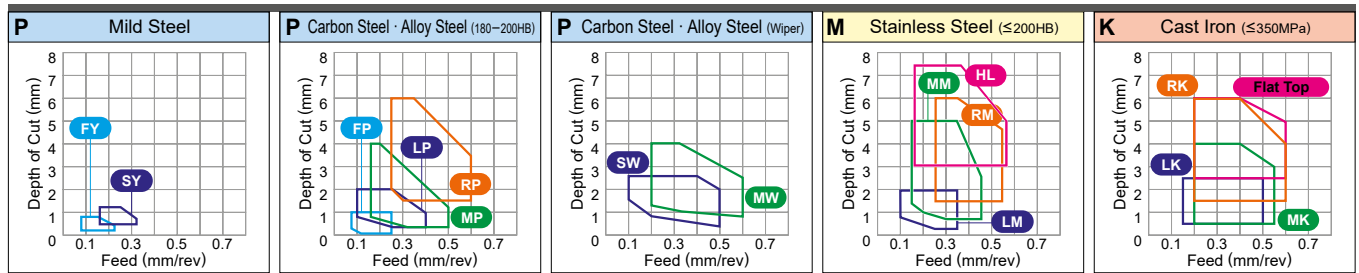

Cutting Conditions (Guide) : ● : Stable Cutting ● : General Cutting ⊕ : Unstable Cutting

Work Material	P	Steel	● ● ● ⊕ ⊕ ⊕ ⊕ ⊕ ⊕ ●																																	
	M	Stainless Steel									● ● ● ⊕ ⊕ ⊕ ●																									
K	Cast Iron																																			
N	Non-ferrous Metal																																			
S	Heat-resistant Alloy, Titanium Alloy											●																								
Shape	Order Number	RE (mm)	Coated										Cermet	Coated Cermet		Carbide			Applicable Holder / Page																	
			UE6105	UE6110	UE6020	MC6115 <small>NEW</small>	MC6015	MC6025	MC6035	UH6400	MS6015	MC7015	MC7025	MP7035	US735	US905	MC5005	MC5015		MH515 <small>NEW</small>	MP9005	MP9015	MP9025 <small>NEW</small>	VP05RT	VP10RT	VP15TF	UP20M	NX2525	NX3035	MP3025	AP25N	VP25N	UT120T	HT110	RT9010	MT9015
FP 	TNMG160402-FP	0.2										★ ★																								
	TNMG160404-FP	0.4										● ●																								C016
	TNMG160408-FP	0.8										● ●																								-018
	TNMG160412-FP	1.2										● ●																								E016
FH 	TNMG110304-FH	0.4																									★								C016	
	TNMG160402-FH	0.2	★																								★ ★								-018	
	TNMG160404-FH	0.4	●																								● ★	● ★							E016	
	TNMG160408-FH	0.8	●																								★ ●	★ ★							E037	
FS 	TNMG160404-FS	0.4																									●								C016	
	TNMG160408-FS	0.8																										●								-018
FY 	TNMG160404-FY	0.4																									★ ●	● ●							C016	
	TNMG160408-FY	0.8																										★	★	●						-018
R/L-FS 	TNGG160402R-FS	0.2										●															★								C016	
	TNGG160402L-FS	0.2										●																★								-018
	TNGG160404R-FS	0.4										●																★								E016
	TNGG160404L-FS	0.4										●																★								E037
	<small>NEW</small> TNGG160408R-FS	0.8										●																								
	<small>NEW</small> TNGG160408L-FS	0.8										●																								
R/L-F 	TNGG160402R-F	0.2																								●	★ ●	★								C016
	TNGG160402L-F	0.2																									★	★ ★	★							-018
	TNGG160404R-F	0.4																									●	★ ●	★							E016
	TNGG160404L-F	0.4																									●	★ ●	★							E037
	TNGG160408R-F	0.8																									★	★ ★	★							
TNGG160408L-F	0.8																									★	★ ★	★								

● = NEW

A

TURNING INSERTS

NEG
WITH HOLE

C

D

R

S

T

V

W

CHIPBREAKERS > A042
 GRADES > A030
 IDENTIFICATION > A002

TURNING INSERTS [NEGATIVE]



TN TYPE INSERTS WITH HOLE

TNMG 16 04 04- LP

Size Thickness Corner Radius Chipbreaker
* Please refer to page A002.

CHIP CONTROL RANGE FOR WORK MATERIALS

Finish Cutting..... Light Cutting..... Medium Cutting..... Rough Cutting..... Heavy Cutting.....

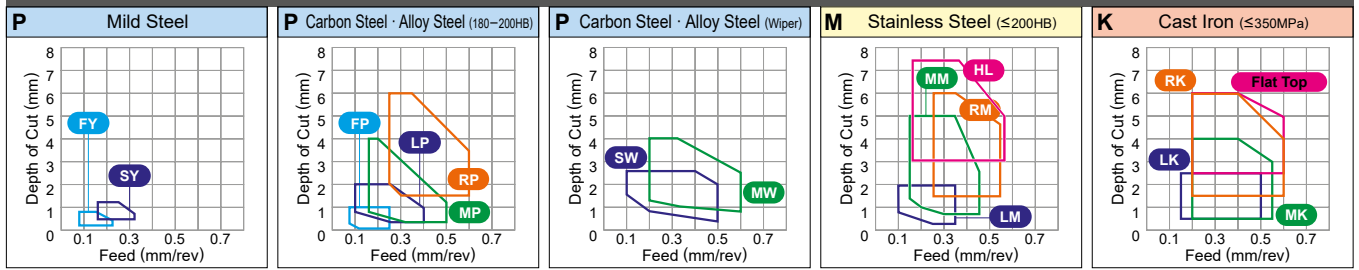

TURNING INSERTS

NEG

WITH HOLE

Cutting Conditions (Guide) : ● : Stable Cutting ● : General Cutting ☆ : Unstable Cutting









Work Material	P Steel	M Stainless Steel	K Cast Iron	N Non-ferrous Metal	S Heat-resistant Alloy, Titanium Alloy	Coated														Cermat	Coated Cermat		Carbide	Applicable Holder Page															
						UE6105	UE6110	UE6020	NEW MC6115	MC6015	MC6025	MC6035	UH6400	MS6015	MC7015	MC7025	MP7035	US735	US905		MC5005	MC5015			NEW MH515	MP9005	NEW MP9015	NEW MP9025	VP05RT	VP-10RT	VP-15TF	UP20M	NX2525	NX3035	MP3025	AP25N	VP25N	UT120T	HT110
LP 	TNMG160404-LP	0.4	● ☆	● ● ● ●																																			
	TNMG160408-LP	0.8	● ●	● ● ● ●																						●												C016	
	TNMG160412-LP	1.2	● ☆	● ● ● ●																						●												—018	
	TNMG220408-LP	0.8	★ ★	● ● ● ●																						★												E016	
LM 	TNMG160404-LM	0.4							● ● ●																													C016	
	TNMG160408-LM	0.8							★ ● ●																													—018	
	TNMG160412-LM	1.2							★ ★ ★																													E016	
LK 	TNMG160404-LK	0.4														● ●																						C016	
	TNMG160408-LK	0.8														● ●																						—018	
	TNMG160412-LK	1.2														★ ●																						E016	
LS 	TNMG160402-LS	0.2																	● ● ●																			C016	
	TNMG160404-LS	0.4																	● ● ●																			—018	
	TNMG160408-LS	0.8																	● ● ●																			E016	
SH 	TNMG160404-SH	0.4	● ●	★ ★ ★ ★					●											● ●	★																	C016	
	TNMG160408-SH	0.8	★ ●	★ ★ ★ ★					●											● ●	★																	—018	
	TNMG220408-SH	0.8	● ★	★ ★					★																													E016	
SA 	TNMG160404-SA	0.4	● ●	★ ★ ★ ★																★ ●																		C016	
	TNMG160408-SA	0.8	● ●	★ ★ ★ ★																★ ●																		—018	
	TNMG160412-SA	1.2	● ●	★ ●																	★																	E016	
	TNMG220408-SA	0.8	★ ●	● ★																																		E037	
	TNMG220412-SA	1.2	●																																				
* SW 	TNMX160404-SW	0.4	● ★		●															● ★ ●																			
	TNMX160408-SW	0.8	● ●		●																● ★ ★																		C017
																																					—018		

* Please refer to page A028 before using the SW breaker (wiper insert).

● = NEW

● : Inventory maintained. ★ : Inventory maintained in Japan.

Cutting Conditions (Guide) : ● : Stable Cutting ◐ : General Cutting ✪ : Unstable Cutting

Work Material	P Steel		M Stainless Steel		K Cast Iron		N Non-ferrous Metal		S Heat-resistant Alloy, Titanium Alloy																															
	Coated											Cermet	Coated Cermet	Carbide	Applicable Holder Page																									
	Shape	Order Number	RE (mm)	UE6105	UE6110	UE6020	MC6115 NEW	MC6015	MC6025	MC6035	UH6400	MS6015	MC7015	MC7025		MP7035	US735	US905	MC5005	MC5015	MH515 NEW	MP9005	MP9015	MP9025 NEW	VP05RT	VP10RT	VP15TF	UP20M	NX2525	NX3035	MP3025	AP25N	VP25N	UT120T	HT110	RT9010	MT9015			
SY  Light Cutting	TNMG160404-SY	0.4	●	●	●	●	●	●	●	●	●	●	●	●		●	●	●	●	●	●	●	●	●	●	●	●	●	●	●	●	●	●	●	●	●	●	●	●	C016 -018 E016 E037
	TNMG160408-SY	0.8	●	●	●	●	●	●	●	●	●	●	●	●	●	●	●	●	●	●	●	●	●	●	●	●	●	●	●	●	●	●	●	●	●	●	●	●	●	
MJ  Light Cutting	TNMG160404-MJ	0.4														●		●	●		●	●		●	●												●	C016 -018 E016 E037		
	TNMG160408-MJ	0.8														●		●	●		●	●		●	●												●			
	TNMG160412-MJ	1.2														●		●	●		●	●		●	●		●	●											●	
R/L-K  Light Cutting	TNGG160402R-K	0.2																										★	★	★									C016 -018 E016 E037	
	TNGG160402L-K	0.2																										★	★	★										
	TNGG160404R-K	0.4																										★	★	★										
	TNGG160404L-K	0.4																										★	★	★										
	TNGG160408R-K	0.8																											★	★	★									
MP  Medium Cutting	TNMG160404-MP	0.4	●	●	●	●	●	●	●																				★									C016 -018 E016 E037		
	TNMG160408-MP	0.8	●	●	●	●	●	●	●																				●											
	TNMG160412-MP	1.2	●	★	●	●	●	●	●																				★											
	TNMG220408-MP	0.8	★	●	●	●	●	●	●																															
	TNMG220412-MP	1.2	★	★	●	●	●	●	●																															
MM  Medium Cutting	TNMG160408-MM	0.8										●	●	●																									C016 -018 E016 E037	
	TNMG160412-MM	1.2										★	★	★																										
	TNMG220408-MM	0.8										★	●	★																										
	TNMG220412-MM	1.2										★	★	★																										
	TNMG220416-MM	1.6										★	●	★																										
MK  Medium Cutting	TNMG160404-MK	0.4															●	●																					C016 -018 E016 E037	
	TNMG160408-MK	0.8															●	●																						
	TNMG160412-MK	1.2															●	●																						
	TNMG220408-MK	0.8															★	●																						
	TNMG220412-MK	1.2															★	★																						
* MS  Medium Cutting	TNMG160404-MS	0.4																	●	●	●	●															●	C016 -018 E016 E037		
	TNMG160408-MS	0.8																	●	●	●	●																	●	
	TNMG160412-MS	1.2																	●	●	●	●																	★	
	TNMG220408-MS	0.8																	●	●	●	●																	★	
	TNMG220412-MS	1.2																	●	●	●	●																	★	
MS  Medium Cutting	TNMG160404-MS	0.4	●												●	★											●	●	●							★			C016 -018 E016 E037	
	TNMG160408-MS	0.8	★												●	★										●	●	●	★		★						●			
	TNMG160412-MS	1.2	★												●	●										★	●													
	TNMG220408-MS	0.8	★												●	★										★	●	●	★											
	TNMG220412-MS	1.2													●																									
GK  Medium Cutting	TNMG160404-GK	0.4															●	●																				C016 -018 E016 E037		
	TNMG160408-GK	0.8															●	●																						
	TNMG160412-GK	1.2															●	●	★																					
	TNMG220408-GK	0.8															★	●																						
	TNMG220412-GK	1.2															★	★																						

*Newly designed breakers : MP9005, MP9015, MP9025, MT9015

● = NEW

TURNING INSERTS [NEGATIVE]



TN TYPE INSERTS WITH HOLE

TNMG 16 04 08- RK

Size Thickness Corner Radius Chipbreaker
* Please refer to page A002.

CHIP CONTROL RANGE FOR WORK MATERIALS

Finish Cutting..... Light Cutting..... Medium Cutting..... Rough Cutting..... Heavy Cutting.....

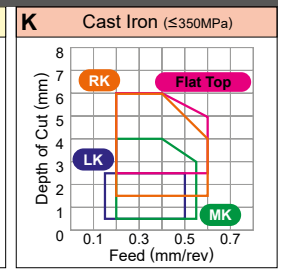
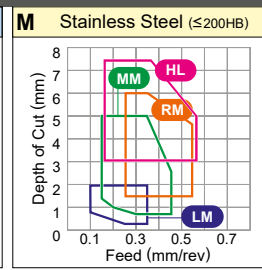
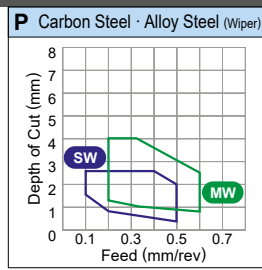
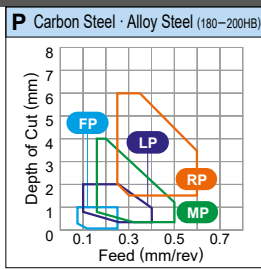
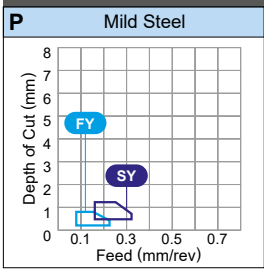

TURNING INSERTS

A

NEG

WITH HOLE

C

D

R

S

T

V

W

Cutting Conditions (Guide) : ● : Stable Cutting ● : General Cutting ✦ : Unstable Cutting

Work Material	Shape	Order Number	RE (mm)	Coated																		Cermet	Coated Cermet	Carbide		Applicable Holder / Page															
				UE6105	UE6110	UE620	NEW MC6115	MC6015	MC6025	MC6035	UH6400	MS6015	MC7015	MC7025	MP7035	US735	US905	MC5005	MC5015	NEW MH515	NEW MP9005			NEW MP9015	NEW MP9025		VP05RT	VP10RT	VP15TF	UP20M	NX2525	NX3035	MP3025	AP25N	VP25N	UT120T	HT110	RT9010	MT9015		
																																								✦	●
RK	Rough Cutting	TNMG160408-RK	0.8	●	●	●	●	●	●	●	●	●	●	●	●	●	●	●	●	●	●	●	●	●	●	●	●	●	●	●	●	●	●	●	●	●	●	●			
		TNMG160412-RK	1.2															●	●																						C016
		TNMG160416-RK	1.6															●	●																						—018
		TNMG220408-RK	0.8															●	●																						E016
		TNMG220412-RK	1.2															●	●																						E037
RS	Rough Cutting	TNMG220416-RK	1.6													●	●																								
RS	Rough Cutting	TNMG160408-RS	0.8															●	●																		●				
		TNMG160412-RS	1.2																●	●																	●		C016		
		TNMG220408-RS	0.8																●	●																★	★		E016		
		TNMG220412-RS	1.2																●	●															★	★			E037		
GH	Rough Cutting	TNMG160408-GH	0.8	★	●	★	★					●																													
		TNMG160412-GH	1.2	★	●	★	★					●																													
		TNMG220408-GH	0.8	★	★	★	★					●																													
		TNMG220412-GH	1.2	★	●	★	★					●																													
		TNMG220416-GH	1.6	★	●	★	★					●																													
		TNMG270612-GH	1.2	★	★	★	★					★																													
GH	Rough Cutting	TNMG270616-GH	1.6	★	★	★	★																																		
HL	Heavy Cutting	TNMM160408-HL	0.8	●				●	●			★																													
		TNMM160412-HL	1.2	●					●	●			★																												
		TNMM220408-HL	0.8	●					●	●			●																												
		TNMM220412-HL	1.2	●					●	●			●																												
		TNMM220416-HL	1.6	●					●	●			●																												
HZ	Heavy Cutting	TNMM160408-HZ	0.8	★				★	★																																
		TNMM160412-HZ	1.2	★					★	★																															
		TNMM220408-HZ	0.8	★						★	★																														
		TNMM220412-HZ	1.2	★						★	★																														
HZ	Heavy Cutting	TNMM220416-HZ	1.6	★					★																																

● = NEW

● : Inventory maintained. ★ : Inventory maintained in Japan.

TURNING INSERTS [NEGATIVE]



35° VN TYPE INSERTS WITH HOLE

VNMG 16 04 02- FP

Size Thickness Corner Radius Chipbreaker
 * Please refer to page A002.

TURNING INSERTS

NEG

WITH HOLE

C

D

R

S

T

V

W

CHIP CONTROL RANGE FOR WORK MATERIALS

Finish Cutting..... Light Cutting..... Medium Cutting..... Rough Cutting..... Heavy Cutting.....

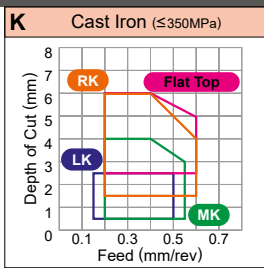
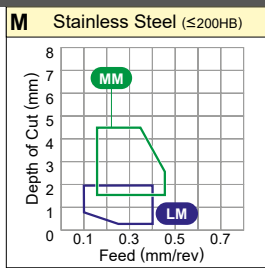
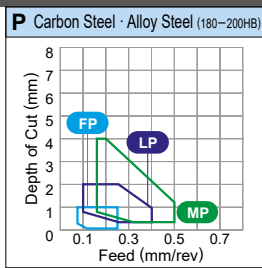
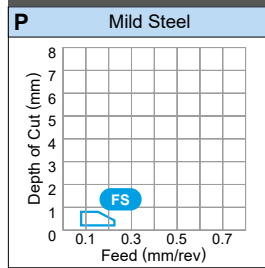

Cutting Conditions (Guide) : ●: Stable Cutting ●: General Cutting ☆: Unstable Cutting

Work Material	Shape	Order Number	RE (mm)	Coated																Cermet	Coated Cermet	Carbide	Applicable Holder Page																	
				UE6105	UE6110	UE6020	MC6115 <small>NEW</small>	MC6015	MC6025	MC6035	UH6400	MS6015	MC7015	MC7025	MP7035	US735	US905	MC5005	MC5015					MH515 <small>NEW</small>	MP9005	MP9015	MP9025 <small>NEW</small>	VP05RT	VP10RT	VP15TF	UP20M	NX2525	NX3035	MP3025	AP25N	VP25N	UT120T	HT110	RT9010	MT9015
P Mild Steel		VNMG160402-FP	0.2																							●														
		VNMG160404-FP	0.4					★																				●												
		VNMG160408-FP	0.8					●																				●												
		VNMG160412-FP	1.2					●																				●												
P Carbon Steel / Alloy Steel (180-200HB)		VNMG160402-FH	0.2					★																			●													
		VNMG160404-FH	0.4					★																				●												
		VNMG160408-FH	0.8					★																				●												
P Mild Steel		VNMG160404-FS	0.4																								●													
		VNMG160408-FS	0.8																									●												
P Carbon Steel / Alloy Steel (180-200HB)		VNGG1604V5-FJ	0.05																																	★				
		VNGG160401-FJ	0.1																																	●				
		VNGG160402-FJ	0.2																																	●				
M Stainless Steel (≤200HB)		VNGG160402R-F	0.2																								★	★	★											
		VNGG160402L-F	0.2																								★	★	★											
		VNGG160404R-F	0.4																								●	★	★	★										
		VNGG160404L-F	0.4																								★	★	★											
K Cast Iron (≤350MPa)		VNMG160404-LP	0.4				●	●	●	●	●	●	●	●														●												
		VNMG160408-LP	0.8				●	●	●	●	●	●	●	●															●											
M Stainless Steel (≤200HB)		VNMG160404-LM	0.4																																					
		VNMG160408-LM	0.8																																					

● = NEW

● : Inventory maintained. ★ : Inventory maintained in Japan.

TURNING INSERTS [NEGATIVE]



35° VN TYPE INSERTS WITH HOLE

VNMG 16 04 04- MS

Size Thickness Corner Radius Chipbreaker
* Please refer to page A002.

CHIP CONTROL RANGE FOR WORK MATERIALS

Finish Cutting..... Light Cutting..... Medium Cutting..... Rough Cutting..... Heavy Cutting.....

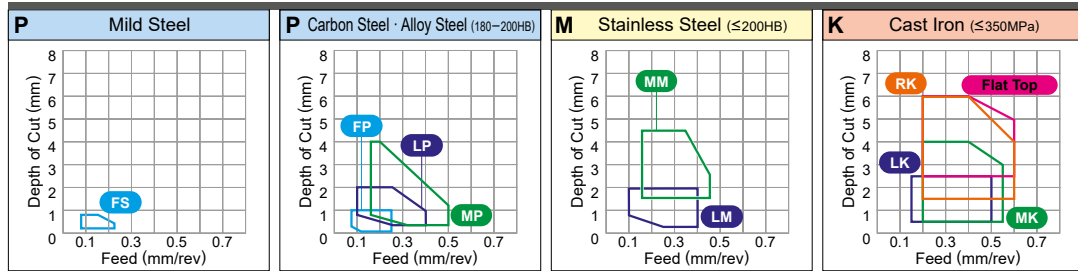

Cutting Conditions (Guide) : ● : Stable Cutting ● : General Cutting ✦ : Unstable Cutting

Work Material	P	M	K	N	S																																		
	Steel	Stainless Steel	Cast Iron	Non-ferrous Metal	Heat-resistant Alloy, Titanium Alloy																																		
Shape	Coated					Cermet	Coated Cermet	Carbide	Applicable Holder Page																														
Order Number	UE6105	UE6110	UE6020	MC6115 NEW	MC6015	MC6025	MC6035	UH6400		MS6015	MC7015	MC7025	MP7035	US735	US905	MC5005	MC5015	MH515 NEW	MP9005	MP9015	MP9025 NEW	VP05RT	VP10RT	VP15TF	UP20M	NX2525	NX3035	MP3025	AP25N	VP25N	UT120T	HT110	RT9010	MT9015					
* MS	VNMG160404-MS	0.4																●	●	●																	★	C019 -021 E017	
	VNMG160408-MS	0.8																●	●	●																●			
Medium Cutting																																							
MS	VNMG160404-MS	0.4	●								●	★										●	●	★														C019 -021 E017	
	VNMG160408-MS	0.8	★								●	★										●	●														●		
Medium Cutting																																							
GK	VNMG160404-GK	0.4													●	●																						C019 -021 E017	
	VNMG160408-GK	0.8													●	●																							
	VNMG160412-GK	1.2													●	●																							
Medium Cutting																																							
GM	VNMG160404-GM	0.4									●	●	★																									C019 -021 E017	
	VNMG160408-GM	0.8									★	●	●																										
Medium Cutting																																							
MA	VNMG160404-MA	0.4	●	●	●	●	●				●	★	●		●	●																						C019 -021 E017	
	VNMG160408-MA	0.8	●	●	●	●	●				●	★	●		●	●																							
Medium Cutting																																							
MH	VNMG160404-MH	0.4	★	●	★	★																																C019 -021 E017	
	VNMG160408-MH	0.8	●	★	●	●	●	●	★																														
Medium Cutting																																							
Standard	VNMG160404	0.4	●	●	●	●	●																															C019 -021 E017	
	VNMG160408	0.8	●	●	●	●	●																																
	VNMG160412	1.2	●	●	●	●	●																																
Medium Cutting																																							

*Newly designed breakers : MP9005, MP9015, MP9025, MT9015

● = NEW

● : Inventory maintained. ★ : Inventory maintained in Japan.

TURNING INSERTS [NEGATIVE]



WN TYPE INSERTS WITH HOLE

WNMG 08 04 02- FP

Size Thickness Corner Radius Chipbreaker
* Please refer to page A002.

CHIP CONTROL RANGE FOR WORK MATERIALS

Finish Cutting..... Light Cutting..... Medium Cutting..... Rough Cutting..... Heavy Cutting.....

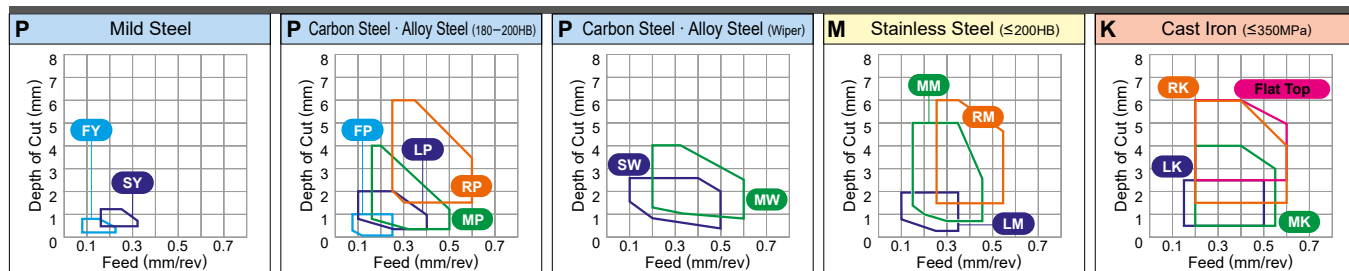

Cutting Conditions (Guide) : ● : Stable Cutting ● : General Cutting ✦ : Unstable Cutting

Work Material	Shape	Order Number	RE (mm)	Coated															Cermert	Coated Cermert	Carbide	Applicable Holder Page																	
				UE6105	UE6110	UE6020	NEW MC6115	MC6015	MC6025	MC6035	UH6400	MS6015	MC7015	MC7025	MP7035	US735	US905	MC5005					MC5015	NEW MH515	NEW MP9005	NEW MP9015	NEW MP9025	VP05RT	VP10RT	VP15TF	UP20M	NX2525	NX3035	MP3025	AP25N	VP25N	UT120T	HT110	RT9010
P Steel	FP	WNMG080402-FP	0.2	●●●●●●●●●●●●●●●●																																			
		WNMG080404-FP	0.4																																			C022	
		WNMG080408-FP	0.8																																				C023
		WNMG080412-FP	1.2																																				E017
P Carbon Steel - Alloy Steel (180-200HB)	FH	WNMG080404-FH	0.4		★																																C022		
		WNMG080408-FH	0.8		★																																	C023	
P Carbon Steel - Alloy Steel (Wiper)	FS	WNMG080404-FS	0.4																																		C022		
		WNMG080408-FS	0.8																																			C023	
M Stainless Steel (<=200HB)	FY	WNMG080404-FY	0.4																																		C022		
		WNMG080408-FY	0.8		★																																	C023	
K Cast Iron (<=350MPa)	LP	WNMG060404-LP	0.4		★	★		●●●																													C022		
		WNMG060408-LP	0.8		●	★		●●●																													C023		
		WNMG06T304-LP	0.4		★	★		●●●																														E017	
		WNMG06T308-LP	0.8		★	★		●●●																														E039	
		WNMG080404-LP	0.4		●	●		●●●	●●●																														
		WNMG080408-LP	0.8		★	●		●●●	●●●																														
Light Cutting	LM	WNMG060404-LM	0.4																																		C022		
		WNMG060408-LM	0.8																																		C023		
		WNMG080404-LM	0.4																																			E017	
		WNMG080408-LM	0.8																																				

● = NEW

● : Inventory maintained. ★ : Inventory maintained in Japan.

Cutting Conditions (Guide) : ● : Stable Cutting ● : General Cutting ✦ : Unstable Cutting

Work Material	P	Steel																																			
	M	Stainless Steel																																			
	K	Cast Iron																																			
	N	Non-ferrous Metal																																			
	S	Heat-resistant Alloy, Titanium Alloy																																			
Shape	Order Number	RE (mm)	Coated															Cermet	Coated Cermet	Carbide			Applicable Holder Page														
			UE6105	UE6110	MC6020	MC6115 NEW	MC6015	MC6025	MC6035	UH6400	MS6015	MC7015	MC7025	MP7035	US735	US905	MC5005	MC5015	MH515 NEW	MP9005	MP9015	MP9025 NEW		VP05RT	VP10RT	VP15TF	UP20M	NX2525	NX3035	MP3025	AP25N	VP25N	UT120T	HT110	RT9010	MT9015	
 Medium Cutting	WNUMG060404-GK	0.4	●	●	●	●	●	●	●	●	●	●	●	●	●	●	●	●	●	●	●	●	●	●	●	●	●	●	●	●	●						
	WNUMG060408-GK	0.8													●	●																					
	WNUMG080404-GK	0.4																																			
	WNUMG080408-GK	0.8																●	●																		
	WNUMG080412-GK	1.2																●	●	●																	
 Medium Cutting	WNUMG060404-GM	0.4								●	●	●																									
	WNUMG060408-GM	0.8								●	●	●																									
	WNUMG080404-GM	0.4								●	●	●																									
	WNUMG080408-GM	0.8								●	●	●																									
	WNUMG080412-GM	1.2								●	●	●																									
 Medium Cutting	WNUMG06T304-MA	0.4	●	●													●																				
	WNUMG06T308-MA	0.8	●	●														●																			
	WNUMG06T312-MA	1.2	●	●														●																			
	WNUMG060404-MA	0.4	●	●			●	●																													
	WNUMG060408-MA	0.8	●	●			●	●			●	●	●																								
	WNUMG060412-MA	1.2	●	●			●	●			●	●	●																								
	WNUMG080404-MA	0.4	●	●	●	●	●	●			●	●	●															●									
	WNUMG080408-MA	0.8	●	●	●	●	●	●			●	●	●															●		●							
	WNUMG080412-MA	1.2	●	●	●	●	●	●			●	●	●															●		●							
	WNUMG080416-MA	1.6	●	●	●	●	●	●																													
 Medium Cutting	WNUMG080404-MH	0.4	●	●	●	●	●																														
	WNUMG080408-MH	0.8	●	●	●	●	●	●	●																												
	WNUMG080412-MH	1.2	●	●	●	●	●	●	●																												
 Medium Cutting	WNUMG080404	0.4	●	●	●	●	●																			●		●									
	WNUMG080408	0.8	●	●	●	●	●	●																		●		●		●							
	WNUMG080412	1.2	●	●	●	●	●	●																													
 Medium Cutting (Wiper)	WNUMG060408-MW	0.8	●	●			●	●									●	●																			
	WNUMG060412-MW	1.2	●	●			●	●									●	●																			
	WNUMG080408-MW	0.8	●	●	●	●	●	●										●	●																		
	WNUMG080412-MW	1.2	●	●	●	●	●	●										●	●																		
 Rough Cutting	WNUMG080408-RP	0.8	●	●	●	●	●																														
	WNUMG080412-RP	1.2	●	●	●	●	●																														
 Rough Cutting	WNUMG060408-RM	0.8								●	●	●																									
	WNUMG060412-RM	1.2								●	●	●																									
	WNUMG080408-RM	0.8								●	●	●																									
	WNUMG080412-RM	1.2								●	●	●																									

* Please refer to page A028 before using the MW breaker (wiper insert).

● = NEW

A

TURNING INSERTS

NEG

WITH HOLE

C

D

R

S

T

V

W

TURNING INSERTS [NEGATIVE]



WN TYPE INSERTS WITH HOLE

WNMG 08 04 08- RK

Size Thickness Corner Radius Chipbreaker
* Please refer to page A002.

CHIP CONTROL RANGE FOR WORK MATERIALS

Finish Cutting..... Light Cutting..... Medium Cutting..... Rough Cutting..... Heavy Cutting.....

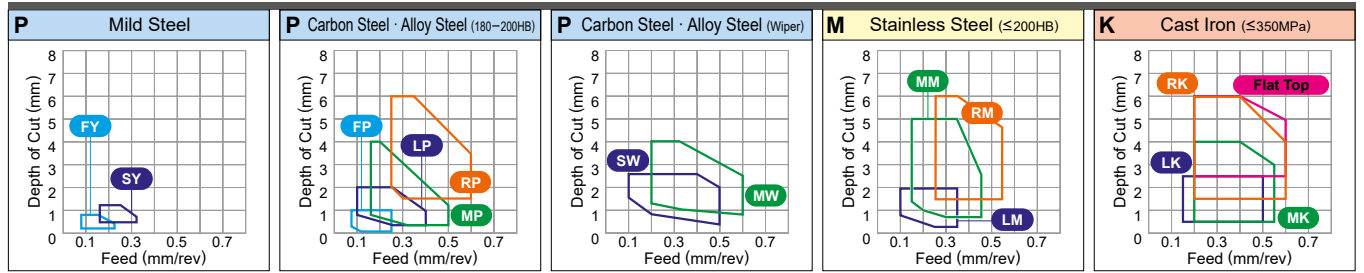

Cutting Conditions (Guide) : ● : Stable Cutting ● : General Cutting ✦ : Unstable Cutting

Work Material	Coated		Cermet		Coated Cermet		Carbide		Applicable Holder Page																										
	UE6105	UE6110	UE6020	MC6115	MC6015	MC6025	UH6400	MS6015		MC7015	MC7025	MP7035	US735	US905	MC5005	MC5015	MH515	MP9005	MP9015	MP9025	VP05RT	VP10RT	VP15TF	UP20M	NX2525	NX3035	MP3025	AP25N	VP25N	UT120T	HT110	RT19010	MT9015		
P Steel	●●●●●●●●	●●●●●●●●	●●●●●●●●	●●●●●●●●	●●●●●●●●	●●●●●●●●	●●●●●●●●	●●●●●●●●																											
M Stainless Steel				●●●●●●	●●●●●●	●●●●●●	●●●●●●	●●●●●●																											
K Cast Iron																																			
N Non-ferrous Metal																																			
S Heat-resistant Alloy, Titanium Alloy																																			
Shape	Order Number	RE (mm)																																	
RK 	WNMG080408-RK	0.8																																	
	WNMG080412-RK	1.2																																	
	WNMG080416-RK	1.6																																	
RS 	WNMG080408-RS	0.8																																	
	WNMG080412-RS	1.2																																	
	WNMG080416-RS	1.6																																	
	WNMG100612-RS	1.2																																	
GH 	WNMG080408-GH	0.8	●●	★●						●																									
	WNMG080412-GH	1.2	●●	★●						●																									
GJ 	WNMG080408-GJ	0.8								●												●										★			
	WNMG080412-GJ	1.2								★												●										★			
	WNMG080416-GJ	1.6								★												●										★			
	WNMG100612-GJ	1.2																					●									★			
Flat Top 	WNMA060408	0.8													★●																				
	WNMA060412	1.2													★●																				
	WNMA080404	0.4													●●																	●			
	WNMA080408	0.8													●●																	●			
	WNMA080412	1.2													●●																	□			
	WNMA080416	1.6													●●																				

● = NEW

● : Inventory maintained. ★ : Inventory maintained in Japan.

□ : Non stock, produced to order only.

CHIP CONTROL RANGE FOR WORK MATERIALS

Heavy Cutting.....

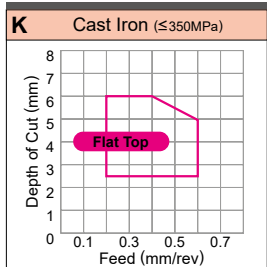

Cutting Conditions (Guide) : ●: Stable Cutting ●: General Cutting ✦: Unstable Cutting

Work Material	P	Steel	●	●	●	●	●	●	●	●	●	●	●	●	●	●	●	●	●																		
	M	Stainless Steel	●	●	●	●	●	●	●	●	●	●	●	●	●	●	●	●	●																		
K	Cast Iron	●	●	●	●	●	●	●	●	●	●	●	●	●	●	●	●	●	●																		
N	Non-ferrous Metal	●	●	●	●	●	●	●	●	●	●	●	●	●	●	●	●	●	●																		
S	Heat-resistant Alloy, Titanium Alloy	●	●	●	●	●	●	●	●	●	●	●	●	●	●	●	●	●	●																		
Shape	Order Number	RE (mm)	Coated															Cermets	Coated Cermets	Carbide	Applicable Holder Page																
			UE6105	UE6110	UE620	MC6115 NEW	MC6015	MC6025	MC6035	UH6400	MS6015	MC7015	MC7025	MP7035	US735	US905	MC5005	MC5015	MH515 NEW	MP9005		MP9015	MP9025 NEW	VP05RT	VP10RT	VP15TF	UP20M	NX2525	NX3035	MP3025	AP25N	VP25N	UTi20T	HTi10	RT9010	MT9015	
Flat Top	SNMN090308	0.8																																			
	SNMN120408	0.8														★	●																				
	SNMN120412	1.2														★	●																				
	SNMN120416	1.6														★	★																				
	SNMN190412	1.2																																			
Flat Top	SNGN090308	0.8																																			
	SNGN120404	0.4																																			
	SNGN120408	0.8																																			

● = NEW

TURNING INSERTS

A

NEG

WITHOUT HOLE

C

D

R

S

T

V

W

CHIPBREAKERS > A070
 GRADES > A030
 IDENTIFICATION > A002

TURNING INSERTS [NEGATIVE]



TNMN 16 03 08

Size Thickness Corner Radius
* Please refer to page A002.

CHIP CONTROL RANGE FOR WORK MATERIALS

Heavy Cutting.....

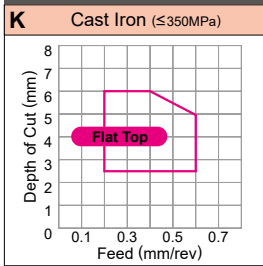

A

TURNING INSERTS

NEG

WITHOUT HOLE

C

D

R

S

T

V

W

Cutting Conditions (Guide) : ● : Stable Cutting ● : General Cutting ✖ : Unstable Cutting

Work Material	P	Steel																																					
	M	Stainless Steel																																					
Shape	K	Cast Iron																Applicable Holder Page																					
	N	Non-ferrous Metal																																					
	S	Heat-resistant Alloy, Titanium Alloy																																					
	Order Number	RE (mm)	Coated										Cermet	Coated Cermet	Carbide																								
			UE6105	UE6110	UE620	MC6115 <small>NEW</small>	MC6015	MC6025	MC6035	UH6400	MS6015	MC7015	MC7025	MP7035	US735		US905	MC5005	MC5015	MH515 <small>NEW</small>	MP9005	MP9015	MP9025 <small>NEW</small>	VP05RT	VP10RT	VP15TF	UP20M	NX2525	NX3035	MP3025	AP25N	VP25N	UTi20T	HTi10	RT9010	MT9015			
Flat Top	TNMN160308	0.8																																					
	TNMN160408	0.8															★ ●											★											
	TNMN160412	1.2															★ ●																						
	TNMN160416	1.6															★ ★																						
	TNMN220408	0.8																										●											
	TNMN220412	1.2																																					
Flat Top	TNGN110304	0.4																																					
	TNGN110308	0.8																																					
	TNGN160404	0.4																																					
	TNGN160408	0.8																																					

● = NEW

● : Inventory maintained. ★ : Inventory maintained in Japan.

TURNING INSERTS [POSITIVE]



CCMT 06 02 02- FP

Size Thickness Corner Radius Chipbreaker
* Please refer to page A002.

CHIP CONTROL RANGE FOR WORK MATERIALS

Finish Cutting.....

Light Cutting.....

Medium Cutting.....

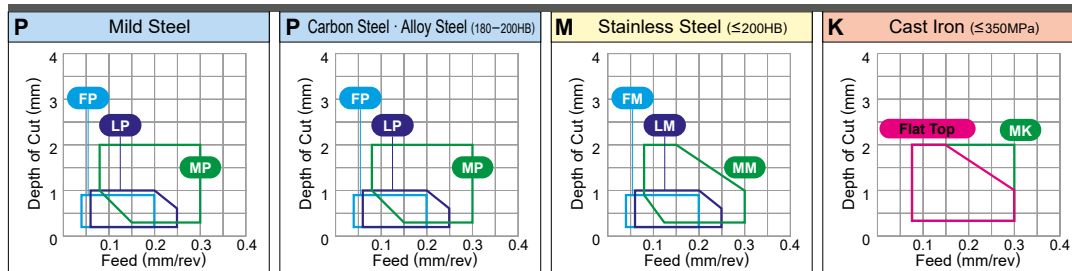

Cutting Conditions (Guide) : ● : Stable Cutting ● : General Cutting ✦ : Unstable Cutting

Work Material	Shape	Order Number	RE (mm)	Coated													Cermet	Coated Cermet		Carbide			Applicable Holder Page														
				UE6105	UE6110	MC6015	MC6025	UH6400	MS6015	MC7025	MP7035	US735	US905	MC5005	MC5015	MH515		MP9005	MP9015	MP9025	MS9025	VP05RT		VP10RT	VP15TF	UP20M	NX2525	NX3035	MP3025	AP25N	VP25N	VP45N	UT120T	HT110	RT9010	MT9005	MT9015
P Steel	FP	CCMT060202-FP	0.2	●●●																															C024		
		CCMT060204-FP	0.4	●●●																															D010		
		CCMT09T302-FP	0.2	★●●																															E007		
		CCMT09T304-FP	0.4	●●●																															E008		
		CCMT09T308-FP	0.8	★●●																																E032	
M Stainless Steel	FM	CCMT060202-FM	0.2																																C024		
		CCMT060204-FM	0.4																																D010		
		CCMT09T302-FM	0.2																																	E007	
		CCMT09T304-FM	0.4																																	E008	
		CCMT09T308-FM	0.8																																	E032	
N Non-ferrous Metal	FS	CCGT060201M-FS	0.08																																C024		
		CCGT060202M-FS	0.18																																D010		
		CCGT09T301M-FS	0.08																																	E007	
		CCGT09T302M-FS	0.18																																	E008	
		CCGT09T304M-FS	0.38																																	E032	
S Heat-resistant Alloy, Titanium Alloy	FS-P	CCGT060201M-FS-P	0.08																																C024		
		CCGT060202M-FS-P	0.18																																	D010	
		CCGT09T301M-FS-P	0.08																																	E007	
		CCGT09T302M-FS-P	0.18																																		E008
		CCGT09T304M-FS-P	0.38																																		E032
K Cast Iron	FV	CCMT060202-FV	0.2																																	C024	
		CCMT060204-FV	0.4																																	D010	
		CCMT09T302-FV	0.2																																		E007
		CCMT09T304-FV	0.4																																		E008
		CCMT09T308-FV	0.8																																		E032
P Mild Steel	FJ	CCGT0602V5-FJ	0.05																																	C024	
		CCGT060201-FJ	0.1																																	D010	
		CCGT060202-FJ	0.2																																		E007
		CCGT09T3V5-FJ	0.05																																		E008
		CCGT09T301-FJ	0.1																																		E032
M Stainless Steel	MM	CCGT09T302-FJ	0.2																																	E036	
		CCGT09T304-FJ	0.4																																		

● = NEW

CHIPBREAKERS > A058
GRADES > A030
IDENTIFICATION > A002

A

TURNING INSERTS

7° POSI

WITH HOLE

C

D

R









S

T

V

W

Cutting Conditions (Guide) : ● : Stable Cutting ● : General Cutting ✨ : Unstable Cutting

Work Material	P	Steel	●																																												Applicable Holder Page
	M	Stainless Steel	●																						●																						
Shape	K	Cast Iron	●																						●																						Applicable Holder Page
	N	Non-ferrous Metal	●																						●																						
Work Material	S	Heat-resistant Alloy, Titanium Alloy	●																						●																						Applicable Holder Page
	Order Number			RE (mm)			Coated														Cermets		Coated Cermet		Carbide																						
						UE6105	UE6110	MC6015	MC6025	UH6400	MS6015	MC7025	MP7035	US735	US905	MC5005	MC5015	MH515	MP9005	MP9015	MP9025	MS9025	VP05RT	VP10RT	VP15TF	VP20M	NX2525	NX3035	MP3025	AP25N	VP25N	VP45N	UT120T	HT110	RT9010	MT9005	MT9015										
 R/L-F Finish Cutting	NEW CCGH060202MR-F	0.18																						C024																							
	NEW CCGH060202ML-F	0.18																						D010																							
	NEW CCGH060204MR-F	0.38																						E007																							
	NEW CCGH060204ML-F	0.38																						E008																							
 LP Light Cutting	CCMT060204-LP	0.4	●●●																●					C024																							
	CCMT060208-LP	0.8	★●●																●		★			D010																							
	CCMT09T304-LP	0.4	●●●																●		●			E007																							
	CCMT09T308-LP	0.8	●●●																●		★			E008																							
 LM Light Cutting	CCMT060204-LM	0.4	●●														●		●					C024																							
	CCMT060208-LM	0.8	●★																●					D010																							
	CCMT09T304-LM	0.4	●●														●		●					E007																							
	CCMT09T308-LM	0.8	●●														●		●					E008																							
 LS Light Cutting	CCMT060202-LS	0.2																			●			C024																							
	CCMT060204-LS	0.4																			●			D010																							
	CCMT09T302-LS	0.2																			●			E007																							
	CCMT09T304-LS	0.4																			●			E008																							
	CCMT09T308-LS	0.8																			●			E032																							
 LS Light Cutting	CCGT060201M-LS	0.08																			●			C024																							
	CCGT060202M-LS	0.18																			●			D010																							
	CCGT09T301M-LS	0.08																			●			E007																							
	CCGT09T302M-LS	0.18																			●			E008																							
	CCGT09T304M-LS	0.38																			●			E032																							
 LS-P Light Cutting	CCGT060201M-LS-P	0.08	●																		●			C024																							
	CCGT060202M-LS-P	0.18	●																		●			D010																							
	CCGT09T301M-LS-P	0.08	●																		●			E007																							
	CCGT09T302M-LS-P	0.18	●																		●			E008																							
	CCGT09T304M-LS-P	0.38	●																		●			E032																							
 SV Light Cutting	CCMH060202-SV	0.2	●														●		●		●			C024																							
	CCMH060204-SV	0.4	●														●		●		●			D010																							
 * SW Light Cutting (Wiper)	CCMT060202-SW	0.2	●●●																●		★			C024																							
	CCMT060204-SW	0.4	●●●																●		★			D010																							
	CCMT09T302-SW	0.2	●●●																●		★			E007																							
	CCMT09T304-SW	0.4	●●●																●		★			E008																							

* Please refer to page A028 before using the SW breaker (wiper insert).

● = NEW

A

TURNING INSERTS

POSI
7°

WITH HOLE

C

D

R

S

T

V

W

CHIPBREAKERS > A058
 GRADES > A030
 IDENTIFICATION > A002

TURNING INSERTS [POSITIVE]

80° CC TYPE INSERTS WITH HOLE

CCGT 06 02 V3 R-SS

Size Thickness Corner Radius R/L Chipbreaker
* Please refer to page A002.

CHIP CONTROL RANGE FOR WORK MATERIALS

Finish Cutting.....

Light Cutting.....

Medium Cutting.....

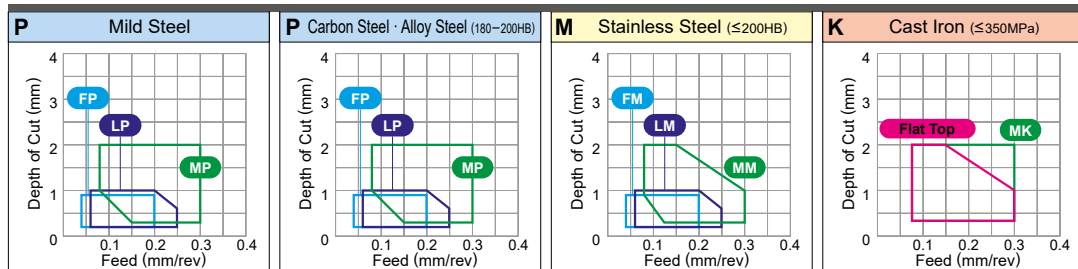

Cutting Conditions (Guide) : ● : Stable Cutting ● : General Cutting ✦ : Unstable Cutting

Work Material	Coated		Cermet	Coated Cermet	Carbide	Applicable Holder Page		
	P Steel	M Stainless Steel						
Work Material	M Stainless Steel							
	K Cast Iron							
Work Material	N Non-ferrous Metal							
	S Heat-resistant Alloy, Titanium Alloy							
Shape	Order Number	RE (mm)	Coated		Cermet	Coated Cermet	Carbide	Applicable Holder Page
			UE6105 UE6110 MC6015 MC6025 UH6400 MS6015 MC7025 MP7035 US735 US905 MC5005 MC5015 MH515 MP9005 MP9015 MP9025 MS9025 VP05RT VP10RT VP15TF UP20M NX2525 NX3035 MP3025 AP25N VP25N VP45N UT120T HT110 RT9010 MT9005 MT9015					
R/L-SS	CCGT0602V3R-SS	0.03						
	CCGT0602V3L-SS	0.03						
	CCGT060201R-SS	0.1						
	CCGT060201L-SS	0.1						
	CCGT060202R-SS	0.2						C024
	CCGT060202L-SS	0.2						D010
	CCGT09T3V3R-SS	0.03						E007
	CCGT09T3V3L-SS	0.03						E008
	CCGT09T301R-SS	0.1						E032
	CCGT09T301L-SS	0.1						E036
	CCGT09T302R-SS	0.2						
	CCGT09T302L-SS	0.2						
	CCGT060201MR-SS	0.08						
	NEW CCGT060201ML-SS	0.08						
	CCGT060202MR-SS	0.18						
	NEW CCGT060202ML-SS	0.18						
	CCGT09T301MR-SS	0.08						
	NEW CCGT09T301ML-SS	0.08						
CCGT09T302MR-SS	0.18							
NEW CCGT09T302ML-SS	0.18							
CCGT09T304MR-SS	0.38							
Light Cutting	NEW CCGT09T304ML-SS	0.38						
MP	CCMT060204-MP	0.4						
	CCMT060208-MP	0.8						
	CCMT09T304-MP	0.4						
	CCMT09T308-MP	0.8						
	CCMT120404-MP	0.4						
	CCMT120408-MP	0.8						
Medium Cutting	CCMT120412-MP	1.2						
MM	CCMT060204-MM	0.4						
	CCMT060208-MM	0.8						
	CCMT09T304-MM	0.4						
	CCMT09T308-MM	0.8						
	CCMT120404-MM	0.4						
	CCMT120408-MM	0.8						
	Medium Cutting	CCMT120412-MM	1.2					

● = NEW

● : Inventory maintained. ★ : Inventory maintained in Japan.

TURNING INSERTS [POSITIVE]



CCET 06 02 04 R-SR

Size Thickness Corner Radius R/L Chipbreaker
 * Please refer to page A002.

CHIP CONTROL RANGE FOR WORK MATERIALS

Finish Cutting.....

Light Cutting.....

Medium Cutting.....

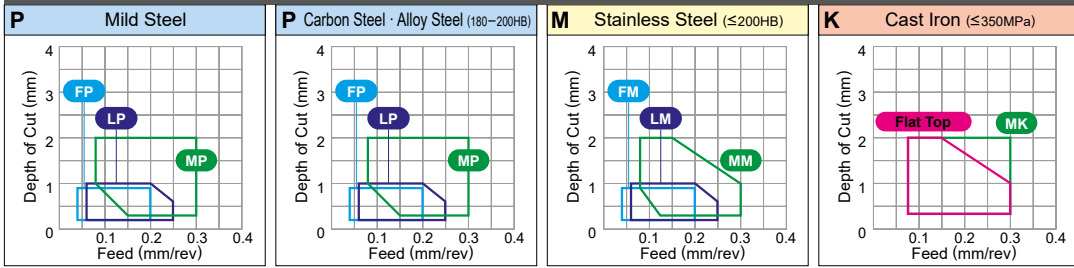

TURNING INSERTS

A

Cutting Conditions (Guide) : ● : Stable Cutting ● : General Cutting ✦ : Unstable Cutting

Work Material	P Steel		M Stainless Steel		K Cast Iron		N Non-ferrous Metal		S Heat-resistant Alloy, Titanium Alloy		Coated												Cermet	Coated Cermet	Carbide	Applicable Holder Page																
	P	M	M	K	K	N	S	UE6105	UE6110	MC6015	UH6400	MS6015	MC7025	MP7035	US735	US905	MC5005	MC5015	NEW MH515	MP9005	MP9015	NEW MP9025	MS9025	VP05RT	VP10RT		VP15TF	UP20M	NX2525	NX3035	MP3025	AP25N	VP25N	VP45N	UTI20T	HT110	RT9010	MT9005	MT9015			
	●	●	●	●	●	●	●	●	●	●	●	●	●	●	●	●	●	●	●	●	●	●	●	●	●		●	●	●	●	●	●	●	●	●	●	●	●	●			
R/L-SR	CCET060204R-SR	0.4																																								
	CCET060204L-SR	0.4																																								
	CCET09T3V3R-SR	0.03																																								
	CCET09T3V3L-SR	0.03																																								
	CCET09T301R-SR	0.1																																								
	CCET09T301L-SR	0.1																																								
	CCET09T302R-SR	0.2																																								
	CCET09T302L-SR	0.2																																								
	CCET09T304R-SR	0.4																																								
	CCET09T304L-SR	0.4																																								
R/L-SN	CCGT0602V3R-SN	0.03																																								
	CCGT060201R-SN	0.1																																								
	CCGT060201L-SN	0.1																																								
	CCGT060202R-SN	0.2																																								
	CCGT060202L-SN	0.2																																								
	CCGT09T3V3R-SN	0.03																																								
	CCGT09T3V3L-SN	0.03																																								
	CCGT09T301R-SN	0.1																																								
	CCGT09T301L-SN	0.1																																								
	CCGT09T302R-SN	0.2																																								
CCGT09T302L-SN	0.2																																									
CCGT09T304R-SN	0.4																																									
CCGT09T304L-SN	0.4																																									
CCGT060201MR-SN	0.08																																									
NEW CCGT060201ML-SN	0.08																																									
CCGT060202MR-SN	0.18																																									
NEW CCGT060202ML-SN	0.18																																									
CCGT09T301MR-SN	0.08																																									
NEW CCGT09T301ML-SN	0.08																																									
CCGT09T302MR-SN	0.18																																									
NEW CCGT09T302ML-SN	0.18																																									
CCGT09T304MR-SN	0.38																																									
NEW CCGT09T304ML-SN	0.38																																									

● = NEW

● : Inventory maintained. ★ : Inventory maintained in Japan.

□ : Non stock, produced to order only.

TURNING INSERTS [POSITIVE]

80° CP TYPE INSERTS WITH HOLE

CPMH 08 02 02- FV

Size Thickness Corner Radius Chipbreaker
* Please refer to page A002.

CHIP CONTROL RANGE FOR WORK MATERIALS

Finish Cutting.....

Light Cutting.....

Medium Cutting.....

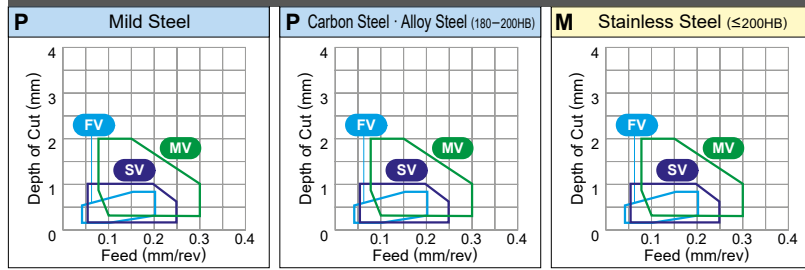

TURNING INSERTS

A

Cutting Conditions (Guide) : ● : Stable Cutting ● : General Cutting ⊕ : Unstable Cutting

Work Material	P Steel	M Stainless Steel	K Cast Iron	N Non-ferrous Metal	S Heat-resistant Alloy, Titanium Alloy	Coated														Cermet	Coated Cermet	Carbide	Applicable Holder Page														
						UE6105	UE6110	MC6015	MC6025	UH6400	MS6015	MC7025	MP7035	US735	US905	MC5005	MC5015	MH515	MP9005					MP9015	MP9025	MS9025	VP05RT	VP10RT	VP15TF	UP20M	NX2525	NX3035	MP3025	AP25N	VP25N	VP45N	UT120T
 Finish Cutting	CPMH080202-FV	0.2	●	●	●	●	●	●	●	●	●	●	●	●	●	●	●	●	●	●	●	●	●	●	●	●	●	●	●	●	●	●	●	●	●	E007	
	CPMH080204-FV	0.4	●	●	●	●	●	●	●	●	●	●	●	●	●	●	●	●	●	●	●	●	●	●	●	●	●	●	●	●	●	●	●	●	●	E008	
	CPMH090302-FV	0.2	●	●	●	●	●	●	●	●	●	●	●	●	●	●	●	●	●	●	●	●	●	●	●	●	●	●	●	●	●	●	●	●	●	●	●
	CPMH090304-FV	0.4	●	●	●	●	●	●	●	●	●	●	●	●	●	●	●	●	●	●	●	●	●	●	●	●	●	●	●	●	●	●	●	●	●	●	●
	CPMH090308-FV	0.8	●	●	●	●	●	●	●	●	●	●	●	●	●	●	●	●	●	●	●	●	●	●	●	●	●	●	●	●	●	●	●	●	●	●	●
 Finish Cutting	CPGT080202	0.2	●	●	●	●	●	●	●	●	●	●	●	●	●	●	●	●	●	●	●	●	●	●	●	●	●	●	●	●	●	●	●	●	●	●	
	CPGT080204	0.4	●	●	●	●	●	●	●	●	●	●	●	●	●	●	●	●	●	●	●	●	●	●	●	●	●	●	●	●	●	●	●	●	●	●	
	CPGT090302	0.2	●	●	●	●	●	●	●	●	●	●	●	●	●	●	●	●	●	●	●	●	●	●	●	●	●	●	●	●	●	●	●	●	●	●	
	CPGT090304	0.4	●	●	●	●	●	●	●	●	●	●	●	●	●	●	●	●	●	●	●	●	●	●	●	●	●	●	●	●	●	●	●	●	●	●	
 Finish Cutting	CPMH080204R-F	0.4	●	●	●	●	●	●	●	●	●	●	●	●	●	●	●	●	●	●	●	●	●	●	●	●	●	●	●	●	●	●	●	●	●	●	
	CPMH080204L-F	0.4	●	●	●	●	●	●	●	●	●	●	●	●	●	●	●	●	●	●	●	●	●	●	●	●	●	●	●	●	●	●	●	●	●	●	
	CPMH090304R-F	0.4	●	●	●	●	●	●	●	●	●	●	●	●	●	●	●	●	●	●	●	●	●	●	●	●	●	●	●	●	●	●	●	●	●	●	
	CPMH090304L-F	0.4	●	●	●	●	●	●	●	●	●	●	●	●	●	●	●	●	●	●	●	●	●	●	●	●	●	●	●	●	●	●	●	●	●	●	
 Finish Cutting	CPGT080204R-F	0.4	●	●	●	●	●	●	●	●	●	●	●	●	●	●	●	●	●	●	●	●	●	●	●	●	●	●	●	●	●	●	●	●	●	●	
	CPGT080204L-F	0.4	●	●	●	●	●	●	●	●	●	●	●	●	●	●	●	●	●	●	●	●	●	●	●	●	●	●	●	●	●	●	●	●	●	●	
	CPGT090302R-F	0.2	●	●	●	●	●	●	●	●	●	●	●	●	●	●	●	●	●	●	●	●	●	●	●	●	●	●	●	●	●	●	●	●	●	●	
	CPGT090302L-F	0.2	●	●	●	●	●	●	●	●	●	●	●	●	●	●	●	●	●	●	●	●	●	●	●	●	●	●	●	●	●	●	●	●	●	●	
	CPGT090304R-F	0.4	●	●	●	●	●	●	●	●	●	●	●	●	●	●	●	●	●	●	●	●	●	●	●	●	●	●	●	●	●	●	●	●	●	●	
 Light Cutting	CPMH080202-SV	0.2	●	●	●	●	●	●	●	●	●	●	●	●	●	●	●	●	●	●	●	●	●	●	●	●	●	●	●	●	●	●	●	●	●	●	
	CPMH080204-SV	0.4	●	●	●	●	●	●	●	●	●	●	●	●	●	●	●	●	●	●	●	●	●	●	●	●	●	●	●	●	●	●	●	●	●	●	
	CPMH090302-SV	0.2	●	●	●	●	●	●	●	●	●	●	●	●	●	●	●	●	●	●	●	●	●	●	●	●	●	●	●	●	●	●	●	●	●	●	
	CPMH090304-SV	0.4	●	●	●	●	●	●	●	●	●	●	●	●	●	●	●	●	●	●	●	●	●	●	●	●	●	●	●	●	●	●	●	●	●	●	
 Medium Cutting	CPMH080202-SV	0.8	●	●	●	●	●	●	●	●	●	●	●	●	●	●	●	●	●	●	●	●	●	●	●	●	●	●	●	●	●	●	●	●	●	●	
	CPMH090308-SV	0.8	●	●	●	●	●	●	●	●	●	●	●	●	●	●	●	●	●	●	●	●	●	●	●	●	●	●	●	●	●	●	●	●	●	●	
	CPMX080204	0.4	●	●	●	●	●	●	●	●	●	●	●	●	●	●	●	●	●	●	●	●	●	●	●	●	●	●	●	●	●	●	●	●	●	●	
	CPMX080208	0.8	●	●	●	●	●	●	●	●	●	●	●	●	●	●	●	●	●	●	●	●	●	●	●	●	●	●	●	●	●	●	●	●	●	●	
 Medium Cutting	CPMX090304	0.4	●	●	●	●	●	●	●	●	●	●	●	●	●	●	●	●	●	●	●	●	●	●	●	●	●	●	●	●	●	●	●	●	●	●	
	CPMX090308	0.8	●	●	●	●	●	●	●	●	●	●	●	●	●	●	●	●	●	●	●	●	●	●	●	●	●	●	●	●	●	●	●	●	●	●	
	CPMH080204-MV	0.4	●	●	●	●	●	●	●	●	●	●	●	●	●	●	●	●	●	●	●	●	●	●	●	●	●	●	●	●	●	●	●	●	●	●	
	CPMH080208-MV	0.8	●	●	●	●	●	●	●	●	●	●	●	●	●	●	●	●	●	●	●	●	●	●	●	●	●	●	●	●	●	●	●	●	●	●	
 Medium Cutting	CPMH090304-MV	0.4	●	●	●	●	●	●	●	●	●	●	●	●	●	●	●	●	●	●	●	●	●	●	●	●	●	●	●	●	●	●	●	●	●	●	
	CPMH090308-MV	0.8	●	●	●	●	●	●	●	●	●	●	●	●	●	●	●	●	●	●	●	●	●	●	●	●	●	●	●	●	●	●	●	●	●	●	

● = NEW

● : Inventory maintained. ★ : Inventory maintained in Japan.

CHIP CONTROL RANGE FOR WORK MATERIALS

Finish Cutting.....

Light Cutting.....

Medium Cutting.....

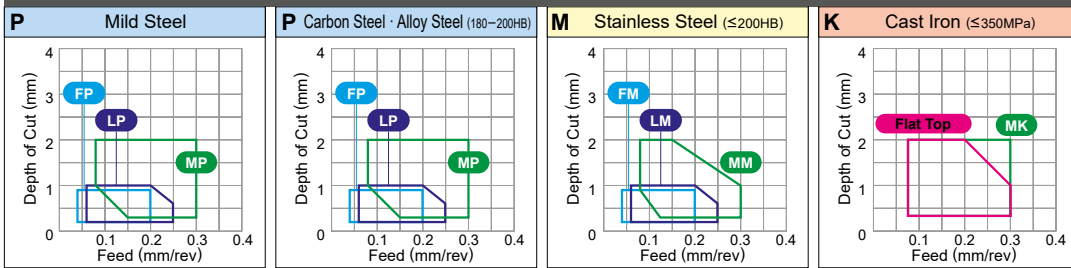

Cutting Conditions (Guide) : ● : Stable Cutting ● : General Cutting ✦ : Unstable Cutting

Work Material	P Steel		M Stainless Steel		K Cast Iron		N Non-ferrous Metal		S Heat-resistant Alloy, Titanium Alloy																											
	●	●	●	●	●	●	●	●	●	●																										
Shape	Order Number	RE (mm)	Coated										Cermet	Coated Cermet		Carbide		Applicable Holder Page																		
			UE6105	UE6110	MC6015	MC6025	UH6400	MS6015	MC7025	MP7035	US735	US905		MC5005	MC5015	MH515	MP9005		MP9015	MP9025	MS9025	VP05RT	VP10RT	VP15TF	UP20M	NX2525	NX3035	MP3025	AP25N	VP25N	VP45N	UTi20T	HTi10	RT9010	MT9005	MT9015
FP 	DCMT070202-FP	0.2	●	●	●																														C025	
	DCMT070204-FP	0.4	●	●	●																														D011	
	DCMT11T302-FP	0.2	●	●	●																														D026	
	DCMT11T304-FP	0.4	●	●	●																															E010
	DCMT11T308-FP	0.8	●	●	●																															E011
FM 	DCMT070202-FM	0.2																																	C025	
	DCMT070204-FM	0.4																																		D011
	DCMT11T302-FM	0.2																																		D026
	DCMT11T304-FM	0.4																																		E010
	DCMT11T308-FM	0.8																																		E011
FS 	DCGT070201M-FS	0.08													●	●																			C025	
	DCGT070202M-FS	0.18													●	●																			D011	
	DCGT11T301M-FS	0.08													●	●																			D026	
	DCGT11T302M-FS	0.18													●	●																			E010	
	DCGT11T302M-FS	0.18													●	●																			E011	
FS-P 	DCGT070201M-FS-P	0.08													●																				C025	
	DCGT070202M-FS-P	0.18													●																				D011	
	NEW DCGT070204M-FS-P	0.38													●																				D026	
	DCGT11T301M-FS-P	0.08													●																					E010
	DCGT11T302M-FS-P	0.18													●																					E011
	NEW DCGT11T304M-FS-P	0.38													●																					E031
FV 	DCMT070202-FV	0.2	●																																C025	
	DCMT070204-FV	0.4	●																																	D011
	DCMT070208-FV	0.8																																		D026
	DCMT11T302-FV	0.2																																		E010
	DCMT11T304-FV	0.4	●																																	E011
	DCMT11T308-FV	0.8	●																																	E031
AZ 	DCGT070202-AZ	0.2																																		C025
	DCGT070204-AZ	0.4																																		D011
	DCGT11T302-AZ	0.2																																		D026
	DCGT11T304-AZ	0.4																																		E010
	DCGT11T308-AZ	0.8																																		

● = NEW

TURNING INSERTS

7° POSI WITH HOLE

C

D

R

S

T

V

W

TURNING INSERTS [POSITIVE]



DCGT 07 02 02 R-F
 Size Thickness Corner Radius R/L Chipbreaker
 * Please refer to page A002.

CHIP CONTROL RANGE FOR WORK MATERIALS

Finish Cutting.....

Light Cutting.....

Medium Cutting.....

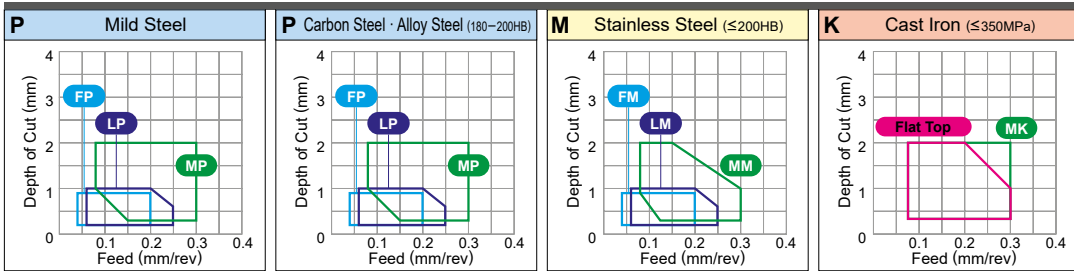

Cutting Conditions (Guide) : ● : Stable Cutting ● : General Cutting ✦ : Unstable Cutting

Work Material	P Steel	M Stainless Steel	K Cast Iron	N Non-ferrous Metal	S Heat-resistant Alloy, Titanium Alloy	Coated																Cermet	Coated Cermet	Carbide		Applicable Holder Page														
						UE6105	UE6110	MC6015	MC6025	UH6400	MS6015	MC7025	MP7035	US735	US905	MC5005	MC5015	MH515 NEW	MP9005	MP9015	MP9025 NEW	MS9025	VP05RT	VP10RT	VP15TF		UP20M	NX2525	NX3035	MP3025	AP25N	VP25N	VP45N	UTi20T	HTi10	RT9010	MT9005	MT9015		
R/L-F 	DCGT070202R-F	0.2																																						
	DCGT070202L-F	0.2																																					C025	
	DCGT070204R-F	0.4																																					D011	
	DCGT070204L-F	0.4																																				D026		
	DCGT11T302R-F	0.2																																					E010	
	DCGT11T302L-F	0.2																																				E011		
	DCGT11T304R-F	0.4																																					E031	
Finish Cutting	DCGT11T304L-F	0.4																																				E033		
R-SRF 	DCGT11T301MR-SRF	0.08																																				C025		
	DCGT11T302MR-SRF	0.18																																					D011	
	DCGT11T304MR-SRF	0.38																																					D026	
LP 	DCMT070204-LP	0.4				●	●	●																	●	★													C025	
	DCMT070208-LP	0.8				★	●	●																	★	★													D011	
	DCMT11T304-LP	0.4				●	●	●																	●	●													D026	
	DCMT11T308-LP	0.8				●	●	●																	★	●													E010	
LM 	DCMT070204-LM	0.4							●	●																													E011	
	DCMT070208-LM	0.8							●	●																													E031	
	DCMT11T304-LM	0.4							●	●																													E033	
	DCMT11T308-LM	0.8							●	●																													E033	
LS 	DCMT070202-LS	0.2																																					C025	
	DCMT070204-LS	0.4																																					D011	
	DCMT11T302-LS	0.2																																					D026	
	DCMT11T304-LS	0.4																																					E010	
	DCMT11T308-LS	0.8																																					E011	
Light Cutting	DCGT070201M-LS	0.08																																					C025	
	DCGT070202M-LS	0.18																																					D011	
	DCGT070204M-LS	0.38																																					D026	
	DCGT11T301M-LS	0.08																																					E010	
	DCGT11T302M-LS	0.18																																					E011	
Light Cutting	DCGT11T302M-LS	0.18																																						E031
	DCGT11T304M-LS	0.38																																					E033	

● = NEW

● : Inventory maintained. ★ : Inventory maintained in Japan.

TURNING INSERTS

A

7°

WITH HOLE

C

D

R

S

T

V

W

TURNING INSERTS [POSITIVE]



DCMT 07 02 04- MK

Size Thickness Corner Radius Chipbreaker
* Please refer to page A002.

CHIP CONTROL RANGE FOR WORK MATERIALS

Finish Cutting.....

Light Cutting.....

Medium Cutting.....

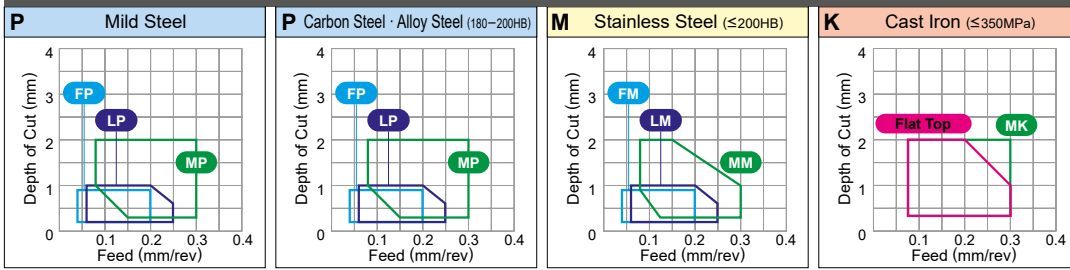

Cutting Conditions (Guide) : ● : Stable Cutting ● : General Cutting ⊕ : Unstable Cutting

Work Material	P Steel	M Stainless Steel	K Cast Iron	N Non-ferrous Metal	S Heat-resistant Alloy, Titanium Alloy	Coated																	Cermet	Coated Cermet	Carbide			Applicable Holder Page						
						UE6105	UE6110	MC6015	MC6025	UH6400	MS6015	MC7025	MP7035	US735	US905	MC5005	MC5015	MH515	MP9005	MP9015	MP9025	MS9025	VP05RT	VP10RT	VP15TF	UP20M	NX2525		NX3035	MP3025	AP25N	VP25N	VP45N	UT120T
	Medium Cutting	DCMT070204-MK	0.4									★●																				C025 D011 D026 E010 E011		
		DCMT070208-MK	0.8								★●																					E031 E033		
		DCMT11T304-MK	0.4																															
		DCMT11T308-MK	0.8																															
		DCMT150404-MK	0.4										★●																				E031 E033	
	Medium Cutting	DCMT150408-MK	0.8									★●																				E033		
		DCMT070204-MS	0.4												●●●																	C025 D011 D026 E010 E011 E031 E033		
		DCMT070208-MS	0.8												●●●																			
		DCMT11T304-MS	0.4												●●●																			
		DCMT11T308-MS	0.8												●●●																			
	Medium Cutting	DCMT11T312-MS	1.2											●●●																		E033		
		DCMT070202	0.2		●					●									●●	●●		●												
		DCMT070204	0.4	●●						●									●●	●●		●												
		DCMT070208	0.8	★						●									●●	●●		★											C025 D011 D026 E010 E011 E031 E033	
		DCMT11T302	0.2	●						●										●●	●●		●											
		DCMT11T304	0.4	●●						●										●●	●●		●											
		DCMT11T308	0.8	●●						●										●●	●●		★											
		DCMT11T312	1.2	★																														
		DCMT150404	0.4	●						●										●●	★	★				●								
	DCMT150408	0.8	●						●										●●	★				●										
	DCMT150412	1.2	●																															
	Medium Cutting	DCMT070202-MV	0.2	●	●				●										●	●★	●●	●										C025 D011 D026 E010 E011 E031 E033		
		DCMT070204-MV	0.4	●	●				●		●									●	●★	●●	★											
		DCMT070208-MV	0.8	●	●				●		●									●	★	●●	★											
		DCMT11T302-MV	0.2	●	●				●		●									●	●●	●●	●											
		DCMT11T304-MV	0.4	●	●				●		●									●	●●	●●	●											
	DCMT11T308-MV	0.8	●	●				●		●									●	●●	●●	●												
	Medium Cutting	DCET070204R-SR	0.4																★	★														
		DCET070202R-SR	0.2																	★	★													
		DCET070202L-SR	0.2																	★	★													
		DCET070204R-SR	0.4																	★	★													
		DCET070202L-SR	0.2																	★	★													
		DCET070201R-SR	0.1																	★	★													
		DCET070201L-SR	0.1																	★	★													
		DCET070204L-SR	0.4																	★	★													

= NEW

● : Inventory maintained. ★ : Inventory maintained in Japan.

TURNING INSERTS

POSITION 7°

WITH HOLE

C

D

R

S

T

V

W

TURNING INSERTS [POSITIVE]



DCET 11 T3 01 L-SN
 Size Thickness Corner Radius R/L Chipbreaker
 * Please refer to page A002.

CHIP CONTROL RANGE FOR WORK MATERIALS

Finish Cutting.....

Light Cutting.....

Medium Cutting.....

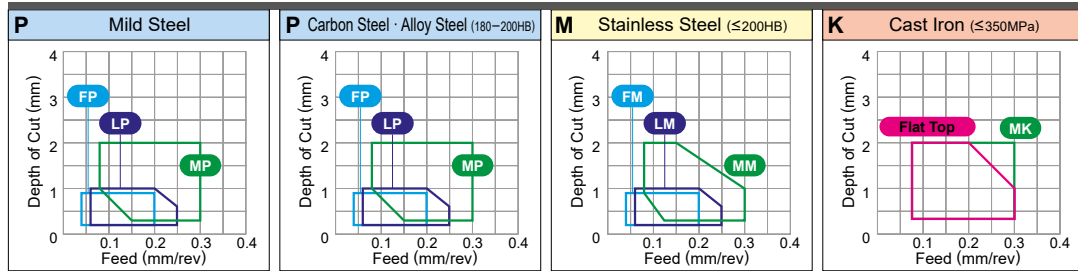

TURNING INSERTS

A

Cutting Conditions (Guide) : ● : Stable Cutting ● : General Cutting ✦ : Unstable Cutting

Work Material	Shape	Order Number	RE (mm)	Coated													Cermets	Coated Cermets	Carbide	Applicable Holder Page														
				UE6105	UE6110	MC6015	MC6025	UH6400	MS6015	MC7025	MP7035	US735	US905	MC5005	MC5015	MH515					MP9005	MP9015	MP9025	MS9025	VP05RT	VP10RT	VP15TF	UP20M	NX2525	NX3035	MP3025	AP25N	VP25N	VP45N
P Steel	R/L-SN	DCET11T301L-SN	0.1	●	●	●	●	●	●	●	●	●	●	●	●	●	●	●	●	●	●	●	●	●	●	●	●	●	●	●	●	●	●	C025
		DCET11T302R-SN	0.2																															D011
		DCET11T302L-SN	0.2																															D026
		DCET11T304R-SN	0.4																															E010
		DCET11T304L-SN	0.4																															E011
M Stainless Steel	Medium Cutting	DCET11T304L-SN	0.4																														E031	
		DCET11T304L-SN	0.4																															E033
		DCET0702V3RW-SN	0.03																															C025
		DCET0702V3LW-SN	0.03																															D011
		DCET11T3V3RW-SN	0.03																															D026
N Non-ferrous Metal	Medium Cutting (Wiper)	DCET11T3V3LW-SN	0.03																														E010	
		DCET11T3V3LW-SN	0.03																															E011
		DCET11T3V3LW-SN	0.03																															E031
		DCET11T3V3LW-SN	0.03																															E033
		DCET11T3V3LW-SN	0.03																															
S Heat-resistant Alloy, Titanium Alloy	SMG	DCGT070201M-SMG	0.08																														C025	
		DCGT070202M-SMG	0.18																															D011
		DCGT070204M-SMG	0.38																															D026
		DCGT11T301M-SMG	0.08																															E010
		DCGT11T302M-SMG	0.18																															E011
		DCGT11T304M-SMG	0.38																															E031
Flat Top	Medium Cutting	DCMW070204	0.4																														C025	
		DCMW11T304	0.4																														D011	
		DCMW11T308	0.8																															D026
		DCMW150404	0.4																															E010
		DCMW150408	0.8																															E011
Flat Top	Medium Cutting	DCMW150408	0.8																														E031	
		DCMW150408	0.8																														E031	
		DCMW150408	0.8																															E033
		DCGW070200	0																															C025
		DCGW0702V5	0.05																															
Flat Top	Medium Cutting	DCGW0702V5	0.05																														D026	
		DCGW11T300	0																														E010	
		DCGW11T3V5	0.05																															E011
		DCGW11T304	0.4																															E031
Flat Top	DCGW11T304	0.4																														E033		

* Please refer to page A028 before using the R/LW-SN breaker (wiper insert).

● = NEW

● : Inventory maintained. ★ : Inventory maintained in Japan.

□ : Non stock, produced to order only.

CHIP CONTROL RANGE FOR WORK MATERIALS

Finish Cutting.....

Medium Cutting.....

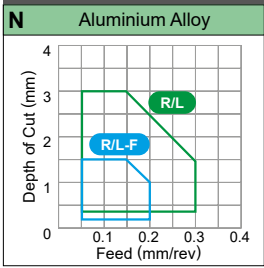

Cutting Conditions (Guide) : ● : Stable Cutting ● : General Cutting ✦ : Unstable Cutting

Work Material	P	Steel	●	●	●	✦	●																														
	M	Stainless Steel					●	●	●																												
K	Cast Iron								●	●	●																										
N	Non-ferrous Metal																																				
S	Heat-resistant Alloy, Titanium Alloy							●			●	●	✦	●																							
Shape	Order Number	RE (mm)	Coated										Cermet	Coated Cermet		Carbide		Applicable Holder Page																			
			UE6105	UE6110	MC6015	MC6025	UH6400	MS6015	MC7025	MP7035	US735	US905	MC5005	MC5015	MH515	MP9005	MP9015		MP9025	MS9025	VP05RT	VP10RT	VP15TF	UP20M	NX2525	NX3035	MP3025	AP25N	VP25N	VP45N	UTi20T	HTi10	RT9010	MT9005	MT9015		
R/L-F 	DEGX150402L-F	0.2																																			
	DEGX150404R-F	0.4																																			
	DEGX150404L-F	0.4																																			
R/L 	DEGX150402R	0.2																																			
	DEGX150402L	0.2																																			
	DEGX150404R	0.4																																			
	DEGX150404L	0.4																																			

● = NEW

A

TURNING INSERTS

POSI 20°

WITH HOLE

C

D

R

S

T

V

W

TURNING INSERTS [POSITIVE]

RC TYPE INSERTS WITH HOLE

RCGT 08 03 M0- AZ

Size Thickness Corner Radius Chipbreaker
* Please refer to page A002.

CHIP CONTROL RANGE FOR WORK MATERIALS

Medium Cutting.....

Heavy Cutting.....

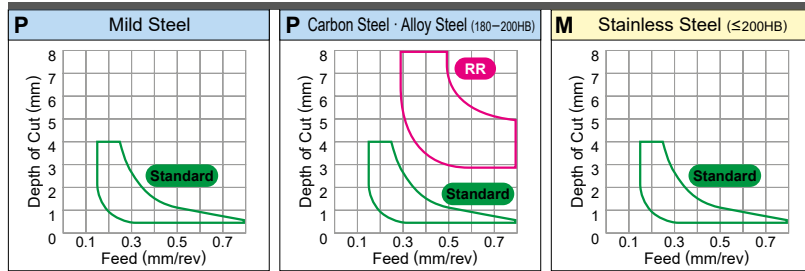

A

TURNING INSERTS

POSITIVE WITH HOLE

C

D

R

S

T

V

W

Cutting Conditions (Guide) : ● : Stable Cutting ● : General Cutting ✦ : Unstable Cutting

Work Material	P	Steel																																	
	M	Stainless Steel																																	
Shape	K	Cast Iron																																	
	N	Non-ferrous Metal																																	
	S	Heat-resistant Alloy, Titanium Alloy																																	
Order Number	IC (mm)	Coated										Cermet	Coated Cermet	Carbide	Applicable Holder Page																				
		UE6105	UE6110	MC6015	MC6025	UH6400	MS6015	MC7025	MP7035	US735	US905	MC5005	MC5015	MH515		MP9005	MP9015	MP9025	MS9025	VP05RT	VP10RT	VP15TF	UP20M	NX2525	NX3035	MP3025	AP25N	VP25N	VP45N	UTI20T	HT110	RT9010	MT9005	MT9015	
AZ Medium - Finish Cutting	RCGT0803M0-AZ	8.0																															●		
	RCGT10T3M0-AZ	10.0																															●		
Standard Medium Cutting	RCMT0602M0	6.0	●																						●	★	★				●		●		
	RCMT0803M0	8.0	●						●																	●	★	★				●		●	
	NEW RCMT10T3M0	10.0																																	
	NEW RCMT1204M0	12.0																																	
Standard Medium Cutting	NEW RCMT1606M0	16.0																																	
	RCMX1003M0	10.0		●	●				●											●					★	★	★								
	RCMX1204M0	12.0	★	●	●				●	●		●								★	●				★	★	★								
	RCMX1606M0	16.0	★	●	●	★			●	●										●	●														
	RCMX2006M0	20.0	●	●	●	★			●																										
	RCMX2507M0	25.0	★	★	●																														
RR Heavy Cutting	RCMX3209M0	32.0	★	★																															
	RCMX1606M0-RR	16.0	★		●	●			●																										
	RCMX2006M0-RR	20.0	●		●	●			●																										
	RCMX2507M0-RR	25.0	★		●	●			●																										
RCMX3209M0-RR	32.0	★																																	

● = NEW

● : Inventory maintained. ★ : Inventory maintained in Japan.

CHIP CONTROL RANGE FOR WORK MATERIALS

Finish Cutting.....

Light Cutting.....

Medium Cutting.....

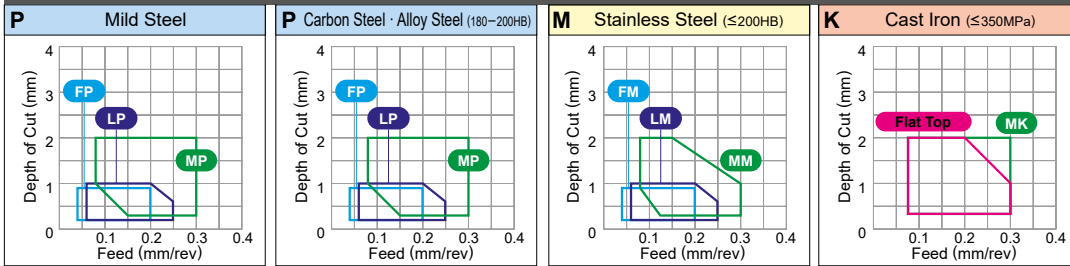

Cutting Conditions (Guide) : ● : Stable Cutting ● : General Cutting ✦ : Unstable Cutting

Work Material	Shape	Order Number	RE (mm)	Coated												Cermet	Coated Cermet		Carbide			Applicable Holder Page																	
				UE6105	UE6110	MC6015	MC6025	UH6400	MS6015	MC7025	MP7035	US735	US905	MC5005	MC5015	MH515	MP9005	MP9015	NEW MP9025	MS9025	VP05RT		VP10RT	VP15TF	UP20M	NX2525	NX3035	MP3025	AP25N	VP25N	VP45N	UT120T	HT110	RT9010	MT9005	MT9015			
Steel	FP	SCMT09T304-FP	0.4	★ ● ●																			★		★														C028 E035
		SCMT09T308-FP	0.8	★ ● ●																				★		★													
Stainless Steel	FM	SCMT09T304-FM	0.4																																				C028 E035
		SCMT09T308-FM	0.8																																				
Cast Iron	FV	SCMT09T304-FV	0.4																				★ ●		★		★												C028 E035
Non-ferrous Metal	LP	SCMT09T304-LP	0.4	● ● ●																				★		★												C028 E035	
		SCMT09T308-LP	0.8	★ ● ●																					●		★												
Heat-resistant Alloy, Titanium Alloy	LM	SCMT09T304-LM	0.4																																★ ★				C028 E035
		SCMT09T308-LM	0.8																																★ ★				
Medium Cutting	MP	SCMT09T304-MP	0.4	★ ● ●																					★		★												
		SCMT09T308-MP	0.8	● ● ●																						★		●											
		SCMT120404-MP	0.4	★ ● ●																						★		★											
		SCMT120408-MP	0.8	★ ● ●																						★		●											
Medium Cutting	MM	SCMT09T304-MM	0.4																																● ★				
		SCMT09T308-MM	0.8																															● ★					
		SCMT120404-MM	0.4																															● ★					
		SCMT120408-MM	0.8																															● ●					

● = NEW



TURNING INSERTS

TURNING INSERTS [POSITIVE]



90° SC TYPE INSERTS WITH HOLE

SCMT 09 T3 04- MK

Size Thickness Corner Radius Chipbreaker
* Please refer to page A002.

CHIP CONTROL RANGE FOR WORK MATERIALS

Finish Cutting.....

Light Cutting.....

Medium Cutting.....

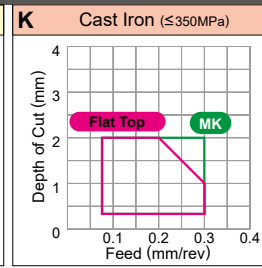
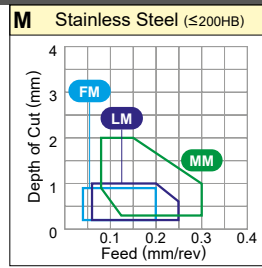
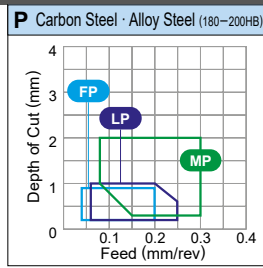
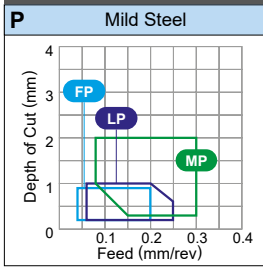

TURNING INSERTS

Cutting Conditions (Guide) : ● : Stable Cutting ● : General Cutting ✦ : Unstable Cutting

Work Material			Coated																									Cermet	Coated Cermet		Carbide		Applicable Holder Page			
	P Steel	M Stainless Steel	UE6105	UE6110	MC6015	MC6025	UH6400	MS6015	MC7025	MP7035	US735	US905	MC5005	MC5015	MH515	MP9005	MP9015	MP9025	MS9025	VP05RT	VP10RT	VP15TF	UP20M	NX2525	NX3035	MP3025	AP25N		VP25N	VP45N	UTI20T	HT110		RT9010	MT9005	MT9015
MK	SCMT09T304-MK	0.4												●	●																					
	SCMT09T308-MK	0.8												●	●																					
	SCMT120404-MK	0.4												✦	●																					
	SCMT120408-MK	0.8												●	●																					
MS	SCMT09T304-MS	0.4														●	●	●																		●
	SCMT09T308-MS	0.8														●	●	●																		●
	SCMT120404-MS	0.4														●	●	●																		●
	SCMT120408-MS	0.8														●	●	●																		●
Standard	SCMT09T304	0.4	✦	●																						●	●	★	★				●			
	SCMT09T308	0.8	●	●																						●	●	●	★				●			
	SCMT120404	0.4	●	●																						●	★	★								
	SCMT120408	0.8	●	●																						●	●	●	★				●			
	SCMT120412	1.2		●																																
Flat Top	SCMW09T304	0.4												●	●																		●	●		
	SCMW09T308	0.8												●	●																					
	SCMW120408	0.8												●	●																					

= NEW

● : Inventory maintained. ★ : Inventory maintained in Japan.

CHIP CONTROL RANGE FOR WORK MATERIALS

Medium Cutting..... ●

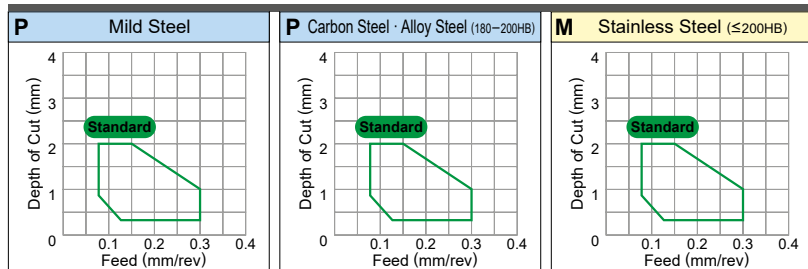

Cutting Conditions (Guide) : ● : Stable Cutting ● : General Cutting ✨ : Unstable Cutting

Work Material			Cutting Conditions (Guide) : ● : Stable Cutting ● : General Cutting ✨ : Unstable Cutting																																						
	P Steel	M Stainless Steel	K Cast Iron	N Non-ferrous Metal	S Heat-resistant Alloy, Titanium Alloy	UE6105	UE6110	MC6015	MC6025	UH6400	MS6015	MC7025	MP7035	US735	US905	MC5005	MC5015	MH515	MP9005	MP9015	MP9025	MS9025	VP05RT	VP10RT	VP15TF	UP20M	NX2525	NX3035	MP3025	AP25N	VP25N	VP45N	UTI20T	HT110	RT9010	MT9005	MT9015	Applicable Holder Page			
Shape	Order Number	RE (mm)	Coated														Cermet	Coated Cermet		Carbide																					
Standard 	SPMT090304	0.4																										●													
	SPMT090308	0.8																											●												
	SPMT120308	0.8																											●						●						
Medium Cutting 																																									
	Flat Top 	SPMW090304	0.4																										●	●						●	●				
		SPMW090308	0.8																										●	●	●					●	●				
		SPMW120304	0.4																										●	●						●	●				
SPMW120308		0.8																										●	●						●	●					
Flat Top 	SPGX090304	0.4																										●							●						
	SPGX090308	0.8																										●							●						
	SPGX120304	0.4																										●							●						
	SPGX120308	0.8																										●							●						

● = NEW

A

TURNING INSERTS

WITH HOLE

11°

C

D

R

S

T

V

W

TURNING INSERTS [POSITIVE]

60° TC TYPE INSERTS WITH HOLE

TCMT 09 02 02- FP

Size Thickness Corner Radius Chipbreaker
* Please refer to page A002.

CHIP CONTROL RANGE FOR WORK MATERIALS

Finish Cutting.....

Light Cutting.....

Medium Cutting.....

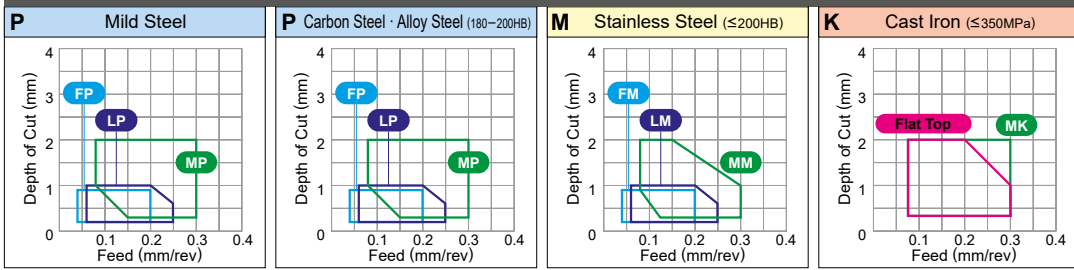







Cutting Conditions (Guide) : ● : Stable Cutting ● : General Cutting ✦ : Unstable Cutting

Work Material	Shape	Order Number	RE (mm)	Coated														Cermet	Coated Cermet	Carbide	Applicable Holder Page																					
				UE6105	UE6110	MC6015	MC6025	UH6400	MS6015	MC7025	MP7035	US735	US905	MC5005	MC5015	MH515	MP9005					MP9015	MP9025	MS9025	VP05RT	VP10RT	VP15TF	UP20M	NX2525	NX3035	MP3025	AP25N	VP25N	VP45N	UTi20T	HTi10	RT9010	MT9005	MT9015			
P Steel	FP	TCMT090202-FP	0.2	★ ● ●																																						
		TCMT090204-FP	0.4	★ ● ●																																						
		TCMT110202-FP	0.2	★ ● ●																																						
		TCMT110204-FP	0.4	● ● ●																																						
		TCMT16T304-FP	0.4	● ● ●																																						
M Stainless Steel	FM	TCMT090202-FM	0.2																																							
		TCMT090204-FM	0.4																																							
		TCMT110202-FM	0.2																																							
		TCMT110204-FM	0.4																																							
		TCMT16T304-FM	0.4																																							
K Cast Iron	FV	TCMT110204-FV	0.4																				● ●		● ●																	
		TCMT16T304-FV	0.4																					● ●		● ●																
P Steel	AZ	TCGT110202-AZ	0.2																																							
		TCGT110204-AZ	0.4																																							
		TCGT110208-AZ	0.8																																							
		TCGT16T302-AZ	0.2																																							
		TCGT16T304-AZ	0.4																																							
		TCGT16T308-AZ	0.8																																							
P Steel	R/L-F	TCGT0601V3L-F	0.03																				★																			
		TCGT060101L-F	0.1																					●	●																	
		TCGT060102R-F	0.2																					★	★																	
		TCGT060102L-F	0.2																						●	●																
		TCGT060104R-F	0.4																						●	●																
		TCGT060104L-F	0.4																						●	●																
		NEW TCGT060101MR-F	0.08																																							
		NEW TCGT060101ML-F	0.08																																							
		NEW TCGT060102MR-F	0.18																																							
		NEW TCGT060102ML-F	0.18																																							
NEW TCGT060104MR-F	0.38																																									
NEW TCGT060104ML-F	0.38																																									

● = NEW

● : Inventory maintained. ★ : Inventory maintained in Japan.

Cutting Conditions (Guide) : ● : Stable Cutting ● : General Cutting ✖ : Unstable Cutting

Work Material	P	Steel	●	●	●	✖	●																											
	M	Stainless Steel					●	●	●					●											●	●								
	K	Cast Iron							●					●											●	●								
S	N	Non-ferrous Metal																							●									
	S	Heat-resistant Alloy, Titanium Alloy								●																		●						
Shape	Order Number	RE (mm)	Coated													Cermet	Coated Cermet			Carbide			Applicable Holder Page											
			UE6105	UE6110	MC6015	MC6025	UH6400	MS6015	MC7025	MP7035	US735	US905	MC5005	MC5015	MH515	MP9005	MP9015	MP9025	MS9025	VP05RT	VP10RT	VP15TF		UP20M	NX2525	NX3035	MP3025	AP25N	VP25N	VP45N	UT120T	HT110	RT9010	MT9005
	LP	TCMT090204-LP	0.4	★	●	●																	★		●									
		TCMT090208-LP	0.8	★	●	●																		★		★								
		TCMT110204-LP	0.4	★	●	●																		●		★								
		TCMT110208-LP	0.8	★	●	●																		★		★								
		TCMT16T304-LP	0.4	★	●	●																		★		●								
		TCMT16T308-LP	0.8	★	●	●																		★		★								
	LM	TCMT090204-LM	0.4					●	★													●												
		TCMT090208-LM	0.8					★	★																★									
		TCMT110204-LM	0.4					●	●																	●								
		TCMT110208-LM	0.8					●	●																	●								
		TCMT16T304-LM	0.4					●	★																	●								
		TCMT16T308-LM	0.8					●	★																	●								
	LS	TCMT090202-LS	0.2																														●	
		TCMT110202-LS	0.2														●	●	●														●	
	MP	TCMT090204-MP	0.4	★	●	●																	★		★									
		TCMT090208-MP	0.8	★	●	●																		★		★								
		TCMT110204-MP	0.4	●	●	●																		★		●								
		TCMT110208-MP	0.8	★	●	●																		★		★								
		TCMT130304-MP	0.4	★	●	●																		★		★								
		TCMT16T304-MP	0.4	●	●	●																		★		★								
		TCMT16T308-MP	0.8	●	●	●																		●		●								
		TCMT16T312-MP	1.2	★	●	●																		★		★								
	MM	TCMT090204-MM	0.4					●	★																									
		TCMT090208-MM	0.8					★	★																									
		TCMT110204-MM	0.4					●	●																	●								
		TCMT110208-MM	0.8					●	★																	●								
		TCMT130304-MM	0.4					★	★																	★								
		TCMT16T304-MM	0.4					●	●																	●								
		TCMT16T308-MM	0.8					●	●																	●								
		TCMT16T312-MM	1.2					●	●																	●								
	MK	TCMT110204-MK	0.4								★	●																						
		TCMT110208-MK	0.8								★	●																						
		TCMT16T304-MK	0.4								●	●																						
		TCMT16T308-MK	0.8								●	●																						
		TCMT16T312-MK	1.2								★	●																						
	MS	TCMT090204-MS	0.4													●	●	●															●	
		TCMT090208-MS	0.8													●	●	●															●	
		TCMT110204-MS	0.4													●	●	●															●	
		TCMT110208-MS	0.8													●	●	●															●	
		TCMT16T304-MS	0.4													●	●	●															●	
		TCMT16T308-MS	0.8													●	●	●															●	

● = NEW

CHIPBREAKERS > A058
 GRADES > A030
 IDENTIFICATION > A002

A

TURNING INSERTS

POSI 7°

WITH HOLE

C

D

R

S

T

V

W

TURNING INSERTS [POSITIVE]

60° TC TYPE INSERTS WITH HOLE

TCMT 08 02 04

Size Thickness Corner Radius
* Please refer to page A002.

CHIP CONTROL RANGE FOR WORK MATERIALS

Finish Cutting.....

Light Cutting.....

Medium Cutting.....

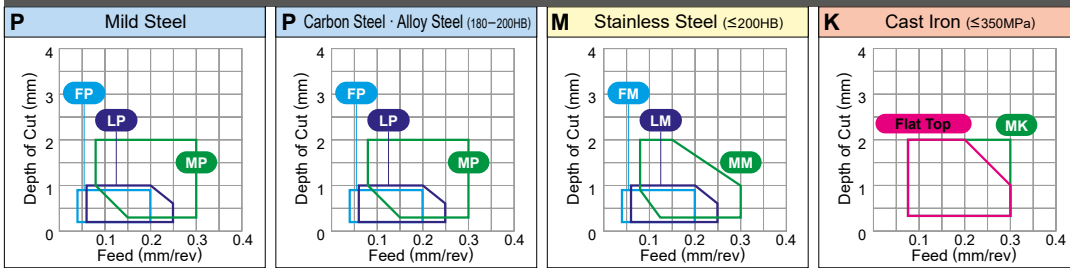

Cutting Conditions (Guide) : ● : Stable Cutting ● : General Cutting ✦ : Unstable Cutting

Work Material	P	M	K	N	S	Coated															Cermet	Coated Cermet	Carbide	Applicable Holder Page																
	Steel	Stainless Steel	Cast Iron	Non-ferrous Metal	Heat-resistant Alloy, Titanium Alloy	UE6105	UE6110	MC6015	UH6400	MS6015	MC7025	MP7035	US735	US905	MC5005	MC5015	MH515	MP9005	MP9015	MP9025	MS9025	VP05RT	VP10RT		VP15TF	UP20M	NX2525	NX3035	MP3025	AP25N	VP25N	VP45N	UTI20T	HT110	RT9010	MT9005	MT9015			
Standard	TCMT080204	0.4																																						
	TCMT090204	0.4	●										★														●	●	●	●	●									
	TCMT110202	0.2	●										●														●	●	●	●	●									
	TCMT110204	0.4	★	●									●														●	●	●	●	●									
	TCMT110208	0.8	★	●																							●	●	●	●	●									
	TCMT130302	0.2																										●	●	●	●	●								
	TCMT130304	0.4	●										●														●	●	●	●	●									
	TCMT16T304	0.4	●	●									●														●	●	●	●	●									
	TCMT16T308	0.8	●	●									●														●	●	●	●	●									
	TCMT16T312	1.2	●																																					
Flat Top	TCMW110204	0.4												●	●																									
	TCMW130304	0.4																																						
	TCMW16T304	0.4													●	●																								
	TCMW16T308	0.8													●	●																								
	TCMW16T312	1.2													★	★																								

● = NEW

● : Inventory maintained. ★ : Inventory maintained in Japan.

CHIP CONTROL RANGE FOR WORK MATERIALS

Medium Cutting.....

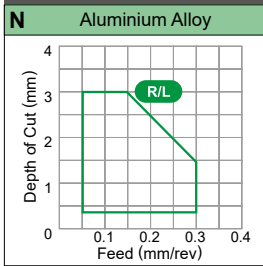

Cutting Conditions (Guide) : ● : Stable Cutting ● : General Cutting ✦ : Unstable Cutting

Work Material	P	Steel	●	●	●	✦	✦	●											Applicable Holder Page		
	M	Stainless Steel					●	●	●	●	●	●	●	●	●	●	●	●			
Work Material	K	Cast Iron							●	●	●										
	N	Non-ferrous Metal																			
Work Material	S	Heat-resistant Alloy, Titanium Alloy						●	●	●	✦	●	●	●	●	●	●	●	●		
	Shape	Order Number	RE (mm)	Coated										Cermet	Coated Cermet		Carbide				
R/L	TEGX160302R	0.2																			
Medium Cutting (For Aluminium Alloy)	TEGX160302L	0.2																			
	TEGX160304R	0.4																			
	TEGX160304L	0.4																			

● = NEW

TURNING INSERTS

A

POSI 20° WITH HOLE

C

D

R

S

T

V

W

TURNING INSERTS [POSITIVE]

60° TP TYPE INSERTS WITH HOLE

TPMH 08 02 02-FV

Size Thickness Corner Radius Chipbreaker
* Please refer to page A002.

CHIP CONTROL RANGE FOR WORK MATERIALS

Finish Cutting.....●

Light Cutting.....●

Medium Cutting.....●

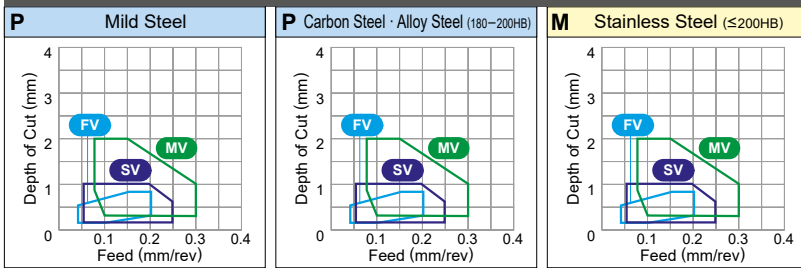

Cutting Conditions (Guide) : ●: Stable Cutting ●: General Cutting ✦: Unstable Cutting

Work Material			Coated															Cermets		Coated Cermets		Carbide		Applicable Holder Page												
	P	M	UE6105	UE6110	MC6015	MC6025	UH6400	MS6015	MC7025	MP7035	US735	US905	MC5005	MC5015	MH515	MP9005	MP9015	MP9025	MS9025	VP05RT	VP10RT	VP15TF	UP20M		NX2525	NX3035	MP3025	AP25N	VP25N	VP45N	UT120T	HT110	RT9010	MT9005	MT9015	
FV																																				
	TPMH080202-FV	0.2	●	●	●	●	●	●	●	●	●	●	●	●	●	●	●	●	●	●	●	●	●	●	●	●	●	●								
	TPMH080204-FV	0.4																																		
	TPMH090202-FV	0.2																																		
	TPMH090204-FV	0.4																																		
	TPMH110302-FV	0.2																																		
	TPMH110304-FV	0.4																																		
	TPMH110308-FV	0.8																																		
Finish Cutting	TPMH160302-FV	0.2																																		
	TPMH160304-FV	0.4																																		
	TPMH160308-FV	0.8																																		
	TPGH080202R-FS	0.2																																		
	TPGH080202L-FS	0.2																																		
	TPGH080204R-FS	0.4																																		
	TPGH080204L-FS	0.4																																		
	TPGH090202R-FS	0.2																																		
Finish Cutting	TPGH090202L-FS	0.2																																		
	TPGH090204R-FS	0.4																																		
	TPGH090204L-FS	0.4																																		
	TPGH110302R-FS	0.2																																		
	TPGH110302L-FS	0.2																																		
	TPGH110304R-FS	0.4																																		
	TPGH110304L-FS	0.4																																		
	TPGH160304R-FS	0.4																																		
Finish Cutting	TPGH160304L-FS	0.4																																		
	TPGH160308R-FS	0.8																																		
	TPGH160308L-FS	0.8																																		
	TPGX080202R	0.2																																		
	TPGX080202L	0.2																																		
	TPGX080204R	0.4																																		
	TPGX080204L	0.4																																		
	TPGX090202R	0.2																																		
Finish Cutting	TPGX090202L	0.2																																		
	TPGX090204R	0.4																																		
	TPGX090204L	0.4																																		
	TPGX090208R	0.8																																		
	TPGX090208L	0.8																																		

● = NEW

● : Inventory maintained. ★ : Inventory maintained in Japan.

TURNING INSERTS

A

POSI
11°

WITH
HOLE

C

D

R

S

T

V

W



E009

E009

E009

E027

TURNING INSERTS [POSITIVE]



35° VB TYPE INSERTS WITH HOLE

VBMT 11 03 02-FP

Size Thickness Corner Radius Chipbreaker
* Please refer to page A002.

CHIP CONTROL RANGE FOR WORK MATERIALS

Finish Cutting.....

Light Cutting.....



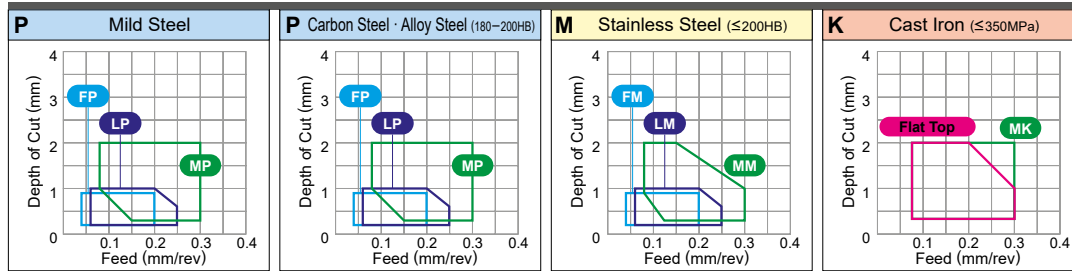



Medium Cutting.....



TURNING INSERTS

A









Cutting Conditions (Guide) : ● : Stable Cutting ● : General Cutting ✦ : Unstable Cutting

Work Material	P	Steel	Coated														Cermet	Coated Cermet	Carbide	Applicable Holder Page														
	M	Stainless Steel	UE6105	UE6110	MC6015	MC6025	UH6400	MS6015	MC7025	MP7035	US735	US905	MC5005	MC5015	MH515	MP9005	MP9015	MP9025	MS9025		VP05RT	VP10RT	VP15TF	UP20M	NX2525	NX3035	MP3025	AP25N	VP25N	VP45N	UTI20T	HT110	RT9010	MT9005
FP 	VBMT110302-FP	0.2	●	●	●																			●	●									
	VBMT110304-FP	0.4	●	●	●																				●	●								
	VBMT110308-FP	0.8	★	●	●																				★	★								
	VBMT160404-FP	0.4	●	●	●																				●	●								
	VBMT160408-FP	0.8	●	●	●																				●	●								
FM 	VBMT110302-FM	0.2																				●												
	VBMT110304-FM	0.4																				●												
	VBMT110308-FM	0.8																				★												
	VBMT160404-FM	0.4																				●												
FV 	VBMT110304-FV	0.4																				●	●	★										
	VBMT110308-FV	0.8																				●	●	★										
	VBMT160404-FV	0.4																				●	●	★										
	VBMT160408-FV	0.8																				●	●	★										
R/L-F 	VBGT110302R-F	0.2																				●	★	★	★				★					
	VBGT110302L-F	0.2																				●	★	●	★				★					
	VBGT110304R-F	0.4																				●	★	★				★						
	VBGT110304L-F	0.4																				●	★	★				★						
	VBGT160402R-F	0.2																				●	★	★				★						
	VBGT160402L-F	0.2																				●	★	★				★						
	VBGT160404R-F	0.4																				●	★	★				★						
VBGT160404L-F	0.4																				●	★	★				★							
LP 	VBMT110304-LP	0.4	★	●	●																			★	●									
	VBMT110308-LP	0.8	●	●	●																				●	★								
	VBMT160404-LP	0.4	●	●	●																				●	●								
	VBMT160408-LP	0.8	●	●	●																				●	●								
LM 	VBMT110304-LM	0.4						●	●													●												
	VBMT110308-LM	0.8						★	★														●											
	VBMT160404-LM	0.4						●	●														●											
	VBMT160408-LM	0.8						●	★														●											

● = NEW

● : Inventory maintained. ★ : Inventory maintained in Japan.

Cutting Conditions (Guide) : ● : Stable Cutting ● : General Cutting ✖ : Unstable Cutting

Work Material	P	Steel	●	●	●	✖	●																											
	M	Stainless Steel					●	●	●																									
	K	Cast Iron							●	●																								
	N	Non-ferrous Metal																																
	S	Heat-resistant Alloy, Titanium Alloy							●	●	●	●																						
Shape	Order Number	RE (mm)	Coated													Cermet	Coated Cermet	Carbide	Applicable Holder Page															
			UE6105	UE6110	MC6015	MC6025	UH6400	MS6015	MC7025	MP7035	US735	US905	MC5005	MC5015	MH515	MP9005	MP9015	MP9025		MS9025	VP05RT	VP10RT	VP15TF	UP20M	NX2525	NX3035	MP3025	AP25N	VP25N	VP45N	UTI20T	HT110	RT9010	MT9005
 Light Cutting	VBMT110302-LS	0.2															●																●	E013 H013
	VBMT110304-LS	0.4															●																●	
	VBMT110308-LS	0.8															●																●	
	VBMT160404-LS	0.4															●																●	
	VBMT160408-LS	0.8															●																●	
 Light Cutting	VBMT110304-SV	0.4																		●				★									D010 D011 E013 E014 H013	
	VBMT110308-SV	0.8																		●				●										
	VBMT160404-SV	0.4																		●				●										
	VBMT160408-SV	0.8																		●				●										
 Medium Cutting	VBMT160404-MP	0.4		●	●	●																		★		●							E013 H013	
	VBMT160408-MP	0.8		●	●	●																			★		★							
 Medium Cutting	VBMT160404-MM	0.4						●	●															●									E013 H013	
	VBMT160408-MM	0.8						●	●															●										
 Medium Cutting	VBMT160404-MK	0.4												★	★																		E013 H013	
	VBMT160408-MK	0.8												★	★																			
 Medium Cutting	VBMT160402-MS	0.2															●	●	●													●	E013 H013	
	VBMT160404-MS	0.4															●	●	●													●		
	VBMT160408-MS	0.8															●	●	●													●		
	VBMT160412-MS	1.2															●	●	●													●		
 Medium Cutting	VBMT160404	0.4		●																													E013 H013	
	VBMT160408	0.8		●																														
 Medium Cutting	VBMT110304-MV	0.4			●				●		●										●		●	★	●	●	●	★					D012 D013 E013 E014 H013	
	VBMT110308-MV	0.8			●				★		●										●		●	★	★	●	●	★						
	VBMT160404-MV	0.4		●	●	●			●		●											●		●	●	●	●	●						
	VBMT160408-MV	0.8		●	●	●			●		●											●		●	★	●	●	●	★					

● = NEW

CHIPBREAKERS > A054
GRADES > A030
IDENTIFICATION > A002

A

TURNING INSERTS

POSI
5°

WITH
HOLE

C

D

R

S

T

V

W

TURNING INSERTS [POSITIVE]



35° VB TYPE INSERTS WITH HOLE

VBET 11 03 V3 R- SR

Size Thickness Corner Radius R/L Chipbreaker
* Please refer to page A002.

CHIP CONTROL RANGE FOR WORK MATERIALS

Finish Cutting.....

Light Cutting.....

Medium Cutting.....

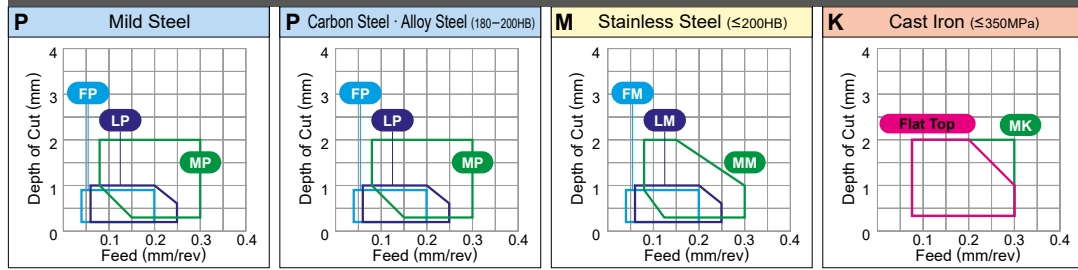

TURNING INSERTS

A

Cutting Conditions (Guide) : ● : Stable Cutting ● : General Cutting ✱ : Unstable Cutting

Work Material			Coated												Cermet	Coated Cermet	Carbide	Applicable Holder Page																						
	P Steel	M Stainless Steel	UE6105	UE6110	MC6015	MC6025	UH6400	MS6015	MC7025	MP7035	US735	US905	MC5005	MC5015	MH515	NEW	MP9005		MP9015	NEW	MS9025	VP05RT	VP10RT	VP15TF	UP20M	NX2525	NX3035	MP3025	AP25N	VP25N	VP45N	UT120T	HT110	RT9010	MT9005	MT9015				
R/L-SR	VBET1103V3R-SR	0.03																																						
	VBET1103V3L-SR	0.03																																						
	VBET110301R-SR	0.1																																						
	VBET110301L-SR	0.1																																						
	VBET110302R-SR	0.2																																						
	VBET110302L-SR	0.2																																						
	VBET110304R-SR	0.4																																						
Medium Cutting	VBET110304L-SR	0.4																																						
	R/L-SN	VBET110300R-SN	0																																					
		VBET110300L-SN	0																																					
		VBET1103V3R-SN	0.03																																					
		VBET1103V3L-SN	0.03																																					
		VBET110301R-SN	0.1																																					
		VBET110301L-SN	0.1																																					
VBET110302R-SN		0.2																																						
Medium Cutting	VBET110302L-SN	0.2																																						
	VBET110304R-SN	0.4																																						
	VBET110304L-SN	0.4																																						
	R/LW-SN *	VBET1103V3RW-SN	0.03																																					
		VBET1103V3LW-SN	0.03																																					
	Medium Cutting (Wiper)																																							
		Flat Top	VBMW160408	0.8										★	★																									

* Please refer to page A028 before using the R/LW-SN breaker (wiper insert).



● : Inventory maintained. ★ : Inventory maintained in Japan.



35° VC TYPE INSERTS WITH HOLE

VCMT 11 03 02- FP

Size Thickness Corner Radius Chipbreaker
 * Please refer to page A002.

CHIP CONTROL RANGE FOR WORK MATERIALS

Finish Cutting.....●

Light Cutting.....●

Medium Cutting.....●

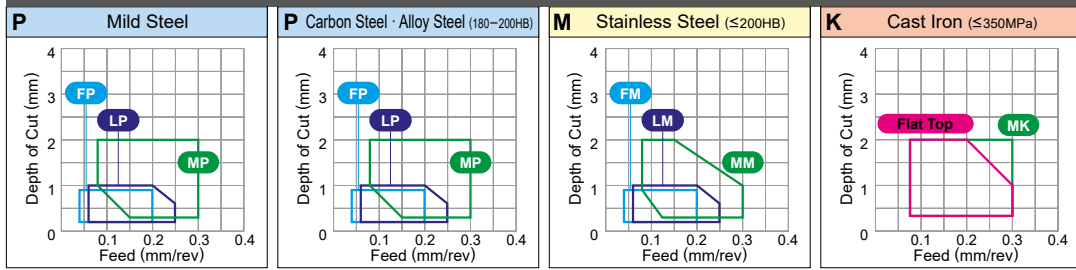

Cutting Conditions (Guide) : ● : Stable Cutting ● : General Cutting ⊕ : Unstable Cutting

Work Material	P	Steel	● ● ● ⊕ ● ●																																
	M	Stainless Steel	● ● ⊕ ● ●	● ● ● ●																															
	K	Cast Iron	● ● ● ●	● ● ● ●	● ● ● ●																														
	N	Non-ferrous Metal																																	
	S	Heat-resistant Alloy, Titanium Alloy	●																																
Shape	Order Number	RE (mm)	Coated									Cermet	Coated Cermet		Carbide			Applicable Holder Page																	
			UE6105	UE6110	MC6015	MC6025	UH6400	MS6015	MC7025	MP7035	US735		US905	MC5005	MC5015	MH515	MP9005		MP9015	MP9025	MS9025	VP05RT	VP10RT	VP15TF	UP20M	NX2525	NX3035	MP3025	AP25N	VP25N	VP45N	UTI20T	HT110	RT9010	MT9005
FP Finish Cutting	VCMT110302-FP	0.2	● ● ●																																C030
	VCMT110304-FP	0.4	● ● ●																																C031
	VCMT160404-FP	0.4	● ● ●																																D013
	VCMT160408-FP	0.8	● ● ●																					★										E034	
FM Finish Cutting	VCMT110302-FM	0.2																																C030	
	VCMT110304-FM	0.4																																C031	
	VCMT160404-FM	0.4																																D013	
	VCMT160408-FM	0.8																						★										E034	
FV Finish Cutting	VCMT080202-FV	0.2			●																	●	★	★									C030		
	VCMT080204-FV	0.4			●																	●	★	★									C031		
	VCMT160404-FV	0.4		●																		●	●	●		●							E013		
	VCMT160408-FV	0.8		●																		●	●	●		●							E014		
AZ Medium - Finish Cutting	VCGT160404-AZ	0.4																																C030	
	VCGT160408-AZ	0.8																																C031	
	VCGT160412-AZ	1.2																																E034	
R/L-F Finish Cutting	VCGT080202R-F	0.2																				●	★	★											
	VCGT080202L-F	0.2																				●	★	★											
	VCGT080204R-F	0.4																				●	★	★										E013	
	VCGT080204L-F	0.4																				●	★	★										E014	
LP Light Cutting	VCMT110304-LP	0.4	★ ● ●																			●	●											C030	
	VCMT110308-LP	0.8	★ ● ●																			●	●											C031	
	VCMT160404-LP	0.4	● ● ●																			●	●											D013	
	VCMT160408-LP	0.8	★ ● ●																			★	★											E034	
LM Light Cutting	VCMT110304-LM	0.4						● ●														●												C030	
	VCMT110308-LM	0.8						● ●														●												C031	
	VCMT160404-LM	0.4						● ●														●												D013	
	VCMT160408-LM	0.8						● ★														●												E034	

● = NEW

TURNING INSERTS

A

7° POSI
WITH HOLE

C
D
R
S
T
V
W

TURNING INSERTS [POSITIVE]



35° VC TYPE INSERTS WITH HOLE

VCMT 11 03 02- LS

Size Thickness Corner Radius Chipbreaker
* Please refer to page A002.

CHIP CONTROL RANGE FOR WORK MATERIALS

Finish Cutting.....

Light Cutting.....

Medium Cutting.....

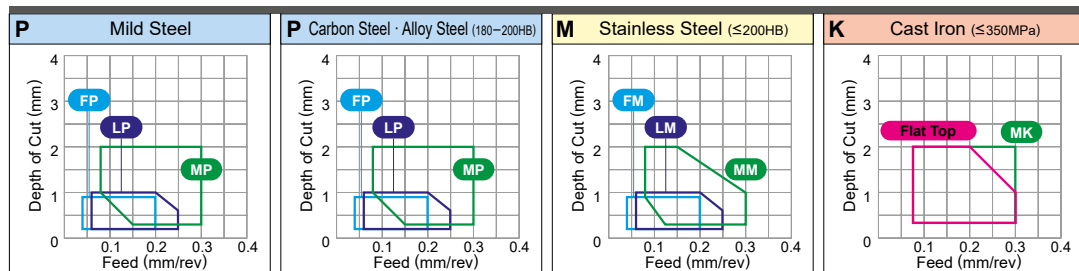





Cutting Conditions (Guide) : ●: Stable Cutting ●: General Cutting ✚: Unstable Cutting

Work Material	P Steel		M Stainless Steel		K Cast Iron		N Non-ferrous Metal		S Heat-resistant Alloy, Titanium Alloy																												
	Coated	Cermet	Coated Cermet	Carbide	Applicable Holder Page																																
Shape	Order Number	RE (mm)	Coated		Cermet	Coated Cermet	Carbide	Applicable Holder Page																													
			UE6105	UE6110	MC6015	MC6025	UH6400	MS6015	MC7025	MP7035	US735	US905	MC5005	MC5015	MH515 NEW	MP9005	MP9015	MP9025 NEW	MS9025	VP05RT	VP10RT	VP15TF	UP20M	NX2525	NX3035	MP3025	AP25N	VP25N	VP45N	UTi20T	HTi10	RT9010	MT9005	MT9015			
 Light Cutting	VCMT110302-LS	0.2																																			
	VCMT110304-LS	0.4																																			
	VCMT160404-LS	0.4																																			
	VCMT160408-LS	0.8																																			
 Light Cutting	VCGT110301M-LS	0.08																																			
	VCGT110302M-LS	0.18																																			
	VCGT110304M-LS	0.38																																			
	VCGT130301M-LS	0.08																																			
	VCGT130302M-LS	0.18																																			
 Light Cutting	VCGT110301M-LS-P	0.08																																			
	VCGT110302M-LS-P	0.18																																			
	VCGT110304M-LS-P	0.38																																			
	VCGT130301M-LS-P	0.08																																			
 Light Cutting	VCMT080202-SV	0.2			●																																
	VCMT080204-SV	0.4			●																																
 Medium Cutting	VCMT160404-MP	0.4			●●●																																
	VCMT160408-MP	0.8			●●●																																
	VCMT160412-MP	1.2			★●●																																
 Medium Cutting	VCMT160404-MM	0.4							●●																												
	VCMT160408-MM	0.8							●●																												
	VCMT160412-MM	1.2							★★																												

● = NEW

●: Inventory maintained. ★: Inventory maintained in Japan.

Cutting Conditions (Guide) : ● : Stable Cutting ● : General Cutting ✳ : Unstable Cutting

Work Material	P	Steel	●	●	●	✳	●																										
	M	Stainless Steel					●	●						●			●	●	●	●													
Work Material	K	Cast Iron						●	●	●							●	●	●	●													
	N	Non-ferrous Metal																●	●	●													
	S	Heat-resistant Alloy, Titanium Alloy						●		●	●	●	●	●	●				●	●													
Shape	Order Number	RE (mm)	Coated											Cermet	Coated Cermet			Carbide			Applicable Holder Page												
			UE6105	UE6110	MC6015	MC6025	UH6400	MS6015	MC7025	MP7035	US735	US905	MC5005	MC5015	MH515	MP9005	MP9015	MP9025	MS9025	VP05RT		VP10RT	VP15TF	VP20M	NX2525	NX3035	MP3025	AP25N	VP25N	VP45N	UT120T	HT110	RT9010
MK  Medium Cutting	VCMT160404-MK	0.4										●	●	★																			
	VCMT160408-MK	0.8										●	●																				
MS  Medium Cutting	NEW VCMT110302-MS	0.2												●	●	●																	
	NEW VCMT110304-MS	0.4												●	●	●															●		
	NEW VCMT110308-MS	0.8												●	●	●														●			
	VCMT160404-MS	0.4												●	●	●														●			
	VCMT160408-MS	0.8												●	●	●														●			
Standard  Medium Cutting	VCMT110304	0.4		●							●								●	●	●	●	★			★	★						
	VCMT160404	0.4	●	●						●									●	●	●	●	★			●	★						
	VCMT160408	0.8	●	●						●									●	●	●	●	★			●							
	VCMT160412	1.2		●						●									●	★													
MV  Medium Cutting	VCMT080202-MV	0.2				●			●										●	●	★	★	●	★	●	★							
	VCMT080204-MV	0.4				●			●		●									●	●	★	★	●	★	●	★						
Flat Top  Medium Cutting	VCMW110304	0.4																												●			
	VCMW160404	0.4									●	●																		●			
	VCMW160408	0.8									●	●	★																	●			

● = NEW

A

TURNING INSERTS

POSI
 7°
 WITH HOLE

C

D

R

S

T

V

W

CHIPBREAKERS > A058
 GRADES > A030
 IDENTIFICATION > A002

TURNING INSERTS [POSITIVE]



35° VD TYPE INSERTS WITH HOLE

VDGX 16 03 02 R

Size Thickness Corner Radius R/L
* Please refer to page A002.

CHIP CONTROL RANGE FOR WORK MATERIALS

Medium Cutting..... ●

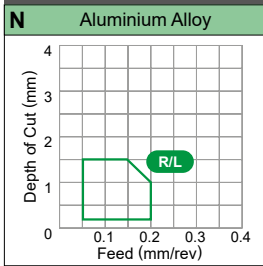

A

TURNING INSERTS

Cutting Conditions (Guide) : ● : Stable Cutting ● : General Cutting ✦ : Unstable Cutting

Work Material	P	Steel	●	●	●	✦	✦	✦	●	Coated	Cermet	Coated Cermet	Carbide	Applicable Holder Page																								
	M	Stainless Steel	●	●	●	✦	✦	✦	●																													
K	Cast Iron	●	●	●	●	●	●	●	●	NEW	NEW	NEW	NEW	NEW																								
N	Non-ferrous Metal	●	●	●	●	●	●	●	●																													
S	Heat-resistant Alloy, Titanium Alloy	●	●	●	●	●	●	●	●																													
Shape	Order Number	RE (mm)	UE6105	UE6110	MC6015	UH6400	MS6015	MC7025	MP7035	US735	US905	MC5005	MC5015	MH515	MP9005	MP9015	MP9025	MS9025	VP05RT	VP10RT	VP15TF	UP20M	NX2525	NX3035	MP3025	AP25N	VP25N	VP45N	UTI20T	HT110	RT9010	MT9005	MT9015					
R/L 	VDGX160302R	0.2																																				
	VDGX160302L	0.2																																				
	VDGX160304R	0.4																																				
	VDGX160304L	0.4																																				

● = NEW

● : Inventory maintained. ★ : Inventory maintained in Japan.

POSI 15°

WITH HOLE

C

D

R

S

T

V

W



35° VP TYPE INSERTS WITH HOLE

VPET 08 02 01 R- SRF
 Size Thickness Corner Radius R/L Chipbreaker
 * Please refer to page A002.



CHIP CONTROL RANGE FOR WORK MATERIALS

Finish Cutting.....●

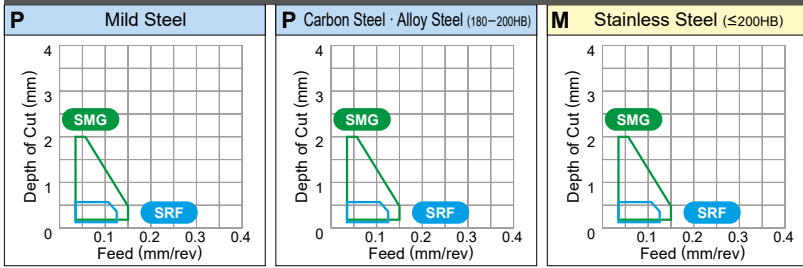
Medium Cutting.....●



Cutting Conditions (Guide) : ● : Stable Cutting ● : General Cutting ✨ : Unstable Cutting

Work Material	P	Steel	● ● ● ● ✨ ●											● ● ● ● ✨ ●	● ● ● ● ✨ ●	● ● ● ● ✨ ●	● ● ● ● ✨ ●	● ● ● ● ✨ ●																									
	M	Stainless Steel	● ● ● ● ✨ ●											● ● ● ● ✨ ●	● ● ● ● ✨ ●	● ● ● ● ✨ ●	● ● ● ● ✨ ●	● ● ● ● ✨ ●	● ● ● ● ✨ ●																								
	K	Cast Iron												● ● ● ● ✨ ●	● ● ● ● ✨ ●	● ● ● ● ✨ ●	● ● ● ● ✨ ●	● ● ● ● ✨ ●	● ● ● ● ✨ ●																								
Shape	Order Number	RE (mm)	Coated										Cermet	Coated Cermet	Carbide	Applicable Holder Page																											
			UE6105	UE6110	MC6015	UH6400	MS6015	MC7025	MP7035	US735	US905	MC5005	MC5015	MH515 NEW	MP9005		MP9015	MP9025 NEW	MS9025	VP05RT	VP10RT	VP15TF	UP20M	NX2525	NX3035	MP3025	AP25N	VP25N	VP45N	UTI20T	HT110	RT9010	MT9005	MT9015									
	VPET080201R-SRF	0.1																																									D012 D013
	VPET080201L-SRF	0.1																																									
	VPET080202R-SRF	0.2																																									
	VPET080202L-SRF	0.2																																									
	VPET1103V3R-SRF	0.03																																									
	VPET1103V3L-SRF	0.03																																									
	VPET110301R-SRF	0.1																																									
	VPET110301L-SRF	0.1																																									
	VPET110302R-SRF	0.2																																									
Finish Cutting	VPET110302L-SRF	0.2																																									
	VPGT080201M-SMG	0.1																																						D012 D013			
	VPGT080202M-SMG	0.2																																									
	VPGT110301M-SMG	0.1																																									
	VPGT110302M-SMG	0.2																																									
Medium Cutting																																											

● = NEW

A

TURNING INSERTS

POSITION 11° WITH HOLE

C

D

R

S

T

V

W

TURNING INSERTS [POSITIVE]



WBGT 02 01 V3 L-F

Size Thickness Corner Radius R/L Chipbreaker
* Please refer to page A002.

CHIP CONTROL RANGE FOR WORK MATERIALS

Finish Cutting.....

Medium Cutting.....

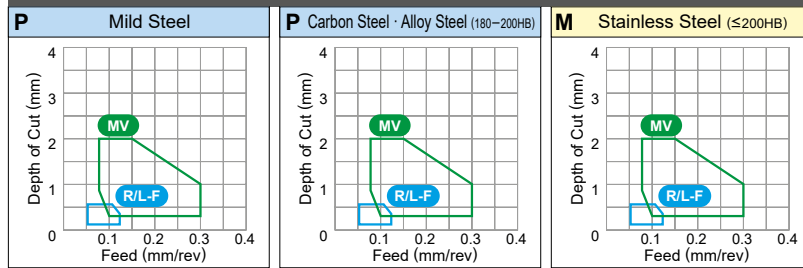

Cutting Conditions (Guide) : ● : Stable Cutting ● : General Cutting ☆ : Unstable Cutting

Work Material	P	Steel	●	●	●	☆	☆	☆	☆	Coated										Cermet	Coated Cermet	Carbide		Applicable Holder Page																																			
	M	Stainless Steel	●	●	●	☆	☆	☆	☆	UE6105	UE6110	MC6015	MC6025	UH6400	MS6015	MC7025	MP7035	US735	US905	MC5005	MC5015	MH515	MP9005		MP9015	MP9025	MS9025	VP05RT	VP10RT	VP15TF	UP20M	NX2525	NX3035	MP3025	AP25N	VP25N	VP45N	UT120T	HT110	RT9010	MT9005	MT9015																	
R/L-F	WBGT0201V3L-F	0.03																																																									
	WBGT020101L-F	0.1																																																									
	WBGT020102L-F	0.2																																																									
	WBGT020104L-F	0.4																																																									
	WBGTL302V3L-F	0.03																																																									
	WBGTL30201L-F	0.1																																																									
	WBGTL30202R-F	0.2																																																									
	WBGTL30202L-F	0.2																																																									
	WBGTL30204R-F	0.4																																																									
	WBGTL30204L-F	0.4																																																									
R/L-MV	WBMTL30202R-MV	0.2																																																									
	WBMTL30202L-MV	0.2																																																									
	WBMTL30204R-MV	0.4																																																									
	WBMTL30204L-MV	0.4																																																									

● = NEW

● : Inventory maintained. ★ : Inventory maintained in Japan.

CHIP CONTROL RANGE FOR WORK MATERIALS

Medium Cutting.....

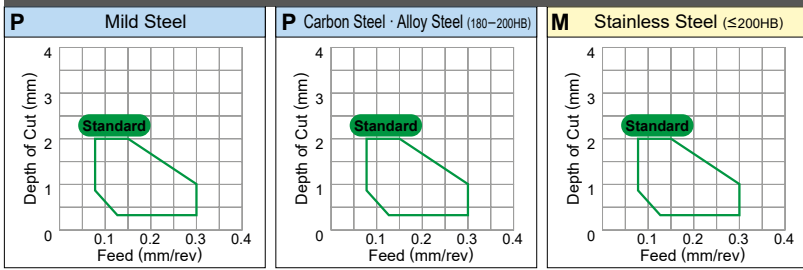

Cutting Conditions (Guide) : ● : Stable Cutting ● : General Cutting ✦ : Unstable Cutting

Work Material	P	Steel	● ● ● ● ✦ ●											Cermets		Coated Cermets		Carbides		Applicable Holder Page													
	M	Stainless Steel	● ● ● ● ✦ ●											Cermets		Coated Cermets		Carbides															
	K	Cast Iron	● ● ● ● ✦ ●											Cermets		Coated Cermets		Carbides															
	N	Non-ferrous Metal	● ● ● ● ✦ ●											Cermets		Coated Cermets		Carbides															
	S	Heat-resistant Alloy, Titanium Alloy	● ● ● ● ✦ ●											Cermets		Coated Cermets		Carbides															
Shape	Order Number	RE (mm)	Coated										Cermet	Coated Cermet		Carbide																	
			UE6105	UE6110	MC6015	MC6025	UH6400	MS6015	MC7025	MP7035	US735	US905	MC5005	MC5015	MH515	MP9005	MP9015		MP9025	MS9025	VP05RT	VP10RT	VP15TF	UP20M	NX2525	NX3035	MP3025	AP25N	VP25N	VP45N	UTI20T	HT110	RT9010
R/L	WCGT020102R	0.2																					●										
	WCGT020102L	0.2																						●									
	WCGT020104R	0.4																						●									
	WCGT020104L	0.4																						●									
	WCGTL30202L	0.2																						●									
Finish Cutting	WCGTL30204L	0.4																					●										
Standard	WCMT020102	0.2	★								●												● ●		● ●	★		●					
	WCMT020104	0.4	★								●												● ●		● ●	★		●					
	WCMTL30202	0.2	★								●												● ●		● ●	★		●					
	WCMTL30204	0.4	★								●												● ●		● ●	★		●					
	WCMT040202	0.2	★								●												● ●		● ●	★		●					
	WCMT040204	0.4	★								●												● ●		● ●	★		●					
	WCMT06T304	0.4	★								●												● ●		● ●	★		●					
Medium Cutting	WCMT06T308	0.8	★							●												● ●		● ●	★		●						

● = NEW

TURNING INSERTS

7° POSI

WITH HOLE

C

D

R

S

T

V

W



25° XC TYPE INSERTS WITH HOLE

XCMT 15 03 02- SVX
 Size Thickness Corner Radius Chipbreaker
 * Please refer to page A002.

CHIP CONTROL RANGE FOR WORK MATERIALS

Finish Cutting.....

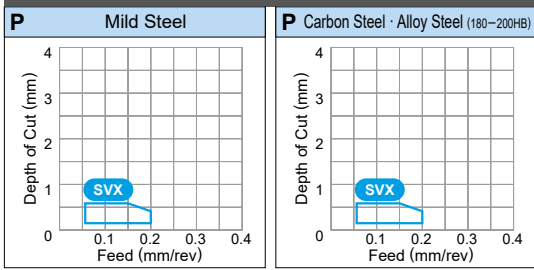

Cutting Conditions (Guide) : ●: Stable Cutting ●: General Cutting ✦: Unstable Cutting

Work Material	P	M	K	N	S	Cutting Conditions (Guide)																														
						UE6105	UE6110	MC6015	UH6400	MS6015	MC7025	MP7035	US735	US905	MC5005	MC5015	MH515	MP9005	MP9015	MP9025	MS9025	VP05RT	VP10RT	VP15TF	UP20M	NX2525	NX3035	MP3025	AP25N	VP25N	VP45N	UTI20T	HT110	RT9010	MT9005	MT9015
Shape	Order Number	RE (mm)	Coated										Cermet	Coated Cermet			Carbide				Applicable Holder Page															
			UE6105	UE6110	MC6015	UH6400	MS6015	MC7025	MP7035	US735	US905	MC5005	MC5015	MH515	MP9005	MP9015	MP9025	MS9025	VP05RT	VP10RT		VP15TF	UP20M	NX2525	NX3035	MP3025	AP25N	VP25N	VP45N	UTI20T	HT110	RT9010	MT9005	MT9015		
SVX	XCMT150302-SVX	0.2		●	●	●			●	●									●	●				●	●	●	●	●								
	XCMT150304-SVX	0.4		●	●	●			●	●									●	●				●	●	●	●	●								
	XCMT150308-SVX	0.8		●	●	●			●	●									●	●				●	●	●	●	●								
Finish Cutting																																				C032

● = NEW

TURNING INSERTS

A

7° POSI

WITH HOLE

C

D

R

S

T

V

W

CHIP CONTROL RANGE FOR WORK MATERIALS

Medium Cutting.....

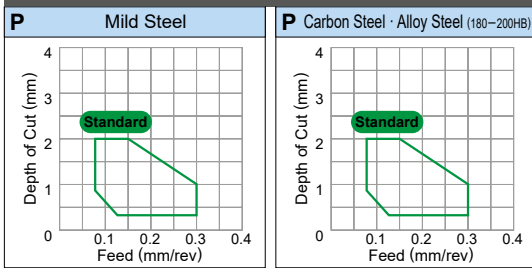

Cutting Conditions (Guide) : ● : Stable Cutting ● : General Cutting ✱ : Unstable Cutting

Work Material	P	Steel	● ● ● ✱ ● ●	Coated	Cermert	Coated Cermert	Carbide	Applicable Holder Page																														
	M	Stainless Steel	● ● ● ●																																			
	K	Cast Iron	● ● ● ● ●																																			
	N	Non-ferrous Metal	● ● ● ● ●																																			
	S	Heat-resistant Alloy, Titanium Alloy	● ● ● ● ●																																			
Shape	Order Number	RE (mm)	UE6105	UE6110	MC6015	MC6025	UH6400	MS6015	MC7025	MP7035	US735	US905	MC5005	MC5015	MH515	MP9005	MP9015	MP9025	MS9025	VP05RT	VP10RT	VP15TF	UP20M	NX2525	NX3035	MP3025	AP25N	VP25N	VP45N	UTI20T	HT110	RT9010	MT9005	MT9015				
			R	SPGR090304R	0.4																																	
80 Breaker	SPMR120308-80	0.8	●																																			
Standard	SPMR090304	0.4	✱																						✱ ✱ ●													
	SPMR090308	0.8	●																						● ● ✱													
	SPMR120304	0.4	●																						● ● ✱													
	SPMR120308	0.8	●																						● ✱ ✱													
Flat Top	SPMN090304	0.4																							✱						● ✱							
	SPMN090308	0.8	✱																						✱						● ●							
	SPMN120304	0.4	●																												● ●							
	SPMN120304T	0.4																							●						● ●							
	SPMN120308	0.8	●																												● ●							
	SPMN120312	1.2	●																												● ●							
	SPMN120408	0.8																													● ✱							
	SPMN120412	1.2																													✱							
	SPMN150408	0.8																													●							
	SPMN150412	1.2																													●							
	SPMN190404	0.4																													●							
	SPMN190408	0.8																													●							
	SPMN190412	1.2																													●							

● = NEW

A
TURNING INSERTS

POSI 11°
WITHOUT HOLE

C
D
R
S
T
V
W

TURNING INSERTS [POSITIVE]

90° SP TYPE INSERTS WITHOUT HOLE

SPGN 09 03 04

Size Thickness Corner Radius
 * Please refer to page A002.

CHIP CONTROL RANGE FOR WORK MATERIALS

Medium Cutting.....

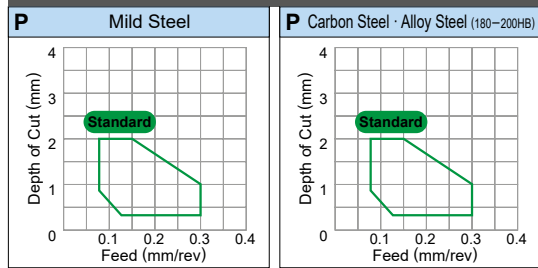

TURNING INSERTS

A

Cutting Conditions (Guide) : ● : Stable Cutting ● : General Cutting ✦ : Unstable Cutting

Work Material	P	Steel	●	●	●	✦	●																															
	M	Stainless Steel	●	●	●	✦	●	●	●	●	●	●	●	●	●	●	●	●	●																			
K	Cast Iron	●	●	●	✦	●	●	●	●	●	●	●	●	●	●	●	●	●	●																			
N	Non-ferrous Metal	●	●	●	✦	●	●	●	●	●	●	●	●	●	●	●	●	●	●																			
S	Heat-resistant Alloy, Titanium Alloy	●	●	●	✦	●	●	●	●	●	●	●	●	●	●	●	●	●	●																			
Shape	Order Number	RE (mm)	Coated										Cermet	Coated Cermet	Carbide	Applicable Holder Page																						
			UE6105	UE6110	MC6015	UH6400	MS6015	MC7025	MP7035	US735	US905	MC5005	MC5015	MH515	MP9005		MP9015	MP9025	MS9025	VP05RT	VP10RT	VP15TF	UP20M	NX2525	NX3035	MP3025	AP25N	VP25N	VP45N	UTI20T	HT110	RT9010	MT9005	MT9015				
	SPGN090304	0.4																					★															
	SPGN090308	0.8																																				
	SPGN120304	0.4																																				
	SPGN120308	0.8																																				
	SPGN120312	1.2																																				
	SPGN120404	0.4																																				
	SPGN120408	0.8																																				
	SPGN150404	0.4																																				
	SPGN150408	0.8																																				

● = NEW

● : Inventory maintained. ★ : Inventory maintained in Japan.

Cutting Conditions (Guide) : ● : Stable Cutting ● : General Cutting ✦ : Unstable Cutting

Work Material	P	Steel	Cutting Conditions (Guide)																																	
	M	Stainless Steel	●	●	●	✦	●																													
Work Material	K	Cast Iron								●	●	●																								
	N	Non-ferrous Metal																																		
	S	Heat-resistant Alloy, Titanium Alloy									●																									
Shape	Order Number	RE (mm)	Coated													Cermet	Coated Cermet	Carbide			Applicable Holder Page															
			UE6105	UE6110	MC6015	MC6025	UH6400	MS6015	MC7025	MP7035	US735	US905	MC5005	MC5015	MH515	MP9005	MP9015	MP9025	MS9025	VP05RT		VP10RT	VP15TF	UP20M	NX2525	NX3035	MP3025	AP25N	VP25N	VP45N	UTi20T	HTi10	RT9010	MT9005	MT9015	
Flat Top	TCGN060104	0.4																																		
	TCGN090204	0.4																																		

● = NEW

C
 D
 R
 S
 T
 V
 W

TURNING INSERTS [POSITIVE]



TPGR 11 03 04 R

Size Thickness Corner Radius R/L
* Please refer to page A002.

CHIP CONTROL RANGE FOR WORK MATERIALS

Finish Cutting.....

Medium Cutting.....

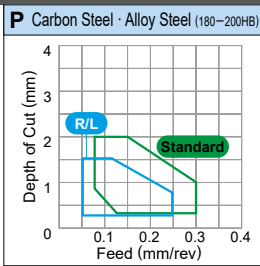
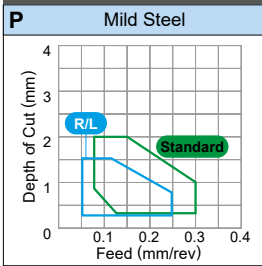

TURNING INSERTS

A

Cutting Conditions (Guide) : ● : Stable Cutting ● : General Cutting ✦ : Unstable Cutting

Work Material	P Steel M Stainless Steel K Cast Iron N Non-ferrous Metal S Heat-resistant Alloy, Titanium Alloy	Cutting Conditions (Guide)																	Applicable Holder Page																
		●	●	●	●	●	●	●	●	●	●	●	●	●	●	●	●	●																	
Shape	Order Number	RE (mm)	Coated										Cermet	Coated Cermet	Carbide																				
			UE6105	UE6110	MC6015	MC6025	UH6400	MS6015	MC7025	MP7035	US735	US905	MC5005	MC5015	MH515	MP9005		MP9015	MP9025	MS9025	VP05RT	VP10RT	VP15TF	UP20M	NX2525	NX3035	MP3025	AP25N	VP25N	VP45N	UTI20T	HT110	RT9010	MT9005	MT9015
R/L 	TPGR110304R	0.4																																	
	TPGR110304L	0.4																																	
	TPGR160304R	0.4																																	
	TPGR160304L	0.4																																	
	TPGR160308R	0.8																																	
Finish Cutting 	TPGR160308L	0.8																																	
	80 Breaker 	TPMR110304-80	0.4	●																															
		TPMR110308-80	0.8	●																															
		TPMR160304-80	0.4	●																															
Light - Medium Cutting 	TPMR160308-80	0.8	●																																
	Standard 	TPMR090202	0.2																						★	★									
		TPMR090204	0.4																						●	★	●								
		TPMR090208	0.8																							★									
TPMR110302		0.2																						●	★	★									
TPMR110304		0.4	●																					●	●	●									
Medium Cutting 	TPMR110308	0.8	●																				●	●	●										
	TPMR160304	0.4	●																				●	●	●										
	TPMR160308	0.8	●																				●	★	●										
	TPMR160312	1.2	●																					★	●										
	Flat Top 	TPMN110208	0.8																																
		TPMN110304	0.4	●								★	●											●	●					●	●				
		TPMN110308	0.8	★								●	●												★				●	●					
TPMN160304		0.4	●								●	●											★	★	●				●	●					
TPMN160308		0.8	●								●	●											★	●	●				●	●					
TPMN160312		1.2	★								★	●											●						★						
TPMN160320		2.0																										●							
TPMN220404		0.4	★																										●						
TPMN220408		0.8	★																				★	●					●	●					
TPMN220408T	0.8																							●											
TPMN220412	1.2	★																				★						●	●						

● = NEW

● : Inventory maintained. ★ : Inventory maintained in Japan.

Cutting Conditions (Guide) : ● : Stable Cutting ● : General Cutting ✖ : Unstable Cutting

Work Material	P	Steel	●	●	●	✖	●																														
	M	Stainless Steel					●	●	●																												
	K	Cast Iron								●	●	●																									
Shape	Order Number	RE (mm)	Coated										Cermets	Coated Cermets				Carbides				Applicable Holder Page															
			UE6105	UE6110	MC6015	MC6025	UH6400	MS6015	MC7025	MP7035	US735	US905		MC5005	MC5015	MH515 <small>NEW</small>	MP9005	MP9015	MP9025 <small>NEW</small>	MS9025	VP05RT		VP10RT	VP15TF	UP20M	NX2525	NX3035	MP3025	AP25N	VP25N	VP45N	UTi20T	HTi10	RT9010	MT9005	MT9015	
 Flat Top	TPGN110302	0.2																																			
	TPGN110304	0.4																					★							★	●						
	TPGN110308	0.8																					★							★	●						
	TPGN160302	0.2																													★						
	TPGN160304	0.4																					★	★					★	●							
	TPGN160308	0.8																					★	★					★	●							
	TPGN160312	1.2																												★							
	TPGN160316	1.6																												★							
	TPGN160408	0.8																											★								
	TPGN220404	0.4																														★					
TPGN220408	0.8																														★						

● = NEW



TURNING INSERTS

POSI 11°

WITHOUT HOLE

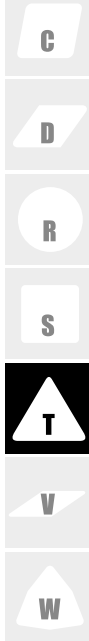

CHIPBREAKERS > A072
 GRADES > A030
 IDENTIFICATION > A002

Memo

A series of horizontal dashed lines for writing, spanning the width of the page.

Memo

A series of horizontal dashed lines for writing, spanning the width of the page.

HOW TO READ THE STANDARD OF PCBN&PCD TURNING INSERTS

● How this section page is organised

- ① Organised according to turning insert shape.
(Refer to the index on the next page.)
- ② Inserts are arranged in order of :
 - Negative inserts (with hole→without hole)
 - Positive inserts (with hole→without hole)

GRADE APPLICATION RECOMMENDED FOR EACH WORK MATERIAL

Cutting conditions suitable for each type of work material is shown as a general guide to select the grade.

● : Stable Cutting ● : General Cutting ✦ : Unstable Cutting

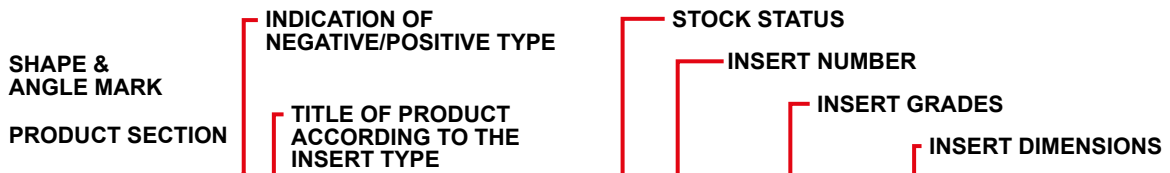

PCBN TURNING INSERTS [NEGATIVE]

80° CN TYPE INSERTS WITH HOLE

Work Material	Coated PCBN	PCBN	Dimensions (mm)	Geometry	Applicable Holder Page
IC	S	RE	D1		
NP-CNGA120404GS4	●●●●●	●●●●●	12.74.76 0.4 1.8 5.16		
NP-CNGA120408GS4	●●●●●	●●●●●	12.74.76 0.8 2.0 5.16		
NP-CNGA120412GS4	●●●●●	●●●●●	12.74.76 1.2 2.2 5.16		
NP-CNGA120404GA4	●●●●●	●●●●●	12.74.76 0.4 1.8 5.16		
NP-CNGA120408GA4	●●●●●	●●●●●	12.74.76 0.8 2.0 5.16		
NP-CNGA120412GA4	●●●●●	●●●●●	12.74.76 1.2 2.2 5.16		
NP-CNGA120404GH4	●●●●●	●●●●●	12.74.76 0.4 1.8 5.16		
NP-CNGA120408GH4	●●●●●	●●●●●	12.74.76 0.8 2.0 5.16		
NP-CNGA120412GH4	●●●●●	●●●●●	12.74.76 1.2 2.2 5.16		
NP-CNGA120404VA4	●●●●●	●●●●●	12.74.76 0.4 1.8 5.16		
NP-CNGA120408VA4	●●●●●	●●●●●	12.74.76 0.8 2.0 5.16		
NP-CNGA120412VA4	●●●●●	●●●●●	12.74.76 1.2 2.2 5.16		
NP-CNGA120404FS4	●●●●●	●●●●●	12.74.76 0.4 1.8 5.16		
NP-CNGA120408FS4	●●●●●	●●●●●	12.74.76 0.8 2.0 5.16		
NP-CNGA120412FS4	●●●●●	●●●●●	12.74.76 1.2 2.2 5.16		
NP-CNGA120404TS4	●●●●●	●●●●●	12.74.76 0.4 1.8 5.16		
NP-CNGA120408TS4	●●●●●	●●●●●	12.74.76 0.8 2.0 5.16		
NP-CNGA120412TS4	●●●●●	●●●●●	12.74.76 1.2 2.2 5.16		
NP-CNGA120404TA4	●●●●●	●●●●●	12.74.76 0.4 1.8 5.16		
NP-CNGA120408TA4	●●●●●	●●●●●	12.74.76 0.8 2.0 5.16		
NP-CNGA120412TA4	●●●●●	●●●●●	12.74.76 1.2 2.2 5.16		
NP-CNGA120404TH4	●●●●●	●●●●●	12.74.76 0.4 1.8 5.16		
NP-CNGA120408TH4	●●●●●	●●●●●	12.74.76 0.8 2.0 5.16		
NP-CNGA120412TH4	●●●●●	●●●●●	12.74.76 1.2 2.2 5.16		
NP-CNGA120404SW4	●●●●●	●●●●●	12.74.76 0.4 1.8 5.16		
NP-CNGA120408SW4	●●●●●	●●●●●	12.74.76 0.8 2.0 5.16		
NP-CNGA120412SW4	●●●●●	●●●●●	12.74.76 1.2 2.2 5.16		

PCBN TURNING INSERTS [POSITIVE]

Work Material	Coated PCBN	PCBN	Dimensions (mm)	Geometry	Applicable Holder Page
IC	S	RE	D1		
NP-CNGA120402GS2	●●●●●	●●●●●	12.74.76 0.2 1.7 5.16		
NP-CNGA120404GS2	●●●●●	●●●●●	12.74.76 0.4 1.8 5.16		
NP-CNGA120408GS2	●●●●●	●●●●●	12.74.76 0.8 2.0 5.16		
NP-CNGA120412GS2	●●●●●	●●●●●	12.74.76 1.2 2.2 5.16		
NP-CNGA120402GA2	●●●●●	●●●●●	12.74.76 0.2 1.7 5.16		
NP-CNGA120404GA2	●●●●●	●●●●●	12.74.76 0.4 1.8 5.16		
NP-CNGA120408GA2	●●●●●	●●●●●	12.74.76 0.8 2.0 5.16		
NP-CNGA120412GA2	●●●●●	●●●●●	12.74.76 1.2 2.2 5.16		
NP-CNGA120402GH2	●●●●●	●●●●●	12.74.76 0.2 1.7 5.16		
NP-CNGA120404GH2	●●●●●	●●●●●	12.74.76 0.4 1.8 5.16		
NP-CNGA120408GH2	●●●●●	●●●●●	12.74.76 0.8 2.0 5.16		
NP-CNGA120412GH2	●●●●●	●●●●●	12.74.76 1.2 2.2 5.16		
NP-CNGA120402VA2	●●●●●	●●●●●	12.74.76 0.2 1.7 5.16		
NP-CNGA120404VA2	●●●●●	●●●●●	12.74.76 0.4 1.8 5.16		
NP-CNGA120408VA2	●●●●●	●●●●●	12.74.76 0.8 2.0 5.16		
NP-CNGA120412VA2	●●●●●	●●●●●	12.74.76 1.2 2.2 5.16		
NP-CNGA120402FS2	●●●●●	●●●●●	12.74.76 0.2 1.7 5.16		
NP-CNGA120404FS2	●●●●●	●●●●●	12.74.76 0.4 1.8 5.16		
NP-CNGA120408FS2	●●●●●	●●●●●	12.74.76 0.8 2.0 5.16		
NP-CNGA120412FS2	●●●●●	●●●●●	12.74.76 1.2 2.2 5.16		
NP-CNGA120402TS2	●●●●●	●●●●●	12.74.76 0.2 1.7 5.16		
NP-CNGA120404TS2	●●●●●	●●●●●	12.74.76 0.4 1.8 5.16		
NP-CNGA120408TS2	●●●●●	●●●●●	12.74.76 0.8 2.0 5.16		
NP-CNGA120412TS2	●●●●●	●●●●●	12.74.76 1.2 2.2 5.16		
NP-CNGA120402TA2	●●●●●	●●●●●	12.74.76 0.2 1.7 5.16		
NP-CNGA120404TA2	●●●●●	●●●●●	12.74.76 0.4 1.8 5.16		
NP-CNGA120408TA2	●●●●●	●●●●●	12.74.76 0.8 2.0 5.16		
NP-CNGA120412TA2	●●●●●	●●●●●	12.74.76 1.2 2.2 5.16		
NP-CNGA120402TH2	●●●●●	●●●●●	12.74.76 0.2 1.7 5.16		
NP-CNGA120404TH2	●●●●●	●●●●●	12.74.76 0.4 1.8 5.16		
NP-CNGA120408TH2	●●●●●	●●●●●	12.74.76 0.8 2.0 5.16		
NP-CNGA120412TH2	●●●●●	●●●●●	12.74.76 1.2 2.2 5.16		
NP-CNGA120402SW2	●●●●●	●●●●●	12.74.76 0.2 1.7 5.16		
NP-CNGA120404SW2	●●●●●	●●●●●	12.74.76 0.4 1.8 5.16		
NP-CNGA120408SW2	●●●●●	●●●●●	12.74.76 0.8 2.0 5.16		
NP-CNGA120412SW2	●●●●●	●●●●●	12.74.76 1.2 2.2 5.16		

● : Inventory maintained. * : Inventory maintained in Japan.

GRADES → B004 IDENTIFICATION → B002

LEGEND FOR STOCK STATUS MARK
Is shown on the left hand page of each double-page spread.

PHOTO OF INSERT

PRODUCT NAME

PAGE REFERENCE
· CHIPBREAKERS
· GRADES
· TECHNICAL DATA
Indicates reference pages, on the right hand page of each double-page spread.

APPLICABLE HOLDER PAGE
Indicates reference pages for details of applicable holders.

FIGURE SHOWING THE INSERT GEOMETRY
IC: Diameter of Inscribed Circle
S: Thickness
RE: Corner Radius
D1: Diameter of Hole
LE: Cutting Edge Effective Length
Dimensions are detailed in the "Dimensions" column.

TURNING TOOLS

PCBN & PCD INSERT STANDARDS

PCBN & PCD INSERT GRADES

IDENTIFICATION	B002
CLASSIFICATION OF PCBN & PCD GRADES ..	B004
CBN (CUBIC BORON NITRIDE)	B006
PCD (SINTERED DIAMOND)	B028
CLASSIFICATION OF PCBN & PCD INSERTS	B030

STANDARD OF PCBN TURNING INSERTS

NEGATIVE INSERTS WITH HOLE

CN TYPE ... RHOMBIC 80°	B036
DN TYPE ... RHOMBIC 55°	B039
SN TYPE ... SQUARE 90°	B043
TN TYPE ... TRIANGULAR 60° ...	B044
VN TYPE ... RHOMBIC 35°	B046
WN TYPE ... TRIGON 80°	B048

NEGATIVE INSERTS WITHOUT HOLE

CN TYPE ... RHOMBIC 80°	B049
DN TYPE ... RHOMBIC 55°	B049
RN TYPE ... ROUND	B049
SN TYPE ... SQUARE 90°	B050
TN TYPE ... TRIANGULAR 60° ...	B050

POSITIVE INSERTS WITH HOLE

CC TYPE ... RHOMBIC 80°	B051
CP TYPE ... RHOMBIC 80°	B053
DC TYPE ... RHOMBIC 55°	B054
TC TYPE ... TRIANGULAR 60° ...	B056
TP TYPE ... TRIANGULAR 60° ...	B057
VB TYPE ... RHOMBIC 35°	B059
VC TYPE ... RHOMBIC 35°	B060
WC TYPE ... TRIGON 80°	B060

POSITIVE INSERTS WITHOUT HOLE

SP TYPE ... SQUARE 90°	B061
TB TYPE ... TRIANGULAR 60° ...	B062
TP TYPE ... TRIANGULAR 60° ...	B062
GY TYPE	B063

STANDARD OF PCD TURNING INSERTS

NEGATIVE INSERTS WITH HOLE

CN TYPE ... RHOMBIC 80°	B064
DN TYPE ... RHOMBIC 55°	B064
SN TYPE ... SQUARE 90°	B065
TN TYPE ... TRIANGULAR 60° ...	B065
VN TYPE ... RHOMBIC 35°	B066

POSITIVE INSERTS WITH HOLE

CC TYPE ... RHOMBIC 80°	B067
CP TYPE ... RHOMBIC 80°	B067
DC TYPE ... RHOMBIC 55°	B068
SP TYPE ... SQUARE 90°	B068
TC TYPE ... TRIANGULAR 60° ...	B069
TP TYPE ... TRIANGULAR 60° ...	B070
VB TYPE ... RHOMBIC 35°	B071
VC TYPE ... RHOMBIC 35°	B071
WC TYPE ... TRIGON 80°	B072
WP TYPE ... TRIGON 80°	B072
DE TYPE ... RHOMBIC 55°	B073
TE TYPE ... TRIANGULAR 60° ...	B073
VD TYPE ... RHOMBIC 35°	B074

POSITIVE INSERTS WITHOUT HOLE

SP TYPE ... SQUARE 90°	B075
TP TYPE ... TRIANGULAR 60° ...	B075

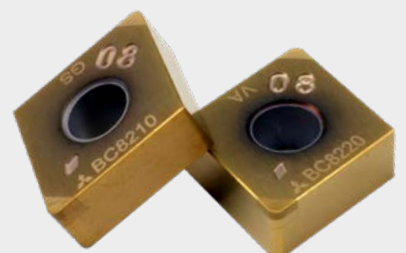

IDENTIFICATION

B

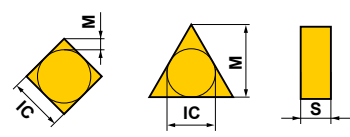

Symbol	Tolerance of Nose Height M (mm)	Tolerance of Inscribed Circle IC (mm)	Tolerance of Thickness S (mm)
G	±0.025	±0.025	±0.13
M*	±0.08–±0.18	±0.05–±0.15	±0.13

Inserts marked with * are sintered.

Detail of M Class Insert Tolerance

● Tolerance of Nose Height **M** (mm)

D.I.C.	Triangular	Square	Rhombic 80°	Rhombic 55°	Rhombic 35°	Round
6.35	±0.08	±0.08	±0.08	±0.11	±0.16	—
9.525	±0.08	±0.08	±0.08	±0.11	±0.16	—
12.70	±0.13	±0.13	±0.13	±0.15	—	—

● Tolerance of Inscribed Circle **IC** (mm)







D.I.C.	Triangular	Square	Rhombic 80°	Rhombic 55°	Rhombic 35°	Round
6.35	±0.05	±0.05	±0.05	±0.05	±0.05	—
9.525	±0.05	±0.05	±0.05	±0.05	±0.05	±0.05
12.70	±0.08	±0.08	±0.08	±0.08	—	±0.08

BM	With Breaker
BF	With Breaker
NP	New Petit Cut
No mark	Standard Type







① Insert Geometry

NP - **D** **N** **G** **A**







② Insert Shape

Symbol	Insert Shape
C	Rhombic 80° 
D	Rhombic 55° 
R	Round 
S	Square 
T	Triangular 
V	Rhombic 35° 
W	Trigon 

③ Normal Clearance

Symbol	Normal Clearance
B	5° 
C	7° 
D	15° 
E	20° 
N	0° 
P	11° 

⑤ Fixing and/or for Chipbreaker

Metric				
Symbol	Hole	Hole Configuration	Chip Breaker	Figure
W	With Hole	Cylindrical Hole +	No	
T/V	With Hole	One Countersink (40–60°)	One Sided	
B	With Hole	Cylindrical Hole +	No	
H	With Hole	One Countersink (70–90°)	One Sided	
A	With Hole	Cylindrical Hole	No	
M	With Hole	Cylindrical Hole	One Sided	
N	Without Hole	—	No	
X	—	—	—	Special Design

Diameter of Inscribed Circle (mm)	Symbol						
3.97		02		04	03	03	06
4.76		L3	08	05	04	04	08
5.56		03	09	06	05	05	09
6.35		04	11	07	06	06	11
7.94		05	13	09	08	07	13
9.525	09	06	16	11	09	09	16
12.70	12	08	22	15	12	12	22

⑥ Insert Size

*Thickness is from the bottom of the insert to the top of the cutting edge.

Symbol	Thickness (mm)
S1	1.39
01	1.59
T0	1.79
02	2.38
T2	2.78
03	3.18
T3	3.97
04	4.76

⑦ Insert Thickness

Symbol	Corner Radius (mm)
02	0.2
04	0.4
08	0.8
12	1.2
16	1.6

⑧ Insert Corner Configuration

⑥ 15 **⑦ 04** **⑧ 04** **⑨ GA** **⑩ W** **⑪ 2** **⑫ J** **⑬ R**

⑨ Application (Honing)

Symbol	Honing
GS GA GB GH	General Cutting
VA	For High Speed, High Feed Cutting
FS FA FB	Continuous Cutting
TS TA TH	Interrupted Cutting
SF SE	Sintered Alloys Cutting

⑩ Wiper

WS	For High Rigidity Workpiece Material
WL	For Deflection and Vibration Prevention
No mark	Without Wiper

⑪ Number of Teeth

2	2
3	3
4	4
6	6
No mark	1

⑫ Cutting Edge Angle

F	91°
J	93°
No mark	Non Restriction

Please pay special attention when using wiper inserts.

⑬ Cutting Direction

Figure	Hand	Symbol
	Right	R
	Left	L
	Neutral	N

Please refer to page B021 for further information.

CLASSIFICATION OF PCBN & PCD GRADES

FEATURES

NON-COATED PCBN MATERIALS

PCBN sintered material base cutting tools are produced by binding CBN (cubic Boron Nitride) and ceramic having hardness next to diamond and sintering them under ultra-high pressure and at high temperature.

PCBN has lower affinity to iron than diamond. The low affinity and high hardness properties means that sintered PCBN delivers a superior cutting performance especially during high speed machining of materials such hardened steel, cast iron and sintered alloys.

B

COATED PCBN MATERIALS

To achieve longer tool life, MITSUBISHI MATERIALS uses a unique "Particle-activated Sintering Method", combined with increased cutting edge strength. With high crater wear resistance PCBN grades, plus a wear resistant ceramic coating, longer tool life and improved machine efficiency are obtained.

PCD MATERIALS (Sintered Diamond)

Suitable for cutting materials such as nonferrous metals and fibre reinforced plastics (FRP) including aluminium alloys. It supports ultra high speed finish machining.

■ Work materials for turning grades/application area

● Hardened Steel

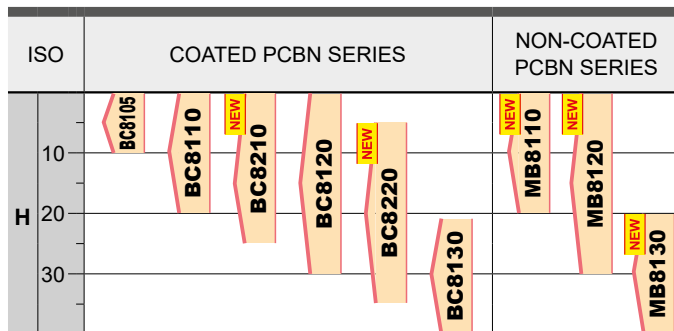

COATED PCBN MATERIALS

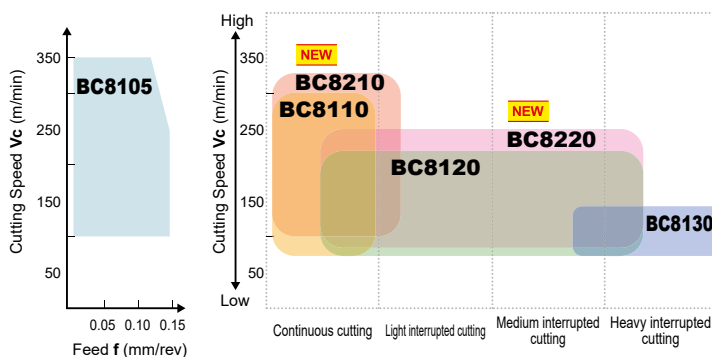

NON-COATED PCBN MATERIALS

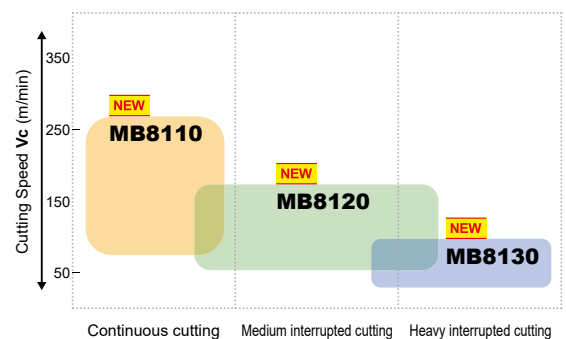

Suitable for finishing with surface roughness R_a 0.6 μm or R_z 2.4 μm or less.

Coated PCBN Grade BC8100/BC8200 and non-coated PCBN Grade MB8100 for high-hardness steel processing are available in a wide range of areas from finishing to continuous cutting of hardened steels and strongly interrupted machining.

● Sintered Alloy

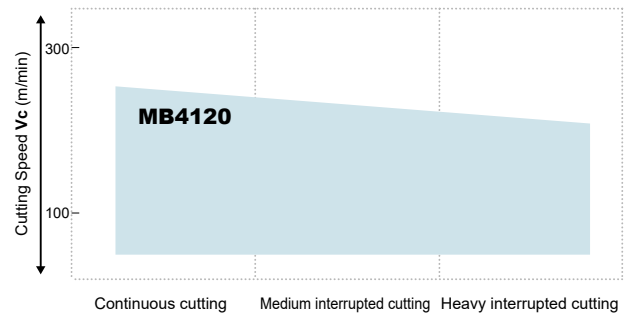
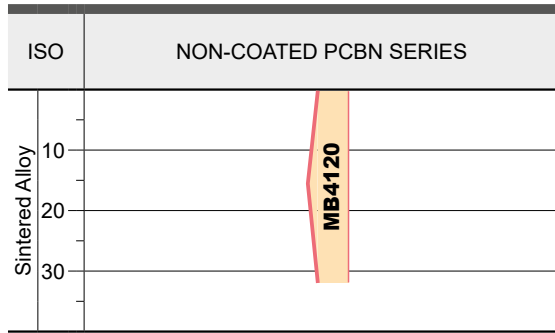

The PCBN grade "MB4120" for cutting sintered alloys and cast iron can be used over a wide range of applications from continuous to interrupted machining of cast iron and sintered alloy components such as oil pumps and valve mechanisms.

● Cast Iron

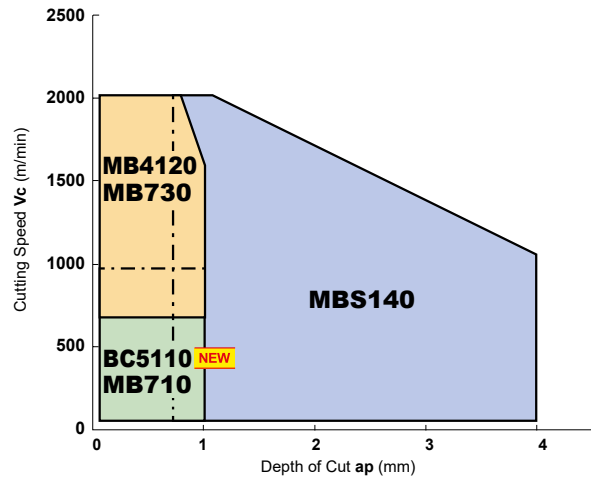
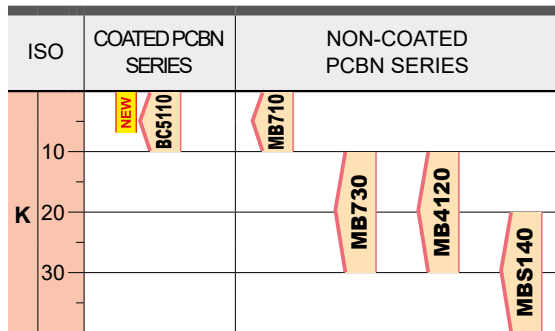

BC5110

Tough substrate with a high hardness coating provides excellent chipping and wear resistance.

Range of grades available for general to higher depths of cut to enable high efficiency machining.

● Aluminium Alloy

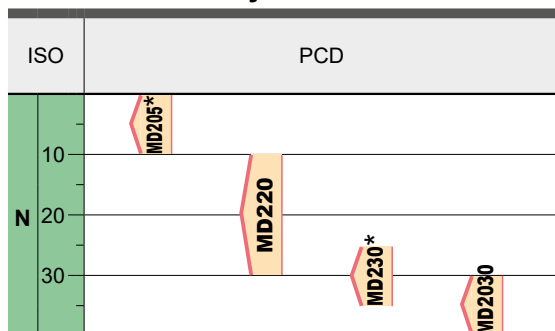

* MD205, MD230 : Non-Standard

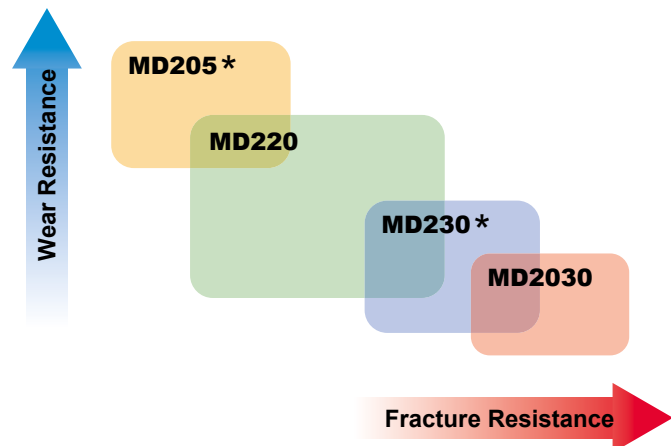

Suitable for cutting materials such as nonferrous metals and fiber reinforced plastics (FRP) including aluminium alloys. It supports ultra high speed finish cutting.

COATED PCBN SERIES

BC8200 series for machining of hardened steel

FEATURES

■ A Newly Developed Special Ceramic PVD Coating

BC8210

NEW

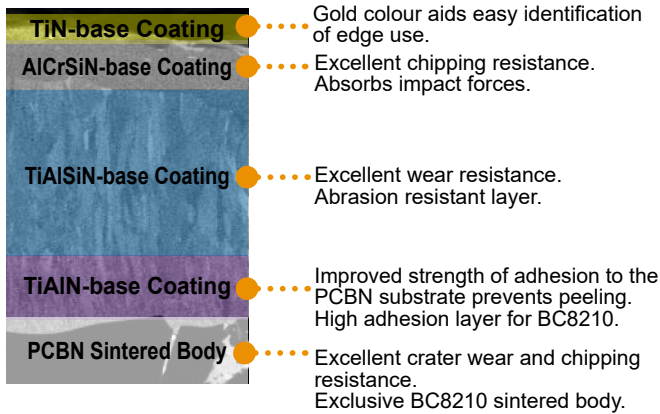

BC8220

NEW

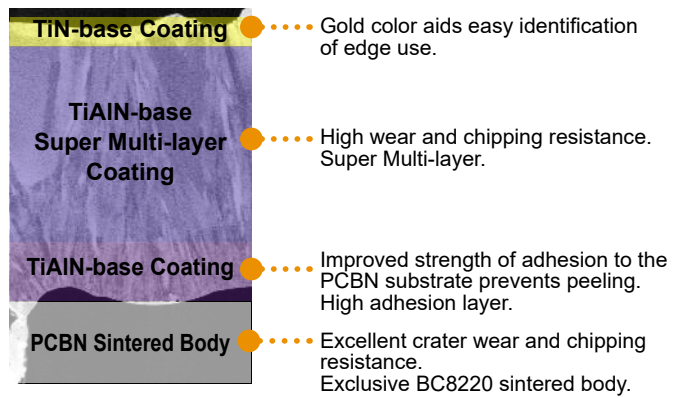

■ Ultra Micro-Particle and Heat Resistant Binder Technology

Positive Effect of the Newly Developed Heat Resistant Binder

The progress of crater wear is greatly reduced due to the use of a heat resistant binder. This suppresses chipping, crater wear and fracturing.

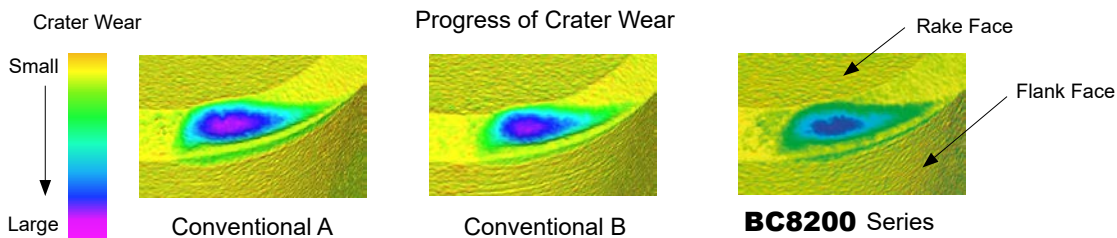
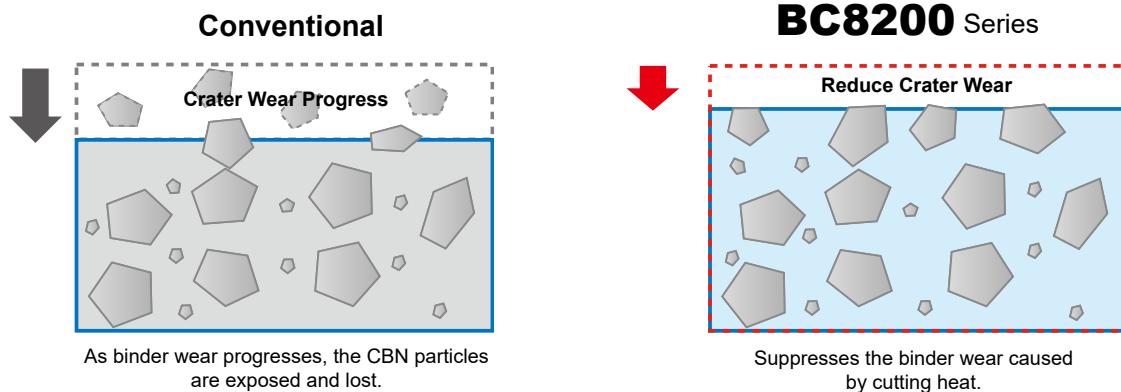

Application range

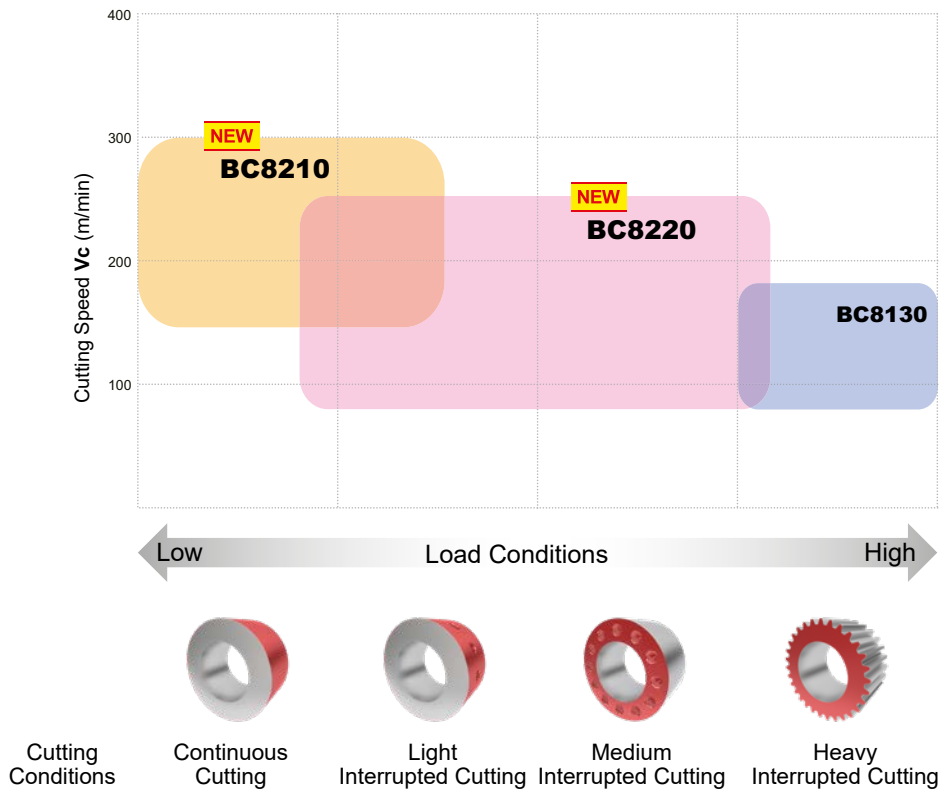

B

Recommended Cutting Conditions

BC8210

Workpiece Material	Machining Methods	Cutting Speed V_c (m/min)					Feed per Rev. f (mm/rev)	Depth of Cut a_p (mm)	Cutting Mode
		100	150	200	250	300			
Hardened Steels	Continuous Cutting	[Red bar from 150 to 250]					≤ 0.2	≤ 0.35	Dry, Wet
	Light Interrupted Cutting	[Red bar from 100 to 200]					≤ 0.2	≤ 0.35	Dry, Wet

BC8220

Workpiece Material	Machining Methods	Cutting Speed V_c (m/min)					Feed per Rev. f (mm/rev)	Depth of Cut a_p (mm)	Cutting Mode
		100	150	200	250	300			
Hardened Steels	Continuous Cutting	[Red bar from 150 to 200]					≤ 0.2	≤ 0.5	Dry, Wet
	Light to Medium Interrupted Cutting	[Red bar from 100 to 150]					≤ 0.2	≤ 0.3	Dry, Wet

COATED PCBN SERIES

BC8200 series for machining of hardened steel

■ Cutting and application example

BC8210 For Continuous and Light Interrupted Cutting

Machining Scr420 (60 HRC): Comparison of Continuous Cutting

BC8210 reduces flank wear and maintains a good finished surface.

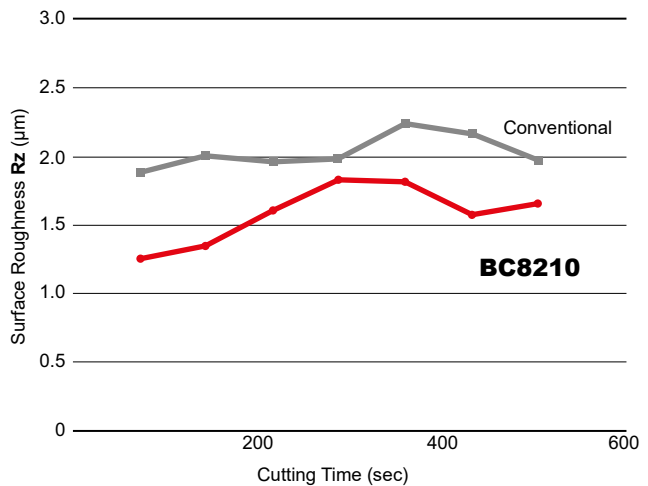
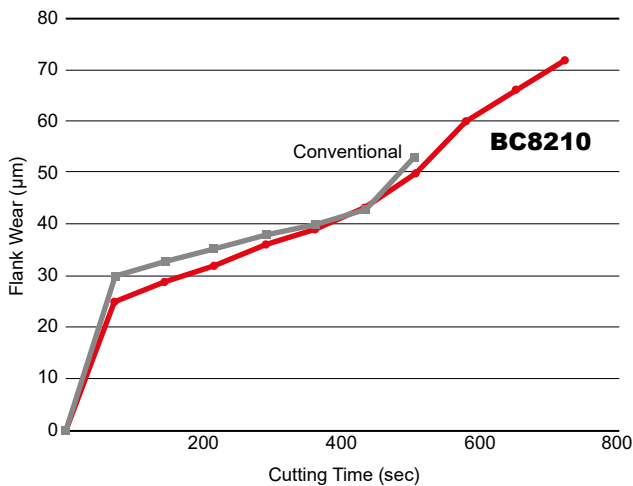

<Cutting Conditions>

Workpiece Material : JIS SCr420 (60 HRC)
 Inserts : NP-CNGA120408GS2
 Cutting Speed : Vc=200 m/min
 Feed per Rev. : f=0.1 mm/rev
 Depth of Cut : ap=0.2 mm
 Cutting Mode : Dry Cutting

Machining Scr420(60 HRC):Comparison of Light Interrupted Cutting

BC8210 provides excellent chipping resistance.

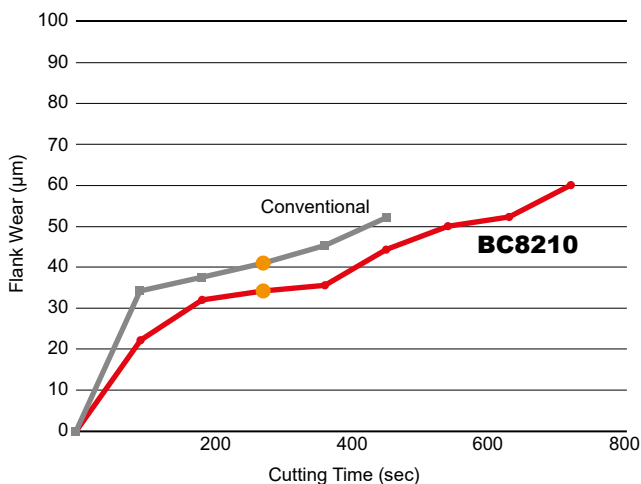

After machining 360 seconds

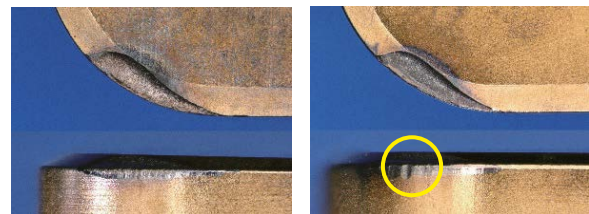

BC8210

Conventional Product is Chipping

<Cutting Conditions>

Workpiece Material : JIS SCr420 (60 HRC)
 Inserts : NP-CNGA120408GS2
 Cutting Speed : Vc=160 m/min
 Feed per Rev. : f=0.1 mm/rev
 Depth of Cut : ap=0.2 mm
 Cutting Mode : Dry Cutting

BC8220 General Applications

Machining SCr420 (60HRC): Comparison of Fracture Resistance During Medium Interrupted Cutting

Stable cutting is achieved with excellent fracture resistance during medium interrupted cutting.

B

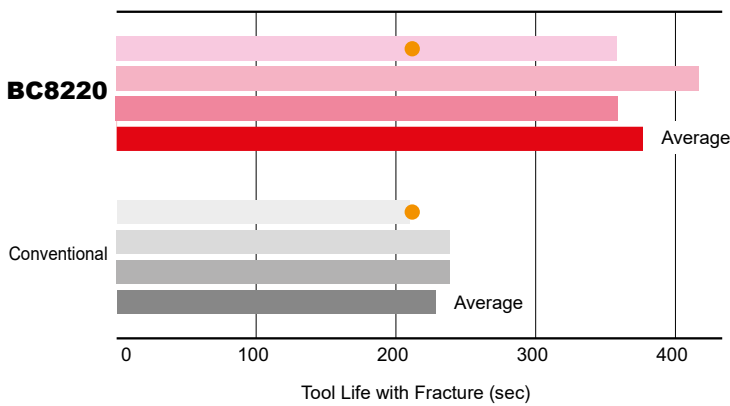

After machining 210 seconds

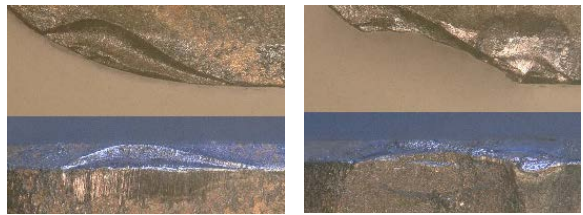

BC8220

Conventional

<Cutting Conditions>

Workpiece Material : JIS SCr420 (60 HRC)
 Inserts : NP-CNGA120408VA2
 Cutting Speed : Vc=250 m/min
 Feed per Rev. : f=0.15 mm/rev
 Depth of Cut : ap=0.1 mm
 Cutting Mode : Dry Cutting

Machining SCr420(60HRC): Comparison of Fracture Resistance During Heavy Interrupted Cutting

Achieves excellent chipping resistance during heavy interrupted cutting.

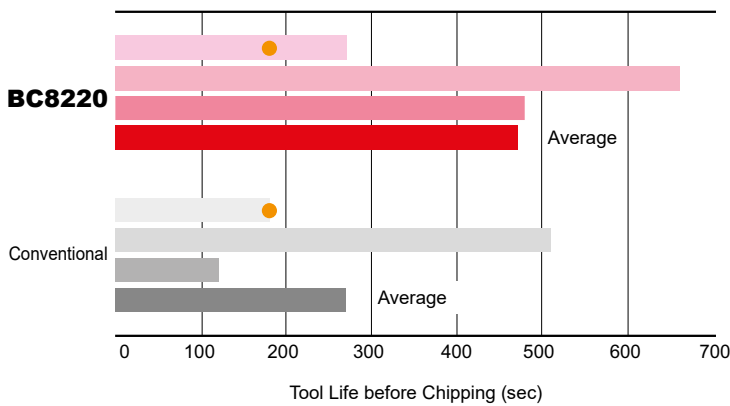

After machining 180 seconds



BC8220

Conventional Product is Chipping

<Cutting Conditions>

Workpiece Material : JIS SCr420 (60 HRC)
 Inserts : NP-CNGA120408VA2
 Cutting Speed : Vc=200 m/min
 Feed per Rev. : f=0.05 mm/rev
 Depth of Cut : ap=0.1 mm
 Cutting Mode : Wet Cutting

COATED PCBN SERIES

BC8100 series for machining of hardened steel

FEATURES

The coated PCBN grade BC8100 series and non-coated PCBN grade MB8100 series for cutting of hardened steel uses a newly developed optimized substrate technology for the PCBN base material. The new ultra-micro-binder prevents sudden fracturing and gives longer tool life. The BC8100 series coating exhibits excellent fracture resistance and wear resistance by using a special PVD coating suitable for each cutting mode.

B

■ With a Newly Developed Special Ceramic PVD Coating

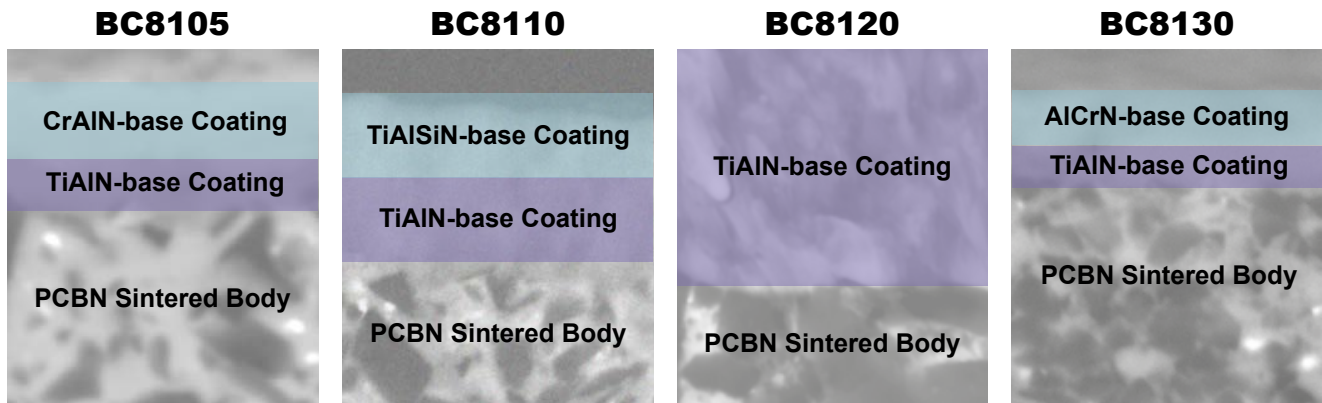

Offers excellent surface finishes. Peeling resistance and adhesion strength are improved by having both high lubricity and wear resistance.

Chipping caused by built up edge is prevented with improved welding resistance. Improved wear and adhesion strength to the PCBN surface.

Chipping caused by a built up edge is prevented with improved welding resistance. Improved adhesion to the coating to the CBN surface enhances peeling resistance. The PCBN also has improved toughness by adopting new binder and sintering method.

Peeling caused by severe impact and chipping are prevented with high fracture resistance. Improved adhesion strength to the PCBN surface.

*Graphical representation.

■ Ultra Micro-Particle Binder Prevents Sudden Fractures

● Conventional

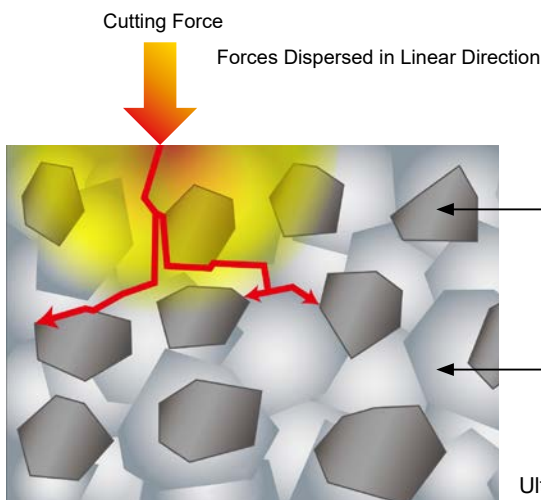

● BC8100 Series BC8200 Series

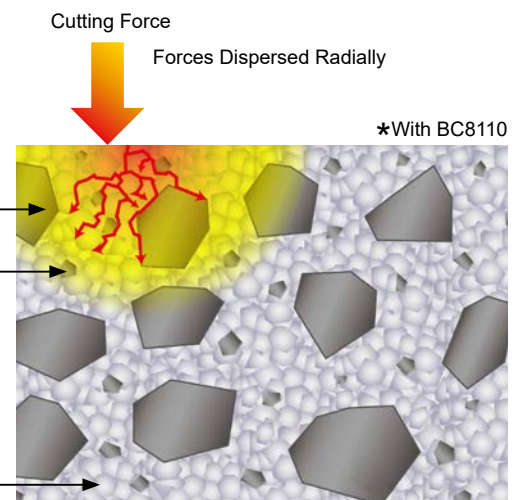

The ultra micro-particle binder prevents linear crack development to avoid sudden fracturing.

Application range

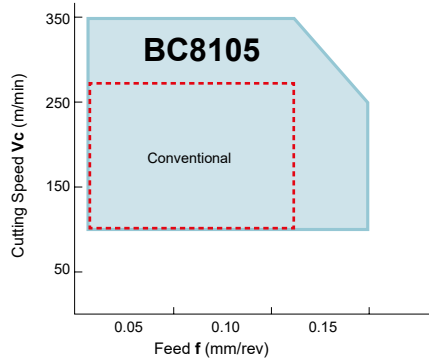

*BC8110 is recommended to improve wear resistance.

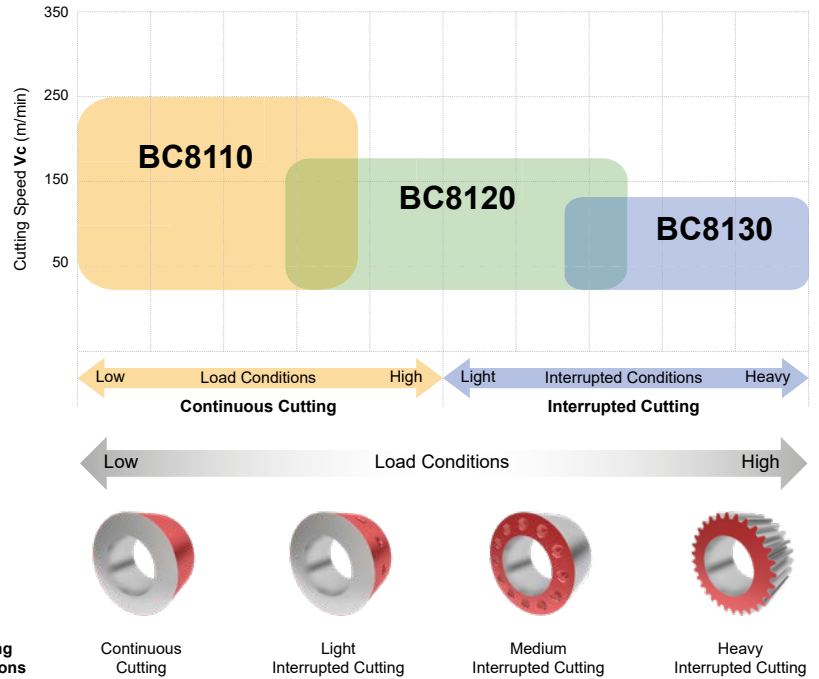

B

Recommended cutting conditions

Grade	Cutting mode	Cutting Speed V_c (m/min)				Feed f (mm/rev)	Depth of Cut a_p (mm)	Cutting Mode	
		50	150	250	350				
BC8100 Series	BC8105	Continuous	[Red bar from ~120 to ~280]				≤ 0.15	≤ 0.2	Dry, Wet
	BC8110	Continuous	[Red bar from ~120 to ~250]				≤ 0.20	≤ 0.35	Dry, Wet
	BC8120	Continuous	[Red bar from ~120 to ~220]				≤ 0.3	≤ 0.5	Dry, Wet
	BC8120	Interrupted	[Red bar from ~100 to ~200]				≤ 0.2	≤ 0.3	Dry, Wet
	BC8130	Interrupted	[Red bar from ~80 to ~150]				≤ 0.20	≤ 0.30	Dry, Wet

COATED PCBN SERIES

BC8100 Series

■ Cutting example and application example

BC8105 Highest Accuracy

B

Use of a PCBN substrate with excellent wear resistance and chipping resistance, together with a high-lubricity coating film, controls the occurrence of boundary wear and exhibits outstanding surface roughness.

Suitable for finishing with surface roughness Ra 0.6 μm or Rz 2.4 μm or less.

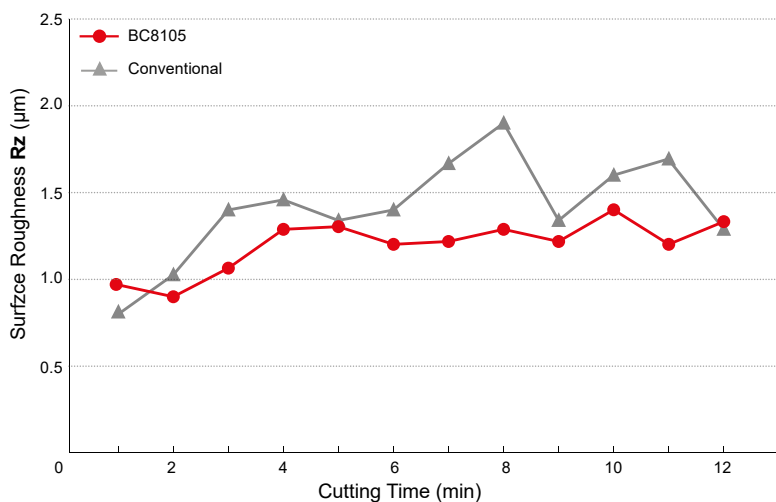

Insert	NP-CNGA120408GS2
Work Material	JIS SCr420 (60HRC)
Machining Methods	External Continuous Cutting
Cutting Speed Vc (m/min)	200
Feed f (mm/rev)	0.05
Depth of Cut ap (mm)	0.05
Cutting Mode	Dry Cutting

BC8110 High Speed Turning

Use of a CBN substrate with excellent wear resistance and chipping resistance, together with an extremely hard coating film, provides the highest flank wear resistance of the entire BC81 series.

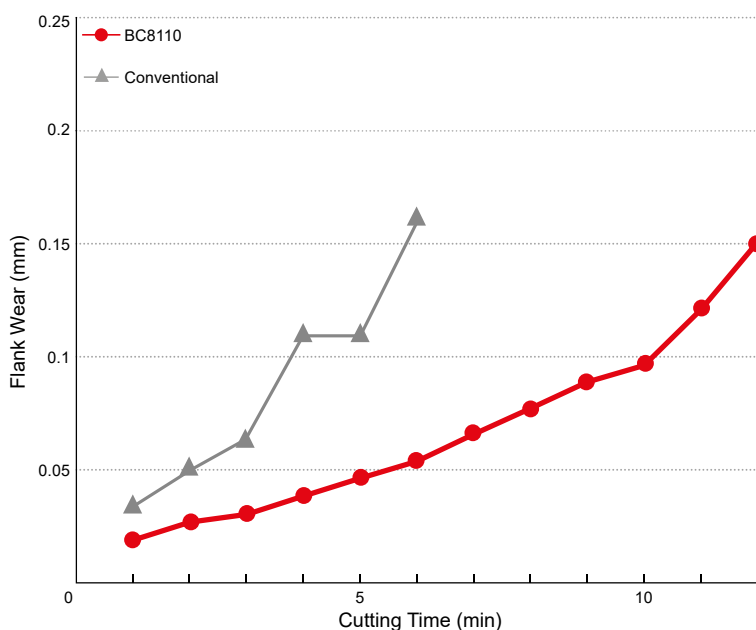

Insert	NP-CNGA120408GS2
Work Material	JIS SCr420 (60HRC)
Machining Methods	External Continuous Cutting
Cutting Speed Vc (m/min)	250
Feed f (mm/rev)	0.10
Depth of Cut ap (mm)	0.2
Cutting Mode	Dry Cutting

BC8120 General Application

Use of a CBN substrate with excellent fracture resistance and crater wear resistance, together with a coating film having superior wear resistance, combines both fracture resistance and wear resistance while exhibiting outstanding crater wear resistance.

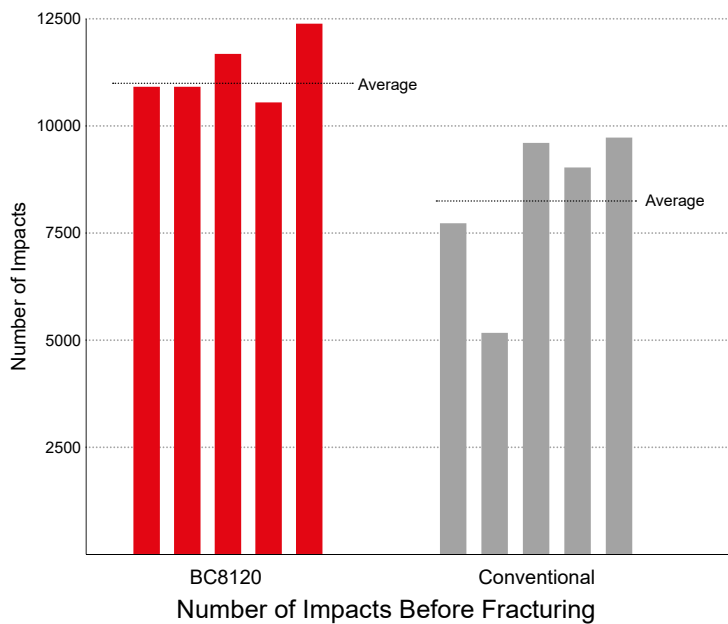

Cutting edge condition after 8000 impacts

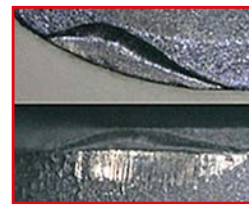

BC8120

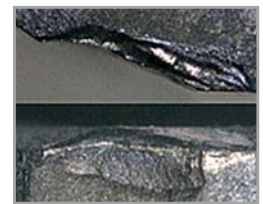

Conventional

Insert	NP-CNGA120408GA2
Work Material	JIS SCr420 (60HRC)
Machining Methods	External Interrupted Cutting
Cutting Speed V_c (m/min)	250
Feed f (mm/rev)	0.15
Depth of Cut a_p (mm)	0.1
Cutting Mode	Dry Cutting

BC8130 Tough Machining

Use of a CBN substrate with excellent cutting edge strength, together with a coating film that combines hardness with impact resistance, allows it to exhibit outstanding cutting edge strength and fracture resistance.

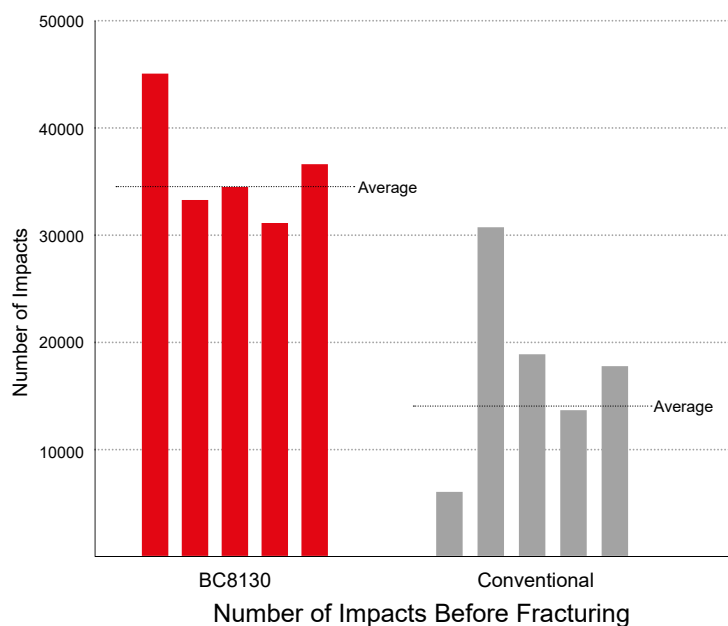

Insert	NP-CNGA120408GA2
Work Material	JIS SCr420 (60HRC)
Machining Methods	External Heavy Interrupted Cutting
Cutting Speed V_c (m/min)	250
Feed f (mm/rev)	0.05
Depth of Cut a_p (mm)	0.1
Cutting Mode	Wet Cutting

NON-COATED PCBN SERIES

MB8100 series for machining of hardened steel

FEATURES

The MB8100 series PCBN base material uses the optimized substrate technology (see B010) applied to the BC8100 series to prevent sudden defects during cutting and achieves long tool life.

The MB8100 series includes MB8110 for continuous cutting, MB8120 for general cutting and MB8130 for interrupted cutting and can be used over a very wide range of applications.

B

Application range

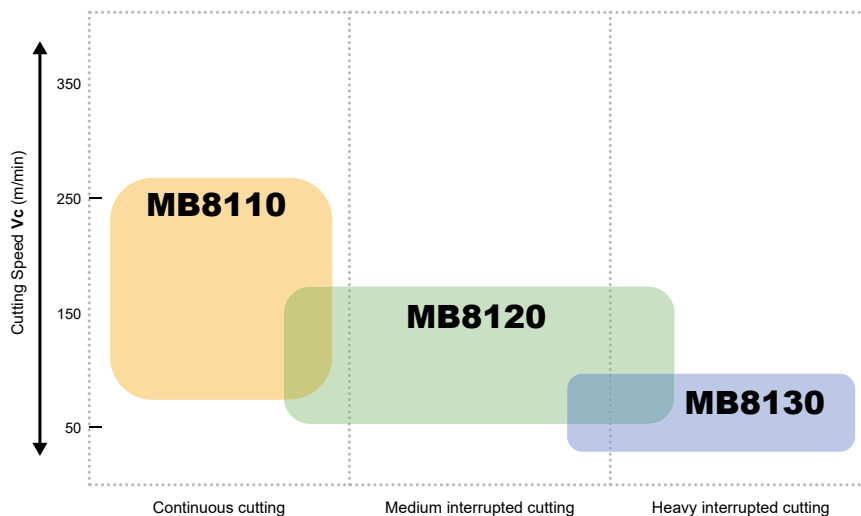

Recommended cutting conditions

Grade	Cutting mode	Cutting Speed Vc (m/min)					Feed f (mm/rev)	Depth of Cut ap (mm)	Cutting Mode
		50	100	150	200	250			
MB8110	Continuous			150 - 225			≤0.2	≤0.3	Dry, Wet
MB8120	Continuous			150 - 200			≤0.2	≤0.5	Dry, Wet
	Interrupted		100 - 150			≤0.2	≤0.3	Dry, Wet	
MB8130	Interrupted		100 - 150			≤0.2	≤0.3	Dry, Wet	

■ Application example

MB8110 Continuous cutting

Tool Life (Flank Wear)

Insert	NP-CNGA120408GA2
Work Material	JIS SCr420 (60HRC)
Machining Methods	External Continuous Cutting
Cutting Speed Vc (m/min)	250
Feed f (mm/rev)	0.1
Depth of Cut ap (mm)	0.2
Cutting Mode	Dry Cutting

Cutting Edge after 180 sec.

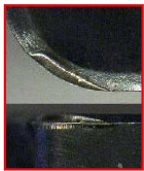

MB8110



Conventional

Large Wear

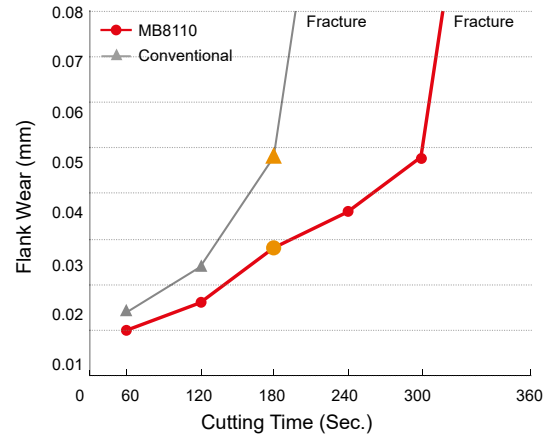

MB8120 General Application

Test of Interrupted Cutting

Insert	NP-CNGA120408GA2
Work Material	JIS SCr420 (60HRC)
Machining Methods	External Interrupted Cutting
Cutting Speed Vc (m/min)	250
Feed f (mm/rev)	0.15
Depth of Cut ap (mm)	0.1
Cutting Mode	Dry Cutting

17000 Impacts



MB8120

11000 Impacts

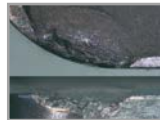

Conventional

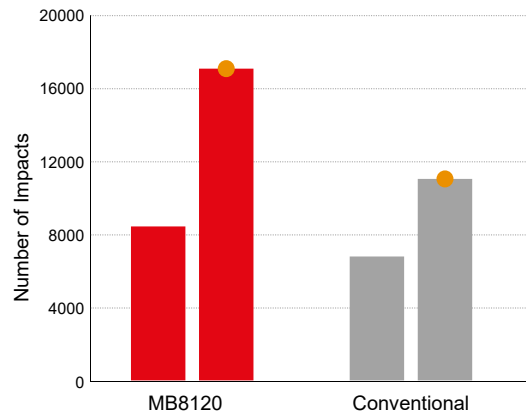

MB8130 Interrupted cutting

Test of Interrupted Cutting

Insert	NP-CNGA120408GA2
Work Material	JIS SCr420 (60HRC)
Machining Methods	External Heavy Interrupted Cutting
Cutting Speed Vc (m/min)	150
Feed f (mm/rev)	0.05
Depth of Cut ap (mm)	0.1
Cutting Mode	Wet Cutting

77000 Impacts



MB8130

54000 Impacts



Conventional

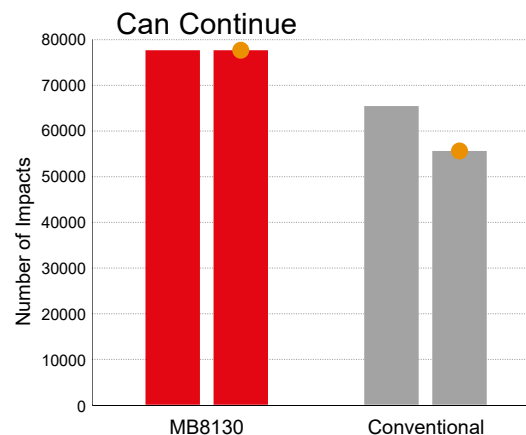

B

PCBN

Sintered Alloy Machining • Cast Iron Machining MB4120/BC5110/MB710/MB730/MBS140

Application Range

● Sintered Alloy Machining

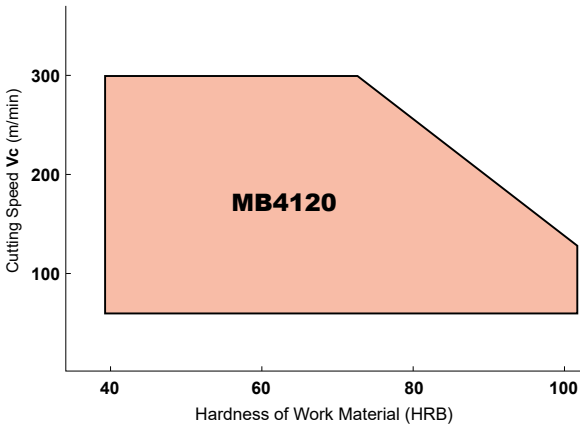

● Cast Iron Machining

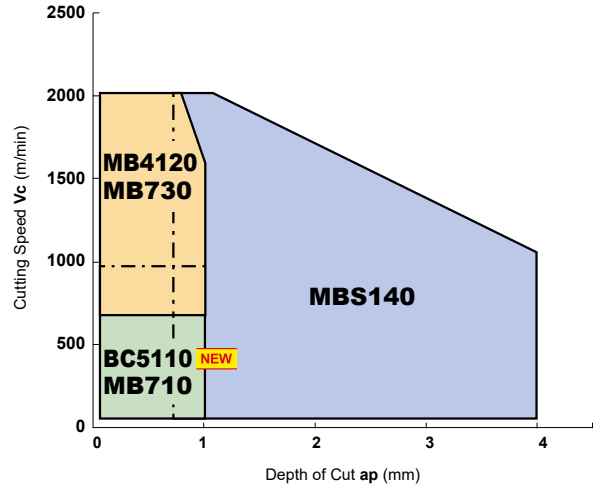

Recommended Cutting Conditions

● Sintered Alloy Machining

Work Material	Application range	Grade	Cutting Speed Vc (m/min)					Feed f (mm/rev)	Depth of Cut ap (mm)	Cutting Mode
			100	150	200	250	300			
General Sintered Alloy	General Cutting	MB4120	[Bar from 100 to 300]					≤0.2	≤0.3	Dry, Wet
High Density Sintered Alloy	General Cutting	MB4120	[Bar from 100 to 200]					≤0.2	≤0.3	Dry, Wet
Sintered Alloy	General Cutting	MB4120	[Bar from 100 to 150]					≤0.2	≤0.3	Dry, Wet

● Cast Iron Machining

Work Material	Application range	Grade	Cutting Speed Vc (m/min)							Feed f (mm/rev)	Depth of Cut ap (mm)	Cutting Mode
			100	250	500	600	750	1000	1250			
Gray Cast Iron GG25, GG30	General Cutting	MB4120	[Bar from 750 to 1250]							≤0.4	≤0.5	Dry, Wet
	General Cutting	MB730	[Bar from 1000 to 1250]							≤0.5	≤1.0	Dry, Wet
	General Cutting	MB710	[Bar from 500 to 1000]							≤0.5	≤1.0	Dry, Wet
	Low Cutting Speeds	BC5110 <small>NEW</small>	[Bar from 250 to 500]							≤0.5	≤0.5	Dry, Wet
	Heavy Cutting	MBS140	[Bar from 500 to 1500]							≤0.5	≤5	Dry, Wet

NON-COATED PCBN

Sintered Alloy Machining • Cast Iron Machining MB4120

● The first recommendation that can be widely used for continuous to interrupted cutting of sintered alloy and cast iron.

FEATURES

High fracture resistance

Fine CBN particles increase cutting edge toughness. The high fracture resistance allows stable performance even during interrupted machining.

High adhesion strength of fine CBN particles

Optimization of the sintering conditions strengthens adhesion between the fine CBN particles. This increases both fracture resistance and wear resistance.

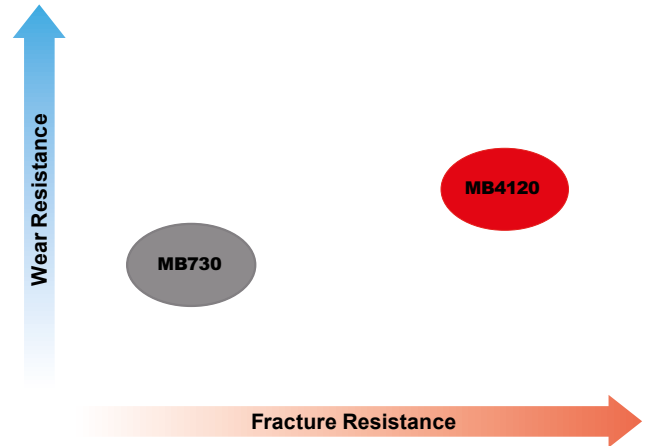

B

Application Example

Fracture resistance comparison during interrupted facing of high strength sintered alloy

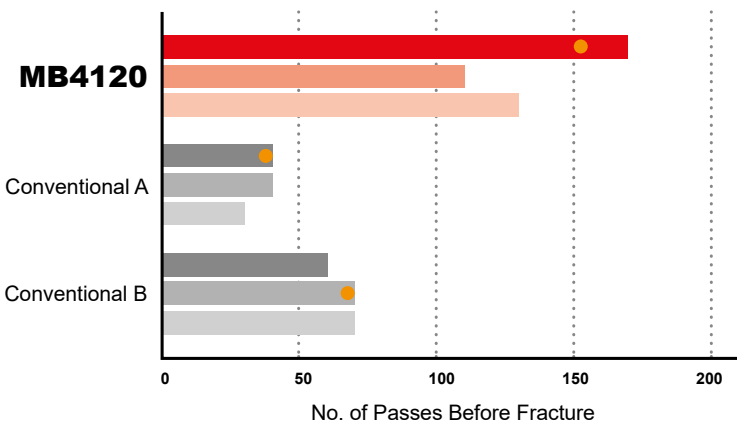

<Cutting Conditions>
 Work Material : High Strength Sintered Alloy
 Insert : NP-TNGA160408SE3
 Cutting Speed : Vc=150 m/min
 Feed : f=0.15 mm/rev
 Depth of Cut : ap=0.1 mm
 Cutting Mode : Wet Cutting

Comparison of continuous machining of DIN GG25

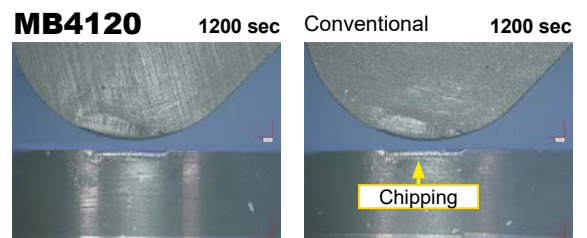
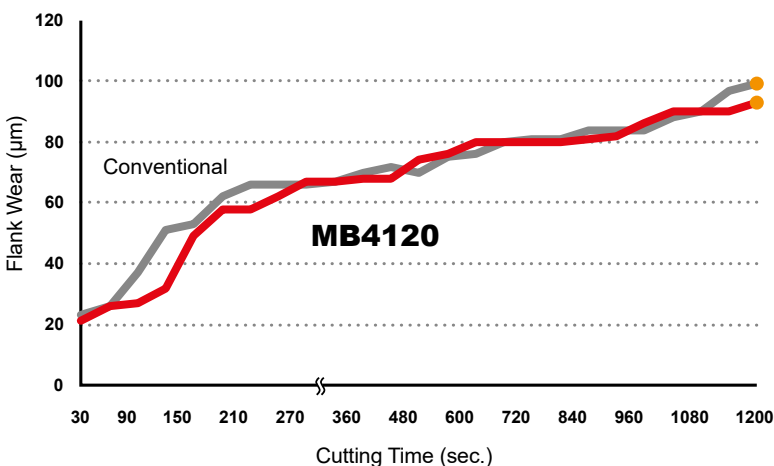

<Cutting Conditions>
 Work Material : DIN GG25 (Perlite)
 Insert : NP-TNGA160408SF3
 Cutting Speed : Vc=800 m/min
 Feed : f=0.1 mm/rev
 Depth of Cut : ap=0.2 mm
 Cutting Mode : Dry Cutting

COATED PCBN SERIES

Cast Iron Machining **BC5110**

FEATURES

BC5110 uses a tough substrate with a highly hard coating to provide excellent chipping and wear resistance.

B

Excellent Chipping Resistance

Compared to conventional grades, the fine grain and high CBN content greatly improves chipping resistance and provides stability and long tool life.

Excellent Wear Resistance Coating

The hard ceramic coating layer provides excellent surface finishes as well as wear and notch resistance during continuous cutting. Additionally, chipping and peeling of the coating layer is suppressed due to the improved bonding strength to the CBN substrate.

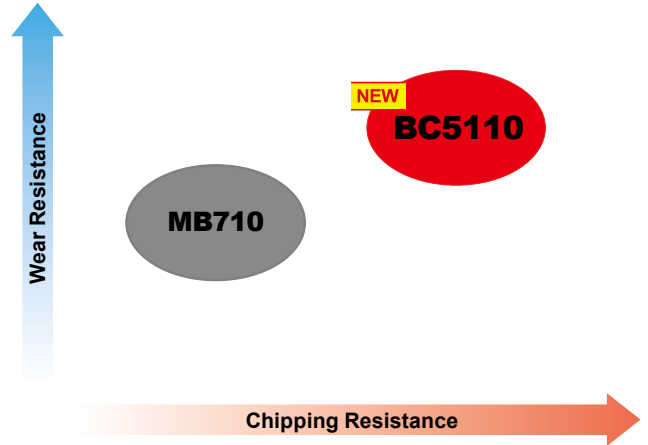

■ Machining FC250 : comparing wear resistance and surface roughness.

The tough substrate and wear resistant coating of BC5110 provides good surface finishes when compared to conventional uncoated grades.

Flank Wear Comparison

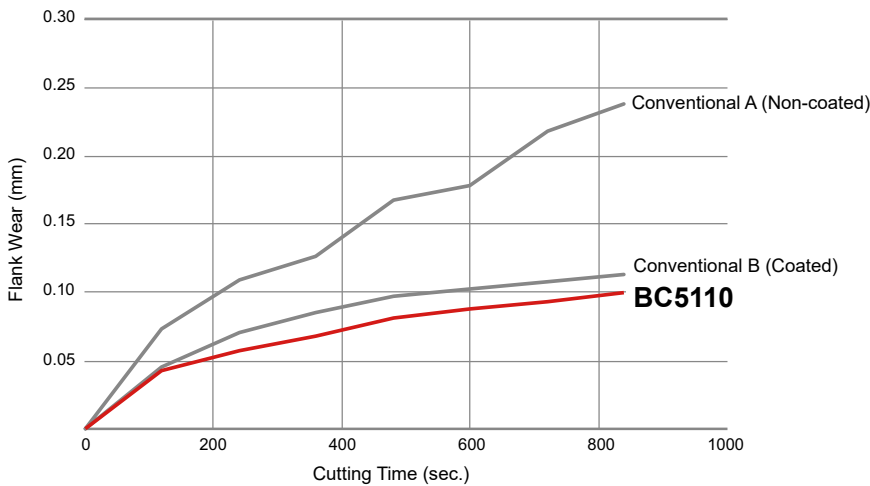

Finished Surface Comparison

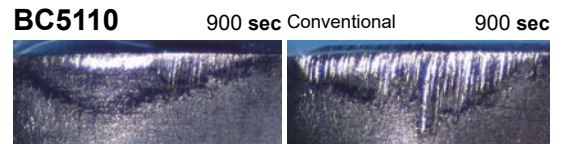
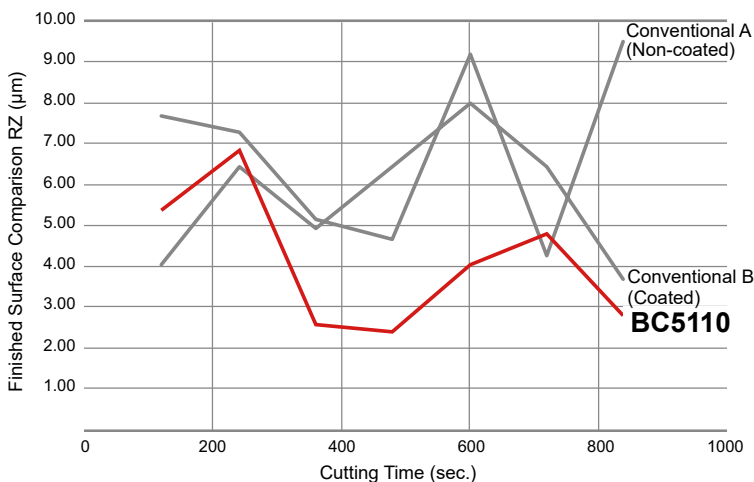

<Cutting Conditions>

Workpiece Material : JIS FC250
 Inserts : CNGA120408
 Machining Methods : External Continuous Cutting
 Cutting Speed : Vc = 300 m/min
 Feed per Rev. : fr=0.1 mm/rev
 Depth of Cut : ap = 0.2 mm
 Cutting Mode : Dry Cutting

SOLID PCBN

Cast Iron Machining MBS140

FEATURES

Supports high-efficiency machining with large depths of cut.

All inserts are solid PCBN sintered bodies, meaning there are no limits to the depths of cut.

Therefore, rough machining of cast iron, plus high-speed and high-efficiency machining, which is a characteristic of PCBN tools, can be achieved.

Combines wear resistance and fracture resistance

Use of micro-grain CBN with a newly-developed special binder provides high wear resistance.

Use of Mitsubishi Materials' original high-efficiency sintering technology provides high fracture resistance and supports machining at large depths of cut.

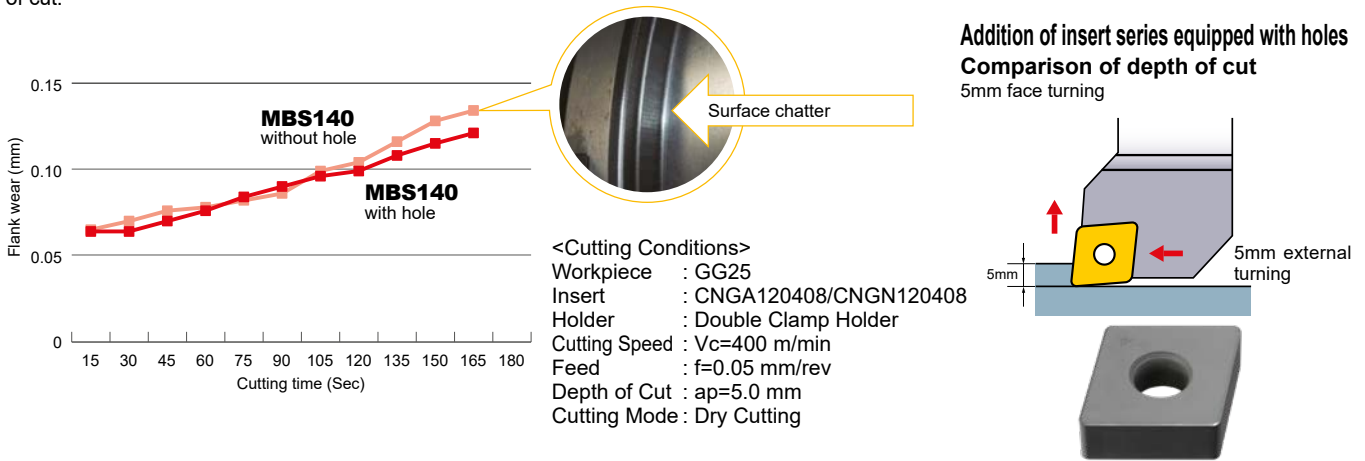

B

PCBN

FOR CYLINDER LINER MB5015

*Produced to order only.

FEATURES

MB5015 is an exclusive grade with high wear resistance for boring of centrifugal casting cylinder liners in semi finishing or finishing applications.

Recommended Cutting Conditions

Work Material	Cutting Mode	Cutting Speed V_c (m/min)				Feed f (mm/rev)	Depth of Cut a_p (mm)	Cutting Mode
		100	500	1000	1500			
Centrifugal casting	Cast Iron					-0.3(Finishing)	-0.05(Finishing)	Wet Cutting
						-0.8(Semi-finishing)	-0.2(Semi-finishing)	

Cutting Performance

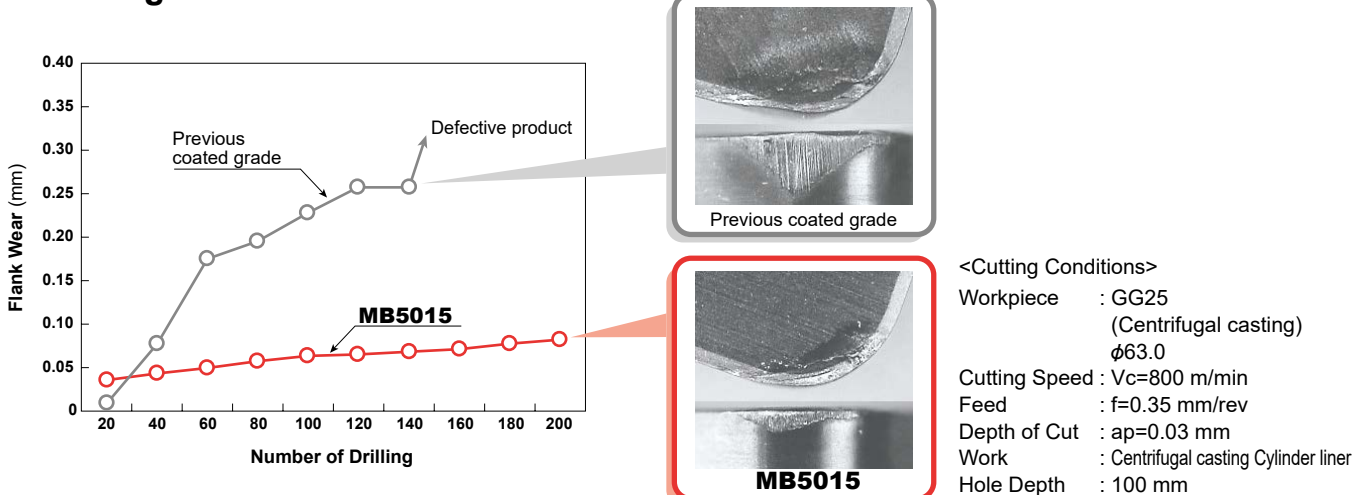

PCBN

- Suitable for high speed finishing of heat treated steel, sintered ferrous alloy and cast iron.
- Low affinity to iron, thus good surface finishes are possible.
- Grinding operations can be replaced by machining.



● Heat Treated Steel

Work Material	Type	Cutting Mode	Recommended Grade	Recommended Cutting Conditions			
				Cutting Speed Vc (m/min)	Feed f (mm/rev)	Depth of Cut ap (mm)	Cutting Mode
Structural Steel Esp. Carburized Steel High Alloy Steel	Coated	High speed finishing cutting	BC8105	250 (100–350)	≤0.15	≤0.2	Dry,Wet
		Continuous cutting for general purpose	NEW BC8210 BC8110	200 (100–300)	≤0.2	≤0.35	Dry,Wet
			NEW BC8220 BC8120	200 (100–230)	≤0.3	≤0.8	Dry,Wet
		Medium interrupted cutting	NEW BC8220 BC8120	150 (60–200)	≤0.2	≤0.3	Dry,Wet
	Non-coated	Interrupted cutting	BC8130	120 (60–150)	≤0.2	≤0.3	Dry,Wet
		Continuous cutting for general purpose	NEW MB8110	200 (100–250)	≤0.2	≤0.3	Dry,Wet
			NEW MB8120	150 (80–220)	≤0.2	≤0.5	Dry,Wet
		Medium interrupted cutting	NEW MB8120	130 (85–180)	≤0.2	≤0.3	Dry,Wet
Interrupted cutting	NEW MB8130	100 (60–150)	≤0.2	≤0.3	Dry,Wet		

● Cast Iron

Work Material	Workpiece Structure	Cutting Speed Vc (m/min)					Feed f (mm/rev)	Depth of Cut ap (mm)	Cutting Mode
		250	500	750	1000	1250			
Gray Cast Iron	GG25 Ferritic + Pearlitic	MBS140					-0.5	-1.0 MBS140/BC5110 -5.0	Dry,Wet
	GG30 Pearlitic	NEW BC5110	MB710	MB730					
Alloy Cast Iron	Pearlitic	MB4120				-0.4	-0.5	Dry,Wet	
Ductile Cast Iron	GGG40 Ferritic	MB710					-0.4	-0.5	Dry,Wet
	GGG70 Ferritic + Pearlitic/Pearlitic	MB730							

● Sintered Alloy

Work Material	Recommended Grade	Recommended Cutting Conditions		
		Cutting Speed Vc (m/min)	Feed f (mm/rev)	Depth of Cut ap (mm)
General Sintered Alloy	MB4120	180 (80–300)	-0.2	-0.3
High Density Sintered Alloy	MB4120	150 (80–230)	-0.2	-0.3
Sintered Alloy	MB4120	130 (80–180)	-0.2	-0.3

● Valve Seat

Amount of Hard Particles	← None or Small ————— Large →			
Hardness of Workpiece (HV)	150	250	300	350
Plunge Cut	MB4120		MB825	MB835
Traverse Cut	MB4120		MB710	MB825

● Roll

Work Material	Grade	Recommended Cutting Conditions		
		Cutting Speed Vc (m/min)	Feed f (mm/rev)	Depth of Cut ap (mm)
Ductile Cast Iron Granular Cast Iron Chilled Cast Iron	MB710	80 (30–130)	0.3 (0.1–0.5)	0.2–3.0
High Speed Steel	MB730	50 (20–70)	0.25 (0.1–0.4)	0.1–3.0
Cemented Carbide	MB730, MBS140	20 (10–30)	-0.2	-0.2

● Heat Resistant Alloy

Work Material	Grade	Recommended Cutting Conditions		
		Cutting Speed Vc (m/min)	Feed f (mm/rev)	Depth of Cut ap (mm)
Ni Base Heat Resistant Alloy (e.g. Inconel)	MB730	120 (100–150)	-0.2	-0.5
Co Base Heat Resistant Alloy (e.g. Stellite)	MB730	70 (50–100)	-0.2	-0.5

HONING

■ Honing for machining hardened steel

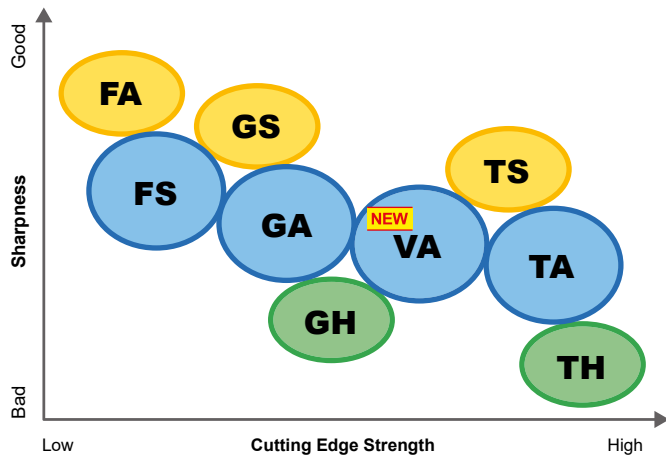

- **General cutting**
 - GA Honing : General machining
 - GS Honing : Vibration and burr control
 - GH Honing : For depths of cut of 0.15 or bigger
- **General cutting (For Fracture Resistance)**
 - VA Honing : High speeds and feed
- **Continuous cutting, stable cutting**
 - FS Honing : General machining
 - FA Honing : For improved initial cutting compared to FS
- **Medium and heavy interrupted cutting, unstable cutting**
 - TA Honing : General machining
 - TS Honing : Vibration and burr control
 - TH Honing : For depths of cut of 0.15 mm or larger

B

■ Honing for machining sintered alloys

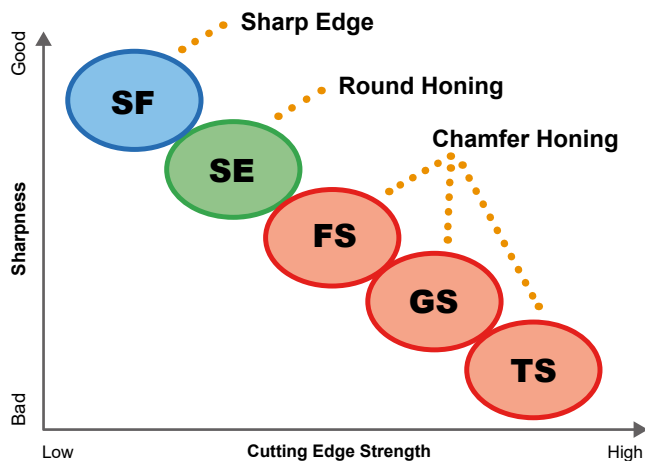

- **Continuous cutting, stable cutting**
 - FS Honing : Continuous cutting, General machining
- **Medium and heavy interrupted cutting, unstable cutting**
 - GS, TS Honing : If fracturing occurs at the cutting edge during interrupted cutting
- **High precision cutting**
 - SF Honing : Improve surface roughness
 - SE Honing : Chipping control

NP-CNGA120408-**G** **A** 2

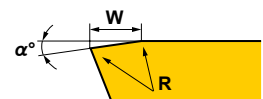

Main Application Edge Honing Type

(mm)

	A			S			H			F			E		
	General			Vibration and burr control			High efficiency			High accuracy			Chipping control		
	α	W	R	α	W	R	α	W	R	α	W	R	α	W	R
F Continuous cutting	15°	0.1	0	15°	0.1	0.015	—	—	—	—	—	—	—	—	—
G General cutting	25°	0.13	0.03	25°	0.13	0.015	25°	0.27	0.03	—	—	—	—	—	—
V For High Speed, High Feed Cutting	30°	0.13	0.04	—	—	—	—	—	—	—	—	—	—	—	—
T Interrupted cutting	35°	0.13	0.03	35°	0.13	0.015	35°	0.27	0.03	—	—	—	—	—	—
S High precision cutting	—	—	—	—	—	—	—	—	—	0	0	0	0	0	0.01

Conventional honing shapes
F honing : 0.1mm×15°+R0
G honing : 0.13mm×25°+R0.03
T honing : 0.13mm×35°+R0.03

PCBN BREAKER INSERT

FEATURES

Chipbreaker Geometry Designed for Excellent Chip Control

Radial chipbreaker ensures optimization of the cutting point and the chipbreaker position.

Enables effective chip discharge even when copy machining and prevents the chips from wrapping around the holder under finish cutting conditions.

Long Life Coated PCBN Grade

Combination of coating grade & breaker, high efficiency and long tool life over a wide variety of applications.

B

■ Chipbreaker

● BM Breaker (High depth of cut)

Good for high depth cutting of carburized layer.

Recommend under $a_p=0.6$ mm

★Available in BC8120 & BC8220 grade.

● BF Breaker (Light cutting depth)

Good for chip removal under light depth and feed cutting.

Recommend under $a_p=0.3$ mm

★Available in BC8120 & BC8220 grade.



BM Breaker

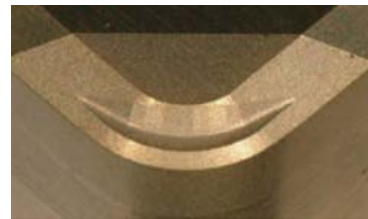

BF Breaker

■ Application Area

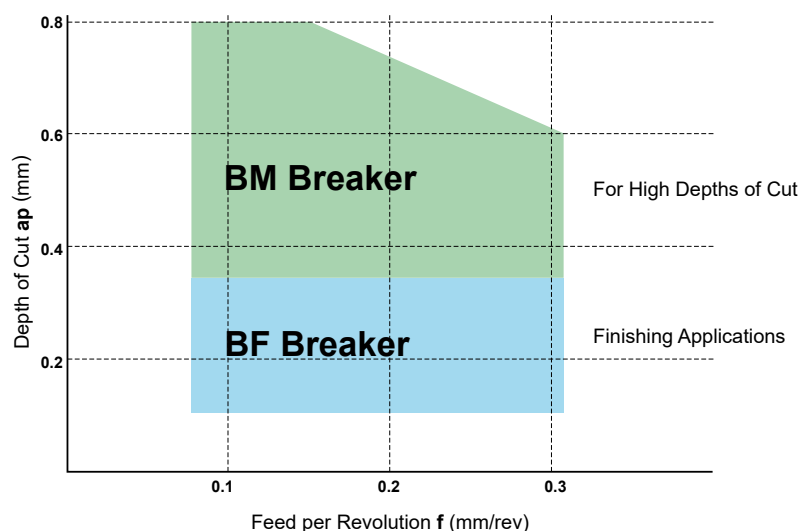

Application Example

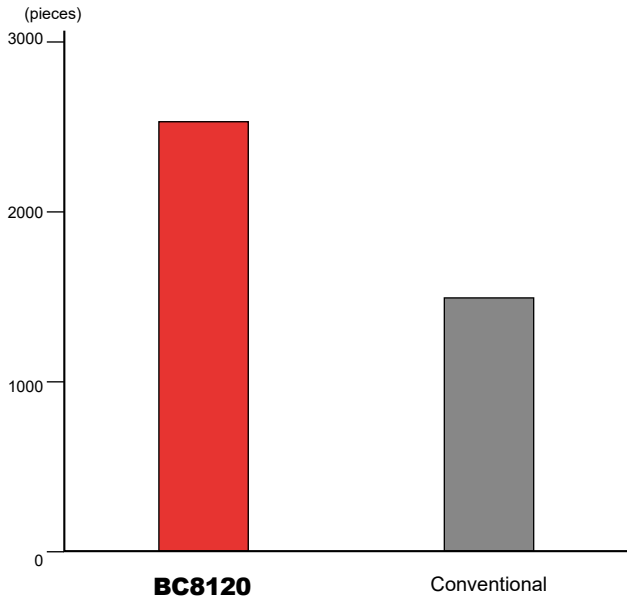

BC8120 achieved 1.5X longer tool life.

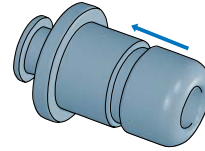

<Cutting Conditions>
 Workpiece : 42CrMoS4 (56-59HRC)
 Component : Counter shaft
 (External interrupted cutting)
 Insert : BM-DNGM150608TA2
 Cutting Speed : $V_c=170$ m/min
 Feed : $f=0.15$ mm/rev
 Depth of Cut : $a_p=0.07-0.10$ mm
 Cutting Mode : Dry Cutting

B

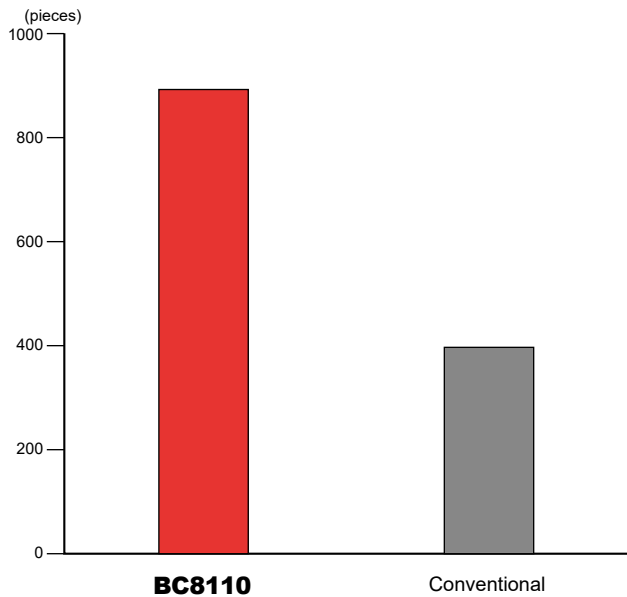

BC8110 achieved 1.3X longer tool life.

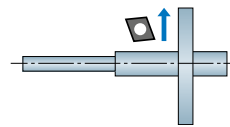

<Cutting Conditions>
 Workpiece : Alloy steel (61-65HRC)
 Component : Counter shaft
 (Continuous facing)
 Insert : BF-DNGM150404TA2
 Cutting Speed : $V_c=150$ m/min
 Feed : $f=0.12$ mm/rev
 Depth of Cut : $a_p=0.15$ mm
 Cutting Mode : Wet Cutting

MULTI-CORNER TYPE INSERTS

● A single sided, multi-corner type insert has no cutting edges on the underside.

Double Sided, multi-corner type insert, ex.

NP-CNGA120408GA4
 No. of Cutting Edge Corners 4

Single Sided, multi-corner type insert, ex.

NP-CNGA120408GA2
 No. of Cutting Edge Corners 2

Double sided, multi-corner type insert

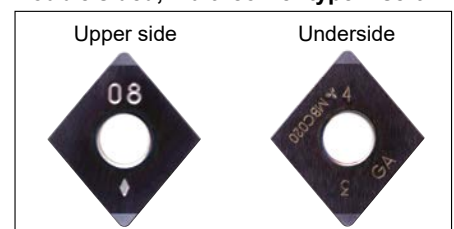

WIPER INSERT

FEATURES

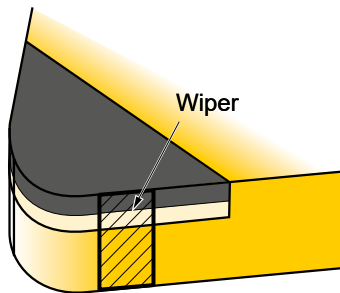

Improving Surface Finish

Under the same machining conditions as conventional breakers, but with the feed rate increased, the surface finish of the workpiece can be improved.

Improving Efficiency

High feed rates not only shorten machining times but also make it possible to combine roughing and finishing operations.

Increased Tool Life

When using high feed conditions, the time required to cut one component is decreased, thus more parts can be machined with each insert. In addition, the high feed rate prevents rubbing, therefore, delaying the progression of wear and increasing tool life of the insert.

Improving Chip Control

Under high feed conditions, the chips generated become thicker and are more easily broken, thus, chip control is improved.

Application of Wiper Inserts

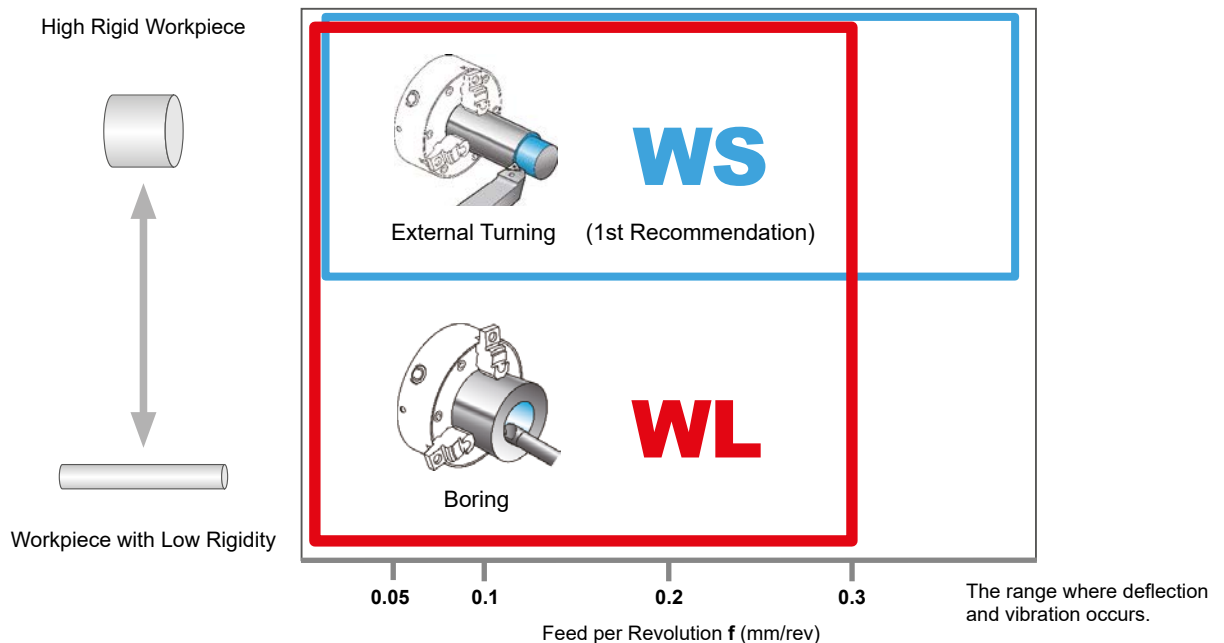

WL Wiper Insert

Preventing the cutting edge from vibration during boring and turning of small diameter workpieces as well as providing excellent surface finish roughness.

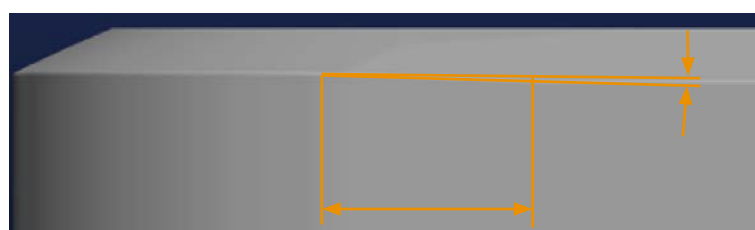

Applying a slight slope on the wiper cutting edge reduces cutting resistance.

Cutting Performance

WS Wiper (External Turning)

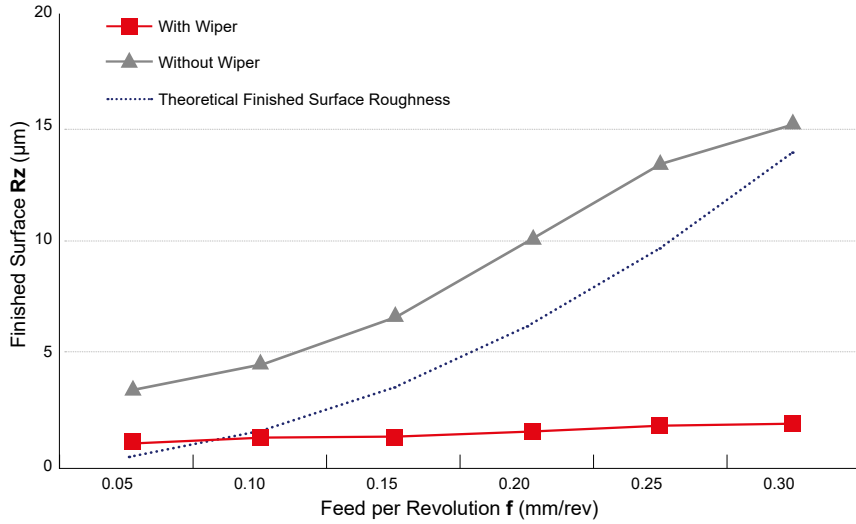

<Cutting Conditions>

Work Material : Hardened Steel (60HRC)
 Insert : NP-CNGA120408
 Machining Methods : Continuous
 Cutting Speed : $V_c = 120 \text{ m/min}$
 Depth of Cut : $a_p = 0.1 \text{ mm}$
 Cutting Mode : Dry Cutting

B

WL Wiper (Boring)

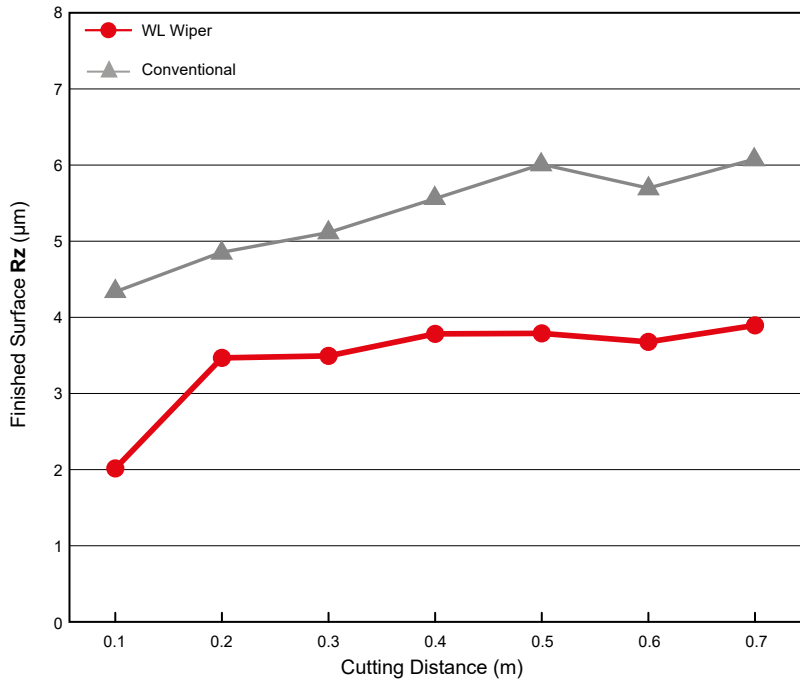

<Cutting Conditions>

Work Material : JIS SCr415 (60HRC)
 Insert : NP-CNGA120408FBWL2
 Machining Methods : Continuous
 Cutting Speed : $V_c = 160 \text{ m/min}$
 Feed : $f = 0.3 \text{ mm/rev}$
 Depth of Cut : $a_p = 0.1 \text{ mm}$
 Cutting Mode : Dry Cutting

A good surface finish is maintained even during unstable machining.

Notes for Use

No Restriction for Holders

A standard holder can be used.
 (*A double clamp, high rigidity tool is recommended.)

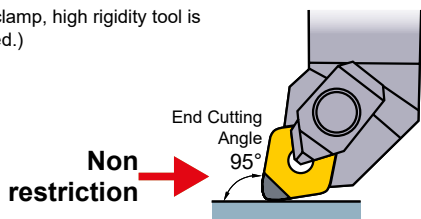

Restriction for Holders

Use a holder with end cutting angle 93° for improving wiper efficiency. A holder with end cutting angle 91° can improve wiper efficiency, however, there is no wiper efficiency with other end cutting angles ($60^\circ, 90^\circ, 107^\circ$ etc.).

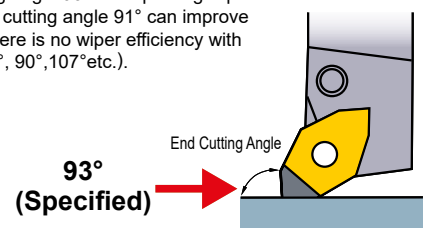

Combination of BF Breaker and WS Wiper Insert

CNGM and DNGM types are now available with new inserts that combine a BF chipbreaker with a WS wiper insert. (BC8210 : BF-○NGM○○○○○○○TSWS2, BC8220 : BF-○NGM○○○○○○○TAWS2)
It is effective for chip control and improvement of finished surface roughness without worrying about the hand of the tool even when continuous external or internal turning and facing.

B

Effect of Chipbreaker and Wiper Insert

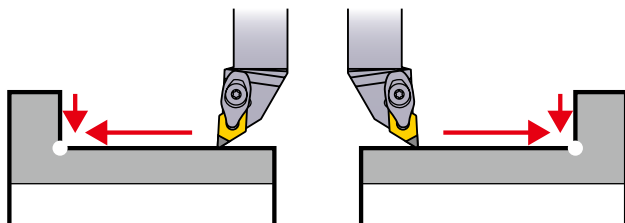

Demonstrates the effects of breaker and wiper insert in both right and left handed cutting.

BF Chipbreaker

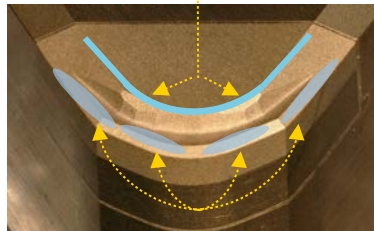

WS Wiper Insert (Neutral)

Notes for Use

When using CNGM type

No Restriction for Holders

A standard holder can be used.
(*A double clamp, high rigidity tool is recommended.)

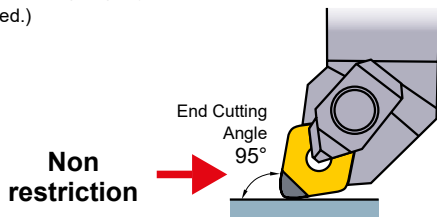

When using DNGM type

Restriction for Holders

Use PDJN holder or DDJN holder with an end cutting angle 93° for improving wiper efficiency. There is no wiper efficiency with other end cutting angles (60°, 90°, 107° etc.).

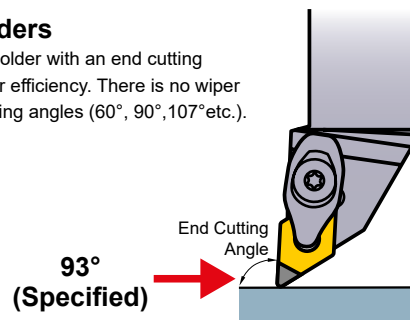

IDENTIFICATION

BF -CNGM120408 **TA** **WS** 2 **__**

Insert Geometry	
BM	With Breaker
BF	With Breaker
NP	New Petit Cut

Edge Preparation	
Symbol	Application
FS	Continuous Cutting
GS GA GH	General Cutting
VA	For High Speed, High Feed Cutting
TS TA TH	Interrupted Cutting

Wiper	
WS	For High Rigidity Workpiece Material
No Mark	Without Wiper

Cutting Direction		
Symbol	Hand	Figure
JR	Right	
JL	Left	
No Mark	Neutral	

PCBN GROOVING SERIES (GY/MG)

FEATURES

A combination with a high rigidity holder ensures high accuracy and long tool life.

Holder rigidity is essential when grooving hardened steel. The GY series TriForce system offers high rigidity equivalent to a solid type tool. MG has a wide insert location face for high gripping force. The insert and holder combination allows delivery of excellent performance when grooving hardened steel.

BC8110 coated materials for continuous machining of hardened steel have been added to GY inserts.

BC8110 materials with excellent wear resistance have been added. Compared to conventional materials, they display excellent wear resistance to achieve long tool life. A blade width of 6 mm has also been added to the lineup of BC8110.



Recommended Cutting Conditions

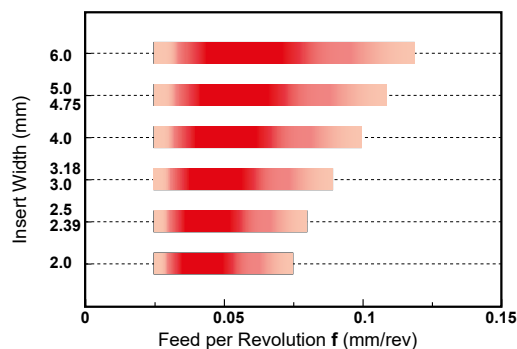

Work Material	Hardness	Grade	Cutting Speed Vc (m/min)	Cutting Mode
H Hardened Steel	35—65HRC	BC8110	100 (60—120)	Dry, Wet

Cutting Performance

Tool life evaluation for the GY holder

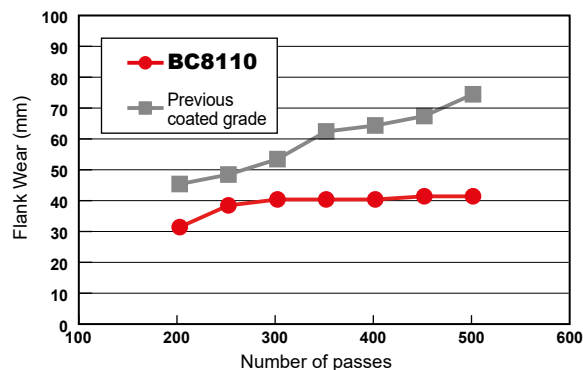

<Cutting Conditions>

Insert : GY1G0200D020N-GFGS
 Workpiece : JIS SG420 (60HRC)
 Cutting Speed : Vc=120 m/min
 Feed : f=0.1 mm/rev
 Depth of Cut : ap=0.3 mm
 Cutting Mode : Dry Cutting

Application Example

Insert	GY1G0300F020N-GFGS (Grade : BC8110)	
Workpiece	<p>Alloy steel (58—62HRC)</p>	
Component	Input shaft	
Cutting Conditions	Cutting Speed Vc (m/min)	130
	Feed f (mm/rev)	0.1
Result	<p>Tool life over twice as long as conventional products</p>	

PCD (SINTERED DIAMOND)

- Suitable for materials such as aluminium alloy, non-ferrous metals and fibre strengthened plastic.
- Suitable for extremely high speed finishing.

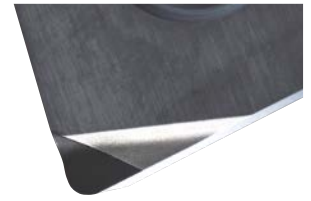

FEATURES

B

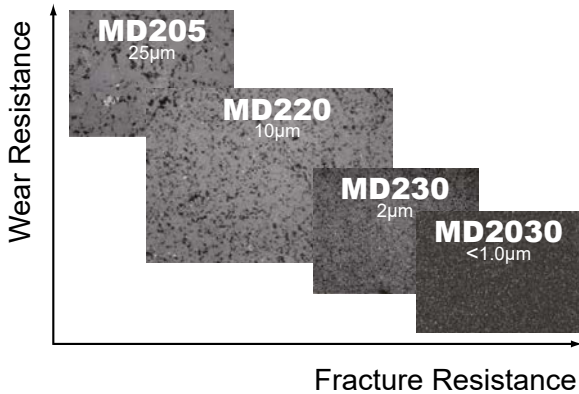

Grade	Features
MD205*	For Continuous Cutting Coarse grain diamond particles are sintered and wear resistance is excellent. Use when wear resistance with MD220 is insufficient.
MD220	Materials for general machining Sintered medium grain diamond particles. Wear resistance and fracture resistance are superbly balanced. Applicable to general finishing of non-ferrous metals, non-metal cutting, and similar machining.
MD230*	For Interrupted Cutting Fine grain diamond particles are used. Fracture resistance and cutting edge sharpness are excellent. Use when fracture and a high quality finished surface is demanded with MD220.
MD2030	For Heavy Interrupted Cutting Strong sintering of ultra micro-grain PCD particles provides exceptional fracture resistance. Chipping during high-speed finish milling can be controlled.

* MD205, MD230 : Non-Standard

SELECTION STANDARD

TURNING

Work Material	Recommended Grade			Recommended Cutting Conditions		
	MD205	MD220	MD2030	Cutting Speed Vc (m/min)	Feed f (mm/rev)	Depth of Cut ap (mm)
Aluminium Alloy (Si ≤ 12%)		◎	○	800 (200–1200)	–0.2	–1.0
Aluminium Alloy (Si > 13%)	◎	○		600 (200–1000)	–0.2	–1.0
Copper Alloy		◎		700 (200–1200)	–0.2	–1.0
Strengthened Plastic		◎		600 (100–1000)	–0.4	–1.0
Glass Fibre Reinforced Plastic		◎		500 (100–800)	–0.25	–1.0
Carbon	○	◎		400 (100–600)	–0.3	–1.0
Ceramics		○		50 (30–80)	–0.1	–1.0
Hard Rubber		◎		600 (300–800)	–0.15	–1.0
Wood Inorganic Board		◎		1300 (300–4000)	–0.4	–
Cemented Carbide	◎	○		15 (5–20)	–0.2	–0.5

Note 1) ◎ : 1st recommendation. ○ : 2nd recommendation
Note 2) Not suitable for steel.

PETIT CUT INSERT SERIES

- **Economical** The small PCD tip delivers long tool life.
Eliminates the need for regrinding, making tool management easier and economical.
- **With Breaker** Chipbreaker formed directly on the PCD portion delivers superior chip control.
- Corner R0.05 mm inserts are available, making it suitable for the machining of small work corner radii.

Memo

A series of horizontal dashed lines for writing.

















CLASSIFICATION

NEGATIVE INSERTS WITH HOLE

Product Name	Type	Tolerance	Breaker Name and Cross Section	Rhombic 80°	Rhombic 55°	Square 90°	Triangular 60°	Rhombic 35°	Trigon 80°
NEW PETIT CUT	Multi-corner Type Double Sided	G	Flat Top	NP-CNGA_04 ↻ B036	NP-DNGA_04 ↻ B039		NP-TNGA_06 ↻ B044	NP-VNGA_04 ↻ B046	NP-WNGA_06 ↻ B048
	Multi-corner Type Double Sided With Wiper		Flat Top	NP-CNGA_0W04 ↻ B036					
	Multi-corner Type Single Sided		Flat Top	NP-CNGA_02 ↻ B037	NP-DNGA_02 ↻ B040	NP-SNGA_02 ↻ B043	NP-TNGA_03 ↻ B044	NP-VNGA_02 ↻ B046	NP-WNGA_03 ↻ B048
	Multi-corner Type Single Sided With Wiper		Flat Top	NP-CNGA_0W02 ↻ B038	NP-DNGA_0WS2J_R/L ↻ B042				NP-WNGA_0WS3 ↻ B048
	Multi-corner Type Single Sided With Breaker		BF	BF-CNGM_02 ↻ B038	BF-DNGM_02 ↻ B042				
	Multi-corner Type Single Sided With Breaker With Wiper		BF	BF-CNGM_0WS2 ↻ B038	BF-DNGM_0WS2 ↻ B042				
	Multi-corner Type Single Sided With Breaker		BM	BM-CNGM_02 ↻ B038	BM-DNGM_02 ↻ B042		BM-TNGM_03 ↻ B045		
	One-corner Type Single Sided With Breaker		M	R-F	NP-CNMM_R-F ↻ B064	NP-DNMM_R-F ↻ B064	NP-SNMM_R-F ↻ B065	NP-TNMM_R-F ↻ B065	NP-VNMM_R-F ↻ B066





B

NEGATIVE INSERTS WITH HOLE

Product Name	Type	Tolerance	Breaker Name and Cross Section	Rhombic 80°	Rhombic 55°	Square 90°	Triangular 60°	Rhombic 35°	Trigon 80°
STANDARD	Multi-corner Type Double Sided (Solid PCBN)	G	Flat Top 	 CNGA  ↻ B038		 SNGA  ↻ B043	 TNGA  ↻ B045		
	One-corner Type Single Sided	M	Flat Top 	 CNMA  ↻ B064					
	One-corner Type Single Sided	G	Flat Top 		 DNGA  ↻ B064			 TNGA  ↻ B065	 VNGA  ↻ B066





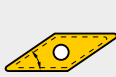













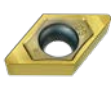





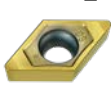

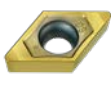



B

5° POSITIVE INSERTS WITH HOLE

Product Name	Type	Tolerance	Breaker Name and Cross Section	Rhombic 80°	Rhombic 55°	Square 90°	Triangular 60°	Rhombic 35°	Trigon 80°
NEW PETIT CUT	Multi-corner Type	G	Flat Top 					 NP-VBGW_02  ↻ B059	
	One-corner Type With Breaker		R-F 					 NP-VBGT_R-F  ↻ B071	

CLASSIFICATION

7° POSITIVE INSERTS WITH HOLE

Product Name	Type	Tolerance	Breaker Name and Cross Section	Rhombic 80° 	Rhombic 55° 	Square 90° 	Triangular 60° 	Rhombic 35° 	Trigon 80° 
NEW PETIT CUT	Multi-corner Type	G	Flat Top 	NP-CCGW/B_02  ↻ B051	NP-DCGW_02  ↻ B054		NP-TCGW_03  ↻ B056	NP-VCGW_02  ↻ B060	
	Multi-corner Type With Wiper	G	Flat Top 	NP-CCGW_0W02  ↻ B052					
	Multi-corner Type With Breaker	G	BF 	BF-CCGT_02  ↻ B052	BF-DCGT_02  ↻ B055				
	Multi-corner Type With Breaker	G	BM 	BM-CCGT_02  ↻ B052	BM-DCGT_02  ↻ B055				
	One-corner Type With Breaker	M	Breaker 	NP-CCMH  ↻ B067					
	One-corner Type	G	Flat Top 	NP-CCGW_0  ↻ B052	NP-DCGW_0  ↻ B055		NP-TCGW_0  ↻ B056		
	One-corner Type	M	Flat Top 						NP-WCMW_0  ↻ B060
	One-corner Type	M	Flat Top 	NP-CCMW  ↻ B067					
	One-corner Type With Breaker	M	R/L-F 		NP-DCMT_R/L-F  ↻ B068				
One-corner Type With Breaker	G	R-F 					NP-VCGT_R-F  ↻ B071		

B

7° POSITIVE INSERTS WITH HOLE

Product Name	Type	Tolerance	Breaker Name and Cross Section	Rhombic 80°	Rhombic 55°	Square 90°	Triangular 60°	Rhombic 35°	Trigon 80°
STANDARD	One-corner Type	M	Flat Top	CCMW	DCMW		TCMW TCGW	VCGW <small>NEW</small>	WCMW
		G		 ↻ B067	 ↻ B068		 ↻ B069	 ↻ B071	 ↻ B072



B

11° POSITIVE INSERTS WITH HOLE







Product Name	Type	Tolerance	Breaker Name and Cross Section	Rhombic 80°	Rhombic 55°	Square 90°	Triangular 60°	Rhombic 35°	Trigon 80°
NEW PETIT CUT	Multi-corner Type	G	Flat Top	NP-CPGB_02			NP-TPGB_03		
				 ↻ B053			 ↻ B057		
	One-corner Type With Breaker		Breaker	NP-CPMH					
				 ↻ B067					
NEW PETIT CUT	One-corner Type With Breaker	M	R/L-F				NP-TPMX_R/L-F		
							 ↻ B070		
NEW PETIT CUT	One-corner Type With Breaker		R/L-F				NP-TPMH_R/L-F		
							 ↻ B070		
STANDARD	One-corner Type With Breaker	G	Breaker	CPGT					WPGT
				 ↻ B067					 ↻ B072
STANDARD	One-corner Type		Flat Top			SPGX	TPGX		
						 ↻ B068	 ↻ B070		

CLASSIFICATION











15° POSITIVE INSERTS WITH HOLE

Type	Tolerance	Breaker Name and Cross Section	Rhombic 35°	
One-corner Type (For Aluminium With Breaker)	G	R-F 	VDGX_R-F  B074	

20° POSITIVE INSERTS WITH HOLE



Type	Tolerance	Breaker Name and Cross Section	Rhombic 55°	Triangular 60°
One-corner Type (For Aluminium With Breaker)	G	R/L 		TEGX_R/L  B073
One-corner Type (For Aluminium With Breaker)		R/L-F 	DEGX_R/L-F  B073	
One-corner Type (For Aluminium)		Flat Top 		TEGX  B073

NEGATIVE INSERTS WITHOUT HOLE

Type	Tolerance	Breaker Name and Cross Section	Rhombic 80°	Rhombic 55°	Square 90°	Triangular 60°	Round
Multi-corner Type Double Sided (Solid PCBN)	G	Flat Top					
			CNGN  ↻ B049	DNGN  ↻ B049	SNGN  ↻ B050	TNGN  ↻ B050	RNGN  ↻ B049

B





5° POSITIVE INSERTS WITHOUT HOLE

Type	Tolerance	Breaker Name and Cross Section	Triangular 60°
Multi-corner Type	G	Flat Top	
			TBGN  ↻ B062

SPECIAL PURPOSE INSERTS

Tool Holder Type	Tolerance	Inserts
GY Type	G	GY_GFGS  ↻ B063

11° POSITIVE INSERTS WITHOUT HOLE

Type	Tolerance	Breaker Name and Cross Section	Square 90°	Triangular 60°
Multi-corner Type	G	Flat Top		
			NP-SPGN_02 <small>NEW</small>  ↻ B061	
One-corner Type	G	Flat Top	SPGN  ↻ B061, B075	TPGN  ↻ B062, B075

PCBN TURNING INSERTS [NEGATIVE]

80° CN TYPE INSERTS WITH HOLE

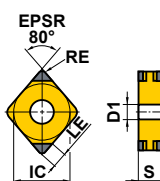
Work Material	H	Hardened Materials												Cutting Conditions (Guide) :					Geometry	Applicable Holder Page		
	K	Cast Iron												● : Stable Cutting ● : General Cutting ✖ : Unstable Cutting								
Shape	S	Heat-resistant Alloy, Titanium Alloy	Coated PCBN					PCBN					Solid PCBN	Dimensions (mm)								
		Sintered Alloy	NEW	NEW	NEW	NEW	NEW	NEW	NEW	NEW	NEW	NEW		IC	S	RE	LE	D1				
NEW PETIT CUT																					C008 C009 E015 E038 H006 -008	
				●	●	●								12.7	4.76	0.4	1.8	5.16				
				●	●	●								12.7	4.76	0.8	2.0	5.16				
				●	●	●								12.7	4.76	1.2	2.2	5.16				
				●		●	●		★					12.7	4.76	0.4	1.8	5.16				
				●		●	●		★					12.7	4.76	0.8	2.0	5.16				
				●		●	●		★					12.7	4.76	1.2	2.2	5.16				
				★	★	★	●							12.7	4.76	0.4	1.8	5.16				
				★	★	★	●							12.7	4.76	0.8	2.0	5.16				
				●	★	★	●							12.7	4.76	1.2	2.2	5.16				
				●	●									12.7	4.76	0.4	1.8	5.16				
				●	●									12.7	4.76	0.8	2.0	5.16				
				●	●									12.7	4.76	1.2	2.2	5.16				
				★		★			★					12.7	4.76	0.4	1.8	5.16				
				★		★			★					12.7	4.76	0.8	2.0	5.16				
				★		★			★					12.7	4.76	1.2	2.2	5.16				
				★		★								12.7	4.76	0.4	1.8	5.16				
				★		★								12.7	4.76	0.8	2.0	5.16				
				★		★								12.7	4.76	1.2	2.2	5.16				
			★		★								12.7	4.76	0.4	1.8	5.16					
			★		★								12.7	4.76	0.8	2.0	5.16					
			★		★								12.7	4.76	1.2	2.2	5.16					
NEW PETIT CUT (With Wiper) *			●	●	●								12.7	4.76	0.4	1.8	5.16					
			●	●	●								12.7	4.76	0.8	2.0	5.16					
			●	●	●								12.7	4.76	1.2	2.2	5.16					
			●		●	●		★					12.7	4.76	0.4	1.8	5.16					
			●		●	●		★					12.7	4.76	0.8	2.0	5.16					
			●		●	●		★					12.7	4.76	1.2	2.2	5.16					
			●	★	★	★		★					12.7	4.76	0.4	1.8	5.16					
			●	★	★	★		★					12.7	4.76	0.8	2.0	5.16					
			●	★	★	★		★					12.7	4.76	1.2	2.2	5.16					

* Please refer to B024 before using wiper inserts.

● = NEW

● : Inventory maintained. ★ : Inventory maintained in Japan.

Work Material	H	Hardened Materials	● ● ● ● ● ✱		● ● ● ✱		● ● ● ● ✱		● ● ● ● ✱		Cutting Conditions (Guide) : ● : Stable Cutting ● : General Cutting ✱ : Unstable Cutting Honing (Last letter of order number) : Please refer to page B021												
	K	Cast Iron	● ● ● ● ● ✱		● ● ● ✱		● ● ● ● ✱		● ● ● ● ✱														
Shape	S	Heat-resistant Alloy, Titanium Alloy	● ● ● ● ● ✱		● ● ● ✱		● ● ● ● ✱		● ● ● ● ✱		Dimensions (mm) IC S RE LE D1	Geometry	Applicable Holder Page										
		Sintered Alloy	● ● ● ● ● ✱		● ● ● ✱		● ● ● ● ✱		● ● ● ● ✱														
	Order Number		Coated PCBN					PCBN					Solid PCBN										
			NEW BC8210	BC8220	BC8105	BC8110	BC8120	BC8130	NEW BC5110	NEW MB8110	NEW MB8120	MB8130	MB4120	MB710	MB730	MBS140							
NEW PETIT CUT	NP-CNGA120402GS2	★			★												12.7	4.76	0.2	1.7	5.16		
	NP-CNGA120404GS2	●	●	●	●			★				●	●	●			12.7	4.76	0.4	1.8	5.16		
	NP-CNGA120408GS2	●	●	●	●			★				●	●	●			12.7	4.76	0.8	2.0	5.16		
	NP-CNGA120412GS2	●	●	●	●			★				★	●	●			12.7	4.76	1.2	2.2	5.16		
	NP-CNGA120402GA2	★			★				★								12.7	4.76	0.2	1.7	5.16		
	NP-CNGA120404GA2	●	●		●	●			●			●	●				12.7	4.76	0.4	1.8	5.16		
	NP-CNGA120408GA2	●	●		●	●			●								12.7	4.76	0.8	2.0	5.16		
	NP-CNGA120412GA2	●	●		●	●			●								12.7	4.76	1.2	2.2	5.16		
	NP-CNGA120404GH2	★	★		★	★	●										12.7	4.76	0.4	1.8	5.16		
	NP-CNGA120408GH2	★	★		★	★	●										12.7	4.76	0.8	2.0	5.16		
	NP-CNGA120412GH2	●	★		●	★	●										12.7	4.76	1.2	2.2	5.16		
NEW	NP-CNGA120404VA2		●														12.7	4.76	0.4	1.8	5.16		
NEW	NP-CNGA120408VA2		●														12.7	4.76	0.8	2.0	5.16		
NEW	NP-CNGA120412VA2		●														12.7	4.76	1.2	2.2	5.16		
	NP-CNGA120402FS2	★			★				★								12.7	4.76	0.2	1.7	5.16		
	NP-CNGA120404FS2	●	●	●	●	●		●	●			●	●				12.7	4.76	0.4	1.8	5.16		
	NP-CNGA120408FS2	●	●	●	●	●		●	●			●	●				12.7	4.76	0.8	2.0	5.16		
	NP-CNGA120412FS2	●	●	●	●	●		●	★			●	●				12.7	4.76	1.2	2.2	5.16		
	NP-CNGA120404TS2	●		●								★					12.7	4.76	0.4	1.8	5.16		
	NP-CNGA120408TS2	●		●								●					12.7	4.76	0.8	2.0	5.16		
	NP-CNGA120412TS2	●		●								★					12.7	4.76	1.2	2.2	5.16		
	NP-CNGA120404TA2	●			●	●			★	●			★				12.7	4.76	0.4	1.8	5.16		
	NP-CNGA120408TA2	●			●	●			★	●			●				12.7	4.76	0.8	2.0	5.16		
	NP-CNGA120412TA2	●			●	●			★	●			●				12.7	4.76	1.2	2.2	5.16		
	NP-CNGA120404TH2				★	●						●					12.7	4.76	0.4	1.8	5.16		
	NP-CNGA120408TH2	★			★	●						●					12.7	4.76	0.8	2.0	5.16		
	NP-CNGA120412TH2	★			★	●						●					12.7	4.76	1.2	2.2	5.16		
	NP-CNGA120404SF2											★					12.7	4.76	0.4	1.8	5.16		
	NP-CNGA120408SF2											●					12.7	4.76	0.8	2.0	5.16		
	NP-CNGA120412SF2											★					12.7	4.76	1.2	2.2	5.16		
	NP-CNGA120404SE2											★					12.7	4.76	0.4	1.8	5.16		
	NP-CNGA120408SE2											●					12.7	4.76	0.8	2.0	5.16		
	NP-CNGA120412SE2											★					12.7	4.76	1.2	2.2	5.16		

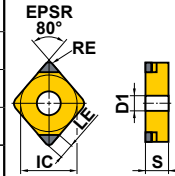

C008
C009
E015
E038
H006
-008

● = NEW

PCBN

B

PCBN TURNING INSERTS

NEG

WITH HOLE

C

D

R

S

T

V

W

PCBN TURNING INSERTS [NEGATIVE]

80° CN TYPE INSERTS WITH HOLE

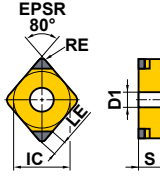
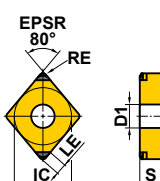
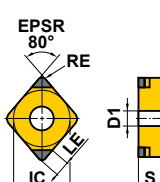
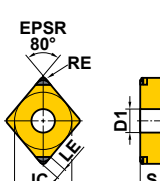
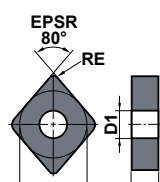
Work Material	H	Hardened Materials											Cutting Conditions (Guide) :					Geometry	Applicable Holder Page				
	K	Cast Iron											● : Stable Cutting ● : General Cutting ✖ : Unstable Cutting										
	S	Heat-resistant Alloy, Titanium Alloy											Honing (Last letter of order number) : Please refer to page B021										
Shape	Order Number	Coated PCBN					PCBN					Solid PCBN					Dimensions (mm)					Geometry	Applicable Holder Page
		NEW BC8210	BC8220	BC8105	BC8110	BC8120	BC8130	NEW BC5110	NEW MB8110	MB8120	MB8130	MB4120	MB710	MB730	MBS140	IC	S	RE	LE	D1			
NEW PETIT CUT (With Wiper) *1	NP-CNGA120404GSWS2	●	●	★											12.7	4.76	0.4	1.8	5.16	 C008 C009 E015 E038 H006 -008			
	NP-CNGA120408GSWS2	●	●	●											12.7	4.76	0.8	2.0	5.16				
	NP-CNGA120412GSWS2	●	●	★											12.7	4.76	1.2	2.2	5.16				
	NP-CNGA120404GAWS2	●		●	●			★							12.7	4.76	0.4	1.8	5.16				
	NP-CNGA120408GAWS2	●		●	●			★							12.7	4.76	0.8	2.0	5.16				
	NP-CNGA120412GAWS2	●		●	●			★							12.7	4.76	1.2	2.2	5.16				
	NP-CNGA120404GBWL2		★	★	★				★						12.7	4.76	0.4	1.8	5.16				
	NP-CNGA120408GBWL2		★	★	★				★						12.7	4.76	0.8	2.0	5.16				
	NP-CNGA120412GBWL2		★	★	★				★						12.7	4.76	1.2	2.2	5.16				
	NP-CNGA120404FSWS2	●	★	★	★			★							12.7	4.76	0.4	1.8	5.16				
	NP-CNGA120408FSWS2	●	●	●	★			★							12.7	4.76	0.8	2.0	5.16				
	NP-CNGA120412FSWS2	●	★	★	★			★							12.7	4.76	1.2	2.2	5.16				
	NP-CNGA120404FBWL2		★	★	★			★							12.7	4.76	0.4	1.8	5.16				
	NP-CNGA120408FBWL2		●	★	★			★							12.7	4.76	0.8	2.0	5.16				
NP-CNGA120412FBWL2		★	★	★			★							12.7	4.76	1.2	2.2	5.16					
NEW PETIT CUT	BF-CNGM120404TS2	●	●											12.7	4.76	0.4	1.8	5.16	 C008 C009 E015 E038 H006 -008				
	BF-CNGM120408TS2	●	●											12.7	4.76	0.8	2.0	5.16					
	BF-CNGM120412TS2	●	●											12.7	4.76	1.2	2.2	5.16					
(With Breaker)																							
NEW PETIT CUT (With Wiper) *1	BF-CNGM120408TSWS2	●												12.7	4.76	0.8	2.0	5.16	 C008 C009 E015 E038 H006 -008				
	BF-CNGM120412TSWS2	●												12.7	4.76	1.2	2.2	5.16					
NEW	BF-CNGM120408TAWS2	●												12.7	4.76	0.8	2.0	5.16					
(With Breaker)	BF-CNGM120412TAWS2	●												12.7	4.76	1.2	2.2	5.16					
NEW PETIT CUT	BM-CNGM120404TA2	●	●											12.7	4.76	0.4	1.8	5.16	 C008 C009 E015 E038 H006 -008				
	BM-CNGM120408TA2	●	●											12.7	4.76	0.8	2.0	5.16					
	BM-CNGM120412TA2	●	●											12.7	4.76	1.2	2.2	5.16					
(With Breaker)																							
	CNGA120408												★	12.7	4.76	0.8	-	5.16	 C008 C009 E015 E038 H006 -008				
	CNGA120412												★	12.7	4.76	1.2	-	5.16					

*1 Please refer to B024 before using wiper inserts.

● = NEW

● : Inventory maintained. ★ : Inventory maintained in Japan.

55° DN TYPE INSERTS WITH HOLE

Work Material	H	Hardened Materials	● ● ● ● ●		● ● ● ● ●		● ● ● ● ●		● ● ● ● ●		Cutting Conditions (Guide) : ● : Stable Cutting ● : General Cutting ✦ : Unstable Cutting Honing (Last letter of order number) : Please refer to page B021										
	K	Cast Iron	● ● ● ● ●		● ● ● ● ●		● ● ● ● ●		● ● ● ● ●												
S	Heat-resistant Alloy, Titanium Alloy	● ● ● ● ●		● ● ● ● ●		● ● ● ● ●		● ● ● ● ●													
	Sintered Alloy	● ● ● ● ●		● ● ● ● ●		● ● ● ● ●		● ● ● ● ●													
Shape	Order Number	Coated PCBN					PCBN					Solid PCBN	Dimensions (mm)					Geometry	Applicable Holder Page		
		NEW BC8210	BC8220	BC8105	BC8110	BC8120	BC8130	NEW BC5110	NEW MB8110	NEW MB8120	MB8130	MB4120	MB710	MB730	MBS140	IC	S			RE	LE
NEW PETIT CUT	NP-DNGA150404GS4	★	★	★											12.7	4.76	0.4	2.1	5.16		
	NP-DNGA150408GS4	★	★	★											12.7	4.76	0.8	2.0	5.16		
	NP-DNGA150412GS4	★	★	★											12.7	4.76	1.2	1.8	5.16		
	NP-DNGA150604GS4	●	●	●											12.7	6.35	0.4	2.1	5.16		
	NP-DNGA150608GS4	●	●	●											12.7	6.35	0.8	2.0	5.16		
	NP-DNGA150612GS4	●	●	●											12.7	6.35	1.2	1.8	5.16		
	NP-DNGA150404GA4	★		★	★			★							12.7	4.76	0.4	2.1	5.16		
	NP-DNGA150408GA4	★		★	★			★							12.7	4.76	0.8	2.0	5.16		
	NP-DNGA150412GA4	★		★	★			★							12.7	4.76	1.2	1.8	5.16		
	NP-DNGA150604GA4	●		●	●			★							12.7	6.35	0.4	2.1	5.16		
	NP-DNGA150608GA4	●		●	●			★							12.7	6.35	0.8	2.0	5.16		
	NP-DNGA150612GA4	●		●	●			★							12.7	6.35	1.2	1.8	5.16		
	NP-DNGA150404GH4	★	★	★	★	★									12.7	4.76	0.4	2.1	5.16		
	NP-DNGA150408GH4	★	★	★	★	★									12.7	4.76	0.8	2.0	5.16		
	NP-DNGA150412GH4	★	★	★	★	★									12.7	4.76	1.2	1.8	5.16		
	NP-DNGA150604GH4	★	★	★	★	●									12.7	6.35	0.4	2.1	5.16		
	NP-DNGA150608GH4	★	★	★	★	●									12.7	6.35	0.8	2.0	5.16		
	NP-DNGA150612GH4	★	★	★	★	●									12.7	6.35	1.2	1.8	5.16		
	NEW NP-DNGA150404VA4	★													12.7	4.76	0.4	2.1	5.16		
	NEW NP-DNGA150408VA4	★													12.7	4.76	0.8	2.0	5.16		
	NEW NP-DNGA150412VA4	★													12.7	4.76	1.2	1.8	5.16		
	NEW NP-DNGA150604VA4	★													12.7	6.35	0.4	2.1	5.16		
	NEW NP-DNGA150608VA4	★													12.7	6.35	0.8	2.0	5.16		
	NEW NP-DNGA150612VA4	★													12.7	6.35	1.2	1.8	5.16		
	NP-DNGA150404FS4	★	★	★	★			★							12.7	4.76	0.4	2.1	5.16		
	NP-DNGA150408FS4	★	★	★	★			★							12.7	4.76	0.8	2.0	5.16		
	NP-DNGA150412FS4	★	★	★	★			★							12.7	4.76	1.2	1.8	5.16		
	NP-DNGA150604FS4	★	●	★				★							12.7	6.35	0.4	2.1	5.16		
	NP-DNGA150608FS4	★	●	★				★							12.7	6.35	0.8	2.0	5.16		
	NP-DNGA150612FS4	★	●	★				★							12.7	6.35	1.2	1.8	5.16		
NP-DNGA150404TS4	★		★											12.7	4.76	0.4	2.1	5.16			
NP-DNGA150408TS4	★		★											12.7	4.76	0.8	2.0	5.16			
NP-DNGA150412TS4	★		★											12.7	4.76	1.2	1.8	5.16			
NP-DNGA150604TS4	★		★											12.7	6.35	0.4	2.1	5.16			
NP-DNGA150608TS4	★		★											12.7	6.35	0.8	2.0	5.16			
NP-DNGA150612TS4	★		★											12.7	6.35	1.2	1.8	5.16			
NP-DNGA150404TA4	★		★	★			★	★						12.7	4.76	0.4	2.1	5.16			
NP-DNGA150408TA4	★		★	★			★	★						12.7	4.76	0.8	2.0	5.16			
NP-DNGA150412TA4	★		★	★			★	★						12.7	4.76	1.2	1.8	5.16			
NP-DNGA150604TA4	★		★	●			★							12.7	6.35	0.4	2.1	5.16			
NP-DNGA150608TA4	★		★	●			★							12.7	6.35	0.8	2.0	5.16			
NP-DNGA150612TA4	★		★	●			★							12.7	6.35	1.2	1.8	5.16			

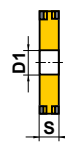
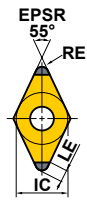
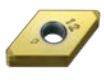

- C010
- C011
- E015
- E038
- 040
- H009
- 011

● = NEW

GRADES > B004
IDENTIFICATION > B002

PCBN

B

PCBN TURNING INSERTS

NEG

WITH HOLE

C

D

R

S

T

V

W

PCBN TURNING INSERTS [NEGATIVE]

55° DN TYPE INSERTS WITH HOLE

Work Material	H	Hardened Materials	Cutting Conditions (Guide): ●: Stable Cutting ●: General Cutting ✦: Unstable Cutting Honing (Last letter of order number): Please refer to page B021												Shape	Order Number	Coated PCBN					PCBN					Solid PCBN	Dimensions (mm)					Geometry	Applicable Holder Range					
	K	Cast Iron	BC8210	BC8220	BC8105	BC8110	BC8120	BC8130	NEW BC5110	NEW MB8110	NEW MB8120	MB8130	MB4120	MB710			MB730	MBS140	IC	S	RE	LE	D1																
S	Heat-resistant Alloy, Titanium Alloy	Sintered Alloy	●					● ● ● ● ●					● ● ● ● ● ✦																										
PCBN TURNING INSERTS	NEW PETIT CUT																																						
		NP-DNGA150404TH4							★ ★			★						12.7	4.76	0.4	2.1	5.16			C010 C011 E015 E038 -040 H009 -011														
		NP-DNGA150408TH4	★				★ ★			★							12.7	4.76	0.8	2.0	5.16																		
		NP-DNGA150412TH4	★				★ ★			★							12.7	4.76	1.2	1.8	5.16																		
		NP-DNGA150604TH4					★ ★										12.7	6.35	0.4	2.1	5.16																		
		NP-DNGA150608TH4	★				★ ★										12.7	6.35	0.8	2.0	5.16																		
	NP-DNGA150612TH4	★				★ ★										12.7	6.35	1.2	1.8	5.16																			
	NEW PETIT CUT	NP-DNGA150402GS2	★				★										12.7	4.76	0.2	2.2	5.16			C010 C011 E015 E038 -040 H009 -011															
		NP-DNGA150404GS2	★				★ ★			★						12.7	4.76	0.4	2.1	5.16																			
		NP-DNGA150404GS2											★ ★			12.7	4.76	0.4	1.5	5.16																			
		NP-DNGA150408GS2	★				★ ★			★						12.7	4.76	0.8	2.0	5.16																			
		NP-DNGA150408GS2											★ ★			12.7	4.76	0.8	1.7	5.16																			
		NP-DNGA150412GS2	★				★ ★			★ ★ ★						12.7	4.76	1.2	1.8	5.16																			
		NP-DNGA150604GS2	●				● ●			★ □ ●						12.7	6.35	0.4	2.1	5.16																			
		NP-DNGA150608GS2	●				● ●			★ ● ●						12.7	6.35	0.8	2.0	5.16																			
		NP-DNGA150612GS2	●				● ●			★ □ ●						12.7	6.35	1.2	1.8	5.16																			
		NP-DNGA110408GA2	●				● ●			●						9.525	4.76	0.8	2.0	3.81																			
		NP-DNGA150402GA2	★				★									12.7	4.76	0.2	2.2	5.16																			
		NP-DNGA150404GA2	★				★ ★			★						12.7	4.76	0.4	2.1	5.16																			
		NP-DNGA150408GA2	★				★ ★			★						12.7	4.76	0.8	2.0	5.16																			
		NP-DNGA150412GA2	★				★ ★			★						12.7	4.76	1.2	1.8	5.16																			
		NP-DNGA150602GA2					★									12.7	6.35	0.2	2.2	5.16																			
		NP-DNGA150604GA2	●				● ●			●						12.7	6.35	0.4	2.1	5.16																			
		NP-DNGA150608GA2	●				● ●			●						12.7	6.35	0.8	2.0	5.16																			
		NP-DNGA150612GA2	●				● ●			●						12.7	6.35	1.2	1.8	5.16																			
		NP-DNGA150404GH2	★ ★				★ ★ ★									12.7	4.76	0.4	2.1	5.16																			
NP-DNGA150408GH2		★ ★				★ ★ ★									12.7	4.76	0.8	2.0	5.16																				
NP-DNGA150412GH2		★ ★				★ ★ ★									12.7	4.76	1.2	1.8	5.16																				
NP-DNGA150604GH2	★ ★				★ ★ ●									12.7	6.35	0.4	2.1	5.16																					
NP-DNGA150608GH2	★ ★				★ ★ ●									12.7	6.35	0.8	2.0	5.16																					
NP-DNGA150612GH2	★ ★				★ ★ ●									12.7	6.35	1.2	1.8	5.16																					

● = NEW

● : Inventory maintained. ★ : Inventory maintained in Japan.
□ : Non stock, produced to order only.

Work Material	H	Hardened Materials												Cutting Conditions (Guide) : ● : Stable Cutting ● : General Cutting ✳ : Unstable Cutting							
	K	Cast Iron												Honing (Last letter of order number) : Please refer to page B021							
	S	Heat-resistant Alloy, Titanium Alloy																			
		Sintered Alloy																			
Shape	Order Number	Coated PCBN					PCBN					Solid PCBN	Dimensions (mm)					Geometry	Applicable Holder Page		
		NEW BC8210	BC8220	BC8105	BC8110	BC8120	NEW BC8130	NEW BC5110	NEW MB8110	NEW MB8120	MB8130	MB4120	MB710	MB730	MBS140	IC	S			RE	LE
NEW PETIT CUT	NEW NP-DNGA150404VA2	★													12.7	4.76	0.4	2.1	5.16		
	NEW NP-DNGA150408VA2	★													12.7	4.76	0.8	2.0	5.16		
	NEW NP-DNGA150412VA2	★													12.7	4.76	1.2	1.8	5.16		
	NEW NP-DNGA150604VA2	●													12.7	6.35	0.4	2.1	5.16		
	NEW NP-DNGA150608VA2	●													12.7	6.35	0.8	2.0	5.16		
	NEW NP-DNGA150612VA2	●													12.7	6.35	1.2	1.8	5.16		
	NP-DNGA150402FS2	★		★			★								12.7	4.76	0.2	2.2	5.16		
	NP-DNGA150404FS2	★	★	★	★		★	★		★					12.7	4.76	0.4	2.1	5.16		
	NP-DNGA150408FS2	★	★	★	★		★	★		★					12.7	4.76	0.8	2.0	5.16		
	NP-DNGA150412FS2	★	★	★	★		★	★		★					12.7	4.76	1.2	1.8	5.16		
	NP-DNGA150604FS2	●	●	●	●		★	★		●					12.7	6.35	0.4	2.1	5.16		
	NP-DNGA150608FS2	●	●	●	●		★	★		●					12.7	6.35	0.8	2.0	5.16		
	NP-DNGA150612FS2	●	●	●	●		●			●					12.7	6.35	1.2	1.8	5.16		
	NP-DNGA150404TS2	★		★						★					12.7	4.76	0.4	2.1	5.16		
	NP-DNGA150408TS2	★		★						★					12.7	4.76	0.8	2.0	5.16		
	NP-DNGA150412TS2	★		★						★					12.7	4.76	1.2	1.8	5.16		
	NP-DNGA150604TS2	●		●						★					12.7	6.35	0.4	2.1	5.16		
	NP-DNGA150608TS2	●		●						★					12.7	6.35	0.8	2.0	5.16		
	NP-DNGA150612TS2	●		●						★					12.7	6.35	1.2	1.8	5.16		
	NP-DNGA150404TA2	★		★	★			★	●						12.7	4.76	0.4	2.1	5.16		
	NP-DNGA150408TA2	★		★	★			★	●						12.7	4.76	0.8	2.0	5.16		
	NP-DNGA150412TA2	★		★	★			★	★						12.7	4.76	1.2	1.8	5.16		
	NP-DNGA150604TA2	●		●	●			★							12.7	6.35	0.4	2.1	5.16		
	NP-DNGA150608TA2	●		●	●			●							12.7	6.35	0.8	2.0	5.16		
	NP-DNGA150612TA2	●		●	●			★							12.7	6.35	1.2	1.8	5.16		
	NP-DNGA150404TH2			★	★					★					12.7	4.76	0.4	2.1	5.16		
	NP-DNGA150408TH2	★		★	★					★					12.7	4.76	0.8	2.0	5.16		
	NP-DNGA150412TH2	★		★	★					★					12.7	4.76	1.2	1.8	5.16		
	NP-DNGA150604TH2			★	★										12.7	6.35	0.4	2.1	5.16		
	NP-DNGA150608TH2	★		★	★										12.7	6.35	0.8	2.0	5.16		
	NP-DNGA150612TH2	★		★	★										12.7	6.35	1.2	1.8	5.16		
	NP-DNGA150404SF2									★					12.7	4.76	0.4	2.1	5.16		
	NP-DNGA150408SF2									★					12.7	4.76	0.8	2.0	5.16		
	NP-DNGA150412SF2									★					12.7	4.76	1.2	1.8	5.16		
	NP-DNGA150604SF2									★					12.7	6.35	0.4	2.1	5.16		
	NP-DNGA150608SF2									★					12.7	6.35	0.8	2.0	5.16		
	NP-DNGA150612SF2									★					12.7	6.35	1.2	1.8	5.16		
	NP-DNGA150404SE2									★					12.7	4.76	0.4	2.1	5.16		
	NP-DNGA150408SE2									★					12.7	4.76	0.8	2.0	5.16		
	NP-DNGA150412SE2									★					12.7	4.76	1.2	1.8	5.16		
	NP-DNGA150604SE2									★					12.7	6.35	0.4	2.1	5.16		
	NP-DNGA150608SE2									★					12.7	6.35	0.8	2.0	5.16		
	NP-DNGA150612SE2									★					12.7	6.35	1.2	1.8	5.16		

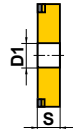
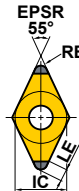

C010
C011
E015
E038
-040
H009
-011

● = NEW

PCBN

B

PCBN TURNING INSERTS

NEG

WITH HOLE

C

D

R

S

T

V

W

PCBN TURNING INSERTS [NEGATIVE]

55° DN TYPE INSERTS WITH HOLE

Work Material	H	Hardened Materials	●	●	●	●	●	●	●	●	●	●	●	●	●	Cutting Conditions (Guide) : ● : Stable Cutting ● : General Cutting ✦ : Unstable Cutting Honing (Last letter of order number) : Please refer to page B021	Geometry	Applicable Holder Page					
	K	Cast Iron	●	●	●	●	●	●	●	●	●	●	●	●	●								
	S	Heat-resistant Alloy, Titanium Alloy	●	●	●	●	●	●	●	●	●	●	●	●	●								
Shape	Order Number	Coated PCBN					PCBN					Solid PCBN					Dimensions (mm)					Right hand insert shown.	
		BC8210	BC8220	BC8105	BC8110	BC8120	BC8130	BC5110	MB8110	MB8120	MB8130	MB4120	MB710	MB730	MBS140	IC	S	RE	LE	D1			
PCBN B PCBN TURNING INSERTS NEG WITH HOLE C D R S T V W	NEW PETIT CUT (With Wiper) *	NP-DNGA150404GSWS2JR	★													12.7	4.76	0.4	1.8	5.16	 EPSR 55° RE IC LE D1 S		C010 C011 E015 E038 -040 H009 -011
		NP-DNGA150404GSWS2JL	★														12.7	4.76	0.4	1.8		5.16	
		NP-DNGA150408GSWS2JR	★														12.7	4.76	0.8	1.7		5.16	
		NP-DNGA150408GSWS2JL	★														12.7	4.76	0.8	1.7		5.16	
		NP-DNGA150604GSWS2JR	●														12.7	6.35	0.4	1.8		5.16	
		NP-DNGA150604GSWS2JL	●														12.7	6.35	0.4	1.8		5.16	
		NP-DNGA150608GSWS2JR	●														12.7	6.35	0.8	1.7		5.16	
		NP-DNGA150608GSWS2JL	●														12.7	6.35	0.8	1.7		5.16	
		NP-DNGA150404GAWS2JR	★		★				★								12.7	4.76	0.4	1.8		5.16	
		NP-DNGA150404GAWS2JL	★		★				★								12.7	4.76	0.4	1.8		5.16	
		NP-DNGA150408GAWS2JR	★		★				★								12.7	4.76	0.8	1.7		5.16	
		NP-DNGA150408GAWS2JL	★		★				★								12.7	4.76	0.8	1.7		5.16	
		NP-DNGA150604GAWS2JR	●		●				★								12.7	6.35	0.4	1.8		5.16	
		NP-DNGA150604GAWS2JL	●		●				★								12.7	6.35	0.4	1.8		5.16	
		NP-DNGA150608GAWS2JR	●		●				★								12.7	6.35	0.8	1.7		5.16	
	NP-DNGA150608GAWS2JL	●		●				★								12.7	6.35	0.8	1.7	5.16			
	NEW PETIT CUT	BF-DNGM150404TS2	★	●												12.7	4.76	0.4	2.1	5.16	 EPSR 55° RE IC LE D1 S	C010 C011 E015 E038 -040 H009 -011	
		BF-DNGM150408TS2	★	●												12.7	4.76	0.8	2.0	5.16			
		BF-DNGM150412TS2	★	●												12.7	4.76	1.2	1.8	5.16			
	(With Breaker)																						
	NEW PETIT CUT (With Wiper) *	BF-DNGM150408TSWS2	★													12.7	4.76	0.8	2.4	5.16	 55° EPSR RE IC LE D1 S	C010 C011 E015 E038 -040 H009 -011	
		BF-DNGM150412TSWS2	★													12.7	4.76	1.2	2.6	5.16			
	NEW	BF-DNGM150408TAWS2	●													12.7	4.76	0.8	2.4	5.16			
		BF-DNGM150412TAWS2	●													12.7	4.76	1.2	2.6	5.16			
	(With Breaker)																						
	NEW PETIT CUT	BM-DNGM150404TA2	★	★												12.7	4.76	0.4	2.1	5.16	 EPSR 55° RE IC LE D1 S	C010 C011 E015 E038 -040 H009 -011	
		BM-DNGM150408TA2	★	★												12.7	4.76	0.8	2.0	5.16			
		BM-DNGM150412TA2	★	★												12.7	4.76	1.2	1.8	5.16			
		BM-DNGM150604TA2		●												12.7	6.35	0.4	2.1	5.16			
		BM-DNGM150608TA2		●												12.7	6.35	0.8	2.0	5.16			
	(With Breaker)	BM-DNGM150612TA2		●												12.7	6.35	1.2	1.8	5.16			

* Please refer to B024 before using wiper inserts.

● = NEW

● : Inventory maintained. ★ : Inventory maintained in Japan.

90° SN TYPE INSERTS WITH HOLE

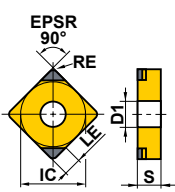
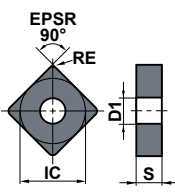
Work Material	H	Hardened Materials	● ● ● ● ● ● ✱	● ● ● ● ● ● ✱	● ● ● ● ● ● ✱	● ● ● ● ● ● ✱	Cutting Conditions (Guide) : ● : Stable Cutting ● : General Cutting ✱ : Unstable Cutting Honing (Last letter of order number) : Please refer to page B021					Geometry	Applicable Holder Page								
	K	Cast Iron																			
Shape	Order Number	Coated PCBN			PCBN			Solid PCBN	Dimensions (mm)					Geometry	Applicable Holder Page						
		NEW BC8210	BC8220	BC8105	BC8110	BC8120	BC8130	NEW BC5110	NEW MB8110	MB8120	MB8130	MB4120	MB710			MB730	MBS140	IC	S	RE	LE
NEW PETIT CUT	NP-SNGA12040GS2										★				12.7	4.76	0.4	2.0	5.16	 C012 -015 E016 E037	
	NP-SNGA120408GS2						★				●	★	★		12.7	4.76	0.8	2.2	5.16		
	NP-SNGA120412GS2											★	★	★		12.7	4.76	1.2	2.5		5.16
	NP-SNGA120408GA2		●			●	★		★						12.7	4.76	0.8	2.2	5.16		
	NP-SNGA120412GA2		★				★	★		★					12.7	4.76	1.2	2.5	5.16		
	NP-SNGA120404FS2											★			12.7	4.76	0.4	2.0	5.16		
	NP-SNGA120408FS2											●			12.7	4.76	0.8	2.2	5.16		
	NP-SNGA120412FS2											●			12.7	4.76	1.2	2.5	5.16		
	NP-SNGA120404TS2											★			12.7	4.76	0.4	2.0	5.16		
	NP-SNGA120408TS2											★			12.7	4.76	0.8	2.2	5.16		
	NP-SNGA120412TS2											★			12.7	4.76	1.2	2.5	5.16		
	NP-SNGA120404SF2											★			12.7	4.76	0.4	2.0	5.16		
	NP-SNGA120408SF2											★			12.7	4.76	0.8	2.2	5.16		
	NP-SNGA120412SF2											★			12.7	4.76	1.2	2.5	5.16		
	NP-SNGA120404SE2											★			12.7	4.76	0.4	2.0	5.16		
	NP-SNGA120408SE2											★			12.7	4.76	0.8	2.2	5.16		
NP-SNGA120412SE2											★			12.7	4.76	1.2	2.5	5.16			
	SNGA120408											★		12.7	4.76	0.8	—	5.16	 C012 -015 E016 E037		
	SNGA120412											★		12.7	4.76	1.2	—	5.16			

● = NEW

PCBN

B

PCBN TURNING INSERTS

NEG

WITH HOLE

C

D

R

S

T

V

W



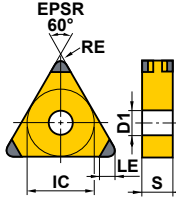
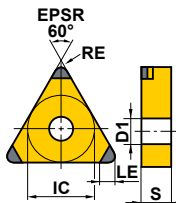

PCBN TURNING INSERTS [NEGATIVE]

60° TN TYPE INSERTS WITH HOLE

Work Material	H	Hardened Materials											Cutting Conditions (Guide) :					Geometry	Applicable Holder Page																				
	K	Cast Iron											● : Stable Cutting ● : General Cutting ✦ : Unstable Cutting																										
	S	Heat-resistant Alloy, Titanium Alloy											Honing (Last letter of order number) : Please refer to page B021																										
Shape	Order Number	Coated PCBN					PCBN					Solid PCBN					Dimensions (mm)																						
		NEW BC8210	BC8220	BC8105	BC8110	BC8120	BC8130	NEW BC5110	NEW MB8110	NEW MB8120	NEW MB8130	MB4120	MB710	MB730	MBS140	IC	S	RE	LE	D1																			
PCBN	B	PCBN TURNING INSERTS	NEG	WITH HOLE	C	D	R	S	T	V	W	NEW PETIT CUT	NP-TNGA160404GS6	●	●	●												9.525	4.76	0.4	1.6	3.81	 C016 -018 E016 E037						
												NP-TNGA160408GS6	●	●	●																	9.525		4.76	0.8	1.7	3.81		
												NP-TNGA160412GS6	●	●	●																			9.525	4.76	1.2	1.9	3.81	
												NP-TNGA160404GA6	●		●	●				★														9.525	4.76	0.4	1.6	3.81	
												NP-TNGA160408GA6	●		●	●				★														9.525	4.76	0.8	1.7	3.81	
												NP-TNGA160412GA6	●		●	●				★														9.525	4.76	1.2	1.9	3.81	
												NP-TNGA160404GH6	★		★	★	★																	9.525	4.76	0.4	1.6	3.81	
												NP-TNGA160408GH6	★		★	★	★																	9.525	4.76	0.8	1.7	3.81	
												NP-TNGA160412GH6	★		★	★	★																	9.525	4.76	1.2	1.9	3.81	
												NEW NP-TNGA160404VA6	★																					9.525	4.76	0.4	1.6	3.81	
												NEW NP-TNGA160408VA6	★																					9.525	4.76	0.8	1.7	3.81	
												NEW NP-TNGA160412VA6	★																					9.525	4.76	1.2	1.9	3.81	
												NP-TNGA160404FS6	★		●	★	★			★														9.525	4.76	0.4	1.6	3.81	
												NP-TNGA160408FS6	★		●	★	★			★														9.525	4.76	0.8	1.7	3.81	
												NP-TNGA160412FS6	★		●	★	★			★														9.525	4.76	1.2	1.9	3.81	
												NP-TNGA160404TS6	★			★																		9.525	4.76	0.4	1.6	3.81	
												NP-TNGA160408TS6	★			★																		9.525	4.76	0.8	1.7	3.81	
												NP-TNGA160412TS6	★			★																		9.525	4.76	1.2	1.9	3.81	
												NP-TNGA160404TA6	★			★	●			★	★													9.525	4.76	0.4	1.6	3.81	
												NP-TNGA160408TA6	★			★	●			★	★													9.525	4.76	0.8	1.7	3.81	
												NP-TNGA160412TA6	★			★	●			★	★													9.525	4.76	1.2	1.9	3.81	
												NP-TNGA160404TH6				★	★				★													9.525	4.76	0.4	1.6	3.81	
												NP-TNGA160408TH6	★			★	●			★														9.525	4.76	0.8	1.7	3.81	
												NP-TNGA160412TH6	★			★	●			★														9.525	4.76	1.2	1.9	3.81	
												NEW PETIT CUT	NP-TNGA160402GS3	★			★																	9.525	4.76	0.2	1.5	3.81	 C016 -018 E016 E037
												NP-TNGA160404GS3	★		●	★			★			★												9.525	4.76	0.4	1.6	3.81	
												NP-TNGA160408GS3	★		●	★			★			●	★	●										9.525	4.76	0.8	1.7	3.81	
NP-TNGA160412GS3	★		●	★			★			★	★	★									9.525	4.76	1.2	1.9	3.81														
NP-TNGA160402GA3	★			★					★												9.525	4.76	0.2	1.5	3.81														
NP-TNGA160404GA3	●			●	●			★													9.525	4.76	0.4	1.6	3.81														
NP-TNGA160408GA3	●			●	●			●													9.525	4.76	0.8	1.7	3.81														
NP-TNGA160412GA3	★			★	●			★													9.525	4.76	1.2	1.9	3.81														
NP-TNGA160404GH3	★			★	★	●															9.525	4.76	0.4	1.6	3.81														
NP-TNGA160408GH3	★			★	★	●															9.525	4.76	0.8	1.7	3.81														
NP-TNGA160412GH3	★			★	★	●															9.525	4.76	1.2	1.9	3.81														
NEW NP-TNGA160404VA3	★																				9.525	4.76	0.4	1.6	3.81														
NEW NP-TNGA160408VA3	●																				9.525	4.76	0.8	1.7	3.81														
NEW NP-TNGA160412VA3	★																				9.525	4.76	1.2	1.9	3.81														
NP-TNGA160402FS3	★			★				★													9.525	4.76	0.2	1.5	3.81														
NP-TNGA160404FS3	●		●	●	●			★	★			●									9.525	4.76	0.4	1.6	3.81														
NP-TNGA160408FS3	●		●	●	●			★	★			★									9.525	4.76	0.8	1.7	3.81														
NP-TNGA160412FS3	●		●	●	●			★	★			★									9.525	4.76	1.2	1.9	3.81														

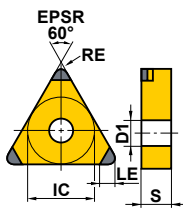
● = NEW

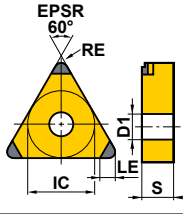
● : Inventory maintained. ★ : Inventory maintained in Japan.

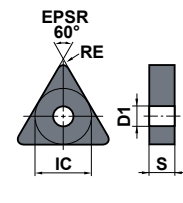
Work Material	H	Hardened Materials	Cutting Conditions (Guide) :												Dimensions (mm)	Geometry	Applicable Holder Page					
	K	Cast Iron	● : Stable Cutting ● : General Cutting ✖ : Unstable Cutting																			
	S	Heat-resistant Alloy, Titanium Alloy	Honing (Last letter of order number) : Please refer to page B021																			
		Sintered Alloy	Coated PCBN			PCBN			Solid PCBN													
Shape	Order Number	NEW BC8210	BC8220	BC8105	BC8110	BC8120	BC8130	NEW BC5110	NEW MB8110	MB8120	MB8130	MB4120	MB710	MB730	MBS140	IC	S	RE	LE	D1		
NEW PETIT CUT 	NP-TNGA160404TS3	●		●								★				9.525	4.76	0.4	1.6	3.81		C016 -018 E016 E037
	NP-TNGA160408TS3	●		●								★				9.525	4.76	0.8	1.7	3.81		
	NP-TNGA160412TS3	●		●									★			9.525	4.76	1.2	1.9	3.81		
	NP-TNGA160404TA3	●			●	●			●	●						9.525	4.76	0.4	1.6	3.81		
	NP-TNGA160408TA3	●			●	●			●	★						9.525	4.76	0.8	1.7	3.81		
	NP-TNGA160412TA3	●			●	●			●	★						9.525	4.76	1.2	1.9	3.81		
	NP-TNGA160404TH3					★	★			★						9.525	4.76	0.4	1.6	3.81		
	NP-TNGA160408TH3	★			★	★				★						9.525	4.76	0.8	1.7	3.81		
	NP-TNGA160412TH3	★			★	★				★						9.525	4.76	1.2	1.9	3.81		
	NP-TNGA160404SF3												★			9.525	4.76	0.4	1.6	3.81		
	NP-TNGA160408SF3												★			9.525	4.76	0.8	1.7	3.81		
	NP-TNGA160412SF3												★			9.525	4.76	1.2	1.9	3.81		
	NP-TNGA160404SE3												★			9.525	4.76	0.4	1.6	3.81		
	NP-TNGA160408SE3												★			9.525	4.76	0.8	1.7	3.81		
NP-TNGA160412SE3												★			9.525	4.76	1.2	1.9	3.81			
NEW PETIT CUT 	BM-TNGM160408TA3				●											9.525	4.76	0.8	1.7	3.81		C016 -018 E016 E037
	BM-TNGM160412TA3				●											9.525	4.76	1.2	1.9	3.81		
(With Breaker) 	TNGA160408												★		9.525	4.76	0.8	-	3.81		C016 -018 E016 E037	
	TNGA160412												★		9.525	4.76	1.2	-	3.81			

● = NEW

PCBN

B

PCBN TURNING INSERTS

NEG

WITH HOLE

C

D

R

S

T

V

W

GRADES > B004
IDENTIFICATION > B002

B045

PCBN TURNING INSERTS [NEGATIVE]

35° VN TYPE INSERTS WITH HOLE

PCBN

B

PCBN TURNING INSERTS

NEG

WITH HOLE

C

D

R

S

T

V

W

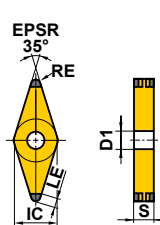
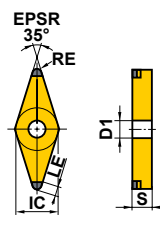
Work Material	H	Hardened Materials												Cutting Conditions (Guide) :					Geometry	Applicable Holder Page
	K	Cast Iron												● : Stable Cutting ● : General Cutting ✱ : Unstable Cutting						
	S	Heat-resistant Alloy, Titanium Alloy												Honing (Last letter of order number) : Please refer to page B021						
Shape	Order Number	Coated PCBN					PCBN					Solid PCBN	Dimensions (mm)							
		NEW BC8210	BC8220	BC8105	BC8110	BC8120	NEW BC8130	NEW MB8110	NEW MB8120	MB8130	MB4120	MB710	MB730	MBS140	IC	S	RE			LE
NEW PETIT CUT	NP-VNGA16040GS4	★	●	★											9.525	4.76	0.4	2.5	3.81	 C019 -021 E017
	NP-VNGA160408GS4	●	●	●											9.525	4.76	0.8	2.0	3.81	
	NP-VNGA160412GS4	★		★											9.525	4.76	1.2	1.5	3.81	
	NP-VNGA160404GA4	●	●	●	●	●	★								9.525	4.76	0.4	2.5	3.81	
	NP-VNGA160408GA4	●	●	●	●	●	★								9.525	4.76	0.8	2.0	3.81	
	NP-VNGA160412GA4	●	●	●	●	●	★								9.525	4.76	1.2	1.5	3.81	
	NP-VNGA160404GH4	★		★	★	★									9.525	4.76	0.4	2.5	3.81	
	NP-VNGA160408GH4	★		★	★	★									9.525	4.76	0.8	2.0	3.81	
	NP-VNGA160412GH4			★	★	★									9.525	4.76	1.2	1.5	3.81	
	NEW NP-VNGA160404VA4	★													9.525	4.76	0.4	2.5	3.81	
	NEW NP-VNGA160408VA4	★													9.525	4.76	0.8	2.0	3.81	
	NEW NP-VNGA160412VA4	★													9.525	4.76	1.2	1.5	3.81	
	NP-VNGA160404FS4	★	●	★	★		★								9.525	4.76	0.4	2.5	3.81	
	NP-VNGA160408FS4	★	●	★	★		★								9.525	4.76	0.8	2.0	3.81	
	NP-VNGA160412FS4			★											9.525	4.76	1.2	1.5	3.81	
	NP-VNGA160404TS4	★		★											9.525	4.76	0.4	2.5	3.81	
	NP-VNGA160408TS4	★		★											9.525	4.76	0.8	2.0	3.81	
	NP-VNGA160404TA4	★		★	●		★								9.525	4.76	0.4	2.5	3.81	
	NP-VNGA160408TA4	★		★	●		★								9.525	4.76	0.8	2.0	3.81	
	NP-VNGA160412TA4			★	●		★								9.525	4.76	1.2	1.5	3.81	
NP-VNGA160404TH4	★		★	★										9.525	4.76	0.4	2.5	3.81		
NP-VNGA160408TH4	★		★	★										9.525	4.76	0.8	2.0	3.81		
NP-VNGA160412TH4			★	★										9.525	4.76	1.2	1.5	3.81		
NEW PETIT CUT	NP-VNGA160402GS2	★		★											9.525	4.76	0.2	2.5	3.81	 C019 -021 E017
	NP-VNGA160404GS2	●	●	●		★			★						9.525	4.76	0.4	2.5	3.81	
	NP-VNGA160408GS2	●	●	●		★			★						9.525	4.76	0.8	2.0	3.81	
	NP-VNGA160412GS2	★		★											9.525	4.76	1.2	1.5	3.81	
	NP-VNGA160402GA2	●	●	●			★								9.525	4.76	0.2	2.5	3.81	
	NP-VNGA160404GA2	●	●	●	●	●	★								9.525	4.76	0.4	2.5	3.81	
	NP-VNGA160408GA2	●	●	●	●	●	★								9.525	4.76	0.8	2.0	3.81	
	NP-VNGA160412GA2	★		★	★		★								9.525	4.76	1.2	1.5	3.81	
	NP-VNGA160404GH2	★		★	★	★									9.525	4.76	0.4	2.5	3.81	
	NP-VNGA160408GH2	★		★	★	★									9.525	4.76	0.8	2.0	3.81	
	NP-VNGA160412GH2			★	★	★									9.525	4.76	1.2	1.5	3.81	
	NEW NP-VNGA160404VA2	●													9.525	4.76	0.4	2.5	3.81	
	NEW NP-VNGA160408VA2	●													9.525	4.76	0.8	2.0	3.81	
	NEW NP-VNGA160412VA2	★													9.525	4.76	1.2	1.5	3.81	
	NP-VNGA160402FS2	★		★			★								9.525	4.76	0.2	2.5	3.81	
NP-VNGA160404FS2	★	●	★	●		★	★		★					9.525	4.76	0.4	2.5	3.81		
NP-VNGA160408FS2	★	●	★	●		★	★		●					9.525	4.76	0.8	2.0	3.81		
NP-VNGA160412FS2			★											9.525	4.76	1.2	1.5	3.81		

● = NEW

● : Inventory maintained. ★ : Inventory maintained in Japan.

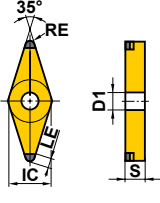
Work Material	H	Hardened Materials															Cutting Conditions (Guide) :				
	K	Cast Iron															● : Stable Cutting	● : General Cutting	✱ : Unstable Cutting		
	S	Heat-resistant Alloy, Titanium Alloy															Honing (Last letter of order number) :				
		Sintered Alloy															Please refer to page B021				
Shape	Order Number	Coated PCBN				PCBN				Solid PCBN	Dimensions (mm)					Geometry	Applicable Holder Page				
		NEW BC8210	BC8220	BC8105	BC8110	BC8120	BC8130	NEW BC5110	NEW MB8110	MB8120	MB8130	MB4120	MB710	MB730	MBS140			IC	S	RE	LE
NEW PETIT CUT 	NP-VNGA160404TS2	★			★						★				9.525	4.76	0.4	2.5	3.81		C019 -021 E017
	NP-VNGA160408TS2	★			★						★				9.525	4.76	0.8	2.0	3.81		
	NP-VNGA160404TA2		●				● ●				●				9.525	4.76	0.4	2.5	3.81		
	NP-VNGA160408TA2		●				● ●				★				9.525	4.76	0.8	2.0	3.81		
	NP-VNGA160412TA2						★ ★				★				9.525	4.76	1.2	1.5	3.81		
	NP-VNGA160404TH2		★				★ ★								9.525	4.76	0.4	2.5	3.81		
	NP-VNGA160408TH2		★				★ ★								9.525	4.76	0.8	2.0	3.81		
	NP-VNGA160412TH2						★ ★								9.525	4.76	1.2	1.5	3.81		
	NP-VNGA160404SF2											★			9.525	4.76	0.4	2.5	3.81		
	NP-VNGA160408SF2											★			9.525	4.76	0.8	2.0	3.81		
	NP-VNGA160404SE2											★			9.525	4.76	0.4	2.5	3.81		
	NP-VNGA160408SE2											★			9.525	4.76	0.8	2.0	3.81		

● = NEW

PCBN

B

PCBN TURNING INSERTS

NEG

WITH HOLE

C

D

R

S

T

V

W

PCBN TURNING INSERTS [NEGATIVE]

80° WN TYPE INSERTS WITH HOLE

PCBN

B

PCBN TURNING INSERTS

NEG

WITH HOLE

C

D





R

S

T

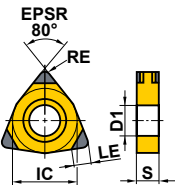
V

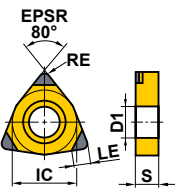
W

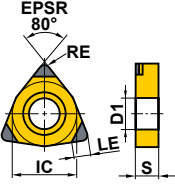
Work Material	H	Hardened Materials											Cutting Conditions (Guide) :					Geometry	Applicable Holder Page		
	K	Cast Iron											● : Stable Cutting ● : General Cutting ✱ : Unstable Cutting								
Shape	Order Number	Coated PCBN					PCBN					Solid PCBN	Dimensions (mm)					Geometry	Applicable Holder Page		
		NEW BC8210	BC8220	BC8105	BC8110	BC8120	BC8130	NEW BC5110	NEW MB8110	MB8120	MB8130	MB4120	MB710	MB730	MBS140	IC	S			RE	LE
NEW PETIT CUT 	NP-WNGA080408GS6	●		★	●										12.7	4.76	0.8	2.0	5.16		C022 C023 E017
	NP-WNGA080408FS6	★		★	★										12.7	4.76	0.8	2.0	5.16		
	NP-WNGA080408TS6	★			★										12.7	4.76	0.8	2.0	5.16		
NEW PETIT CUT 	NP-WNGA080408GS3	★		★	★					★					12.7	4.76	0.8	2.0	5.16		C022 C023 E017
	NP-WNGA080408GA3	★	★		★	★									12.7	4.76	0.8	2.0	5.16		
	NP-WNGA080408GH3			★	★	★									12.7	4.76	0.8	2.0	5.16		
	NP-WNGA080408FS3	★		★	★	★				★					12.7	4.76	0.8	2.0	5.16		
	NP-WNGA080408TS3	★		★						★					12.7	4.76	0.8	2.0	5.16		
	NP-WNGA080408TA3	★	★		★	★									12.7	4.76	0.8	2.0	5.16		
	NP-WNGA080408TH3			★	★										12.7	4.76	0.8	2.0	5.16		
	NP-WNGA080408SF3										★				12.7	4.76	0.8	2.0	5.16		
NP-WNGA080408SE3										★				12.7	4.76	0.8	2.0	5.16			
NEW PETIT CUT (With Wiper) * 	NP-WNGA080408GSWS3	●			●										12.7	4.76	0.8	2.0	5.16		C022 C023 E017

* Please refer to B024 before using wiper inserts.

● = NEW

● : Inventory maintained. ★ : Inventory maintained in Japan.

80° CN TYPE INSERTS WITHOUT HOLE

Work Material	H	Hardened Materials	● ● ● ● ● ● ✱	● ● ● ✱	● ● ● ● ✱	● ● ● ● ✱	Cutting Conditions (Guide) : ● : Stable Cutting ● : General Cutting ✱ : Unstable Cutting					Geometry	Applicable Holder Page								
	K	Cast Iron							IC	S	RE			LE							
Shape	S	Heat-resistant Alloy, Titanium Alloy						Dimensions (mm)				Geometry	Applicable Holder Page								
		Sintered Alloy																			
		Coated PCBN	PCBN			Solid PCBN															
		NEW BC8210	NEW BC8220	BC8105	BC8110	BC8120	BC8130	NEW BC5110	NEW MB8110	NEW MB8120	MB8130	MB4120	MB710	MB730	MBS140	IC	S	RE	LE	Geometry	Applicable Holder Page
	CNGN120404														●	12.7	4.76	0.4	—		—
	CNGN120408														●	12.7	4.76	0.8	—		
	CNGN120412														●	12.7	4.76	1.2	—		

● = NEW

55° DN TYPE INSERTS WITHOUT HOLE

Work Material	H	Hardened Materials	● ● ● ● ● ● ✱	● ● ● ✱	● ● ● ● ✱	● ● ● ● ✱	Cutting Conditions (Guide) : ● : Stable Cutting ● : General Cutting ✱ : Unstable Cutting					Geometry	Applicable Holder Page								
	K	Cast Iron							IC	S	RE			LE							
Shape	S	Heat-resistant Alloy, Titanium Alloy						Dimensions (mm)				Geometry	Applicable Holder Page								
		Sintered Alloy																			
		Coated PCBN	PCBN			Solid PCBN															
		NEW BC8210	NEW BC8220	BC8105	BC8110	BC8120	BC8130	NEW BC5110	NEW MB8110	NEW MB8120	MB8130	MB4120	MB710	MB730	MBS140	IC	S	RE	LE	Geometry	Applicable Holder Page
	DNGN110308														★	9.525	3.18	0.8	—		—
	DNGN110312														★	9.525	3.18	1.2	—		

● = NEW

RN TYPE INSERTS WITHOUT HOLE

Work Material	H	Hardened Materials	● ● ● ● ● ● ✱	● ● ● ✱	● ● ● ● ✱	● ● ● ● ✱	Cutting Conditions (Guide) : ● : Stable Cutting ● : General Cutting ✱ : Unstable Cutting					Geometry	Applicable Holder Page								
	K	Cast Iron							IC	S	RE			LE							
Shape	S	Heat-resistant Alloy, Titanium Alloy						Dimensions (mm)				Geometry	Applicable Holder Page								
		Sintered Alloy																			
		Coated PCBN	PCBN			Solid PCBN															
		NEW BC8210	NEW BC8220	BC8105	BC8110	BC8120	BC8130	NEW BC5110	NEW MB8110	NEW MB8120	MB8130	MB4120	MB710	MB730	MBS140	IC	S	RE	LE	Geometry	Applicable Holder Page
	RNGN090300														●	9.525	3.18	—	—		—
	RNGN120300														●	12.7	3.18	—	—		
	RNGN120400														●	12.7	4.76	—	—		

● = NEW

PCBN TURNING INSERTS [NEGATIVE]

90° SN TYPE INSERTS WITHOUT HOLE

PCBN

B

PCBN TURNING INSERTS

NEG

WITHOUT HOLE

C

D

R

S

T

V

W

Work Material	H	Hardened Materials											Cutting Conditions (Guide) :				Geometry	Applicable Holder Page			
	K	Cast Iron											● : Stable Cutting ● : General Cutting ✖ : Unstable Cutting								
Shape	Order Number	Coated PCBN					PCBN					Solid PCBN	Dimensions (mm)				IC	S	RE	LE	
		BC8210	BC8220	BC8105	BC8110	BC8120	BC8130	BC5110	MB8110	MB8120	MB8130	MB4120	MB710	MB730	MBS140						
	SNGN090308														●	9.525	3.18	0.8	—		—
	SNGN090312														●	9.525	3.18	1.2	—		
	SNGN090316														●	9.525	3.18	1.6	—		
	SNGN090408														★	9.525	4.76	0.8	—		
	SNGN090412														★	9.525	4.76	1.2	—		
	SNGN120408														●	12.7	4.76	0.8	—		
	SNGN120412														●	12.7	4.76	1.2	—		
	SNGN120416														●	12.7	4.76	1.6	—		

● = NEW

60° TN TYPE INSERTS WITHOUT HOLE

Work Material	H	Hardened Materials											Cutting Conditions (Guide) :				Geometry	Applicable Holder Page			
	K	Cast Iron											● : Stable Cutting ● : General Cutting ✖ : Unstable Cutting								
Shape	Order Number	Coated PCBN					PCBN					Solid PCBN	Dimensions (mm)				IC	S	RE	LE	
		BC8210	BC8220	BC8105	BC8110	BC8120	BC8130	BC5110	MB8110	MB8120	MB8130	MB4120	MB710	MB730	MBS140						
	TNGN160408														●	9.525	4.76	0.8	—		—
	TNGN160412														●	9.525	4.76	1.2	—		
	TNGN160416														●	9.525	4.76	1.6	—		

● = NEW

● : Inventory maintained. ★ : Inventory maintained in Japan.

□ : Non stock, produced to order only.

PCBN TURNING INSERTS [POSITIVE]

80° CC TYPE INSERTS WITH HOLE

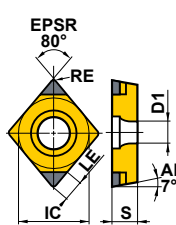
Work Material	H	Hardened Materials	Cutting Conditions (Guide) :										Geometry	Applicable Holder Page								
	K	Cast Iron	● : Stable Cutting ● : General Cutting ✖ : Unstable Cutting																			
Shape	S	Heat-resistant Alloy, Titanium Alloy	Coated PCBN					PCBN					Dimensions (mm)					IC	S	RE	LE	D1
		Sintered Alloy	NEW BC8210	BC8220	BC8105	BC8110	BC8120	BC8130	NEW BC5110	NEW MB8110	MB8120	MB8130	MB4120	MB710	MB730							
NEW PETIT CUT	NP-CCGW060202GS2	★	★	★				●				★	★	★	6.35	2.38	0.2	1.7	2.8		C024 D010 E007 E008 E032 E036	
	NP-CCGW060204GS2	●	●	●								●	●	★	6.35	2.38	0.4	1.8	2.8			
	NP-CCGW060208GS2	●	●	●									★	●	★	6.35	2.38	0.8	2.0			2.8
	NP-CCGW09T302GS2	★	★	★									★			9.525	3.97	0.2	1.7			4.4
	NP-CCGW09T304GS2	●	●	●				★					★	●	●	9.525	3.97	0.4	1.8			4.4
	NP-CCGW09T308GS2	●	●	●				★					★	●	●	9.525	3.97	0.8	2.0			4.4
	NP-CCGW060202GA2		●		●				●							6.35	2.38	0.2	1.7			2.8
	NP-CCGW060204GA2		●		●	●			●					●		6.35	2.38	0.4	1.8			2.8
	NP-CCGW060208GA2		●		●	●			●							6.35	2.38	0.8	2.0			2.8
	NP-CCGW09T302GA2		●		●				●							9.525	3.97	0.2	1.7			4.4
	NP-CCGW09T304GA2		●		●	●			●					●		9.525	3.97	0.4	1.8			4.4
	NP-CCGW09T308GA2		●		●	●			●							9.525	3.97	0.8	2.0			4.4
	NP-CCGW09T304GH2			★	★	●										9.525	3.97	0.4	1.8			4.4
	NP-CCGW09T308GH2			★	★	●										9.525	3.97	0.8	2.0			4.4
	NEW NP-CCGW09T304VA2		●													9.525	3.97	0.4	1.8			4.4
	NEW NP-CCGW09T308VA2		●													9.525	3.97	0.8	2.0			4.4
	NP-CCGW060202FS2	●		●		●	●		●	●			●	●		6.35	2.38	0.2	1.7			2.8
	NP-CCGW060204FS2	●		●		●	●		●	●			●	●		6.35	2.38	0.4	1.8			2.8
	NP-CCGW060208FS2	●		●		●	●		●	●			●	□		6.35	2.38	0.8	2.0			2.8
	NP-CCGW09T302FS2	●	★	●		●	●		●	★			★			9.525	3.97	0.2	1.7			4.4
	NP-CCGW09T304FS2	●	●	●	●	●	●		●	●	●		●	●	●	9.525	3.97	0.4	1.8			4.4
	NP-CCGW09T308FS2	●	●	●	●	●	●		●	●	●		●	●	□	9.525	3.97	0.8	2.0			4.4
	NP-CCGW060202FA2												●			6.35	2.38	0.2	1.7			2.8
	NP-CCGW060204FA2												●			6.35	2.38	0.4	1.8			2.8
	NP-CCGW060208FA2												●			6.35	2.38	0.8	2.0			2.8
	NP-CCGW060208TS2													★		6.35	2.38	0.8	2.0			2.8
	NP-CCGW09T308TS2													★		9.525	3.97	0.8	2.0			4.4
	NP-CCGW060204TA2					●				★						6.35	2.38	0.4	1.8			2.8
	NP-CCGW060208TA2					●				★						6.35	2.38	0.8	2.0			2.8
	NP-CCGW09T304TA2	●		●	●				★	★						9.525	3.97	0.4	1.8			4.4
	NP-CCGW09T308TA2	●		●	●				★	★						9.525	3.97	0.8	2.0			4.4
	NP-CCGW09T304TH2			★	●					★						9.525	3.97	0.4	1.8			4.4
	NP-CCGW09T308TH2			★	●					★						9.525	3.97	0.8	2.0			4.4
	NP-CCGW060202SF2												★			6.35	2.38	0.2	1.7			2.8
	NP-CCGW060204SF2												●			6.35	2.38	0.4	1.8			2.8
NP-CCGW060208SF2												★			6.35	2.38	0.8	2.0	2.8			
NP-CCGW09T302SF2												★			9.525	3.97	0.2	1.7	4.4			
NP-CCGW09T304SF2												●			9.525	3.97	0.4	1.8	4.4			
NP-CCGW09T308SF2												●			9.525	3.97	0.8	2.0	4.4			
NP-CCGW060202SE2												★			6.35	2.38	0.2	1.7	2.8			
NP-CCGW060204SE2												●			6.35	2.38	0.4	1.8	2.8			
NP-CCGW060208SE2												★			6.35	2.38	0.8	2.0	2.8			
NP-CCGW09T302SE2												★			9.525	3.97	0.2	1.7	4.4			

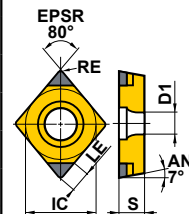

C024
D010
E007
E008
E032
E036

● = NEW

PCBN TURNING INSERTS [POSITIVE]

80° CC TYPE INSERTS WITH HOLE

Work Material	H	Hardened Materials		●	●	●	●	●	●	●	●	●	Cutting Conditions (Guide) :					Geometry	Applicable Holder Page
	K	Cast Iron										●	●	●	● : Stable Cutting ● : General Cutting ✖ : Unstable Cutting				
	S	Heat-resistant Alloy, Titanium Alloy											●	●	Honing (Last letter of order number) : Please refer to page B021				
Shape	Order Number	Coated PCBN			PCBN			Dimensions (mm)					Geometry	Applicable Holder Page					
		NEW BC8210 BC8220	BC8105 BC8110 BC8120 BC8130	NEW BC5110	NEW MB8110 MB8120 MB8130	MB4120 MB710 MB730	IC	S	RE	LE	D1								
PCBN	NEW PETIT CUT	NP-CCGW09T304SE2						★			9.525	3.97	0.4	1.8	4.4		C024 D010 E007 E008 E032 E036		
		NP-CCGW09T308SE2						●			9.525	3.97	0.8	2.0	4.4				
B	NEW PETIT CUT (With Wiper) *1	NP-CCGW09T304GSWS2	●	●	●						9.525	3.97	0.4	1.8	4.4		C024 D010 E032 E036		
		NP-CCGW09T308GSWS2	●	●	●						9.525	3.97	0.8	2.0	4.4				
		NP-CCGW09T304GWS2	●	●	●		★				9.525	3.97	0.4	1.8	4.4				
		NP-CCGW09T308GWS2	●	●	●		★				9.525	3.97	0.8	2.0	4.4				
		NP-CCGW09T304GBWL2		★	★	★			★		9.525	3.97	0.4	1.8	4.4				
		NP-CCGW09T308GBWL2		★	★	★			★		9.525	3.97	0.8	2.0	4.4				
		NP-CCGW09T304FSWS2	●	●	★	★			★		9.525	3.97	0.4	1.8	4.4				
		NP-CCGW09T308FSWS2	●	●	★	★			★		9.525	3.97	0.8	2.0	4.4				
		NP-CCGW09T304FBWL2		★	★	★			★		9.525	3.97	0.4	1.8	4.4				
NP-CCGW09T308FBWL2		★	★	★			★		9.525	3.97	0.8	2.0	4.4						
7°	NEW PETIT CUT	BF-CCGT09T304TS2	●		●						9.525	3.97	0.4	1.8	4.4		C024 D010 E032 E036		
		BF-CCGT09T308TS2	●		●					9.525	3.97	0.8	2.0	4.4					
C	NEW PETIT CUT	BM-CCGT09T304TA2	●		●						9.525	3.97	0.4	1.8	4.4		C024 D010 E032 E036		
		BM-CCGT09T308TA2	●		●					9.525	3.97	0.8	2.0	4.4					
WITH HOLE	NEW PETIT CUT	* NP-CCGW03S102GS			●						3.57	1.39	0.2	1.1	2.0		E018		
		* NP-CCGW03S104GS			●					3.57	1.39	0.4	1.0	2.0					
		* NP-CCGW04T002GS			●					4.37	1.79	0.2	1.5	2.4					
		* NP-CCGW04T004GS			●					4.37	1.79	0.4	1.4	2.4					
		* NP-CCGW03S102FS	●		●		★			3.57	1.39	0.2	1.1	2.0					
		* NP-CCGW03S104FS	●		●		●			3.57	1.39	0.4	1.0	2.0					
		* NP-CCGW04T002FS	●		●		●			4.37	1.79	0.2	1.5	2.4					
		* NP-CCGW04T004FS	●		●		●			4.37	1.79	0.4	1.4	2.4					

*1 Please refer to B024 before using wiper inserts.

* Diameter of inscribed circle is non-ISO standard. (For SCLC type)

● = NEW

● : Inventory maintained. ★ : Inventory maintained in Japan.

80° CP TYPE INSERTS WITH HOLE

Work Material	H	Hardened Materials											Cutting Conditions (Guide) :					Geometry	Applicable Holder Page			
	K	Cast Iron											● : Stable Cutting ● : General Cutting ✖ : Unstable Cutting									
	S	Heat-resistant Alloy, Titanium Alloy											Honing (Last letter of order number) : Please refer to page B021									
		Sintered Alloy	Coated PCBN					PCBN					Dimensions (mm)									
Shape	Order Number		NEW BC8210	BC8220	BC8105	BC8110	BC8120	BC8130	NEW BC5110	NEW MB8110	MB8120	MB8130	MB4120	MB710	MB730	IC	S	RE	LE	D1		
NEW PETIT CUT	NP-CPGB080204GS2	★ ● ★													7.94	2.38	0.4	1.8	3.5			
	NP-CPGB080208GS2	★ ● ★													7.94	2.38	0.8	2.0	3.5			
	NP-CPGB090302GS2	★ ★ ★													9.525	3.18	0.2	1.7	4.5			
	NP-CPGB090304GS2	★ ● ★													9.525	3.18	0.4	1.8	4.5			
	NP-CPGB090308GS2	★ ● ★													9.525	3.18	0.8	2.0	4.5			
	NP-CPGB080204GA2	● ● ●													7.94	2.38	0.4	1.8	3.5			
	NP-CPGB080208GA2	● ● ●													7.94	2.38	0.8	2.0	3.5			
	NP-CPGB080212GA2	★ ★ ★													7.94	2.38	1.2	2.2	3.5			
	NP-CPGB090302GA2	★ ★													9.525	3.18	0.2	1.7	4.5			
	NP-CPGB090304GA2	● ● ●													9.525	3.18	0.4	1.8	4.5			
	NP-CPGB090308GA2	● ● ●													9.525	3.18	0.8	2.0	4.5			
	NP-CPGB090312GA2	★ ★ ★													9.525	3.18	1.2	2.2	4.5			
	NEW NP-CPGB090304VA2	●													9.525	3.18	0.4	1.8	4.5			
	NEW NP-CPGB090308VA2	●													9.525	3.18	0.8	2.0	4.5			
	NEW NP-CPGB090312VA2	★													9.525	3.18	1.2	2.2	4.5			
	NP-CPGB080202FS2												★		7.94	2.38	0.2	1.7	3.5			
	NP-CPGB080204FS2		★										●		7.94	2.38	0.4	1.8	3.5			
	NP-CPGB080208FS2		★												7.94	2.38	0.8	2.0	3.5			
	NP-CPGB090302FS2		★ ★										★		9.525	3.18	0.2	1.7	4.5			
	NP-CPGB090304FS2		● ★										★		9.525	3.18	0.4	1.8	4.5			
	NP-CPGB090308FS2		● ★										★		9.525	3.18	0.8	2.0	4.5			
	NP-CPGB090312FS2		★												9.525	3.18	1.2	2.2	4.5			
	NP-CPGB080204TA2						★								7.94	2.38	0.4	1.8	3.5			
	NP-CPGB080208TA2						★								7.94	2.38	0.8	2.0	3.5			
	NP-CPGB080212TA2						★								7.94	2.38	1.2	2.2	3.5			
	NP-CPGB090304TA2		★ ★ ★												9.525	3.18	0.4	1.8	4.5			
	NP-CPGB090308TA2		★ ★ ★												9.525	3.18	0.8	2.0	4.5			
	NP-CPGB090312TA2		★ ★ ★												9.525	3.18	1.2	2.2	4.5			
	NP-CPGB080202SE2												★		7.94	2.38	0.2	1.7	3.5			
	NP-CPGB080204SE2												★		7.94	2.38	0.4	1.8	3.5			
	NP-CPGB090302SE2												★		9.525	3.18	0.2	1.7	4.5			
	NP-CPGB090304SE2												★		9.525	3.18	0.4	1.8	4.5			
NP-CPGB090308SE2												★		9.525	3.18	0.8	2.0	4.5				

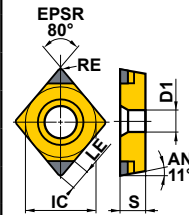

E007
E008

● = NEW

PCBN

B

PCBN TURNING INSERTS

POSI 11°

WITH HOLE

C

D

R

S

T

V

W



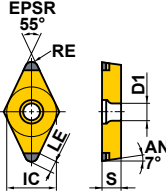

PCBN TURNING INSERTS [POSITIVE]

55° DC TYPE INSERTS WITH HOLE

Work Material	H	Hardened Materials											Cutting Conditions (Guide) :					Geometry	Applicable Holder Page		
	K	Cast Iron											● : Stable Cutting ● : General Cutting ✱ : Unstable Cutting								
	S	Heat-resistant Alloy, Titanium Alloy											Honing (Last letter of order number) : Please refer to page B021								
Shape	Order Number	Coated PCBN					PCBN					Dimensions (mm)					Geometry	Applicable Holder Page			
		NEW BC8210	BC8220	BC8105	BC8110	BC8120	BC8130	NEW BC5110	NEW MB8110	MB8120	MB8130	MB4120	MB710	MB730	IC	S			RE	LE	D1
NEW PETIT CUT	NP-DCGW070202GS2	●	●	●											6.35	2.38	0.2	2.2	2.8		C025 D011 D026 E010 E011 E031 E033
	NP-DCGW070204GS2	●	●	●			★				●				6.35	2.38	0.4	2.1	2.8		
	NP-DCGW070208GS2	●	●	●							★				6.35	2.38	0.8	2.0	2.8		
	NP-DCGW11T302GS2	●	●	●							★				9.525	3.97	0.2	2.2	4.4		
	NP-DCGW11T304GS2	●	●	●		●					●				9.525	3.97	0.4	2.1	4.4		
	NP-DCGW11T304GS2										●	●			9.525	3.97	0.4	1.5	4.4		
	NP-DCGW11T308GS2	●	●	●		●					●				9.525	3.97	0.8	2.0	4.4		
	NP-DCGW11T308GS2										●	●			9.525	3.97	0.8	1.7	4.4		
	NP-DCGW070202GA2	●			●					●					6.35	2.38	0.2	2.2	2.8		
	NP-DCGW070204GA2	●			●	●				●					6.35	2.38	0.4	2.1	2.8		
	NP-DCGW070208GA2	★			●										6.35	2.38	0.8	2.0	2.8		
	NP-DCGW11T302GA2	●			●					●					9.525	3.97	0.2	2.2	4.4		
	NP-DCGW11T304GA2	●			●	●				●					9.525	3.97	0.4	2.1	4.4		
	NP-DCGW11T308GA2	●			●	●				●					9.525	3.97	0.8	2.0	4.4		
	NP-DCGW11T304GH2				★	★	●								9.525	3.97	0.4	2.1	4.4		
	NP-DCGW11T308GH2				★	★	●								9.525	3.97	0.8	2.0	4.4		
	NEW NP-DCGW11T304VA2	●													9.525	3.97	0.4	2.1	4.4		
	NEW NP-DCGW11T308VA2	●													9.525	3.97	0.8	2.0	4.4		
	NP-DCGW070202FS2	●		●					●						6.35	2.38	0.2	2.2	2.8		
	NP-DCGW070204FS2	●		●	●	●		●	●		●	●			6.35	2.38	0.4	2.1	2.8		
	NP-DCGW070208FS2	★		★				★			●				6.35	2.38	0.8	2.0	2.8		
	NP-DCGW11T302FS2	●	●	●						●	●				9.525	3.97	0.2	2.2	4.4		
	NP-DCGW11T304FS2	●	●	●	●					●	●				9.525	3.97	0.4	2.1	4.4		
	NP-DCGW11T308FS2	●	●	●	●	★	●			●					9.525	3.97	0.8	2.0	4.4		
	NP-DCGW11T304FA2										★	●			9.525	3.97	0.4	1.5	4.4		
	NP-DCGW11T308FA2										●	●			9.525	3.97	0.8	1.7	4.4		
	NP-DCGW070204TA2			●	●				●	●					6.35	2.38	0.4	2.1	2.8		
	NP-DCGW070208TA2			●						★					6.35	2.38	0.8	2.0	2.8		
NP-DCGW11T304TA2	★		★	●			★	●						9.525	3.97	0.4	2.1	4.4			
NP-DCGW11T308TA2	★		★	●			★	●						9.525	3.97	0.8	2.0	4.4			
NP-DCGW11T304TH2			★	●				●						9.525	3.97	0.4	2.1	4.4			
NP-DCGW11T308TH2			★	●				●						9.525	3.97	0.8	2.0	4.4			
NP-DCGW070204SF2										●				6.35	2.38	0.4	2.1	2.8			
NP-DCGW070208SF2										●				6.35	2.38	0.8	2.0	2.8			
NP-DCGW11T302SF2										★				9.525	3.97	0.2	2.2	4.4			
NP-DCGW11T304SF2										●				9.525	3.97	0.4	2.1	4.4			
NP-DCGW11T308SF2										●				9.525	3.97	0.8	2.0	4.4			

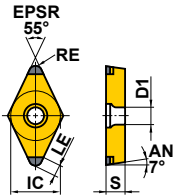
● = NEW

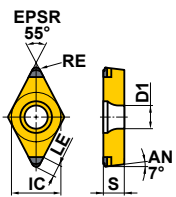
● : Inventory maintained. ★ : Inventory maintained in Japan.

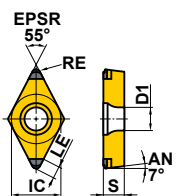
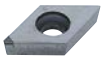
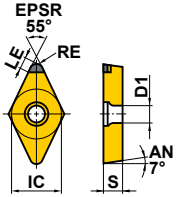
Work Material	H	Hardened Materials											Cutting Conditions (Guide) :											
	K	Cast Iron											● : Stable Cutting ● : General Cutting ✖ : Unstable Cutting											
Shape	S	Heat-resistant Alloy, Titanium Alloy	Coated PCBN					PCBN					Dimensions (mm)					Geometry	Applicable Holder Page					
		Sintered Alloy	BC8210	BC8220	BC8105	BC8110	BC8120	BC8130	BC5110	MB8110	MB8120	MB8130	MB4120	MB710	MB730	IC	S			RE	LE	D1		
NEW PETIT CUT 	NP-DCGW070204SE2																				 EPSR 55° RE IC LE AN 17° S D1	C025 D011 D026 E010 E011 E031 E033		
	NP-DCGW070208SE2												★											
	NP-DCGW11T302SE2																							
	NP-DCGW11T304SE2																							
	NP-DCGW11T308SE2																							
NEW PETIT CUT 	BF-DCGT11T304TS2	●		●																	 EPSR 55° RE IC LE AN 17° S D1	C025 D011 D026 E010 E011 E031 E033		
	BF-DCGT11T308TS2	●		●																				
(With Breaker)																								
NEW PETIT CUT 	BM-DCGT11T304TA2	●		●																	 EPSR 55° RE IC LE AN 17° S D1	C025 D011 D026 E010 E011 E031 E033		
	BM-DCGT11T308TA2	●		●																				
(With Breaker)																								
NEW PETIT CUT 	NP-DCGW11T302GS												★ ★								 EPSR 55° RE IC LE AN 17° S D1	C025 D011 D026 E010 E011 E031 E033		

● = NEW

PCBN

B

PCBN TURNING INSERTS

POSI 7°

WITH HOLE

C

D

R

S

T

V

W

PCBN TURNING INSERTS [POSITIVE]

60° TC TYPE INSERTS WITH HOLE

PCBN

B

PCBN TURNING INSERTS

POSITIVE
7°

WITH HOLE

C

D

R

S

T

V

W

Work Material	H	Hardened Materials	● ○ ● ○ ● ○ ● ✖						● ○ ● ○ ● ✖			● ○ ● ○ ●			Cutting Conditions (Guide) : ● : Stable Cutting ● : General Cutting ✖ : Unstable Cutting Honing (Last letter of order number) : Please refer to page B021					Geometry	Applicable Holder Page
	K	Cast Iron																			
	S	Heat-resistant Alloy, Titanium Alloy																			
Shape	Order Number	Coated PCBN					PCBN					Dimensions (mm)									
		NEW BC8210	BC8220	BC8105	BC8110	BC8120	BC8130	NEW BC5110	NEW MB8110	MB8120	MB8130	MB4120	MB710	MB730	IC	S			RE	LE	D1
	NEW PETIT CUT	NP-TCGW090204GS3			★			★							5.56	2.38	0.4	1.6	2.5		C029 E030
		NP-TCGW090208GS3			★										5.56	2.38	0.8	1.7	2.5		
		NP-TCGW110202GS3			★										6.35	2.38	0.2	1.5	2.8		
		NP-TCGW110204GS3			★						★				6.35	2.38	0.4	1.6	2.8		
		NP-TCGW110208GS3			★				★		★				6.35	2.38	0.8	1.7	2.8		
		NP-TCGW130304GS3			★										7.94	3.18	0.4	1.6	3.4		
		NP-TCGW130308GS3			★										7.94	3.18	0.8	1.7	3.4		
		NP-TCGW16T304GS3			★						□ □				9.525	3.97	0.4	1.6	4.4		
		NP-TCGW16T308GS3			★						□ ●				9.525	3.97	0.8	1.7	4.4		
		NP-TCGW110204FS3							★		●				6.35	2.38	0.4	1.6	2.8		
		NP-TCGW110208FS3							★		●				6.35	2.38	0.8	1.7	2.8		
		NP-TCGW16T304FS3									□ □				9.525	3.97	0.4	1.6	4.4		
		NP-TCGW16T308FS3									□ □				9.525	3.97	0.8	1.7	4.4		
		NP-TCGW110204SF3											★		6.35	2.38	0.4	1.6	2.8		
		NP-TCGW110208SF3											★		6.35	2.38	0.8	1.7	2.8		
	NP-TCGW110204SE3											★		6.35	2.38	0.4	1.6	2.8			
	NP-TCGW110208SE3											★		6.35	2.38	0.8	1.7	2.8			
	NEW PETIT CUT	NP-TCGW090204GS										● □		5.56	2.38	0.4	1.6	2.5		C029 E030	
		NP-TCGW090208GS										□ □		5.56	2.38	0.8	1.7	2.5			
		NP-TCGW110204GS										● ●		6.35	2.38	0.4	1.6	2.8			
		NP-TCGW110208GS										● □		6.35	2.38	0.8	1.7	2.8			
		NP-TCGW090204FS										● ●		5.56	2.38	0.4	1.6	2.5			
		NP-TCGW090208FS										□ □		5.56	2.38	0.8	1.7	2.5			
		NP-TCGW110204FS										● ●		6.35	2.38	0.4	1.6	2.8			
		NP-TCGW110208FS										□ □		6.35	2.38	0.8	1.7	2.8			

● = NEW

● : Inventory maintained. ★ : Inventory maintained in Japan.
□ : Non stock, produced to order only.

60° TP TYPE INSERTS WITH HOLE

Work Material	H	Hardened Materials											Cutting Conditions (Guide) :					Geometry	Applicable Holder Page		
	K	Cast Iron											● : Stable Cutting ● : General Cutting ✖ : Unstable Cutting								
	S	Heat-resistant Alloy, Titanium Alloy											Honing (Last letter of order number) :								
Shape	Order Number	Coated PCBN					PCBN					Dimensions (mm)					Geometry	Applicable Holder Page			
		NEW BC8210	BC8220	BC8105	BC8110	BC8120	BC8130	NEW BC5110	NEW MB8110	MB8120	MB8130	MB4120	MB710	MB730	IC	S			RE	LE	D1
												● : Stable Cutting ● : General Cutting ✖ : Unstable Cutting							Honing (Last letter of order number) :		
NEW PETIT CUT	NP-TPGB080204GS3	★	★	★		★								4.76	2.38	0.4	1.6	2.4	E009		
	NP-TPGB080208GS3	★	★	★										4.76	2.38	0.8	1.7	2.4			
	NP-TPGB090202GS3										★			5.56	2.38	0.2	1.5	2.9			
	NP-TPGB090204GS3	★	★	★							★			5.56	2.38	0.4	1.6	2.9			
	NP-TPGB090208GS3	★	★	★										5.56	2.38	0.8	1.7	2.9			
	NP-TPGB110302GS3	★	★	★							★			6.35	3.18	0.2	1.5	3.4			
	NP-TPGB110304GS3	★	★	★		★					★			6.35	3.18	0.4	1.6	3.4			
	NP-TPGB110308GS3	★	★	★		★					★			6.35	3.18	0.8	1.7	3.4			
	NP-TPGB160304GS3	★	★	★										9.525	3.18	0.4	1.6	4.4			
	NP-TPGB160308GS3	★	★	★										9.525	3.18	0.8	1.7	4.4			
	NP-TPGB080204GA3													4.76	2.38	0.4	1.6	2.4			
	NP-TPGB080208GA3													4.76	2.38	0.8	1.7	2.4			
	NP-TPGB090204GA3		★			★	●			●				5.56	2.38	0.4	1.6	2.9			
	NP-TPGB090208GA3		★			★	●			★				5.56	2.38	0.8	1.7	2.9			
	NP-TPGB110302GA3		★			★				★				6.35	3.18	0.2	1.5	3.4			
	NP-TPGB110304GA3		●			●	●			●				6.35	3.18	0.4	1.6	3.4			
	NP-TPGB110308GA3		●			●	●			●				6.35	3.18	0.8	1.7	3.4			
	NP-TPGB160304GA3		●			●	★			★				9.525	3.18	0.4	1.6	4.4			
	NP-TPGB160308GA3		●			●	★			★				9.525	3.18	0.8	1.7	4.4			
	NP-TPGB160304GH3					★	★	★						9.525	3.18	0.4	1.6	4.4			
	NP-TPGB160308GH3					★	★	★						9.525	3.18	0.8	1.7	4.4			
	NEW NP-TPGB110304VA3		●											6.35	3.18	0.4	1.6	3.4			
	NEW NP-TPGB110308VA3		●											6.35	3.18	0.8	1.7	3.4			
	NP-TPGB090202FS3										★			5.56	2.38	0.2	1.5	2.9			
	NP-TPGB090204FS3										★			5.56	2.38	0.4	1.6	2.9			
	NP-TPGB110302FS3	★	★	★						★	★			6.35	3.18	0.2	1.5	3.4			
	NP-TPGB110304FS3	★	★	★	●		★	●		★				6.35	3.18	0.4	1.6	3.4			
	NP-TPGB110308FS3	★	★	★	●		★	●		★				6.35	3.18	0.8	1.7	3.4			
	NP-TPGB160304FS3					●								9.525	3.18	0.4	1.6	4.4			
	NP-TPGB160308FS3					●								9.525	3.18	0.8	1.7	4.4			
	NP-TPGB080204TA3						★				●			4.76	2.38	0.4	1.6	2.4			
	NP-TPGB080208TA3						★				★			4.76	2.38	0.8	1.7	2.4			
	NP-TPGB090204TA3						★				●			5.56	2.38	0.4	1.6	2.9			
	NP-TPGB090208TA3						★				★			5.56	2.38	0.8	1.7	2.9			
	NP-TPGB110304TA3		★			★	●			●	●			6.35	3.18	0.4	1.6	3.4			
	NP-TPGB110308TA3		★			★	★			★	★			6.35	3.18	0.8	1.7	3.4			
	NP-TPGB160304TA3					★	●			★	★			9.525	3.18	0.4	1.6	4.4			
	NP-TPGB160308TA3					★	●			★	★			9.525	3.18	0.8	1.7	4.4			
	NP-TPGB160304TH3					★	★			★				9.525	3.18	0.4	1.6	4.4			
	NP-TPGB160308TH3					★	★			★				9.525	3.18	0.8	1.7	4.4			

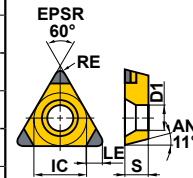

E009

PCBN

B

PCBN TURNING INSERTS

POSI 11°

WITH HOLE

C

D

R

S

T

V

W

● = NEW

GRADES > B004
IDENTIFICATION > B002

B057

PCBN TURNING INSERTS [POSITIVE]

60° TP TYPE INSERTS WITH HOLE

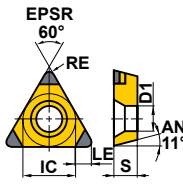
Work Material	H	Hardened Materials	Cutting Conditions (Guide) :										Honing (Last letter of order number) :									
	K	Cast Iron	● : Stable Cutting ● : General Cutting ✖ : Unstable Cutting											Please refer to page B021								
Shape	S	Heat-resistant Alloy, Titanium Alloy	Coated PCBN					PCBN					Dimensions (mm)					Geometry	Applicable Holder Page			
		Sintered Alloy	NEW	NEW	NEW	NEW	NEW	NEW	NEW	NEW	NEW	IC	S	RE	LE	D1						
			BC8210	BC8220	BC8105	BC8110	BC8120	BC8130	BC5110	MB8110	MB8120	MB8130	MB4120	MB710	MB730							
NEW PETIT CUT 	NP-TPGB090202SF3												*			5.56	2.38	0.2	1.5	2.9	 <p>E009</p>	
	NP-TPGB090204SF3												*			5.56	2.38	0.4	1.6	2.9		
	NP-TPGB110302SF3												*			6.35	3.18	0.2	1.5	3.4		
	NP-TPGB110304SF3												*			6.35	3.18	0.4	1.6	3.4		
	NP-TPGB110308SF3												*			6.35	3.18	0.8	1.7	3.4		
	NP-TPGB090202SE3												*			5.56	2.38	0.2	1.5	2.9		
	NP-TPGB090204SE3												*			5.56	2.38	0.4	1.6	2.9		
	NP-TPGB110302SE3												*			6.35	3.18	0.2	1.5	3.4		
	NP-TPGB110304SE3												*			6.35	3.18	0.4	1.6	3.4		
	NP-TPGB110308SE3												*			6.35	3.18	0.8	1.7	3.4		

● = NEW

PCBN

B

PCBN TURNING INSERTS

POS 11°

WITH HOLE

C

D

R

S

T

V

W

● : Inventory maintained. ★ : Inventory maintained in Japan.

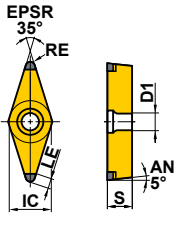

35° VB TYPE INSERTS WITH HOLE

Work Material	H	Hardened Materials	● ○ ● ○ ● ○ ● ○ ● ○		● ○ ● ○ ● ○ ● ○ ● ○		● ● ● ● ● ● ● ● ● ● ● ●		Cutting Conditions (Guide) :					Geometry	Applicable Holder Page				
	K	Cast Iron							●	: Stable Cutting	○	: General Cutting	✱			: Unstable Cutting			
	S	Heat-resistant Alloy, Titanium Alloy							○	Honing (Last letter of order number) :									
		Sintered Alloy							○	Please refer to page B021									
Shape	Order Number	Coated PCBN					PCBN					Dimensions (mm)					Geometry	Applicable Holder Page	
		NEW BC8210	BC8220	BC8105	BC8110	BC8120	BC8130	NEW BC5110	NEW MB8110	MB8120	MB8130	MB4120	MB710	MB730	IC	S			RE
NEW PETIT CUT	NP-VBGW110302GS2	★	★	★									6.35	3.18	0.2	2.5	2.85		
	NP-VBGW110304GS2	★	★	★							★		6.35	3.18	0.4	2.5	2.85		
	NP-VBGW110304GS2										★		6.35	3.18	0.4	1.3	2.85		
	NP-VBGW110308GS2	★	★	★							★		6.35	3.18	0.8	2.0	2.85		
	NP-VBGW110308GS2										★		6.35	3.18	0.8	1.4	2.85		
	NP-VBGW160402GS2	●	★	●									9.525	4.76	0.2	2.5	4.43		
	NP-VBGW160404GS2	●	●	●	★						●		9.525	4.76	0.4	2.5	4.43		
	NP-VBGW160404GS2										★	●	9.525	4.76	0.4	1.3	4.43		
	NP-VBGW160408GS2	●	●	●	★						●		9.525	4.76	0.8	2.0	4.43		
	NP-VBGW160408GS2										★	●	9.525	4.76	0.8	1.4	4.43		
	NP-VBGW110302GA2	●		●		★							6.35	3.18	0.2	2.5	2.85		
	NP-VBGW110304GA2	●		●	●	★							6.35	3.18	0.4	2.5	2.85		
	NP-VBGW110308GA2	★		★	★	★							6.35	3.18	0.8	2.0	2.85		
	NP-VBGW160402GA2	★		★		★							9.525	4.76	0.2	2.5	4.43		
	NP-VBGW160404GA2	●		●	●	★							9.525	4.76	0.4	2.5	4.43		
	NP-VBGW160408GA2	●		●	●	★							9.525	4.76	0.8	2.0	4.43		
	NP-VBGW160404GH2			★	★	★							9.525	4.76	0.4	2.5	4.43		
	NP-VBGW160408GH2			★	★	●							9.525	4.76	0.8	2.0	4.43		
	NEW NP-VBGW160404VA2	●											9.525	4.76	0.4	2.5	4.43		
	NEW NP-VBGW160408VA2	●											9.525	4.76	0.8	2.0	4.43		
	NP-VBGW110302FS2	●		●		★							6.35	3.18	0.2	2.5	2.85		
	NP-VBGW110304FS2	★		★		★					★		6.35	3.18	0.4	2.5	2.85		
	NP-VBGW110308FS2	★		★		★					★		6.35	3.18	0.8	2.0	2.85		
	NP-VBGW160402FS2	★		★		★							9.525	4.76	0.2	2.5	4.43		
	NP-VBGW160404FS2			●							●		9.525	4.76	0.4	2.5	4.43		
	NP-VBGW160408FS2			●							●		9.525	4.76	0.8	2.0	4.43		
	NP-VBGW110304TA2					★							6.35	3.18	0.4	2.5	2.85		
	NP-VBGW110308TA2					★							6.35	3.18	0.8	2.0	2.85		
	NP-VBGW160404TA2	●		●	★		★						9.525	4.76	0.4	2.5	4.43		
	NP-VBGW160408TA2	★		★	★		★						9.525	4.76	0.8	2.0	4.43		
	NP-VBGW160404TH2			★	★								9.525	4.76	0.4	2.5	4.43		
	NP-VBGW160408TH2			★	★								9.525	4.76	0.8	2.0	4.43		
	NP-VBGW110304SF2										★		6.35	3.18	0.4	2.5	2.85		
	NP-VBGW110308SF2										★		6.35	3.18	0.8	2.0	2.85		
	NP-VBGW160404SF2										●		9.525	4.76	0.4	2.5	4.43		
	NP-VBGW160408SF2										★		9.525	4.76	0.8	2.0	4.43		
	NP-VBGW110304SE2										★		6.35	3.18	0.4	2.5	2.85		
	NP-VBGW110308SE2										★		6.35	3.18	0.8	2.0	2.85		
	NP-VBGW160404SE2										●		9.525	4.76	0.4	2.5	4.43		
	NP-VBGW160408SE2										★		9.525	4.76	0.8	2.0	4.43		

● = NEW

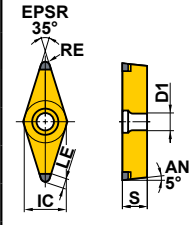

PCBN

B

PCBN TURNING INSERTS

POSI 5°

WITH HOLE

C

D

R

S

T

V

W

D012
D013
E013
E014
H013

PCBN TURNING INSERTS [POSITIVE]

35° VC TYPE INSERTS WITH HOLE

PCBN

B

PCBN TURNING INSERTS

POSI
7°

WITH HOLE

C

D

R

S

T

V

W

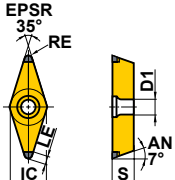
Work Material	H	Hardened Materials											Cutting Conditions (Guide) :					Geometry	Applicable Holder Page		
	K	Cast Iron											● : Stable Cutting ● : General Cutting ✖ : Unstable Cutting								
	S	Heat-resistant Alloy, Titanium Alloy											Honing (Last letter of order number) : Please refer to page B021								
	Sintered Alloy	Coated PCBN					PCBN					Dimensions (mm)									
Shape	Order Number	NEW BC8210	BC8220	BC8105	BC8110	BC8120	BC8130	NEW BC5110	NEW MB8110	MB8120	MB8130	MB4120	MB710	MB730	IC	S	RE	LE	D1		
NEW PETIT CUT 	NP-VCGW160404GS2	●	●	●										9.525	4.76	0.4	2.5	4.4	 EPSR 35° RE IC LE S AN 7°	C030 C031 E034 E035	
	NP-VCGW160408GS2	●		●	●									9.525	4.76	0.8	2.0	4.4			
	NP-VCGW160404GA2	●					●	●						9.525	4.76	0.4	2.5	4.4			
	NP-VCGW160408GA2	●					●	●						9.525	4.76	0.8	2.0	4.4			
	NP-VCGW160404GH2								★	★	★			9.525	4.76	0.4	2.5	4.4			
	NP-VCGW160408GH2								★	★	★			9.525	4.76	0.8	2.0	4.4			
	NEW NP-VCGW160404VA2	●												9.525	4.76	0.4	2.5	4.4			
	NEW NP-VCGW160408VA2	●												9.525	4.76	0.8	2.0	4.4			
	NP-VCGW160404FS2								●	●		★		9.525	4.76	0.4	2.5	4.4			
	NP-VCGW160408FS2								●	●		★		9.525	4.76	0.8	2.0	4.4			
	NP-VCGW160404TS2								★					9.525	4.76	0.4	2.5	4.4			
	NP-VCGW160408TS2								★					9.525	4.76	0.8	2.0	4.4			
	NP-VCGW160404TA2						★				★	★		9.525	4.76	0.4	2.5	4.4			
	NP-VCGW160408TA2						★				★	★		9.525	4.76	0.8	2.0	4.4			
	NP-VCGW160404TH2										★	★		9.525	4.76	0.4	2.5	4.4			
NP-VCGW160408TH2										★	★		9.525	4.76	0.8	2.0	4.4				

● = NEW

80° WC TYPE INSERTS WITH HOLE

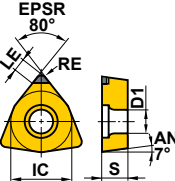
Work Material	H	Hardened Materials											Cutting Conditions (Guide) :					Geometry	Applicable Holder Page		
	K	Cast Iron											● : Stable Cutting ● : General Cutting ✖ : Unstable Cutting								
	S	Heat-resistant Alloy, Titanium Alloy											Honing (Last letter of order number) : Please refer to page B021								
	Sintered Alloy	Coated PCBN					PCBN					Dimensions (mm)									
Shape	Order Number	NEW BC8210	BC8220	BC8105	BC8110	BC8120	BC8130	NEW BC5110	NEW MB8110	MB8120	MB8130	MB4120	MB710	MB730	IC	S	RE	LE	D1		
NEW PETIT CUT 	NP-WCMWL30204FA													★	4.76	2.38	0.4	1.8	2.3	 EPSR 80° RE LE IC S AN 7°	E029
	NP-WCMWL30208FA													★	4.76	2.38	0.8	1.9	2.3		

● = NEW

● : Inventory maintained. ★ : Inventory maintained in Japan.

90° SP TYPE INSERTS WITHOUT HOLE

Work Material	H	Hardened Materials	Cutting Conditions (Guide) :												Geometry	Applicable Holder Page				
	K	Cast Iron	● : Stable Cutting ● : General Cutting ✖ : Unstable Cutting																	
	S	Heat-resistant Alloy, Titanium Alloy																		
	Sintered Alloy																			
Shape	Order Number	Coated PCBN						PCBN						Dimensions (mm)				Geometry	Applicable Holder Page	
		BC8210	BC8220	BC8105	BC8110	BC8120	BC8130	NEW BC5110	NEW MB8110	NEW MB8120	MB8130	MB4120	MB710	MB730	IC	S	RE			LE
NEW PETIT CUT NEW	NP-SPGN120412GS2							★							12.7	4.76	1.2	2.5		-
	SPGN090304												★	9.525	3.18	0.4	4.0		-	
	SPGN090308												★	9.525	3.18	0.8	4.1			
	SPGN120304												★ ★	12.7	3.18	0.4	4.0			
	SPGN120308												★ ★	12.7	3.18	0.8	4.1			

● = NEW

PCBN

B

PCBN TURNING INSERTS

POSI 11°

WITHOUT HOLE

C

D

R

S

T

V

W

GY TYPE INSERTS WITHOUT HOLE

Work Material	H	Hardened Materials	Cutting Conditions (Guide):												Geometry	Applicable Holder Page								
	K	Cast Iron	● : Stable Cutting ● : General Cutting ✳ : Unstable Cutting																					
	S	Heat-resistant Alloy, Titanium Alloy																						
		Sintered Alloy	Coated PCBN				PCBN				Dimensions (mm)													
Shape		Order Number		NEW BC8210	BC8220	BC8105	BC8110	BC8120	BC8130	NEW BC5110	NEW MB8110	NEW MB8120	MB8130	MB4120	MB710	MB730	CW	RER REL	L	LE	ANR ANL			
			GY1G0200D020N-GFGS			●										2.00	0.2	20.7	2.7	3°				
			GY1G0239E020N-GFGS			●										2.39	0.2	20.7	2.7	7°				
			GY1G0250E020N-GFGS			●										2.5	0.2	20.7	2.7	7°				
			GY1G0300F020N-GFGS			●										3.00	0.2	20.7	2.7	7°				
			GY1G0318F020N-GFGS			●										3.18	0.2	20.7	2.7	7°				
			GY1G0400G020N-GFGS			●										4.00	0.2	25.65	2.7	7°				
			GY1G0475H020N-GFGS			●										4.75	0.2	25.65	2.7	7°				
			GY1G0500H020N-GFGS			●										5.00	0.2	25.65	2.7	7°				
			GY1G0600J020N-GFGS			●										6.00	0.2	25.65	2.7	7°				

● = NEW

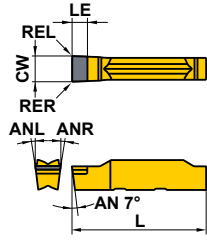

PCBN

B

PCBN TURNING INSERTS

F018-093

POSI 7°

WITHOUT HOLE

C

D

R

S

T

V



W

GRADES > B004
IDENTIFICATION > B002

B063

PCD TURNING INSERTS [NEGATIVE]

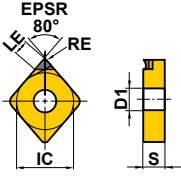
80° CN TYPE INSERTS WITH HOLE

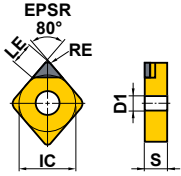
Work Material	N	Non-ferrous Metal	●	Cutting Conditions (Guide) :					
				● : Stable Cutting	● : General Cutting	✖ : Unstable Cutting			
Shape	Order Number	PCD	Dimensions (mm)					Geometry	Applicable Holder Page
		MD220	IC	S	RE	LE	D1		
 (With Breaker)	NP-CNMM120402R-F	★	12.7	4.76	0.2	1.7	5.16	 Right hand insert shown.	C008 C009 E015 E038 H006 -008
	NP-CNMM120404R-F	★	12.7	4.76	0.4	1.8	5.16		
	NP-CNMM120408R-F	★	12.7	4.76	0.8	2.0	5.16		
	CNMA120404	★	12.7	4.76	0.4	3.6	5.16	 Right hand insert shown.	C008 C009 E015 E038 H006 -008
	CNMA120408	★	12.7	4.76	0.8	3.6	5.16		

PCD

B

PCD TURNING INSERTS

NEG

WITH HOLE

C

D

R



S

T

V

W

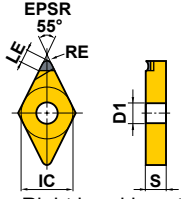
55° DN TYPE INSERTS WITH HOLE

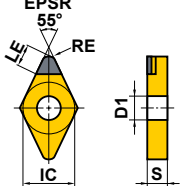
Work Material	N	Non-ferrous Metal	●	Cutting Conditions (Guide) :					
				● : Stable Cutting	● : General Cutting	✖ : Unstable Cutting			
Shape	Order Number	PCD	Dimensions (mm)					Geometry	Applicable Holder Page
		MD220	IC	S	RE	LE	D1		
 (With Breaker)	NP-DNMM150402R-F	★	12.7	4.76	0.2	2.2	5.16	 Right hand insert shown.	C010 C011 E015 E038 -040 H009 H010
	NP-DNMM150404R-F	★	12.7	4.76	0.4	2.1	5.16		
	NP-DNMM150408R-F	★	12.7	4.76	0.8	2.0	5.16		
	DNMA150404	★	12.7	4.76	0.4	2.9	5.16	 Right hand insert shown.	C010 C011 E015 E038 -040 H009 H010
	DNMA150408	★	12.7	4.76	0.8	2.4	5.16		

★ : Inventory maintained in Japan.

90° SN TYPE INSERTS WITH HOLE

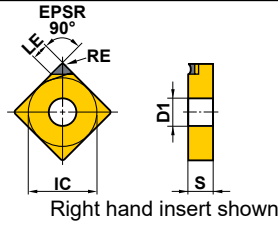

Work Material	N	Non-ferrous Metal	●	Cutting Conditions (Guide) :					
				● : Stable Cutting	● : General Cutting	✖ : Unstable Cutting			
Shape	Order Number	PCD	Dimensions (mm)					Geometry	Applicable Holder Page
		MD220	IC	S	RE	LE	D1		
NEW PETIT CUT  (With Breaker)	NP-SNMM120404R-F	★	12.7	4.76	0.4	2.0	5.16		C012 -015 E016 E037
	NP-SNMM120408R-F	★	12.7	4.76	0.8	2.2	5.16		

PCD

B

PCD TURNING INSERTS

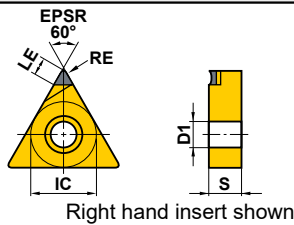
60° TN TYPE INSERTS WITH HOLE

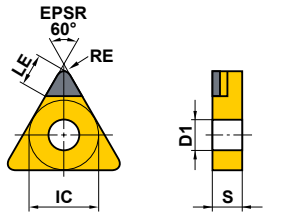
Work Material	N	Non-ferrous Metal	●	Cutting Conditions (Guide) :					
				● : Stable Cutting	● : General Cutting	✖ : Unstable Cutting			
Shape	Order Number	PCD	Dimensions (mm)					Geometry	Applicable Holder Page
		MD220	IC	S	RE	LE	D1		
NEW PETIT CUT  (With Breaker)	NP-TNMM160402R-F	★	9.525	4.76	0.2	1.5	3.81		C016 -018 E016 E037
	NP-TNMM160404R-F	★	9.525	4.76	0.4	1.6	3.81		
	NP-TNMM160408R-F	★	9.525	4.76	0.8	1.7	3.81		
	TNGA160402	★	9.525	4.76	0.2	3.1	3.81		C016 -018 E016 E037
	TNGA160404	★	9.525	4.76	0.4	2.9	3.81		
	TNGA160408	★	9.525	4.76	0.8	2.8	3.81		

NEG

WITH HOLE

C

D

R

S

T

V

W

GRADES > B028
IDENTIFICATION > B002

B065

PCD TURNING INSERTS [NEGATIVE]







35° VN TYPE INSERTS WITH HOLE

Work Material	N	Non-ferrous Metal	●	Cutting Conditions (Guide) :						
				● : Stable Cutting	● : General Cutting	✦ : Unstable Cutting				
Shape	Order Number	PCD	Dimensions (mm)					Geometry	Applicable Holder Page	
		MD220	IC	S	RE	LE	D1			
PCD B PCD TURNING INSERTS (With Breaker)	NEW PETIT CUT	NP-VNMM160402R-F	★	9.525	4.76	0.2	2.5	3.81	 EPSR 35° Right hand insert shown.	C019 -021 E017
		NP-VNMM160404R-F	★	9.525	4.76	0.4	2.5	3.81		
		NP-VNMM160408R-F	★	9.525	4.76	0.8	2.0	3.81		
NEG WITH HOLE C D R S T V W		VNGA160404	★	9.525	4.76	0.4	2.6	3.81	 EPSR 35°	C019 -021 E017
		VNGA160408	★	9.525	4.76	0.8	1.8	3.81		

● : Inventory maintained. ★ : Inventory maintained in Japan.

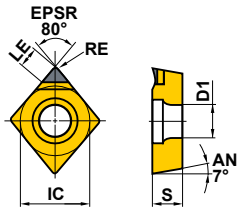

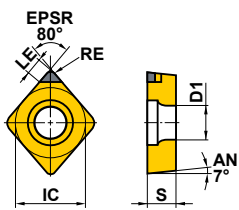
PCD TURNING INSERTS [POSITIVE]

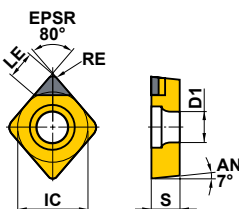
80° CC TYPE INSERTS WITH HOLE

Work Material	N	Non-ferrous Metal	●	Cutting Conditions (Guide) :					PCD	Dimensions (mm)					Geometry	Applicable Holder Page
				●	●	●	✦	IC		S	RE	LE	D1			
NEW PETIT CUT  (With Breaker)		NP-CCMH060202	★	●	●	●	●	6.35	2.38	0.2	1.7	2.8		C024 D010 E007 E008 E032 E036		
		NP-CCMH060204	★	●	●	●	●	6.35	2.38	0.4	1.8	2.8				
NEW PETIT CUT 	*	NP-CCMW03S102	●	●	●	●	3.57	1.39	0.2	1.1	2.0		E018			
	*	NP-CCMW03S104	★	●	●	●	3.57	1.39	0.4	1.0	2.0					
	*	NP-CCMW04T002	●	●	●	●	4.37	1.79	0.2	1.5	2.4					
	*	NP-CCMW04T004	★	●	●	●	4.37	1.79	0.4	1.4	2.4					
		CCMW060202	★	●	●	●	6.35	2.38	0.2	2.9	2.8		C024 D010 E007 E008 E032 E036			
		CCMW060204	★	●	●	●	6.35	2.38	0.4	2.9	2.8					
		CCMW09T302	★	●	●	●	9.525	3.97	0.2	3.3	4.4					
		CCMW09T304	★	●	●	●	9.525	3.97	0.4	3.3	4.4					

* Diameter of inscribed circle is special. (For SCLC type)

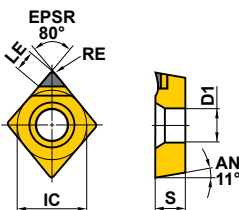
80° CP TYPE INSERTS WITH HOLE

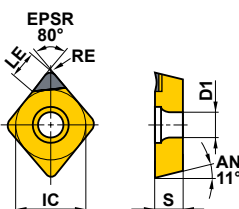
Work Material	N	Non-ferrous Metal	●	Cutting Conditions (Guide) :					PCD	Dimensions (mm)					Geometry	Applicable Holder Page
				●	●	●	✦	IC		S	RE	LE	D1			
NEW PETIT CUT  (With Breaker)		NP-CPMH080202	★	●	●	●	●	7.94	2.38	0.2	1.7	3.5		E007 E008		
		NP-CPMH080204	★	●	●	●	●	7.94	2.38	0.4	1.8	3.5				
		NP-CPMH090302	★	●	●	●	●	9.525	3.18	0.2	1.7	4.5				
		NP-CPMH090304	★	●	●	●	●	9.525	3.18	0.4	1.8	4.5				
 (With Breaker)		CPGT080202	★	●	●	●	●	7.94	2.38	0.2	3.7	3.4		-		
		CPGT080204	★	●	●	●	●	7.94	2.38	0.4	3.6	3.4				
		CPGT090302	★	●	●	●	●	9.525	3.18	0.2	3.3	4.4				
		CPGT090304	★	●	●	●	●	9.525	3.18	0.4	3.3	4.4				

PCD TURNING INSERTS [POSITIVE]

55° DC TYPE INSERTS WITH HOLE

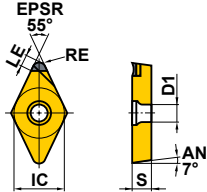
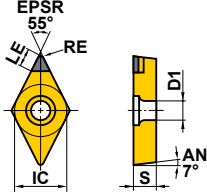

Work Material	N	Non-ferrous Metal	●	Cutting Conditions (Guide) :						
				● : Stable Cutting	● : General Cutting	✦ : Unstable Cutting				
Shape	Order Number	PCD	Dimensions (mm)					Geometry	Applicable Holder Page	
		MD220	IC	S	RE	LE	D1			
PCD B PCD TURNING INSERTS POSITIVE 7° 11° WITH HOLE	NEW PETIT CUT	NP-DCMT070202R-F	★	6.35	2.38	0.2	1.4	2.8	 Left hand insert shown.	C025 D011 D026 E010 E011 E031 E033
		NP-DCMT070202L-F	★	6.35	2.38	0.2	1.4	2.8		
		NP-DCMT070204R-F	★	6.35	2.38	0.4	1.5	2.8		
		NP-DCMT070204L-F	★	6.35	2.38	0.4	1.5	2.8		
		NP-DCMT11T302R-F	★	9.525	3.97	0.2	1.4	4.4		
		NP-DCMT11T302L-F	★	9.525	3.97	0.2	1.4	4.4		
		NP-DCMT11T304R-F	★	9.525	3.97	0.4	1.5	4.4		
	(With Breaker)	NP-DCMT11T304L-F	★	9.525	3.97	0.4	1.5	4.4		
	DCMW070202	★	6.35	2.38	0.2	2.7	2.8		C025 D011 D026 E010 E011 E031 E033	
	DCMW070204	★	6.35	2.38	0.4	2.5	2.8			
	DCMW11T302	★	9.525	3.97	0.2	3.0	4.4			
	DCMW11T304	★	9.525	3.97	0.4	2.9	4.4			

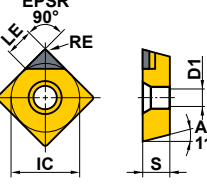
90° SP TYPE INSERTS WITH HOLE

Work Material	N	Non-ferrous Metal	●	Cutting Conditions (Guide) :						
				● : Stable Cutting	● : General Cutting	✦ : Unstable Cutting				
Shape	Order Number	PCD	Dimensions (mm)					Geometry	Applicable Holder Page	
		MD220	IC	S	RE	LE	D1			
S T V W		SPGX090304	★	9.525	3.18	0.4	3.7	4.8		-
		SPGX090308	★	9.525	3.18	0.8	3.8	4.8		

★ : Inventory maintained in Japan.

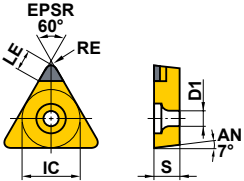
60° TC TYPE INSERTS WITH HOLE

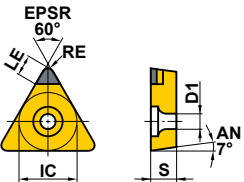
Work Material	N	Non-ferrous Metal	●	Cutting Conditions (Guide) :				PCD	Dimensions (mm)					Geometry	Applicable Holder Page
				● : Stable Cutting	● : General Cutting	✦ : Unstable Cutting	IC		S	RE	LE	D1			
	TCMW110202	★	6.35	2.38	0.2	2.7	2.8		C029 E030						
	TCMW110204	★	6.35	2.38	0.4	2.6	2.8								
	TCGW060102	★	3.97	1.59	0.2	1.5	2.3		-						
	TCGW060104	★	3.97	1.59	0.4	1.6	2.3								
	TCGW060108	★	3.97	1.59	0.8	1.4	2.3								

PCD

B

PCD TURNING INSERTS

POSI
7°

WITH
HOLE

C

D

R

S

T

V

W

PCD TURNING INSERTS [POSITIVE]

60° TP TYPE INSERTS WITH HOLE

PCD

B

PCD TURNING INSERTS

POSI 11°

WITH HOLE

C

D

R

S

T

V

W

Work Material	N	Non-ferrous Metal	●	Cutting Conditions (Guide) :					PCD	Dimensions (mm)					Geometry	Applicable Holder Page							
				● : Stable Cutting	● : General Cutting	✦ : Unstable Cutting	IC	S		RE	LE	D1											
NEW PETIT CUT	NP-TPMX090202R-F	★	5.56	2.38	0.2	1.5	3.0	MD220	IC	S	RE	LE	D1		E009 E027								
																NP-TPMX090202L-F	★	5.56	2.38	0.2	1.5	3.0	
																NP-TPMX090204L-F	★	5.56	2.38	0.4	1.6	3.0	
																NP-TPMX090208L-F	★	5.56	2.38	0.8	1.7	3.0	
																NP-TPMX110302L-F	★	6.35	3.18	0.2	1.5	3.5	
																NP-TPMX110304L-F	★	6.35	3.18	0.4	1.6	3.5	
																NP-TPMX110308L-F	★	6.35	3.18	0.8	1.7	3.5	
																NP-TPMX160302L-F	★	9.525	3.18	0.2	1.5	4.8	
																NP-TPMX160304L-F	★	9.525	3.18	0.4	1.6	4.8	
																NP-TPMX160308L-F	★	9.525	3.18	0.8	1.7	4.8	
(With Breaker)																							
NEW PETIT CUT	NP-TPMH080202R-F	★	4.76	2.38	0.2	1.5	2.4	MD220	IC	S	RE	LE	D1		E009								
																NP-TPMH080202L-F	★	4.76	2.38	0.2	1.5	2.4	
																NP-TPMH080204R-F	★	4.76	2.38	0.4	1.6	2.4	
																NP-TPMH080204L-F	★	4.76	2.38	0.4	1.6	2.4	
																NP-TPMH090202R-F	★	5.56	2.38	0.2	1.5	2.9	
																NP-TPMH090202L-F	★	5.56	2.38	0.2	1.5	2.9	
																NP-TPMH090204R-F	★	5.56	2.38	0.4	1.6	2.9	
																NP-TPMH090204L-F	★	5.56	2.38	0.4	1.6	2.9	
																NP-TPMH110302R-F	★	6.35	3.18	0.2	1.5	3.4	
																NP-TPMH110302L-F	★	6.35	3.18	0.2	1.5	3.4	
																NP-TPMH110304R-F	★	6.35	3.18	0.4	1.6	3.4	
																NP-TPMH110304L-F	★	6.35	3.18	0.4	1.6	3.4	
																NP-TPMH160302R-F	★	9.525	3.18	0.2	1.5	4.4	
																NP-TPMH160302L-F	★	9.525	3.18	0.2	1.5	4.4	
																NP-TPMH160304R-F	★	9.525	3.18	0.4	1.6	4.4	
(With Breaker)																							
NEW PETIT CUT	TPGX080202	★	4.76	2.38	0.2	1.8	2.5	MD220	IC	S	RE	LE	D1		E009 E027								
																TPGX080204	★	4.76	2.38	0.4	1.7	2.5	
																TPGX080208	★	4.76	2.38	0.8	1.4	2.5	
																TPGX090202	★	5.56	2.38	0.2	2.7	3.0	
																TPGX090204	★	5.56	2.38	0.4	2.6	3.0	
																TPGX090208	★	5.56	2.38	0.8	2.3	3.0	
																TPGX110302	★	6.35	3.18	0.2	2.7	3.5	
																TPGX110304	★	6.35	3.18	0.4	2.6	3.5	
																TPGX110308	★	6.35	3.18	0.8	2.3	3.5	
																TPGX160304	★	9.525	3.18	0.4	2.9	4.8	
TPGX160308	★	9.525	3.18	0.8	2.6	4.8																	

★ : Inventory maintained in Japan.



35° VB TYPE INSERTS WITH HOLE

Work Material	N	Non-ferrous Metal	●	Cutting Conditions (Guide) :					PCD	Dimensions (mm)	Geometry	Applicable Holder Page
				● : Stable Cutting	● : General Cutting	✦ : Unstable Cutting						
Shape	Order Number	MD220	IC	S	RE	LE	D1	Geometry	Applicable Holder Page			
		NEW PETIT CUT	NP-VBGT110301R-F	★	6.35	3.18	0.1			2.5	2.85	
	NP-VBGT110302R-F	★	6.35	3.18	0.2	2.5	2.85					
	NP-VBGT110304R-F	★	6.35	3.18	0.4	2.5	2.85					
	NP-VBGT1103V5R-F	★	6.35	3.18	0.05	2.5	2.85					
(With Breaker)												

PCD

B

PCD TURNING INSERTS

POSI
5°
7°

WITH HOLE

C

D

R

S

T

V

W



35° VC TYPE INSERTS WITH HOLE

Work Material	N	Non-ferrous Metal	●	Cutting Conditions (Guide) :					PCD	Dimensions (mm)	Geometry	Applicable Holder Page
				● : Stable Cutting	● : General Cutting	✦ : Unstable Cutting						
Shape	Order Number	MD220	IC	S	RE	LE	D1	Geometry	Applicable Holder Page			
		NEW PETIT CUT	NP-VCGT080201R-F	★	4.76	2.38	0.1			2.5	2.4	
	NP-VCGT080202R-F	★	4.76	2.38	0.2	2.5	2.4					
	NP-VCGT080204R-F	★	4.76	2.38	0.4	2.5	2.4					
	NP-VCGT0802V5R-F	★	4.76	2.38	0.05	2.5	2.4					
	NP-VCGT110301R-F	★	6.35	3.18	0.1	2.5	2.8					
	NP-VCGT110302R-F	★	6.35	3.18	0.2	2.5	2.8					
	NP-VCGT110304R-F	★	6.35	3.18	0.4	2.5	2.8					
(With Breaker)	NP-VCGT1103V5R-F	★	6.35	3.18	0.05	2.5	2.8					
NEW	VCGW110301	★	6.35	3.18	0.1	3.1	2.8		C030 D013 E034			
	VCGW110302	★	6.35	3.18	0.2	3.0	2.8					
	VCGW110304	★	6.35	3.18	0.4	2.6	2.8					

★ = NEW

PCD TURNING INSERTS [POSITIVE]

80° WC TYPE INSERTS WITH HOLE

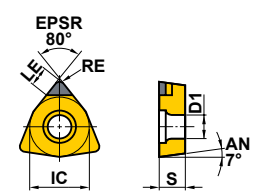
Work Material	N	Non-ferrous Metal	PCD	Cutting Conditions (Guide) :					Geometry	Applicable Holder Page
				● : Stable Cutting	● : General Cutting	✖ : Unstable Cutting				
Shape	Order Number	MD220	Dimensions (mm)					Geometry	Applicable Holder Page	
			IC	S	RE	LE	D1			
	WCMW06T304	★	9.525	3.97	0.4	3.0	4.4		E029	

PCD

B

PCD TURNING INSERTS

POSITIVE
7°
11°

WITH HOLE

C

D

R

S

T

V

W

80° WP TYPE INSERTS WITH HOLE

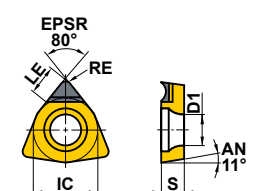
Work Material	N	Non-ferrous Metal	PCD	Cutting Conditions (Guide) :					Geometry	Applicable Holder Page
				● : Stable Cutting	● : General Cutting	✖ : Unstable Cutting				
Shape	Order Number	MD220	Dimensions (mm)					Geometry	Applicable Holder Page	
			IC	S	RE	LE	D1			
	WPGT040202	★	6.35	2.38	0.2	2.9	2.8		E012	
	WPGT040204	★	6.35	2.38	0.4	2.9	2.8			
	WPGT060302	★	9.525	3.18	0.2	3.3	4.4			
	WPGT060304	★	9.525	3.18	0.4	3.3	4.4			
(With Breaker)										

★ : Inventory maintained in Japan.

55° DE TYPE INSERTS WITH HOLE

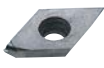
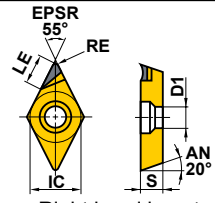
Work Material	N	Non-ferrous Metal	●	Cutting Conditions (Guide) :				PCD	Dimensions (mm)					Geometry	Applicable Holder Page
				● : Stable Cutting	● : General Cutting	✖ : Unstable Cutting	IC		S	RE	LE	D1			
 (With Breaker)			★	12.7	4.76	0.4	2.9	5.1	 Right hand insert shown.	C033					
			★	12.7	4.76	0.4	2.9	5.1							

PCD

B

PCD TURNING INSERTS

POSI 20°

WITH HOLE

C

D

R



S

T

V

W

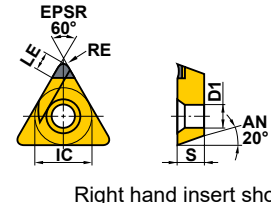
60° TE TYPE INSERTS WITH HOLE

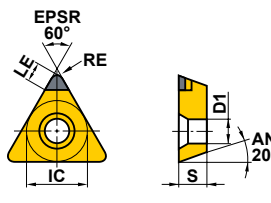
Work Material	N	Non-ferrous Metal	●	Cutting Conditions (Guide) :				PCD	Dimensions (mm)					Geometry	Applicable Holder Page
				● : Stable Cutting	● : General Cutting	✖ : Unstable Cutting	IC		S	RE	LE	D1			
 (With Breaker)			★	9.525	3.18	0.2	3.8	4.4	 Right hand insert shown.	C035 E041					
			★	9.525	3.18	0.2	3.8	4.4							
			★	9.525	3.18	0.4	3.6	4.4							
			★	9.525	3.18	0.4	3.6	4.4							
			★	9.525	3.18	0.2	3.1	4.4	 Right hand insert shown.	C035 E041					
			★	9.525	3.18	0.4	2.9	4.4							

GRADES > B028

IDENTIFICATION > B002

B073

PCD TURNING INSERTS [POSITIVE]

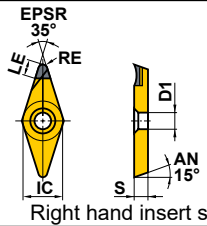

35° VD TYPE INSERTS WITH HOLE

Work Material	N	Non-ferrous Metal	●	Cutting Conditions (Guide) :					Geometry	Applicable Holder Page
				● : Stable Cutting	● : General Cutting	✦ : Unstable Cutting				
Shape	Order Number	PCD	Dimensions (mm)					Geometry	Applicable Holder Page	
		MD220	IC	S	RE	LE	D1			
 (With Breaker)	VDGX160302R-F	●	9.525	3.18	0.2	3.1	4.5	 Right hand insert shown.	C035	
	VDGX160304R-F	●	9.525	3.18	0.4	2.7	4.5			

PCD

B

PCD TURNING INSERTS

POSJ 15°

WITH HOLE

C

D

R

S

T

V

W

● : Inventory maintained. ★ : Inventory maintained in Japan.

90° SP TYPE INSERTS WITHOUT HOLE

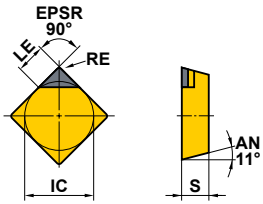
Work Material	N	Non-ferrous Metal	●	Cutting Conditions (Guide) :				
				● : Stable Cutting	● : General Cutting	✦ : Unstable Cutting		
Shape	Order Number	PCD	Dimensions (mm)				Geometry	Applicable Holder Page
		MD220	IC	S	RE	LE		
	SPGN090302	★	9.525	3.18	0.2	3.7		-
	SPGN090304	★	9.525	3.18	0.4	3.7		
	SPGN090308	★	9.525	3.18	0.8	3.8		
	SPGN120304	★	12.7	3.18	0.4	3.7		
	SPGN120308	★	12.7	3.18	0.8	3.8		
	SPGN120312	★	12.7	3.18	1.2	3.7		

PCD

B

PCD TURNING INSERTS

POSI 11°

WITHOUT HOLE

C

D

R

S

T

V

W

60° TP TYPE INSERTS WITHOUT HOLE

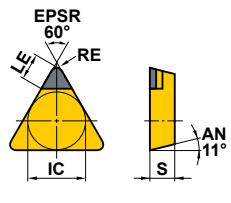
Work Material	N	Non-ferrous Metal	●	Cutting Conditions (Guide) :				
				● : Stable Cutting	● : General Cutting	✦ : Unstable Cutting		
Shape	Order Number	PCD	Dimensions (mm)				Geometry	Applicable Holder Page
		MD220	IC	S	RE	LE		
	TPGN110302	★	6.35	3.18	0.2	2.7		E028
	TPGN110304	★	6.35	3.18	0.4	2.6		
	TPGN110308	★	6.35	3.18	0.8	2.3		
	TPGN160302	★	9.525	3.18	0.2	3.1		
	TPGN160304	★	9.525	3.18	0.4	2.9		
	TPGN160308	★	9.525	3.18	0.8	2.6		

GRADES > B028

IDENTIFICATION > B002

B075

Memo

A series of horizontal dashed lines for writing, spanning the width of the page.

Memo

A series of horizontal dashed lines for writing, spanning the width of the page.

HOW TO READ THE STANDARD OF EXTERNAL TURNING TOOLS

●How this section page is organised

- ① Organised according to turning insert shape.
(Refer to the index on the next page.)

TYPE OF TOOL HOLDER

Indicates the first four letters of the order number, as well as cutting applications.

TITLE OF PRODUCT BY INSERT TYPE

PRODUCT SECTION

EXTERNAL TURNING TOOLS

VN INSERTS TOOL HOLDERS

DVNN External turning, Copying **DOUBLE CLAMP type**

Order Number	Stock	Insert Number	Dimensions (mm)						Shim	Shim Pin	Lock Pin	Lock Screw	Spring	Clamp Socket	Wrench
			H	B	LF	LH	HF	WF							
DVNN2020K16	●	VN A VN G VN M	1604	20	20	125	44	20	10	DC5WZ	LLP13	DC3K113	DC32	DC0207	TKY15F
DVNN2525M16	●	VN A VN G VN M	1604	25	25	150	42	25	12.5	DC5WZ	LLP13	DC3K113	DC32	DC0207	TKY15F

*1 Clamp Torque (N·m) : DC02071-3.5

FIGURE SHOWING THE TOOLING APPLICATION
Uses illustrations and arrows to depict the available machining applications such as external turning, copying, facing, and chamfering together with cutting edge lead angles.

GEOMETRY

CHIPBREAKER BY CUTTING APPLICATION

DVPN Facing, Copying **DOUBLE CLAMP type**

Order Number	Stock	Insert Number	Dimensions (mm)						Shim	Shim Pin	Lock Pin	Lock Screw	Spring	Clamp Socket	Wrench
			H	B	LF	LH	HF	WF							
DVPNRL2020K16	●	VN A VN G VN M	1604	20	20	125	32	20	25	DC5WZ	LLP13	DC3K113	DC32	DC0207	TKY15F
DVPNRL2525M16	●	VN A VN G VN M	1604	25	25	150	32	25	32	DC5WZ	LLP13	DC3K113	DC32	DC0207	TKY15F

*1 Clamp Torque (N·m) : DC02071-3.5

PVNN External turning, Copying **MP type**

Order Number	Stock	Insert Number	Dimensions (mm)						Shim	Lock Pin	Lock Screw	Stop Ring	Wrench	
			H	B	LF	LH	HF	WF						
PVNN2020K16	●	VN A VN G VN M	1604	20	20	125	38	20	10	PV322 (PV321)	P115	HSP05008C	E03	HKY25R
PVNN2525M16	●	VN A VN G VN M	1604	25	25	150	38	25	12.5	PV322 (PV321)	P115	HSP05008C	E03	HKY25R

*1 Clamp Torque (N·m) : HSP05008C>2.5
*2 Please use shim no. PV321 and PV323 with RE0.4mm and RE1.2mm thick inserts. When using inserts, shim should be ordered separately.

PVPN Facing, Copying **MP type**

Order Number	Stock	Insert Number	Dimensions (mm)						Shim	Lock Pin	Lock Screw	Stop Ring	Wrench	
			H	B	LF	LH	HF	WF						
PVPNRL2020K16	●	VN A VN G VN M	1604	20	20	125	32	20	25	PV322 (PV321)	P115	HSP05008C	E03	HKY25R
PVPNRL2525M16	●	VN A VN G VN M	1604	25	25	150	32	25	32	PV322 (PV321)	P115	HSP05008C	E03	HKY25R

*1 Clamp Torque (N·m) : HSP05008C>2.5
*2 Please use shim no. PV321 and PV323 with RE0.4mm and RE1.2mm thick inserts. When using inserts, shim should be ordered separately.

Note 1) The insert photos are only examples. The letters refer to the chip breaker and the dimension refers to the inscribed circle.

● Inventory maintained.
* Inventory maintained in Japan.

● Inventory maintained.
* Inventory maintained in Japan.

LEGEND FOR STOCK STATUS MARK
Is shown on the left hand page of each double-page spread.

REFERENCE PAGE FOR APPLICABLE INSERTS
Indicates reference pages giving details of inserts that are applicable to the product.

PRODUCT STANDARDS
Indicates order numbers, stock status (per right/left hand), applicable inserts, dimensions, and spare parts.

PAGE REFERENCE
· SPARE PARTS
· TECHNICAL DATA
Indicates reference pages, including the above, on the right hand page of each double-page spread.

TURNING

EXTERNAL TURNING TOOLS

CLASSIFICATION.....	C002
IDENTIFICATION	C006
METHOD OF HOLDING	C007
STANDARD HOLDERS	
CN○○INSERTS TOOL HOLDERS.....	C008
DN○○INSERTS TOOL HOLDERS.....	C010
SN○○INSERTS TOOL HOLDERS.....	C012
TN○○INSERTS TOOL HOLDERS.....	C016
VN○○INSERTS TOOL HOLDERS.....	C019
WN○○INSERTS TOOL HOLDERS.....	C022
CC○○INSERTS TOOL HOLDERS.....	C024
DC○○INSERTS TOOL HOLDERS.....	C025
RC○○INSERTS TOOL HOLDERS.....	C026
SC○○INSERTS TOOL HOLDERS.....	C028
TC○○INSERTS TOOL HOLDERS.....	C029
VC○○INSERTS TOOL HOLDERS.....	C030
XC○○INSERTS TOOL HOLDERS.....	C032
TL HOLDER	C037
AL HOLDER	
DE○○INSERTS TOOL HOLDERS	C034
TE○○INSERTS TOOL HOLDERS	C035
VD○○INSERTS TOOL HOLDERS	C036









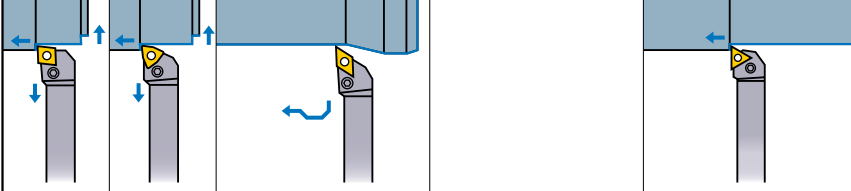

*Alphabetical order index

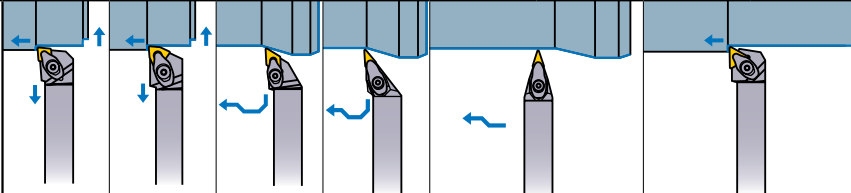
C008 DCLN	C012 PSBN	C029 STGC
C010 DDJN	C014 PSDN	C035 STGE
C016 DTGN	C015 PSKN	C030 SVJC
C019 DVJN	C013 PSSN	C036 SVJD
C021 DVPN	C013 PSTN	C031 SVPC
C020 DVVN	C017 PTFN	C030 SVVC
C022 DWLN	C016 PTGN	C032 SXZC
C009 MCLN	C019 PVJN	C037 TLHR
C012 MSBN	C021 PVPN	
C014 MSSN	C020 PVVN	
C018 MTEN	C022 PWLN	
C017 MTJN	C024 SCLC	
C018 MTQN	C025 SDJC	
C023 MWLN	C034 SDJE	
C009 PCBN	C025 SDNC	
C008 PCLN	C034 SDNE	
C011 PDHN	C027 SRDC	
C010 PDJN	C027 SRGC	
C026 PRDC	C028 SSSC	
C026 PRGC	C035 STFE	

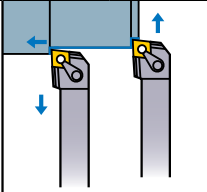
CLASSIFICATION (Negative insert)

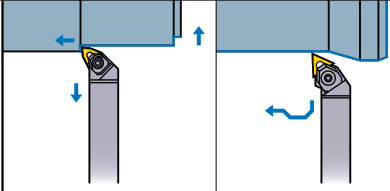
EXTERNAL TURNING TOOLS

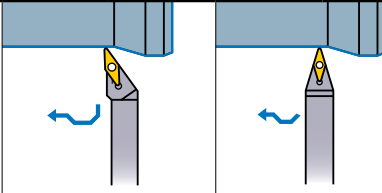





Tool Holder	Features Shank Size (H x W x L)	External Turning Facing		External Turning Copying		External Turning		
		KAPR=95°	KAPR=93°	KAPR=72.5°	KAPR=91°			
LL Holder  <ul style="list-style-type: none"> ● Lever lock type. ● ISO standard. ● Various holder shapes. ● Suitable for light to heavy cutting. ● Economical negative insert. <p>10 x 10 x 70 25 x 25 x 150 12 x 12 x 80 32 x 25 x 170 16 x 16 x 100 32 x 32 x 170 20 x 20 x 125</p>		PCLN ↻ C008	PWLN ↻ C022	PDJN ↻ C010		PTGN ↻ C016		
DOUBLE CLAMP Holder  <ul style="list-style-type: none"> ● Double clamp type. ● Holds inserts securely. ● Excellent cutting edge tolerance. ● Economical negative insert. ● Small insert series. <p>16 x 16 x 100 25 x 25 x 150 20 x 20 x 125 32 x 25 x 170</p>		DCLN ↻ C008	DWLN ↻ C022	DDJN ↻ C010	DVJN ↻ C019	DVVN ↻ C020	DTGN ↻ C016	
DOUBLE CLAMP Holder (For heavy cutting)  <ul style="list-style-type: none"> ● Double clamp holder type. ● Holds inserts securely. ● Suitable for heavy cutting. ● Negative insert. <p>32 x 32 x 170 40 x 40 x 200</p>		MCLN ↻ C009						
WP Holder  <ul style="list-style-type: none"> ● Double clamp holder type. ● Simple insert exchange. ● Economical negative insert. <p>20 x 20 x 125 25 x 25 x 150 32 x 25 x 170</p>		MWLN ↻ C023	MTJN ↻ C017					
MP Holder  <ul style="list-style-type: none"> ● Pin lock type. ● 35° rhombic shape insert. ● Suitable for recessing. <p>20 x 20 x 125 25 x 25 x 150</p>				PVJN ↻ C019	PVJN ↻ C019	PVVN ↻ C020		

	External Turning	External Turning, Chamfering		External Turning, Facing, Chamfering	Facing		Facing Copying	External Turning, Copying	Selection Standard				
	KAPR=75°	KAPR=60°	KAPR=45°	KAPR=45°	KAPR=75°	KAPR=91°	KAPR=105° 107.5° 117.5°	Special Design (Positive inserts)	Economical	Low Cutting Resistance (Sharpness)	Clamp Rigidity	Operation Efficiency	Specialised
	PCBN ↻ C009	PSBN ↻ C012	SSTN ↻ C013	PSDN ↻ C014	PSSN ↻ C013	PSKN ↻ C015	PTFN ↻ C017	PDHN ↻ C011	PRGC ↻ C026	PRDC ↻ C026			
							DVPN ↻ C021						
	MSBN ↻ C012			MSSN ↻ C014									
		MTEN ↻ C018					MTQN ↻ C018						
							PVPN ↻ C021						

Note 1) ◎ : 1st recommendation. ○ : 2nd recommendation.

CLASSIFICATION (Positive insert)

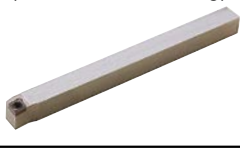
EXTERNAL TURNING TOOLS

Tool Holder	Features Shank Size (H x W x L)	External Turning, Facing	External Turning, Copying	
		KAPR=95°	KAPR=93° 95°	KAPR=62.5° 72.5°
Profile Holder 	<ul style="list-style-type: none"> ● Double clamp holder type. ● 25° rhombic shape insert. ● Possible to machine a face relief with up to 60° inclination. 16 x 16 x 100 20 x 20 x 125 25 x 25 x 150			
SP Holder 	<ul style="list-style-type: none"> ● Screw-on type. ● Miniature holder with 7° positive insert. 8 x 8 x 60 10 x 10 x 70 12 x 12 x 80 16 x 16 x 100 20 x 20 x 125 25 x 25 x 150			
AL Holder (For Aluminium) 	<ul style="list-style-type: none"> ● Screw-on type. ● 20° positive insert. (35° rhombic shape insert is 15°) ● High rake and good sharpness. 16 x 16 x 100 20 x 20 x 125 25 x 25 x 150			
TL Holder 	<ul style="list-style-type: none"> ● Taper lock type ● Excellent finished surface with round shape insert. 20 x 20 x 125 25 x 25 x 150 32 x 25 x 170			
SMALL TOOLS (Tools for front turning) 	<ul style="list-style-type: none"> ● Screw-on type. ● Tools to be equipped on gang type tool posts. ● Miniature holder with 7° positive insert. 8 x 8 x 125 10 x 10 x 125 12 x 12 x 150 16 x 16 x 150			
SMALL TOOLS (Tools for back turning) 	<ul style="list-style-type: none"> ● Screw-on type. ● Tools to be equipped on gang type tool posts. ● High rigidity due to designing of vertical insert. (BTA/CTB type) ● Back machining. (BTA/CTB type) 8 x 10 x 120 10 x 10 x 120 12 x 12 x 120 16 x 16 x 120			

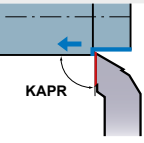
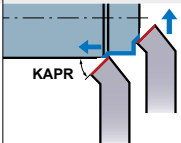
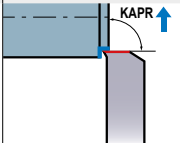
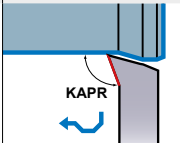
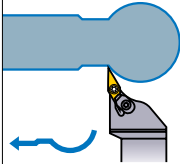
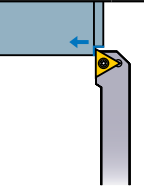
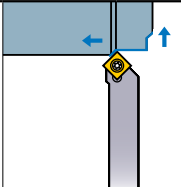
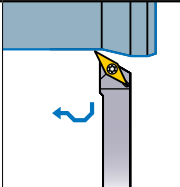
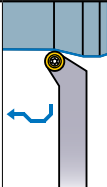
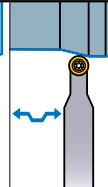
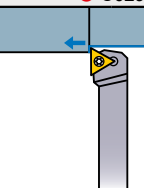
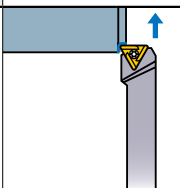
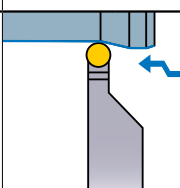
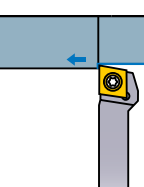
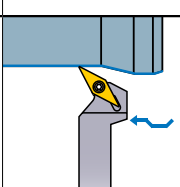
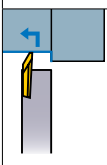
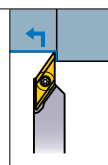
	External Turning	External Turning, Facing, Chamfering	Facing	Facing, Copying	External Turning, Copying	Selection Standard				
	<p>KAPR=90° 91°</p> 	<p>KAPR=45°</p> 	<p>KAPR=91°</p> 	<p>KAPR=117.5°</p> 	<p>Special Design</p> 	Economical	Low Cutting Resistance (Sharpness)	Clamp Rigidity	Operation Efficiency	Specialised
					<p>SXZC ↻ C032</p>	○	○			
	 <p>STGC ↻ C029</p>	 <p>SSSC ↻ C028</p>		 <p>SVPC ↻ C031</p>	 <p>SRGC ↻ C027</p>  <p>SRDC ↻ C027</p>	○				
	 <p>STGE ↻ C035</p>		 <p>STFE ↻ C035</p>			○				○
					 <p>TLHR ↻ C037</p>	○				○
	 <p>SCAC-SM ↻ D010</p>			 <p>SVPP-SM ↻ D013</p>		○				
					<p>Special Design</p>  <p>BTAH/CTBH ↻ D014, D015</p>  <p>BTVH ↻ D016</p>	○				

Note 1) ○ : 1st recommendation. ○ : 2nd recommendation.

IDENTIFICATION

■ LL Holder / Double Clamp Holder /
SP Holder / Profile Holder / AL Holder

P C L N R 25 25 M 12

①Clamp Structure

D	Double Clamp Type
M	Wedge Lock Type Multiple Clamp Type
P	Lever Lock Type
S	Screw-on Type

③Cutting Angle
KAPR

A	90°Without Offset
B	75°
D	45°Neutral
E	60°
F	90°
G	90°With Offset
H	107.5°
J	93°
K	75°
L	95°
N	62.5°
P	117.5°
Q	105°
S	45°
T	60°
V	72.5°
Z	Special

④Insert Clearance

C	7°Positive
N	Negative
E	20°Positive

⑤Hand of Tool

R	Right Hand
L	Left Hand
N	Neutral

⑥Tool Size H/B (mm)
(Height and Width)

8	08
10	10
12	12
16	16
20	20
25	25
32	32

⑦Tool Length
LF (mm)

D	60
E	70
F	80
H	100
K	125
M	150
P	170
Q	180
R	200

⑧Cutting Edge Length (mm)

Inscribed Circle	Insert Shape					
	Square	Triangular	Round	Rhombic 80°	Rhombic 55°	Rhombic 35°
6.00	-	-	06	-	-	-
6.35	-	11	-	06	07	11
7.94	-	13	-	-	-	-
8.00	-	-	08	-	-	-
9.525	09	16	-	09	11	16
10.00	-	-	10	-	-	-
12.00	-	-	12	-	-	-
12.70	12	22	-	12	15	-
15.875	15	27	-	16	-	-
16.00	-	-	16	-	-	-
19.05	19	-	-	19	-	-
20.00	-	-	20	-	-	-
25.00	-	-	25	-	-	-
25.40	25	-	-	-	-	-
32.00	-	-	32	-	-	-

②Insert Shape

C	Rhombic 80°
D	Rhombic 55°
R	Round
S	Square
T	Triangular
V	Rhombic 35°
W	Trigon
X	Special Design

METHOD OF HOLDING

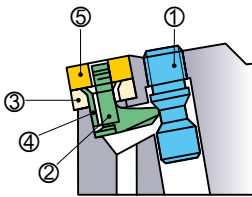
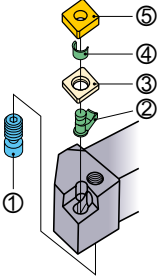
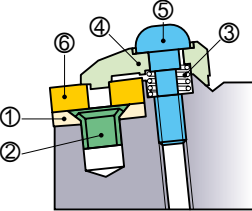
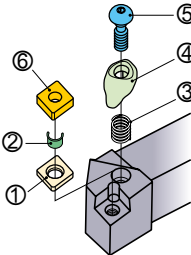
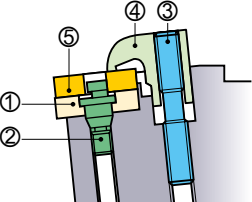
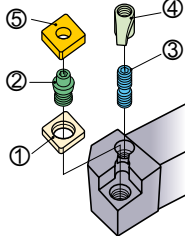
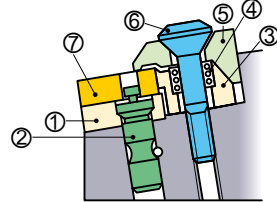
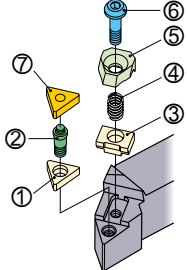
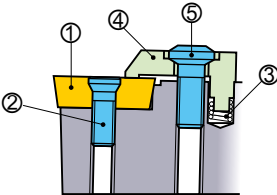
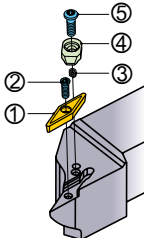
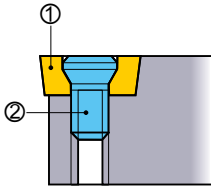
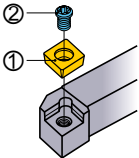
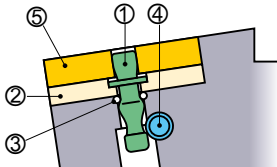
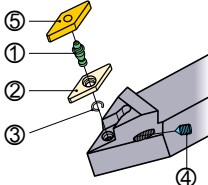
Type (Holder)	Structure	
Lever Lock (LL HOLDER)		 <ul style="list-style-type: none"> ① Clamp Screw ② Lever ③ Shim ④ Shim Pin ⑤ Insert
Double Clamp (DOUBLE CLAMP) HOLDER		 <ul style="list-style-type: none"> ① Shim ② Shim Pin ③ Spring ④ Clamp Bridge ⑤ Clamp Screw ⑥ Insert
Multiple Clamp (DOUBLE CLAMP) HOLDER (For heavy cutting)		 <ul style="list-style-type: none"> ① Shim ② Shim Pin ③ Clamp Screw ④ Clamp Bridge ⑤ Insert
Wedge Lock (WP HOLDER)		 <ul style="list-style-type: none"> ① Shim ② Shim Pin ③ Plate ④ Spring ⑤ Clamp Bridge ⑥ Clamp Screw ⑦ Insert
Two Action Double Clamp (PROFILE HOLDER)		 <ul style="list-style-type: none"> ① Insert ② Clamp Screw (1) ③ Spring ④ Clamp Bridge ⑤ Clamp Screw (2)
Screw-on (SP HOLDER) (AL HOLDER)		 <ul style="list-style-type: none"> ① Insert ② Clamp Screw
Pin Lock (MP HOLDER)		 <ul style="list-style-type: none"> ① Lock Pin ② Shim ③ Stop Ring ④ Lock Screw ⑤ Insert

EXTERNAL TURNING TOOLS

CN INSERTS TOOL HOLDERS

PCLN

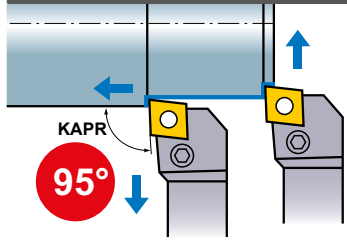

External turning, Facing **LL type**

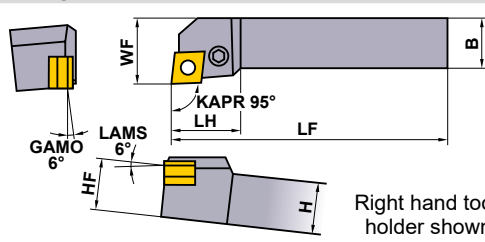

Finish	Light	Medium	Medium
FP	LP	MP	MK
(12)	(12)	(12,16,19)	(12,16,19)
Medium	Medium to Rough	Stainless	CBN
Standard	RP	MM	
(09,12,16,19)	(12,16,19)	(12,16,19)	(12)

Order Number	Stock		Insert Number	Dimensions (mm)							Shim	Shim Pin	Clamp Lever	Clamp Screw*	Wrench
	R	L		H	B	LF	LH	HF	WF						
PCLNR/L1616H09	●	●	CNMG	09T3	16	16	100	22	16	20	LLSCN3T3	LLP13	LLCL13	LLCS106	HKY25R
PCLNR/L2020K09	●	●		09T3	20	20	125	22	20	25	LLSCN3T3	LLP13	LLCL13	LLCS106	HKY25R
PCLNR/L2525M09	●	●		09T3	25	25	150	22	25	32	LLSCN3T3	LLP13	LLCL13	LLCS106	HKY25R
PCLNR/L2020K12	●	●	CNMA CNMG CNMM CNGA CNGG CNGM	1204	20	20	125	28	20	25	LLSCN42	LLP14	LLCL14	LLCS108	HKY30R
PCLNR/L2525M12	●	●		1204	25	25	150	28	25	32	LLSCN42	LLP14	LLCL14	LLCS108	HKY30R
PCLNR/L3225P12	●	●		1204	32	25	170	28	32	32	LLSCN42	LLP14	LLCL14	LLCS108	HKY30R
PCLNR/L3232P16	●	●		1606	32	32	170	32	32	40	LLSCN53	LLP15	LLCL25	LLCS508	HKY30R
PCLNR/L3232P19	●	●		1906	32	32	170	40	32	40	LLSCN63	LLP16	LLCL16	LLCS310	HKY40R

* Clamp Torque (N · m) : LLCS106=2.2, LLCS108=3.3, LLCS508=3.3, LLCS310=7.0

DCLN

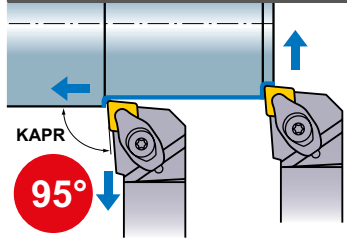

External turning, Facing **DOUBLE CLAMP type**

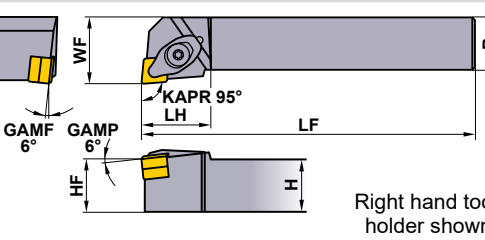

Finish	Light	Medium	Medium
FP	LP	MP	MK
(12)	(12)	(12)	(12)
Medium	Medium to Rough	Stainless	CBN
Standard	RP	MM	
(09,12)	(12)	(12)	(12)

Order Number	Stock		Insert Number	Dimensions (mm)							Shim*2	Shim Pin	Clamp Bridge	Spring	Clamp Screw*1	Wrench
	R	L		H	B	LF	LH	HF	WF							
DCLNR/L1616H09	●	●	CNMG	09T3	16	16	100	25	16	20	LLSCN3T3 (LLSCN33)	LLP23	DCK2211	DCS2	DC0520T	TKY15F
DCLNR/L1616H09-T	●	●		0903	16	16	100	25	16	20	LLSCN33	LLP23	DCK2211	DCS2	DC0520T	TKY15F
DCLNR/L2020K09	●	●		09T3	20	20	125	25	20	25	LLSCN3T3 (LLSCN33)	LLP23	DCK2211	DCS2	DC0520T	TKY15F
DCLNR/L2020K09-T	●	●		0903	20	20	125	25	20	25	LLSCN33	LLP23	DCK2211	DCS2	DC0520T	TKY15F
DCLNR/L2525M09	●	●		09T3	25	25	150	25	25	32	LLSCN3T3 (LLSCN33)	LLP23	DCK2211	DCS2	DC0520T	TKY15F
DCLNR/L2525M09-T	●	●		0903	25	25	150	25	25	32	LLSCN33	LLP23	DCK2211	DCS2	DC0520T	TKY15F
DCLNR/L2020K12	●	●	CNMA CNMG CNMM CNGA CNGG CNGM	1204	20	20	125	29	20	25	LLSCN42	LLP14	DCK2613	DCS1	DC0621T	TKY20F
DCLNR/L2525M12	●	●		1204	25	25	150	29	25	32	LLSCN42	LLP14	DCK2613	DCS1	DC0621T	TKY20F
DCLNR/L3225P12	●	●		1204	32	25	170	29	32	32	LLSCN42	LLP14	DCK2613	DCS1	DC0621T	TKY20F

*1 Clamp Torque (N · m) : DC0520T=3.5, DC0621T=5.0

*2 Please use shim no. LLSCN33 with 3.18mm thick inserts. When using 3.18mm thick inserts, the shim should be ordered separately.

Note 1) The insert photos are only examples. The letters refer to the chipbreaker and the dimension refers to the inscribed circle.

● : Inventory maintained.

PCLN type inserts > A098—A104
DCLN type inserts > A098—A104

PCBN & PCD inserts > B036—B038, B064
RECOMMENDED CUTTING CONDITIONS > A074, B020

Order Number		Stock	Insert Number		Dimensions (mm)						Accessories				
					H	B	LF	LH	HF	WF	Shim	Shim Pin	Clamp Bridge	Clamp Screw *	Wrench
MCLNR3232P19	●		CNMG	1906	32	32	170	36	32	40	MSCN63	MP6	CKW6	LS25	HKY40R
MCLNR4040R19	●		CNMM CNMA	1906	40	40	200	36	40	50	MSCN63	MP6	CKW6	LS25	HKY40R

* Clamp Torque (N · m) : LS25=8.2

Order Number		Stock	Insert Number		Dimensions (mm)						Accessories				
					H	B	LF	LH	HF	WF	Shim	Shim Pin	Clamp Lever	Clamp Screw *	Wrench
PCBNR/L2020K12	●●		CNMA CNGG	1204	20	20	125	28	20	17	LLSCN42	LLP14	LLCL14	LLCS108	HKY30R
PCBNR/L2525M12	●●		CNMA CNOM	1204	25	25	150	25	25	22	LLSCN42	LLP14	LLCL14	LLCS108	HKY30R

* Clamp Torque (N · m) : LLCS108=3.3

MCLN type inserts	> A100 – A104
PCBN type inserts	> A098 – A104
PCBN & PCD inserts	> B036 – B038, B064

RECOMMENDED CUTTING CONDITIONS	> A074, B020
SPARE PARTS	> N001
TECHNICAL DATA	> P001

EXTERNAL TURNING TOOLS

DN INSERTS TOOL HOLDERS



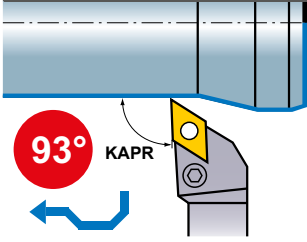



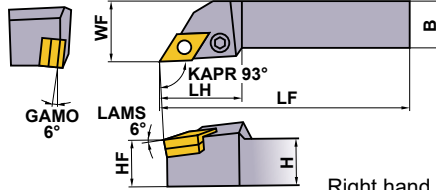

PDJN



External turning, Copying **LL type**



Right hand tool holder shown.

Finish	Light	Medium	Medium
FP	LP	MP	MK
 (15)	 (15)	 (15)	 (15)
Medium to Rough	Stainless	G Class	CBN
RP	MM	R/L	
 (15)	 (15)	 (15)	 (15)

Order Number	Stock		Insert Number	Dimensions (mm)							Accessories				
	R	L		H	B	LF	LH	HF	WF	*2 Shim	Shim Pin	Clamp Lever	*1 Clamp Screw	Wrench	
PDJNR/L2020K15	●	●	DNMA DNMG DNMM DNMX DNGA DNGG DNGM	1504	20	20	125	35	20	25	LLSDN43 (LLSDN42)	LLP14	LLCL24	LLCS108	HKY30R
PDJNR/L2525M15	●	●		1504	25	25	150	35	25	32	LLSDN43 (LLSDN42)	LLP14	LLCL24	LLCS108	HKY30R
PDJNR/L3225P15	●	●		1504	32	25	170	35	32	32	LLSDN43 (LLSDN42)	LLP14	LLCL24	LLCS108	HKY30R

*1 Clamp Torque (N · m) : LLCS108=3.3

*2 Please use shim no. LLSDN42 with 6.35mm thick inserts. When using 6.35mm thick inserts, the shim should be ordered separately.

EXTERNAL TURNING TOOLS



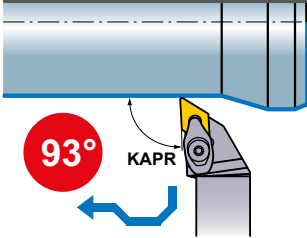



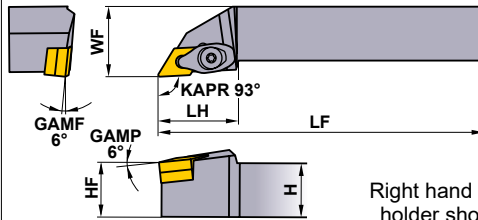

DDJN



External turning, Copying **DOUBLE CLAMP type**



Right hand tool holder shown.

Finish	Light	Medium	Medium
FP	LP	MP	MK
 (15)	 (11,15)	 (15)	 (11,15)
Medium to Rough	Stainless	G Class	CBN
RP	MM	R/L	
 (15)	 (15)	 (15)	 (15)

Order Number	Stock		Insert Number	Dimensions (mm)							Accessories					
	R	L		H	B	LF	LH	HF	WF	*2 Shim	Shim Pin	Clamp Bridge	Spring	*1 Clamp Screw	Wrench	
DDJNR/L1616H11	●	●	DNMG DNGA	1104	16	16	100	28	16	20	LLSDN32	LLP23	DCK2211	DCS2	DC0520T	TKY15F
DDJNR/L2020K11	●	●		1104	20	20	125	28	20	25	LLSDN32	LLP23	DCK2211	DCS2	DC0520T	TKY15F
DDJNR/L2525M11	●	●		1104	25	25	150	28	25	32	LLSDN32	LLP23	DCK2211	DCS2	DC0520T	TKY15F
DDJNR/L3225P11	●	●		1104	32	25	170	28	32	32	LLSDN32	LLP23	DCK2211	DCS2	DC0520T	TKY15F
DDJNR/L2020K15	●	●	DNMA DNMG DNMM DNMX DNGA DNGG DNGM	1504	20	20	125	37	20	25	LLSDN43 (LLSDN42)	LLP24	DCK2613	DCS1	DC0621T	TKY20F
DDJNR/L2020K15-T	●	●		1506	20	20	125	37	20	25	LLSDN42	LLP24	DCK2613	DCS1	DC0621T	TKY20F
DDJNR/L2525M15	●	●		1504	25	25	150	37	25	32	LLSDN43 (LLSDN42)	LLP24	DCK2613	DCS1	DC0621T	TKY20F
DDJNR/L2525M15-T	●	●		1506	25	25	150	37	25	32	LLSDN42	LLP24	DCK2613	DCS1	DC0621T	TKY20F
DDJNR/L3225P15	●	●		1504	32	25	170	37	32	32	LLSDN43 (LLSDN42)	LLP24	DCK2613	DCS1	DC0621T	TKY20F
DDJNR/L3225P15-T	●	●		1506	32	25	170	37	32	32	LLSDN42	LLP24	DCK2613	DCS1	DC0621T	TKY20F

*1 Clamp Torque (N · m) : DC0520T=3.5, DC0621T=5.0

*2 Please use shim no. LLSDN42 with 6.35mm thick inserts. When using 6.35mm thick inserts, the shim should be ordered separately.

Note 1) The insert photos are only examples. The letters refer to the chipbreaker and the dimension refers to the inscribed circle.

● : Inventory maintained.

PDJN type inserts > A105–A111
DDJN type inserts > A105–A111

PCBN & PCD inserts > B039–B042, B064
RECOMMENDED CUTTING CONDITIONS > A074, B020

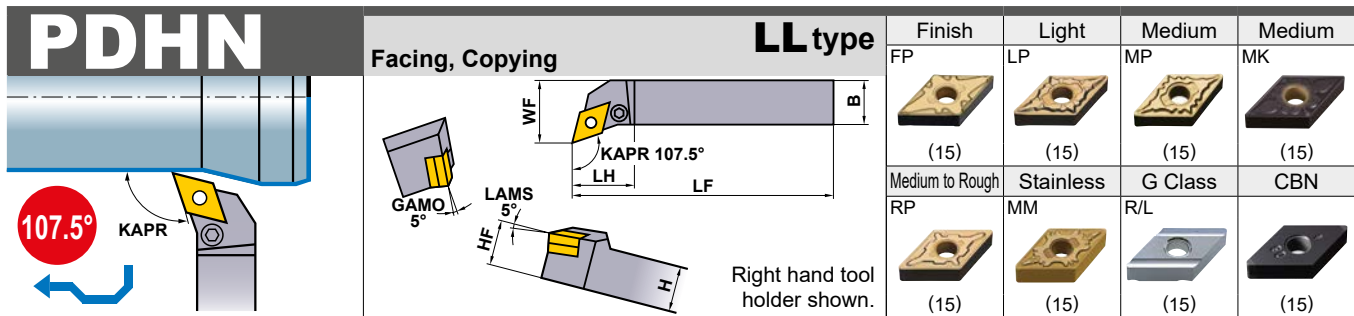

Order Number	Stock		Insert Number	Dimensions (mm)							Accessories				
	R	L		H	B	LF	LH	HF	WF	*2 Shim	Shim Pin	Clamp Lever	*1 Clamp Screw	Wrench	
PDHNR/L2020K15	●	●	DNMA DNMG DNMM	1504	20	20	125	34	20	25	LLSDN43 (LLSDN42)	LLP14	LLCL24	LLCS108	HKY30R
PDHNR/L2525M15	●	●	DNGA DNMG DNGG	1504	25	25	150	34	25	32	LLSDN43 (LLSDN42)	LLP14	LLCL24	LLCS108	HKY30R
PDHNR/L3225P15	●	●	DNGM	1504	32	25	170	34	32	32	LLSDN43 (LLSDN42)	LLP14	LLCL24	LLCS108	HKY30R

*1 Clamp Torque (N • m) : LLCS108=3.3

*2 Please use shim no. LLSDN42 with 6.35mm thick inserts. When using 6.35mm thick inserts, the shim should be ordered separately.

EXTERNAL TURNING TOOLS

PDHN type inserts	> A105–A111
PCBN & PCD inserts	> B039–B042, B064
RECOMMENDED CUTTING CONDITIONS	> A074, B020

SPARE PARTS	> N001
TECHNICAL DATA	> P001

EXTERNAL TURNING TOOLS

SN INSERTS TOOL HOLDERS

PSBN

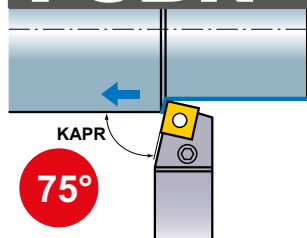

External turning LL type

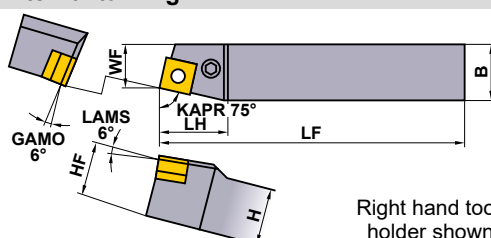

Finish	Light	Medium	Medium
FP (12)	LP (12)	MP (12)	MK (12,15,19)
Medium to Rough RP (12,15,19)	Stainless MM (12,15,19)	G Class R/L (09,12)	CBN (12)

Right hand tool holder shown.

Order Number	Stock		Insert Number	Dimensions (mm)						Accessories						
	R	L		H	B	LF	LH	HF	WF	Shim	Shim Pin	Lever Spring	Clamp Lever	Clamp Screw*	Wrench	
PSBNR/L1212F09	●		SNMA SNMG SNMM SNGA SNGG	0903	12	12	80	20	12	13	—	—	HLS2	LLCL13S	LLCS105	HKY20R
PSBNR/L1616H09	●	●		0903	16	16	100	22	16	13	LLSSN33	LLP23	—	LLCL13	LLCS106	HKY25R
PSBNR/L2020K12	●	●		1204	20	20	125	28	20	17	LLSSN42	LLP14	—	LLCL14	LLCS108	HKY30R
PSBNR/L2525M12	●	●		1204	25	25	150	25	25	22	LLSSN42	LLP14	—	LLCL14	LLCS108	HKY30R
PSBNR/L2525M15	●	●		1506	25	25	150	33	25	22	LLSSN53	LLP15	—	LLCL25	LLCS508	HKY30R
PSBNR/L3232P19	●	●		1906	32	32	170	40	32	27	LLSSN63	LLP16	—	LLCL16	LLCS310	HKY40R

* Clamp Torque (N · m) : LLCS105=1.5, LLCS106=2.2, LLCS108=3.3, LLCS508=3.3, LLCS310=7.0

EXTERNAL TURNING TOOLS

C

MSBN

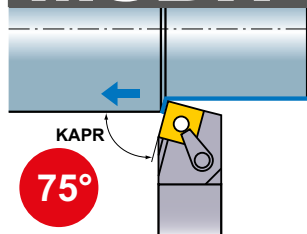

External turning DOUBLE CLAMP type For heavy cutting

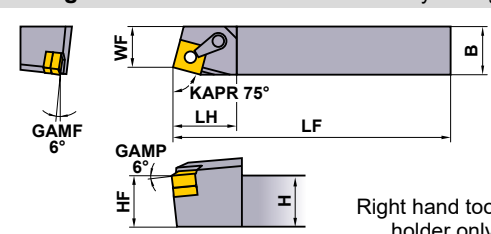

Medium	Medium	Medium	Medium to Rough
MH (19)	Standard (19)	MS (19)	RP (19)
Heavy HZ (19)	Heavy HX (19)	Heavy HL (19)	M Class Flat Top (19)

Right hand tool holder only.

Order Number	Stock		Insert Number	Dimensions (mm)						Accessories					
	R	L		H	B	LF	LH	HF	WF	Shim	Shim Pin	Clamp Bridge	Clamp Screw*	Wrench	
MSBNR3232P19	●		SNMG SNMM SNMA	1906	32	32	170	41	32	27	MSSN63	MP6	CKW6	LS25	HKY40R
MSBNR4040R19	●			1906	40	40	200	41	40	35	MSSN63	MP6	CKW6	LS25	HKY40R

* Clamp Torque (N · m) : LS25=8.2

Note 1) The insert photos are only examples. The letters refer to the chipbreaker and the dimension refers to the inscribed circle.

Order Number		Stock		Insert Number		Dimensions (mm)							Shim		Shim Pin		Clamp Lever		Clamp Screw *		Wrench	
		R	L			H	B	LF	LH	HF	WF	Shim	Shim Pin	Clamp Lever	Clamp Screw	Wrench						
PSTNR/L1616H09		●	●	SNMA SNMG SNMM SNGA SNGG	0903	16	16	100	20	16	13	LLSSN33	LLP23	LLCL13	LLCS106	HKY25R						
PSTNR/L2020K12		●	★		1204	20	20	125	25	20	17	LLSSN42	LLP14	LLCL14	LLCS108	HKY30R						
PSTNR/L2525M12		●	●		1204	25	25	150	25	25	22	LLSSN42	LLP14	LLCL14	LLCS108	HKY30R						

* Clamp Torque (N · m) : LLCS106=2.2, LLCS108=3.3

Order Number		Stock		Insert Number		Dimensions (mm)								Shim		Shim Pin		Clamp Lever		Clamp Screw *		Wrench	
		R	L			H	B	LF	LH	HF	WF	WF2	Shim	Shim Pin	Clamp Lever	Clamp Screw	Wrench						
PSSNR/L1616H09		●	●	SNMA SNMG SNMM SNGA SNGG	0903	16	16	100	22	16	20	(14)	LLSSN33	LLP23	LLCL13	LLCS106	HKY25R						
PSSNR/L2020K12		●	●		1204	20	20	125	31	20	25	(17)	LLSSN42	LLP14	LLCL14	LLCS108	HKY30R						
PSSNR/L2525M12		●	●		1204	25	25	150	31	25	32	(24)	LLSSN42	LLP14	LLCL14	LLCS108	HKY30R						
PSSNR/L3232P15		●	●		1506	32	32	170	34	32	40	(29)	LLSSN53	LLP15	LLCL25	LLCS508	HKY30R						
PSSNR/L3232P19		●	●		1906	32	32	170	40	32	40	(27)	LLSSN63	LLP16	LLCL16	LLCS310	HKY40R						

Note 1) When facing or chamfering only and using insert with right or left hand breaker, please use left hand insert for right hand holder and right hand insert for left hand holder.

* Clamp Torque (N · m) : LLCS106=2.2, LLCS108=3.3, LLCS508=3.3, LLCS310=7.0

PSTN type inserts > A113–A118
 PSSN type inserts > A113–A118
 PCBN & PCD inserts > B043, B065

RECOMMENDED CUTTING CONDITIONS > A074, B020
 SPARE PARTS > N001
 TECHNICAL DATA > P001

EXTERNAL TURNING TOOLS

SN INSERTS TOOL HOLDERS

MSSN

External turning, Facing, Chamfering **DOUBLE CLAMP type**
For heavy cutting

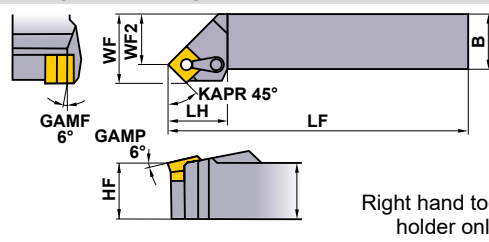
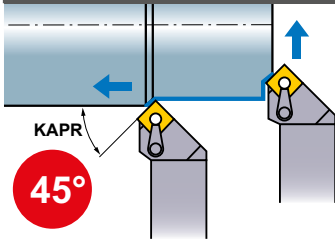

Medium MH (19)	Medium Standard (19)	Medium MS (19)	Rough RP (19)
Heavy HZ (19)	Heavy HX (19)	Heavy HL (19)	M Class Flat Top (19)

Right hand tool holder only.

Order Number	Stock R	Insert Number	Dimensions (mm)							Tools					
			H	B	LF	LH	HF	WF	WF2	Shim	Shim Pin	Clamp Bridge	Clamp Screw*	Wrench	
MSSNR3232P19	●	SNMG SNMM SNMA	1906	32	32	170	44	32	40	27	MSSN63	MP6	CKW6	LS25	HKY40R
MSSNR4040R19	●	SNMG SNMM SNMA	1906	40	40	200	44	40	50	37	MSSN63	MP6	CKW6	LS25	HKY40R

* Clamp Torque (N · m) : LS25=8.2

EXTERNAL TURNING TOOLS

PSDN

External turning, Chamfering **LL type**

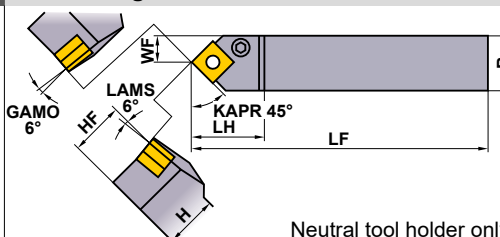
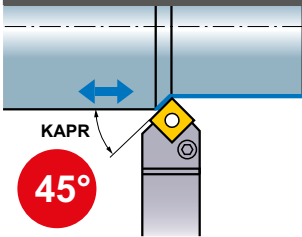

Finish FP (12)	Light LP (12)	Medium MP (12)	Medium MK (12)
Medium to Rough RP (12)	Stainless MM (12)	G Class R/L (09,12)	CBN (12)

Neutral tool holder only.

Order Number	Stock	Insert Number	Dimensions (mm)							Tools					
			H	B	LF	LH	HF	WF	Shim	Shim Pin	Lever Spring	Clamp Lever	Clamp Screw*	Wrench	
PSDNN1212F09	●	SNMA SNMG SNMM SNGA SNGG	0903	12	12	80	20	12	6.0	—	—	HLS2	LLCL13S	LLCS105	HKY20R
PSDNN1616H09	●	SNMA SNMG SNMM SNGA SNGG	0903	16	16	100	22	16	8.0	LLSSN33	LLP23	—	LLCL13	LLCS106	HKY25R
PSDNN2020K12	●	SNMA SNMG SNMM SNGA SNGG	1204	20	20	125	28	20	10.0	LLSSN42	LLP14	—	LLCL14	LLCS108	HKY30R
PSDNN2525M12	●	SNMA SNMG SNMM SNGA SNGG	1204	25	25	150	28	25	12.5	LLSSN42	LLP14	—	LLCL14	LLCS108	HKY30R
PSDNN3225P12	●	SNMA SNMG SNMM SNGA SNGG	1204	32	25	170	28	32	12.5	LLSSN42	LLP14	—	LLCL14	LLCS108	HKY30R

* Clamp Torque (N · m) : LLCS105=1.5, LLCS106=2.2, LLCS108=3.3

Note 1) The insert photos are only examples. The letters refer to the chipbreaker and the dimension refers to the inscribed circle.

● : Inventory maintained.

MSSN type inserts > A114–A118
PSDN type inserts > A113–A118

PCBN & PCD inserts > B043, B065
RECOMMENDED CUTTING CONDITIONS > A074, B020

PSKN		Facing								LL type				
		Stock		Insert Number		Dimensions (mm)				Shim	Shim Pin	Clamp Lever	Clamp Screw*	Wrench
R	L	H	B	LF	LH	HF	WF	Shim	Shim Pin	Clamp Lever	Clamp Screw*	Wrench		
●	●	16	16	100	20	16	20	LLSSN33	LLP23	LLCL13	LLCS106	HKY25R		
●	●	20	20	125	25	20	25	LLSSN42	LLP14	LLCL14	LLCS108	HKY30R		
●	●	25	25	150	25	25	32	LLSSN42	LLP14	LLCL14	LLCS108	HKY30R		

Note 1) When using inserts with right or left hand chipbreakers, please use left hand inserts for right hand holders and right hand inserts for left hand holders.

* Clamp Torque (N • m) : LLCS106=2.2, LLCS108=3.3

EXTERNAL TURNING TOOLS

PSKN type inserts > A113–A118
 PCBN & PCD inserts > B043, B065
 RECOMMENDED CUTTING CONDITIONS > A074, B020

SPARE PARTS > N001
 TECHNICAL DATA > P001

EXTERNAL TURNING TOOLS

TN INSERTS TOOL HOLDERS

PTGN

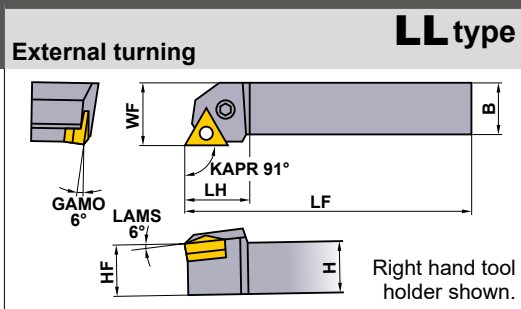
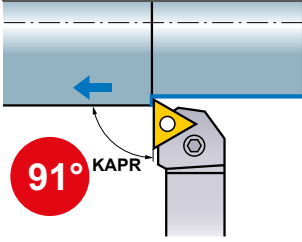

Finish	Light	Medium	Medium
FP (16)	LP (16,22)	MP (16,22)	MK (16,22)
Medium to Rough RP (16,22,27)	Stainless MM (16,22)	G Class R/L (11,16,22)	CBN (16)

Order Number	Stock		Insert Number	Dimensions (mm)							*2		*2		*1	
	R	L		H	B	LF	LH	HF	WF	Shim	Shim Pin	Lever Spring	Clamp Lever	Clamp Screw	Wrench	
PTGNR/L1010E11	●	●	TNMA TNMG TNMM TNGA TNGG TNGM	1103	10	10	70	17	10	12	—	—	HLS1	LLCL12S	LLCS105	HKY20F
PTGNR/L1212F11	●	●		1103	12	12	80	17	12	16	—	—	HLS1	LLCL12S	LLCS105	HKY20F
PTGNR/L1616H16	●	●		1604	16	16	100	22	16	20	LLSTN32 (LLSTN33)	LLP13 (LLP23)	—	LLCL13	LLCS106	HKY25R
PTGNR/L2020K16	●	●		1604	20	20	125	22	20	25	LLSTN32 (LLSTN33)	LLP13 (LLP23)	—	LLCL13	LLCS106	HKY25R
PTGNR/L2525M16	●	●		1604	25	25	150	22	25	32	LLSTN32 (LLSTN33)	LLP13 (LLP23)	—	LLCL13	LLCS206	HKY25R
PTGNR/L2525M22	●	●		2204	25	25	150	28	25	32	LLSTN42	LLP14	—	LLCL14	LLCS108	HKY30R
PTGNR/L3225P22	●	●		2204	32	25	170	28	32	32	LLSTN42	LLP14	—	LLCL14	LLCS108	HKY30R
PTGNR/L3232P27	●	●		2706	32	32	170	35	32	40	LLSTN53	LLP15	—	LLCL25	LLCS508	HKY30R

*1 Clamp Torque (N · m) : LLCS105=1.5, LLCS106=2.2, LLCS206=2.2, LLCS108=3.3, LLCS508=3.3

PTGNR/L1010E11 · PTGNR/L1212F11 Clamp Torque (N · m) : LLCS105=1.0

*2 Please use shim no. LLSTN33 and shim pin no. LLP23 with 3.18mm thick inserts. When using 3.18mm thick inserts, the shim and shim pin should be ordered separately.

EXTERNAL TURNING TOOLS

C

DTGN

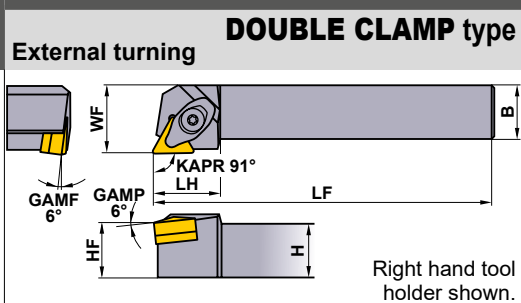
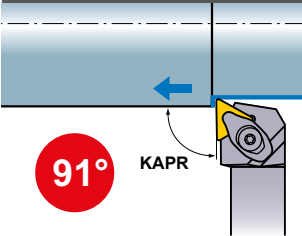

Finish	Light	Medium	Medium
FP (16)	LP (16)	MP (16)	MK (16)
Medium to Rough RP (16)	Stainless MM (16)	G Class R/L (16)	CBN (16)

Order Number	Stock		Insert Number	Dimensions (mm)							*2		*2		*1	
	R	L		H	B	LF	LH	HF	WF	Shim	Shim Pin	Clamp Bridge	Spring	Clamp Screw	Wrench	
DTGNR/L1616H16	●	●	TNMA TNMG TNMM TNGA TNGG TNGM	1604	16	16	100	25	16	20	LLSTN32 (LLSTN33)	LLP23	DCK2211	DCS2	DC0520T	TKY15F
DTGNR/L1616H16-T	●	●		1603	16	16	100	25	16	20	LLSTN33	LLP23	DCK2211	DCS2	DC0520T	TKY15F
DTGNR/L2020K16	●	●		1604	20	20	125	25	20	25	LLSTN32 (LLSTN33)	LLP23	DCK2211	DCS2	DC0520T	TKY15F
DTGNR/L2020K16-T	●	●		1603	20	20	125	25	20	25	LLSTN33	LLP23	DCK2211	DCS2	DC0520T	TKY15F
DTGNR/L2525M16	●	●		1604	25	25	150	25	25	32	LLSTN32 (LLSTN33)	LLP23	DCK2211	DCS2	DC0520T	TKY15F
DTGNR/L2525M16-T	●	●		1603	25	25	150	25	25	32	LLSTN33	LLP23	DCK2211	DCS2	DC0520T	TKY15F

*1 Clamp Torque (N · m) : DC0520T=3.5

*2 Please use shim no. LLSTN33 with 3.18mm thick inserts. When using 3.18mm thick inserts, the shim should be ordered separately.

Note 1) The insert photos are only examples. The letters refer to the chipbreaker and the dimension refers to the inscribed circle.

● : Inventory maintained.

PTGN type inserts > A119-A125
DTGN type inserts > A119-A125

PCBN & PCD inserts > B044, B045, B065
RECOMMENDED CUTTING CONDITIONS > A074, B020

Order Number		Stock		Insert Number		Dimensions (mm)					*2		*1			
		R	L			H	B	LF	LH	HF	WF	Shim	Shim Pin	Clamp Lever	Clamp Screw	Wrench
PTFNR/L1616H16		●	●	TNMA TNMG TNMM TNGA TNGG TNGM	1604	16	16	100	22	16	20	LLSTN32 (LLSTN33)	LLP13 (LLP23)	LLCL13	LLCS106	HKY25R
PTFNR/L2020K16		●	●		1604	20	20	125	22	20	25	LLSTN32 (LLSTN33)	LLP13 (LLP23)	LLCL13	LLCS106	HKY25R
PTFNR/L2525M16		●	●		1604	25	25	150	22	25	32	LLSTN32 (LLSTN33)	LLP13 (LLP23)	LLCL13	LLCS206	HKY25R
PTFNR/L2525M22		●	●		2204	25	25	150	28	25	32	LLSTN42	LLP14	LLCL14	LLCS108	HKY30R

Note 1) When using inserts with right or left hand chipbreakers, please use left hand inserts for right hand holders and right hand inserts for left hand holders.

*1 Clamp Torque (N · m) : LLCS106=2.2, LLCS206=2.2, LLCS108=3.3

*2 Please use shim no. LLSTN33 and shim pin no. LLP23 with 3.18mm thick inserts. When using 3.18mm thick inserts, the shim should be ordered separately.

Order Number		Stock		Insert Number		Dimensions (mm)					*2		*1		*2			
		R	L			H	B	LF	LH	HF	WF	Shim	Shim Pin	Clamp Bridge	Side Lock Plate	Spring	Clamp Screw	Wrench
MTJNR/L2020K16N		●	●	TN \circ A TN \circ G TN \circ M TNMX	1604	20	20	125	31	20	25	WPSTN33	CCP33	CCK13	CPT13	MES2	SLCS105	HKY25R HKY40R
MTJNR/L2525M16N		●	●		1604	25	25	150	31	25	32	WPSTN33	CCP33	CCK13	CPT13	MES2	SLCS105	HKY25R HKY40R
MTJNR/L2525M22N		●	●		2204	25	25	150	38	25	32	WPSTN43	CCP34	CCK14	CPT14	MES3	SLCS106	HKY30R HKY40R

*1 Clamp Torque (N · m) : SLCS105=7.0, SLCS106=7.0

*2 HKY25R, HKY30R Wrench for Shim Pin, HKY40R Wrench for Clamp Screw.

PTFN type inserts	> A119 – A125
MTJN type inserts	> A119 – A125
PCBN & PCD inserts	> B044, B045, B065

RECOMMENDED CUTTING CONDITIONS	> A074, B020
SPARE PARTS	> N001
TECHNICAL DATA	> P001

EXTERNAL TURNING TOOLS

TN INSERTS TOOL HOLDERS

EXTERNAL TURNING TOOLS

Order Number		Stock	Insert Number	Dimensions (mm)							Accessories						
				H	B	LF	LH	HF	WF	Shim	Shim Pin	Clamp Bridge	Side Lock Plate	Spring	Clamp Screw	Wrench	
MTENN2020K16N		●	TN: A TN: G	1604	20	20	125	34	20	10	WPSTN33	CCP33	CCK13	CPT13	MES2	SLCS105	HKY25R HKY40R
MTENN2525M22N		●	TN: M TNMX	2204	25	25	150	44	25	12.5	WPSTN43	CCP34	CCK14	CPT14	MES3	SLCS106	HKY30R HKY40R

*1 Clamp Torque (N • m) : SLCS105=7.0, SLCS106=7.0
 *2 HKY25R, HKY30R Wrench for Shim Pin, HKY40R Wrench for Clamp Screw.

Order Number		Stock	Insert Number	Dimensions (mm)							Accessories						
				H	B	LF	LH	HF	WF	Shim	Shim Pin	Clamp Bridge	Side Lock Plate	Spring	Clamp Screw	Wrench	
MTQNR/L2020K16N		●●	TN: A TN: G	1604	20	20	125	31	20	25	WPSTN33	CCP33	CCK13	CPT13	MES2	SLCS105	HKY25R HKY40R
MTQNR/L2525M22N		●●	TN: M TNMX	2204	25	25	150	36	25	32	WPSTN43	CCP34	CCK14	CPT14	MES3	SLCS106	HKY30R HKY40R

Note 1) When facing only and using inserts with right or left hand chipbreakers, please use left hand inserts for right hand holders and right hand inserts for left hand holders.

*1 Clamp Torque (N • m) : SLCS105=7.0, SLCS106=7.0
 *2 HKY25R, HKY30R Wrench for Shim Pin, HKY40R Wrench for Clamp Screw.

Note 2) The insert photos are only examples. The letters refer to the chipbreaker and the dimension refers to the inscribed circle.

PVJN		External turning, Copying		MP type		Finish									
						Light	Medium	Medium	Medium						
				FP	LP	MP	MP	MP	MP						
				(16)	(16)	(16)	(16)	(16)	(16)	(16)	(16)				
				Right hand tool holder shown.		Medium	Stainless	G Class	CBN						
						Standard	MM	R/L							
						(16)	(16)	(16)	(16)						
Order Number	Stock		Insert Number	Dimensions (mm)						*2		*1			
	R	L		H	B	LF	LH	HF	WF	Shim	Lock Pin	Lock Screw	Stop Ring	Wrench	
PVJNR/L2020K16	●	●	VN ^o A VN ^o G VN ^o M	1604	20	20	125	32	20	25	PV322 (PV321) (PV323)	P11S	HSP05008C	E03	HKY25R
PVJNR/L2525M16	●	●	VN ^o A VN ^o G VN ^o M	1604	25	25	150	38	25	32		P11S	HSP05008C	E03	HKY25R

*1 Clamp Torque (N · m) : HSP05008C=2.5

*2 Please use shim no. PV321 and PV323 with RE0.4mm and RE1.2mm thick inserts. When using inserts, shim should be ordered separately.

DVJN		External turning, Copying		DOUBLE CLAMP type		Finish															
						Light	Medium	Medium	Medium												
				FP	LP	MP	MP	MP	MP												
				(16)	(16)	(16)	(16)	(16)	(16)	(16)	(16)										
				Right hand tool holder shown.		Medium	Stainless	G Class	CBN												
						Standard	MM	R/L													
						(16)	(16)	(16)	(16)												
Order Number	Stock		Insert Number	Dimensions (mm)						Shim		Shim Pin		Clamp Bridge		Spring		Clamp Screw *		Wrench	
	R	L		H	B	LF	LH	HF	WF	DCSVN32	LLP13	DCK3113	DCS2	DC0520T	TKY15F						
DVJNR/L2020K16	●	●	VN ^o A VN ^o G VN ^o M	1604	20	20	125	41	20	25	DCSVN32	LLP13	DCK3113	DCS2	DC0520T	TKY15F					
DVJNR/L2525M16	●	●	VN ^o A VN ^o G VN ^o M	1604	25	25	150	41	25	32	DCSVN32	LLP13	DCK3113	DCS2	DC0520T	TKY15F					

* Clamp Torque (N · m) : DC0520T=3.5

PVJN type inserts > A126 – A129
 DVJN type inserts > A126 – A129
 PCBN & PCD inserts > B046, B047, B066

RECOMMENDED CUTTING CONDITIONS > A074, B020
 SPARE PARTS > N001
 TECHNICAL DATA > P001

EXTERNAL TURNING TOOLS







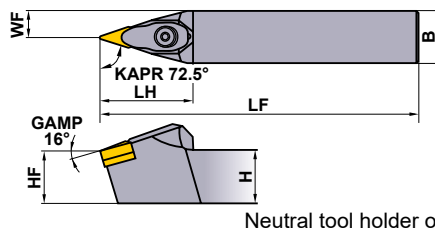
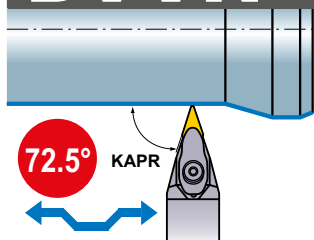

VN^o INSERTS TOOL HOLDERS







DVNN

External turning, **DOUBLE CLAMP** type
Copying



Neutral tool holder only.

Finish	Light	Medium	Medium
FP  (16)	LP  (16)	MP  (16)	MK  (16)
Medium	Stainless	G Class	CBN
Standard  (16)	MM  (16)	R/L  (16)	 (16)

Order Number	Stock	Insert Number	Dimensions (mm)						     						
			H	B	LF	LH	HF	WF	Shim	Shim Pin	Clamp Bridge	Spring	Clamp Screw	Wrench	
DVVNN2020K16	●	VN ^o A VN ^o G VN ^o M	1604	20	20	125	44	20	10	DCSVN32	LLP13	DCK3113	DCS2	DC0520T	TKY15F
DVVNN2525M16	●	VN ^o A VN ^o G VN ^o M	1604	25	25	150	44	25	12.5	DCSVN32	LLP13	DCK3113	DCS2	DC0520T	TKY15F

* Clamp Torque (N · m) : DC0520T=3.5







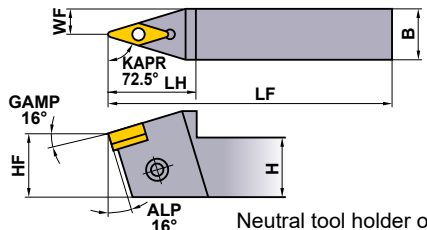
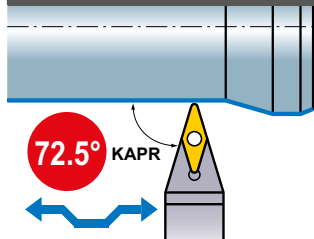

EXTERNAL TURNING TOOLS





PVNN

External turning, **MP** type
Copying



Neutral tool holder only.

Finish	Light	Medium	Medium
FP  (16)	LP  (16)	MP  (16)	MK  (16)
Medium	Stainless	G Class	CBN
Standard  (16)	MM  (16)	R/L  (16)	 (16)

Order Number	Stock	Insert Number	Dimensions (mm)						    					
			H	B	LF	LH	HF	WF	Shim	Lock Pin	Lock Screw	Stop Ring	Wrench	
PVNN2020K16	●	VN ^o A VN ^o G VN ^o M	1604	20	20	125	38	20	10	PV322 (PV321) (PV323)	P11S	HSP05008C	E03	HKY25R
PVNN2525M16	●	VN ^o A VN ^o G VN ^o M	1604	25	25	150	38	25	12.5	PV322 (PV321) (PV323)	P11S	HSP05008C	E03	HKY25R

*1 Clamp Torque (N · m) : HSP05008C=2.5

*2 Please use shim no. PV321 and PV323 with RE0.4mm and RE1.2mm thick inserts. When using inserts, shim should be ordered separately.

Note 1) The insert photos are only examples. The letters refer to the chipbreaker and the dimension refers to the inscribed circle.

DVPN		Facing, Copying								DOUBLE CLAMP type					
		Stock		Insert Number		Dimensions (mm)				Shim	Shim Pin	Clamp Bridge	Spring	Clamp Screw *	Wrench
Order Number	R L	VN:A VN:G VN:M	1604	H	B	LF	LH	HF	WF	DCSVN32	LLP13	DCK3113	DCS2	DC0520T	TKY15F
DVPNR/L2020K16	● ★	VN:A VN:G VN:M	1604	20	20	125	32	20	25	DCSVN32	LLP13	DCK3113	DCS2	DC0520T	TKY15F
DVPNR/L2525M16	● ●	VN:A VN:G VN:M	1604	25	25	150	32	25	32	DCSVN32	LLP13	DCK3113	DCS2	DC0520T	TKY15F

* Clamp Torque (N · m) : DC0520T=3.5

PVPN		Facing, Copying								MP type				
		Stock		Insert Number		Dimensions (mm)				Shim *2	Lock Pin	Lock Screw *1	Stop Ring	Wrench
Order Number	R L	VN:A VN:G VN:M	1604	H	B	LF	LH	HF	WF	PV322 (PV321) (PV323)	P11S	HSP05008C	E03	HKY25R
PVPNR/L2020K16	● ●	VN:A VN:G VN:M	1604	20	20	125	32	20	25	PV322 (PV321) (PV323)	P11S	HSP05008C	E03	HKY25R
PVPNR/L2525M16	● ●	VN:A VN:G VN:M	1604	25	25	150	32	25	32	PV322 (PV321) (PV323)	P11S	HSP05008C	E03	HKY25R

*1 Clamp Torque (N · m) : HSP05008C=2.5

*2 Please use shim no. PV321 and PV323 with RE0.4mm and RE1.2mm thick inserts. When using inserts, shim should be ordered separately.

DVPN type inserts	> A126 – A129
PVPN type inserts	> A126 – A129
PPCBN & PCD inserts	> B046, B047, B066

RECOMMENDED CUTTING CONDITIONS	> A074, B020
SPARE PARTS	> N001
TECHNICAL DATA	> P001

EXTERNAL TURNING TOOLS

WN INSERTS TOOL HOLDERS

PWLN		External turning, Facing								LL type				Light	Medium
										LP	MP				
										 (06)	 (06)	Stainless			
										 (06)					
Order Number	Stock		Insert Number	Dimensions (mm)						*2			*1		
	R	L		H	B	LF	LH	HF	WF	Shim	Shim Pin	Clamp Lever	Clamp Screw	Wrench	
PWLNR/L1616H06	●	●	WNMG	06T3	16	16	100	22	16	20	LLSWN3T3 (LLSWN32)	LLP13	LLCL13	LLCS106	HKY25R
PWLNR/L2020K06	●	●		06T3	20	20	125	22	20	25	LLSWN3T3 (LLSWN32)	LLP13	LLCL13	LLCS106	HKY25R
PWLNR/L2525M06	●	●		06T3	25	25	150	25	25	32	LLSWN3T3 (LLSWN32)	LLP13	LLCL13	LLCS106	HKY25R

*1 Clamp Torque (N · m) : LLCS106=2.2

*2 Please use shim no. LLSWN32 with 4.76mm thick inserts. When using 4.76mm thick inserts, the shim should be ordered separately.

EXTERNAL TURNING TOOLS

C

DWLN		External turning, DOUBLE CLAMP type Facing								Finish				Light	Medium	Medium	
										FP	LP	MP	MK				
										 (08)	 (06,08)	 (06,08)	 (08)	Medium	Medium to Rough	Stainless	CBN
										 (08)	 (08)	 (06,08)	 (08)	Standard	RP	MM	
Order Number	Stock		Insert Number	Dimensions (mm)						*2				*1			
	R	L		H	B	LF	LH	HF	WF	Shim	Shim Pin	Clamp Bridge	Spring	Clamp Screw	Wrench		
DWLNR/L1616H06	●	●	WNMA WNMG WNGA	06T3	16	16	100	25	16	20	LLSWN3T3 (LLSWN32)	LLP23	DCK2211	DCS2	DC0520T	TKY15F	
DWLNR/L2020K06	●	●		06T3	20	20	125	25	20	25	LLSWN3T3 (LLSWN32)	LLP23	DCK2211	DCS2	DC0520T	TKY15F	
DWLNR/L2020K06-T	●	●		0604	20	20	125	25	20	25	LLSWN32	LLP23	DCK2211	DCS2	DC0520T	TKY15F	
DWLNR/L2525M06	●	●		06T3	25	25	150	25	25	32	LLSWN3T3 (LLSWN32)	LLP23	DCK2211	DCS2	DC0520T	TKY15F	
DWLNR/L2525M06-T	●	●		0604	25	25	150	25	25	32	LLSWN32	LLP23	DCK2211	DCS2	DC0520T	TKY15F	
DWLNR/L2020K08	●	●		0804	20	20	125	31	20	25	LLSWN42	LLP14	DCK2613	DCS1	DC0621T	TKY20F	
DWLNR/L2525M08	●	●		0804	25	25	150	31	25	32	LLSWN42	LLP14	DCK2613	DCS1	DC0621T	TKY20F	
DWLNR/L3225P08	●	●		0804	32	25	170	31	32	32	LLSWN42	LLP14	DCK2613	DCS1	DC0621T	TKY20F	

*1 Clamp Torque (N · m) : DC0520T=3.5, DC0621T=5.0

*2 Please use shim no. LLSWN32 with 4.76mm thick inserts. When using 4.76mm thick inserts, the shim should be ordered separately.

Note 1) The insert photos are only examples. The letters refer to the chipbreaker and the dimension refers to the inscribed circle.

● : Inventory maintained.

PWLN type inserts > A130–A133
DWLN type inserts > A130–A134

PCBN inserts > B048
RECOMMENDED CUTTING CONDITIONS > A074, B020

MWLN		External turning, Facing		WP type		Finish				Light				Medium		Medium		
						FP	LP	MP	MK	Medium	Medium to Rough	Stainless	CBN	Standard	RP	MM	(08)	(08)
Order Number	Stock		Insert Number	Dimensions (mm)							Shim Shim Pin		Side Lock Plate Clamp Bridge		Clamp Screw Spring		Wrench	
	R	L		H	B	LF	LH	HF	WF	Shim	Shim Pin	Side Lock Plate	Clamp Bridge	Clamp Screw	Spring	Wrench		
MWLN/L2020K08	●	●	WNMA WNMG WNGA	0804	20	20	125	32	20	25	WPSWN43	CCP34	CPT24	CCK13	SLCS105	MES2	HKY40R	
MWLN/L2525M08	●	●		0804	25	25	150	32	25	32	WPSWN43	CCP34	CPT24	CCK13	SLCS105	MES2	HKY40R	
MWLN/L3225P08	●	●		0804	32	25	170	32	32	32	WPSWN43	CCP34	CPT24	CCK13	SLCS105	MES2	HKY40R	

* Clamp Torque (N • m) : SLCS105=7.0

EXTERNAL TURNING TOOLS

MWLN type inserts > A130 – A134
 PCBN inserts > B048
 RECOMMENDED CUTTING CONDITIONS > A074, B020

SPARE PARTS > N001
 TECHNICAL DATA > P001

EXTERNAL TURNING TOOLS









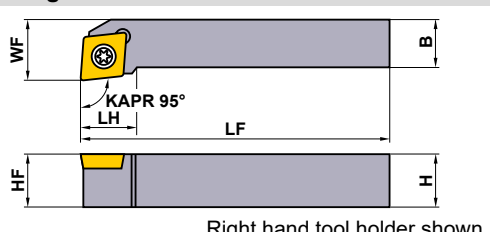
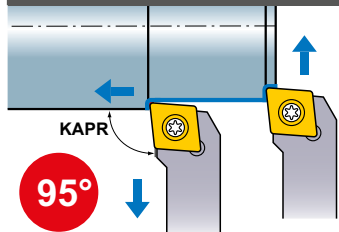

SCLC

External turning, Facing

SP type



Right hand tool holder shown.

Finish	Light	Medium	Stainless
FP  (06,09)	LP  (06,09)	MP  (06,09,12)	FM  (06,09)
Stainless	Stainless	Flat top	PCD/CBN
LM  (06,09)	MM  (06,09,12)	 (06,09,12)	 (06,09,12)

Order Number	Stock		Insert Number	Dimensions (mm)							*1	
	R	L		H	B	LF	LH	HF	WF	Clamp Screw	Wrench	
SCLCR/L0808D06	●	●	CC○B CC○H *2 CC○T CC○W	0602○	8	8	60	8.9	8	10	TS25	TKY08F
SCLCR/L1010E06	●	●		0602○	10	10	70	8.9	10	12	TS25	TKY08F
SCLCR/L1212F09	●	●		09T3○	12	12	80	13.6	12	16	TS43	TKY15F
SCLCR/L1616H12	●	●		1204○	16	16	100	16.7	16	20	TS5	TKY25F

*1 Clamp Torque (N • m) : TS25=1.0, TS43=3.5, TS5=7.5

*2 When using CCGH and CCMH, it is recommended to use TS253 clamp screw.

Note 1) The insert photos are only examples. The letters refer to the chipbreaker and the dimension refers to the inscribed circle.

EXTERNAL TURNING TOOLS

C

● : Inventory maintained.

SCLC type inserts	> A139 – A145
PCBN & PCD inserts	> B051, B052, B067
RECOMMENDED CUTTING CONDITIONS	> A074, B020

SDJC		External turning, Copying		SP type		Finish				Light				Medium				Stainless			
						FP	LP	MP	FM	FP	LP	MP	FM	FP	LP	MP	FM	FP	LP	MP	FM
				 (07,11)				 (07,11)				 (07,11)				 (07,11)					
				Stainless				Stainless				Flat top				PCD/CBN					
				 (07,11)				 (07,11)				 (07,11)				 (07,11)					
				Stainless				Stainless				Flat top				PCD/CBN					
Order Number		Stock	Insert Number		Dimensions (mm)																
		R L			H	B	LF	LH	HF	WF	Shim	Shim Screw	Clamp Screw	Wrench							
SDJCR/L1010E07		● ●	0702		10	10	70	12	10	12	—	—	TS25	TKY08F							
SDJCR/L1212F11		● ●	11T3		12	12	80	18	12	16	—	—	TS43	TKY15F							
SDJCR/L1616H11		● ●	11T3		16	16	100	18	16	20	—	—	TS43	TKY15F							
SDJCR/L2020K11		● ●	11T3		20	20	125	18	20	25	SPSDN32	JSS6	TS406	TKY15R							
SDJCR/L2525M11		● ●	11T3		25	25	150	25	25	32	SPSDN32	JSS6	TS406	TKY15R							

* Clamp Torque (N · m) : TS25=1.0, TS43=3.5

SDNC		External turning, Copying		SP type		Finish				Light				Medium				Stainless			
						FP	LP	MP	FM	FP	LP	MP	FM	FP	LP	MP	FM	FP	LP	MP	FM
				 (07,11)				 (07,11)				 (07,11)				 (07,11)					
				Stainless				Stainless				Flat top				PCD/CBN					
				 (07,11)				 (07,11)				 (07,11)				 (07,11)					
				Stainless				Stainless				Flat top				PCD/CBN					
Order Number		Stock	Insert Number		Dimensions (mm)																
					H	B	LF	HF	WF	Shim	Shim Screw	Clamp Screw	Wrench								
SDNCN0808D07		●	0702		8	8	60	8	4	—	—	TS25	TKY08F								
SDNCN1010E07		●	0702		10	10	70	10	5	—	—	TS25	TKY08F								
SDNCN1212F11		●	11T3		12	12	80	12	6	—	—	TS43	TKY15F								
SDNCN1616H11		●	11T3		16	16	100	16	8	—	—	TS43	TKY15F								
SDNCN2525M11		●	11T3		25	25	150	25	12.5	SPSDN32	JSS6	TS406	TKY15R								

* Clamp Torque (N · m) : TS25=1.0, TS43=3.5

SDJC type inserts > A147 – A152
 SDNC type inserts > A147 – A152
 PCBN & PCD inserts > B054, B055, B068

RECOMMENDED CUTTING CONDITIONS > A074, B020
 SPARE PARTS > N001
 TECHNICAL DATA > P001

EXTERNAL TURNING TOOLS

RC INSERTS TOOL HOLDERS

PRGC

External turning,
Facing, Copying

LL type

Medium

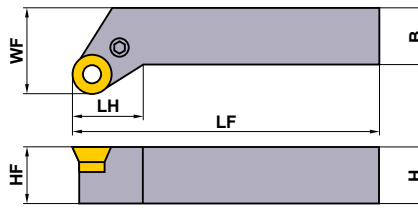
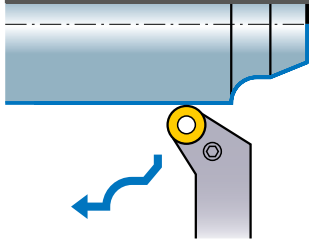

Right hand tool holder shown.



Order Number	Stock		Insert Number	Dimensions (mm)						Shim	Shim Pin	Clamp Lever	Clamp Screw	Wrench	
	R	L		H	B	LF	LH	HF	WF						
PRGCR/L2525M10	●	●	RCMX	1003M0	25	25	150	16.7	25	32	LLSRN103	LLP13	LLCL110	LLCS205	HKY20R
PRGCR/L2525M12	●	●		1204M0	25	25	150	17.5	25	32	LLSRN123	LLP13	LLCL112	LLCS106	HKY25R
PRGCR/L2525M16	●	★		1606M0	25	25	150	19.9	25	32	LLSRN164	LLP24	LLCL116	LLCS306	HKY25R
PRGCR/L3232P20	●	●		2006M0	32	32	170	23.8	32	40	LLSRN204	LLP15	LLCL120	LLCS508	HKY30R

* Clamp Torque (N · m) : LLCS205=1.5, LLCS106=2.2, LLCS306=2.2, LLCS508=3.3

EXTERNAL TURNING TOOLS

PRDC

External turning,
Copying

LL type

Medium

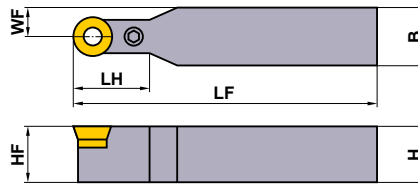
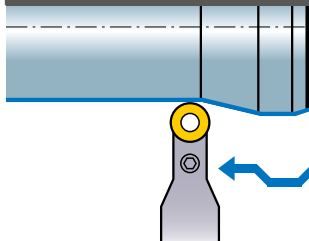

Neutral tool holder only.

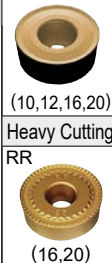

Order Number	Stock		Insert Number	Dimensions (mm)						Shim	Shim Pin	Clamp Lever	Clamp Screw	Wrench	
	R	L		H	B	LF	LH	HF	WF						
PRDCN2020K10	●	●	RCMX	1003M0	20	20	125	23	20	10.0	LLSRN103	LLP13	LLCL110	LLCS205	HKY20R
PRDCN2525M12	●	●		1204M0	25	25	150	24	25	12.5	LLSRN123	LLP13	LLCL112	LLCS106	HKY25R
PRDCN3225P12	●	●		1204M0	32	25	170	24	32	12.5	LLSRN123	LLP13	LLCL112	LLCS106	HKY25R
PRDCN3225P16	●	●		1606M0	32	25	170	28	32	12.5	LLSRN164	LLP24	LLCL116	LLCS306	HKY25R
PRDCN3232P20	●	●		2006M0	32	32	170	33	32	16.0	LLSRN204	LLP15	LLCL120	LLCS508	HKY30R

* Clamp Torque (N · m) : LLCS205=1.5, LLCS106=2.2, LLCS306=2.2, LLCS508=3.3

Note 1) The insert photos are only examples. The letters refer to the chipbreaker and the dimension refers to the inscribed circle.

● : Inventory maintained. ★ : Inventory maintained in Japan.

PRGC type inserts > A154
 PRDC type inserts > A154
 RECOMMENDED CUTTING CONDITIONS > A074, B020

SRGC		External turning, Facing, Copying								SP type			
										Medium – Finish Cutting AZ (08) Medium Standard (06,08)			
Order Number		Stock		Insert Number		Dimensions (mm)				*			
		R L				H	B	LF	LH	HF	WF	Clamp Screw	Wrench
SRGCR/L1616H06		● ●		RCMT 0602		16	16	100	10	16	20	TS25	TKY08F
SRGCR/L1616H08		● ●		RCGT 0803		16	16	100	14.5	16	22	TS3	TKY08F

* Clamp Torque (N • m) : TS25=1.0, TS3=1.0

SRDC		External turning, Copying								SP type			
										Medium – Finish Cutting AZ (08) Medium Standard (06,08)			
Order Number		Stock		Insert Number		Dimensions (mm)				*			
		R L				H	B	LF	LH	HF	WF	Clamp Screw	Wrench
SRDCN1616H06		● ●		RCMT 0602		16	16	100	12	16	8	TS25	TKY08F
SRDCN1616H08		● ●		RCGT 0803		16	16	100	16	16	8	TS3	TKY08F

* Clamp Torque (N • m) : TS25=1.0, TS3=1.0

SRGC type inserts > A154
 SRDC type inserts > A154
 RECOMMENDED CUTTING CONDITIONS > A074, B020

SPARE PARTS > N001
 TECHNICAL DATA > P001

EXTERNAL TURNING TOOLS

SC INSERTS
TOOL HOLDERS

SSSC External turning, Chamfering, Facing **SP type**

Right hand tool holder shown.

Finish	Light	Medium	Stainless
FP (09)	LP (09)	MP (09,12)	FM (09)
Stainless	Stainless	Medium	Flat top
LM (09)	MM (09,12)	Standard (09,12)	(09,12)

Order Number	Stock		Insert Number	Dimensions (mm)						Shim	Shim Screw	Clamp Screw *	Wrench	
	R	L		H	B	LF	LH	HF	WF					
SSSCR/L1212F09	●	●	SCMW SCMT	09T3	12	12	80	15.2	12	13	—	—	TS43	TKY15F
SSSCR/L1616H09	●	●		09T3	16	16	100	15.2	16	17	—	—	TS43	TKY15F
SSSCR/L2020K12	●			1204	20	20	125	18	20	22	SPSSN42	JSS7	TS53	TKY25R
SSSCR/L2525M12	●			1204	25	25	150	25	25	27	SPSSN42	JSS7	TS53	TKY25R

* Clamp Torque (N • m) : TS43=3.5

Note 1) The insert photos are only examples. The letters refer to the chipbreaker and the dimension refers to the inscribed circle.

EXTERNAL TURNING TOOLS

C

● : Inventory maintained.

SSSC type inserts > A155, A156
RECOMMENDED CUTTING CONDITIONS > A074, B020



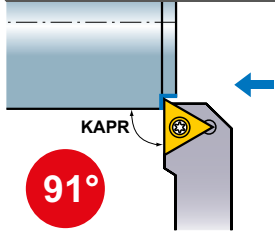



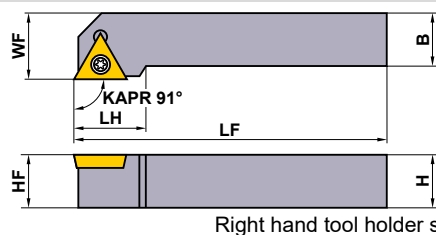

STGC







External turning **SP type**



Right hand tool holder shown.

Finish	Light	Medium	Stainless
FP  (11,16)	LP  (11,16)	MP  (11,13,16)	FM  (11,16)
Stainless	Stainless	Flat top	PCD/CBN
LM  (11,16)	MM  (11,13,16)	 (11,13,16)	 (11,13,16)

Order Number	Stock		Insert Number	Dimensions (mm)										
	R	L		H	B	LF	LH	HF	WF	Shim				
STGCR/L1010E11	●	●	TCGT TCMT TCGW TCMW	1102	10	10	70	13.5	10	12	—	—	TS25	TKY08F
STGCR/L1212F13	●	●		1303	12	12	80	17.6	12	16	—	—	TS3	TKY08F
STGCR/L1616H16	●	●		16T3	16	16	100	20.7	16	20	—	—	TS43	TKY15F
STGCR/L2020K16	●	●		16T3	20	20	125	22.9	20	25	SPSTN32	JSS6	TS406	TKY15R

* Clamp Torque (N • m) : TS25=1.0, TS3=1.0, TS43=3.5

EXTERNAL TURNING TOOLS

VC INSERTS TOOL HOLDERS







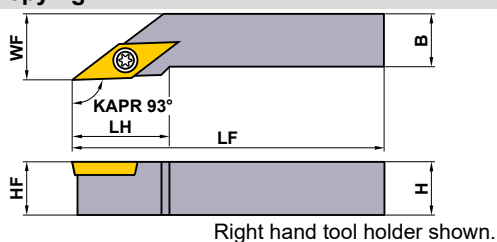
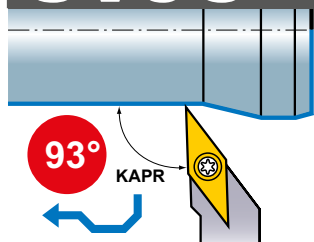

SVJC



External turning, Copying

SP type



Right hand tool holder shown.

Finish	Light	Medium	Stainless
FP  (11,16)	LP  (11,16)	MP  (16)	FM  (11,16)
Stainless	Stainless	Medium	Flat top
LM  (11,16)	MM  (16)	Standard  (11,16)	 (11,16)

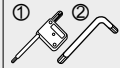
Order Number	Stock		Insert Number	Dimensions (mm)										
	R	L		H	B	LF	LH	HF					WF	Shim
SVJCR/L1010E11	●	●	VCGT VCGW VCMT VCMW	1103	10	10	70	17	10	12	—	—	TS25	①TKY08F
SVJCR/L1616H16	●	●		1604	16	16	100	25	16	20	—	—	TS43	①TKY15F
SVJCR/L2020K16	●	●		1604	20	20	125	40	20	25	SPSVN32	BCP141	TS44	②TKY15R
SVJCR/L2525M16	●	●		1604	25	25	150	40	25	32	SPSVN32	BCP141	TS44	②TKY15R

* Clamp Torque (N · m) : TS25=1.0, TS43=3.5, TS44=3.5

EXTERNAL TURNING TOOLS

C







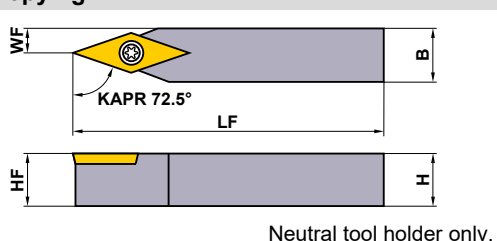
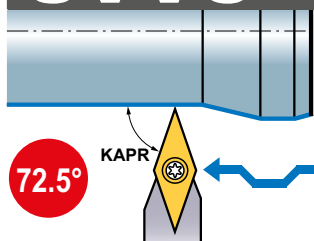

SVVC





External turning, Copying

SP type



Neutral tool holder only.

Finish	Light	Medium	Stainless
FP  (16)	LP  (16)	MP  (16)	FM  (16)
Stainless	Stainless	Medium	Flat top
LM  (16)	MM  (16)	Standard  (16)	 (16)

Order Number	Stock		Insert Number	Dimensions (mm)									
	R	L		H	B	LF	HF	WF					Shim
SVVCN1616H16	●	●	VCGT VCGW VCMT VCMW	1604	16	16	100	16	8	—	—	TS43	①TKY15F
SVVCN2020K16	●	●		1604	20	20	125	20	10	SPSVN32	BCP141	TS44	②TKY15R
SVVCN2525M16	●	●		1604	25	25	150	25	12.5	SPSVN32	BCP141	TS44	②TKY15R





* Clamp Torque (N · m) : TS43=3.5, TS44=3.5

Note 1) The insert photos are only examples. The letters refer to the chipbreaker and the dimension refers to the inscribed circle.

● : Inventory maintained.







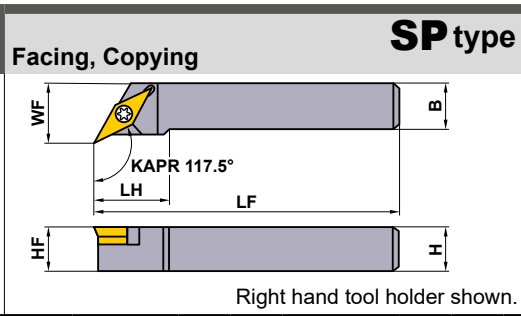
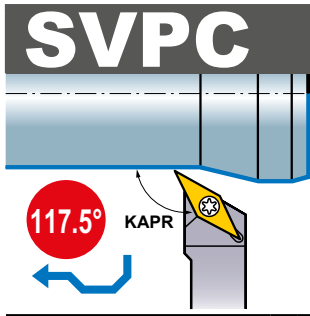

SVJC type inserts > A167–A169
SVVC type inserts > A167–A169

PCBN & PCD inserts > B060, B071
RECOMMENDED CUTTING CONDITIONS > A074, B020

SVPC		Facing, Copying								SP type				
										Finish	Light	Medium	Stainless	
Order Number	Stock		Insert Number		Dimensions (mm)									
	R	L			H	B	LF	LH	HF	WF	Shim	Shim Pin	Clamp Screw *	Wrench
SVPCR/L2020K16	●	●	VC GT VC GW VC MT VC MW	1604	20	20	125	30	20	25	SPSVN32	BCP141	TS44	TKY15R
SVPCR/L2525M16	●	●	VC GT VC GW VC MT VC MW	1604	25	25	150	30	25	32	SPSVN32	BCP141	TS44	TKY15R

* Clamp Torque (N • m) : TS44=3.5

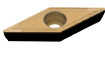

Finish	Light	Medium	Stainless
FP  (16)	LP  (16)	MP  (16)	FM  (16)
Stainless LM  (16)	Stainless MM  (16)	Medium Standard  (16)	Flat top  (16)

EXTERNAL TURNING TOOLS

XC INSERTS TOOL HOLDERS

SXZC

External turning,
Copying

Profile Holder

Finish
SVX

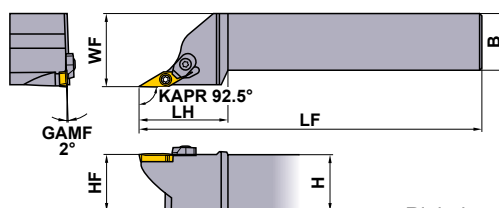
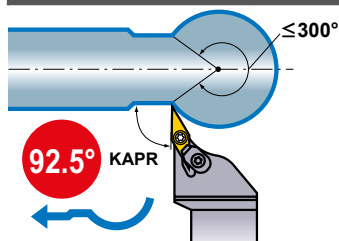

Right hand tool holder shown.



(15)

Order Number	Stock		Insert Number	Dimensions (mm)						* Clamp Screw		* Clamp Bridge		* Spring		* Insert Wrench		* Wrench (Clamp bridge)	
	R	L		H	B	LF	LH	HF	WF	Clamp Screw	Clamp Bridge	Clamp Bridge Screw	Spring	Insert Wrench	Wrench (Clamp bridge)				
SXZCR/L1616H15	●	●	XCMT	1503	16	16	100	35	16	20	TS255	AMS3	AJS3010T10	ASS2	TKY08F	TKY10F			
SXZCR/L2020K15	●	●		1503	20	20	125	35	20	25	TS255	AMS3	AJS3010T10	ASS2	TKY08F	TKY10F			
SXZCR/L2525M15	●	●		1503	25	25	150	40	25	32	TS255	AMS3	AJS3010T10	ASS2	TKF08F	TKF10F			

* Clamp Torque (N · m) : TS255=1.0, AJS3010T10=2.5

EXTERNAL TURNING TOOLS

APPLICABLE RANGE

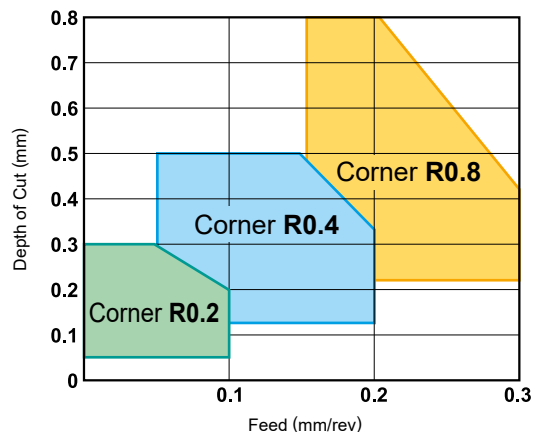

RECOMMENDED CUTTING CONDITIONS

Work Material	Hardness	Grade	Cutting Speed (m/min)
P Mild Steel	≤180HB	UE6020	250 (150–350)
	Carbon Steel, Alloy Steel	150HB–250HB	UE6020
M Stainless Steel	≤200HB	VP15TF	100 (70–120)

Note 1) The above cutting conditions are general guidelines.

Adjustments may be necessary depending on machine rigidity, workpiece geometry and clamping.

Note 2) The insert photos are only examples. The letters refer to the chipbreaker and the dimension refers to the inscribed circle.

● : Inventory maintained.

NOTE

When end face copying

Pay special attention to the following when face copying.

Depth from end face
Up to 10mm

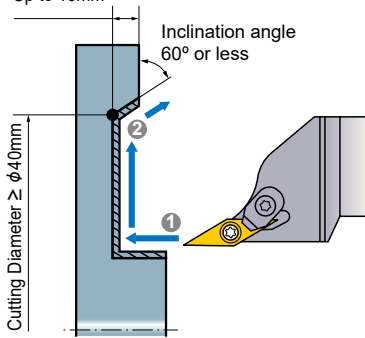

●Machining of an outer diameter (Step ①)

- To prevent burr formation, the depth of cut should be below half the nose radius.

●Machining of an inclination (Step ②)

- To reduce the contact length of chips, the depth of cut should be below half the nose radius.
- To prevent interference between the tool and the workpiece, the cutting diameter should be 40mm or larger, inclination angle 60° or less and depth from the end face up to 10mm.

●When changing inserts

- When indexing the inserts, it is recommended to preset the cutting edge position to maintain machining accuracy.

Not possible

●Machining of V-pulleys

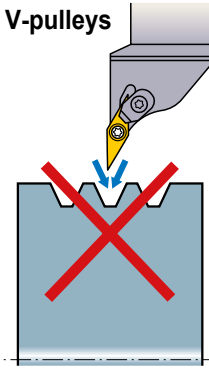

When machining V-pulleys,
use a VNMG insert.



EXTERNAL TURNING TOOLS [FOR ALUMINIUM]

DE INSERTS TOOL HOLDERS

SDJE

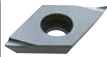

External turning,
Copying

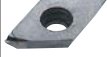
AL type

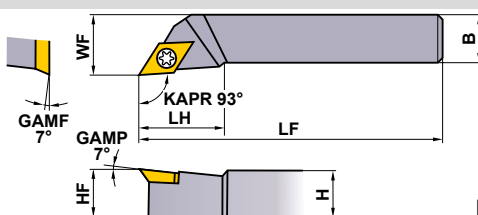
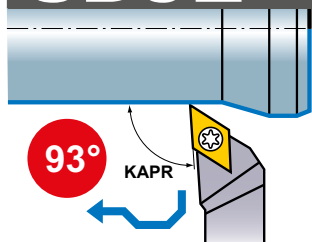
Finish	Medium
R/L-F  (15)	R/L  (15)
PCD	
R/L-F  (15)	



Right hand tool holder shown.

Order Number	Stock		Insert Number	Dimensions (mm)						* 		
	R	L		H	B	LF	LH	HF	WF			Clamp Screw
SDJER/L1616H15	●	●	DEGX	1504	16	16	100	27	16	20	CS451190T	TKY20F
SDJER/L2020K15	●	●		1504	20	20	125	35	20	25	CS451190T	TKY20F
SDJER/L2525M15	●	●		1504	25	25	150	35	25	32	CS451190T	TKY20F



* Clamp Torque (N · m) : CS451190T=5.0

EXTERNAL TURNING TOOLS

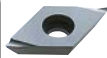

SDNE

External turning,
Copying

AL type

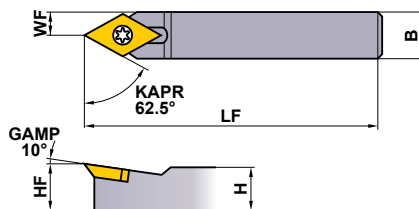
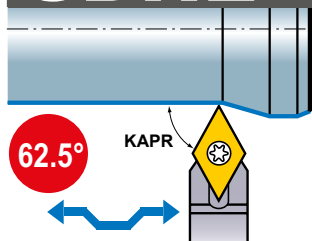
Finish	Medium
R/L-F  (15)	R/L  (15)
PCD	
R/L-F  (15)	



Order Number	Stock		Insert Number	Dimensions (mm)						* 	
	R	L		H	B	LF	HF	WF	Clamp Screw		
SDNEN1616H15	●		DEGX	1504	16	16	100	16	8	CS451190T	TKY20F
SDNEN2020K15	●			1504	20	20	125	20	10	CS451190T	TKY20F
SDNEN2525M15	●			1504	25	25	150	25	12.5	CS451190T	TKY20F

* Clamp Torque (N · m) : CS451190T=5.0

RECOMMENDED CUTTING CONDITIONS

Work Material	Grade	Cutting Speed (m/min)	Feed (mm/rev)	Depth of Cut (mm)
N Aluminium Alloy	HTi10	400	0.05-0.3	0.2-3.0
	MD220	800	0.05-0.3	0.2-0.5

Note 1) The insert photos are only examples. The letters refer to the chipbreaker and the dimension refers to the inscribed circle.

● : Inventory maintained. ★ : Inventory maintained in Japan.

SDJE type inserts > A153
SDNE type inserts > A153
PCD inserts > B073

STGE		External turning								AL type		Medium	PCD
										R/L	R/L		
										Right hand tool holder shown.		 (16)	 (16)
												 (16)	
Order Number	Stock		Insert Number		Dimensions (mm)					*			
	R	L			H	B	LF	LH	HF	WF	Clamp Screw	Wrench	
STGER/L1616H16	★	★	TEGX		1603	16	16	100	22	16	20	FC400890T	TKY10F
STGER/L2020K16	★	★			1603	20	20	125	22	20	25	FC400890T	TKY10F
STGER/L2525M16	★	★			1603	25	25	150	22	25	32	FC400890T	TKY10F

* Clamp Torque (N · m) : FC400890T=2.5

EXTERNAL TURNING TOOLS

STFE		Facing								AL type		Medium	PCD
										R/L	R/L		
										Right hand tool holder shown.		 (16)	 (16)
												 (16)	
Order Number	Stock		Insert Number		Dimensions (mm)					*			
	R	L			H	B	LF	LH	HF	WF	Clamp Screw	Wrench	
STFER/L1616H16	★	★	TEGX		1603	16	16	100	22	16	20	FC400890T	TKY10F
STFER/L2020K16	★	★			1603	20	20	125	22	20	25	FC400890T	TKY10F
STFER/L2525M16	★	★			1603	25	25	150	22	25	32	FC400890T	TKY10F

Note 1) When using inserts with right or left hand chipbreakers, please use left hand inserts for right hand holders and right hand inserts for left hand holders.

* Clamp Torque (N · m) : FC400890T=2.5

RECOMMENDED CUTTING CONDITIONS

Work Material	Grade	Cutting Speed (m/min)	Feed (mm/rev)	Depth of Cut (mm)
N Aluminium Alloy	HTi10	400	0.05-0.3	0.2-3.0
	MD220	800	0.05-0.3	0.2-0.5

STGE type inserts > A161
 STFE type inserts > A161
 PCD inserts > B073

SPARE PARTS > N001
 TECHNICAL DATA > P001

EXTERNAL TURNING TOOLS [FOR ALUMINIUM]

VD INSERTS
TOOL HOLDERS

SVJD

External turning,
Copying

AL type

Finish

R/L

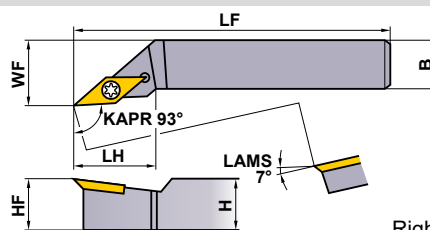
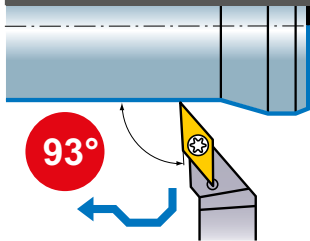

Right hand tool holder shown.



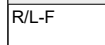

(16)

PCD



(16)

Order Number	Stock		Insert Number	Dimensions (mm)						* 		
	R	L		H	B	LF	LH	HF	WF	Clamp Screw	Wrench 	
SVJDR/L1616H16	★	★	VDGX	1603	16	16	100	30	16	20	FC400890T	TKY10F
SVJDR/L2020K16	★	★		1603	20	20	125	30	20	25	FC400890T	TKY10F
SVJDR/L2525M16	★	★		1603	25	25	150	30	25	32	FC400890T	TKY10F

* Clamp Torque (N · m) : FC400890T=2.5

EXTERNAL TURNING TOOLS

RECOMMENDED CUTTING CONDITIONS

Work Material	Grade	Cutting Speed (m/min)	Feed (mm/rev)	Depth of Cut (mm)
N Aluminium Alloy	HTi10	400	0.05-0.3	0.2-3.0
	MD220	800	0.05-0.3	0.2-0.5

Note 1) The insert photos are only examples. The letters refer to the chipbreaker and the dimension refers to the inscribed circle.

● : Inventory maintained. ★ : Inventory maintained in Japan.

SVJD type inserts > A170
PCD inserts > B074

TL HOLDER

HOLDER

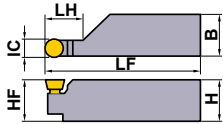
Geometry	Revised order number	Conventional order number	Stock	Insert Number	Dimensions (mm)					
					IC	H	B	HF	LF	LH
TLHR (External turning, Copying) 	TLHR2020K5	TLHR2020K5	●	RTG05A	5	20	20	20	125	16
	TLHR2020K6	TLHR2020K6	●	RTG06A	6	20	20	20	125	16
	TLHR2525M7	TLHR2525M7	●	RTG07A	7	25	25	25	150	20
	TLHR3225P10	TLHR54P10	●	RTG10A	10	32	25	32	170	25

INSERTS

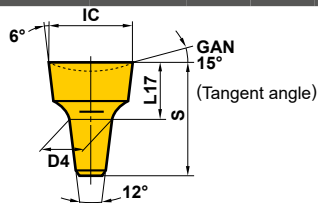

Order Number	Stock		Dimensions (mm)			
	Carbide		IC	S	D4	L17
	UTi20T	HTi10				
RTG05A	●	●	5	7.5	2.5	3.5
RTG06A	●	●	6	7.5	3.5	3.5
RTG07A	●		7	11	3.5	5
RTG08A	●	●	8	11	4.5	5
RTG10A	●	●	10	14	5.5	6.5

INSERT SEAT LOCATION

When manufacturing a special tool holder, please machine the insert seat in accordance to the drawing.

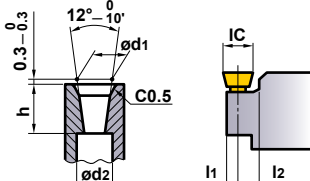
Insert Seat Dimensions	Insert Diameter IC	Dimensions (mm)					Taper Diameter
		h	d1	d2	l1	l2	
	5	4	2.5	1.9	1.85	3.2	1.5
	6	4	3.5	2.9	2.35	3.7	2.5
	7	6	3.5	2.5	2.75	4.3	2.1
	8	6	4.5	3.5	3.25	4.8	3.1
	10	7.5	5.5	4.2	4.15	5.9	3.8
	12	7.5	7.5	6.2	5.15	6.9	5.8

Memo

A series of horizontal dashed lines for writing, spanning the width of the page.

Memo

A series of horizontal dashed lines for writing, spanning the width of the page.

HOW TO READ THE STANDARD OF SMALL TOOLS

●How this section page is organised

- ①Organised according to the cutting mode of small tools.
(Refer to the inside title on the next page.)
- ②Shown as Turning → External Grooving → External Cutting Off → Threading → Boring.

TYPE OF TOOL HOLDER

Indicates the first four letters of the order number, as well as cutting applications.

APPLICATION

PRODUCT SECTION

SMALL TOOLS

EXTERNAL FRONT TURNING

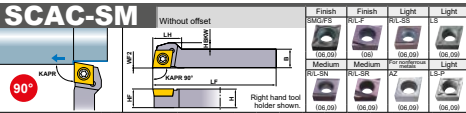

Order Number	Stock	Insert Number	Dimensions (mm)								Clamp Screw	Wrench
			H	B	LF	LH	RBKW	HF	WF2	WF1		
SCACRL0809K06-SM	●	0602	8	8	125	11	1.6	8	0	TS254	TKY09R	
SCACRL1010K06-SM	●	0602	10	10	125	—	—	10	0	TS254	TKY09R	
SCACRL1010K09-SM	●	09T3	10	10	125	16	3.5	10	0	TS43	TKY15R	
SCACRL1212M09-SM	●	09T3	12	12	150	14	1.5	12	0	TS43	TKY15R	
SCACRL1616M09-SM	●	09T3	16	16	150	—	—	16	0	TS43	TKY15R	

* Clamp Torque (N·m) : TS254=1.0, TS43=3.5

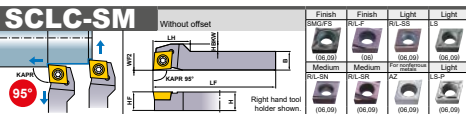

Order Number	Stock	Insert Number	Dimensions (mm)								Clamp Screw	Wrench
			H	B	LF	LH	RBKW	HF	WF2	WF1		
SCLCLR0809K06-SM	●	0602	8	8	125	11	2.1	8	0	TS254	TKY09R	
SCLCLR1010K06-SM	●	0602	10	10	125	—	—	10	0	TS254	TKY09R	
SCLCLR1010K09-SM	●	09T3	10	10	125	20	4	10	0	TS43	TKY15R	
SCLCLR1212M09-SM	●	09T3	12	12	150	18	2	12	0	TS43	TKY15R	
SCLCLR1616M09-SM	●	09T3	16	16	150	—	—	16	0	TS43	TKY15R	

* Clamp Torque (N·m) : TS254=1.0, TS43=3.5

Note 1) The insert photos are only examples. The letters refer to the chip breaker and the dimension refers to the inscribed circle.
Note 2) Dimensions shown for insert corner RE 0.2.

● Inventory maintained. ★ Inventory maintained in Japan.

SCAC-SM type inserts	> A139 - A146
SCLC-SM type inserts	> A139 - A146
CBN & PCD inserts	> B051, B052, B067

FIGURE SHOWING THE TOOLING APPLICATION Uses illustrations and arrows to depict the available machining applications such as external turning, copying, facing, chamfering, threading, and grooving together with cutting edge lead angles.

GEOMETRY

CHIPBREAKER BY CUTTING APPLICATION

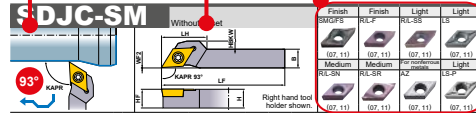

Order Number	Stock	Insert Number	Dimensions (mm)								Clamp Screw	Wrench
			H	B	LF	LH	RBKW	HF	WF2	WF1		
SDJCLR0809K07-SM	●	0702	8	8	125	16	2	8	0	TS254	TKY09R	
SDJCLR1010K07-SM	●	0702	10	10	125	—	—	10	0	TS254	TKY09R	
SDJCLR1010K11-SM	●	11T3	10	10	125	24	4	10	0	TS43	TKY15R	
SDJCLR1212M11-SM	●	11T3	12	12	150	22	2	12	0	TS43	TKY15R	
SDJCLR1616M11-SM	●	11T3	16	16	150	—	—	16	0	TS43	TKY15R	

* Clamp Torque (N·m) : TS254=1.0, TS43=3.5

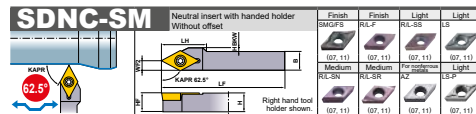

Order Number	Stock	Insert Number	Dimensions (mm)								Clamp Screw	Wrench
			H	B	LF	LH	RBKW	HF	WF2	WF1		
SDNCLR0809K07-SM	●	0702	8	8	125	—	—	8	3	TS254	TKY09R	
SDNCLR1010K07-SM	●	0702	10	10	125	—	—	10	3	TS254	TKY09R	
SDNCLR1010K11-SM	●	11T3	10	10	125	24	2	10	5	TS43	TKY15R	
SDNCLR1212M11-SM	●	11T3	12	12	150	—	—	12	5	TS43	TKY15R	
SDNCLR1616M11-SM	●	11T3	16	16	150	—	—	16	5	TS43	TKY15R	

* Clamp Torque (N·m) : TS254=1.0, TS43=3.5

RECOMMENDED CUTTING CONDITIONS

Work Material	Hardness	Grade	Cutting Speed (m/min)	Feed (mm/rev)
P Carbon Steel / Alloy Steel	180HB~280HB	MS6015/VP15TF	100 (50~150)	0.08 (0.01~0.15)
		MS6015	110 (30~180)	0.08 (0.01~0.15)
		NX2555	150 (50~250)	0.08 (0.01~0.15)
M Free Cutting Steel	—	VP15TF/MP9005/MP9015	80 (50~120)	0.08 (0.02~0.1)
		MS9025	100 (50~180)	0.09 (0.01~0.15)
N Non-Ferrous Metal	—	HT10/MT9005	150 (70~230)	0.09 (0.03~0.15)
		MT9005	60 (40~80)	0.08 (0.04~0.12)
S Heat Resistant Alloy	—	MP9015/MS9025	50 (20~75)	0.08 (0.04~0.12)

SDJC-SM type inserts > A147 - A162
SDNC-SM type inserts > A147 - A162
CBN & PCD inserts > B054, B055, B066

SPARE PARTS > N001
TECHNICAL DATA > P001

LEGEND FOR STOCK STATUS MARK

Is shown on the left hand page of each double-page spread.

PRODUCT STANDARDS

Indicates order numbers, stock status (per right/left hand), applicable inserts, dimensions, and spare parts.

REFERENCE PAGE FOR APPLICABLE INSERTS

Indicates reference pages giving details of inserts that are applicable to the product.

PAGE REFERENCE

· SPARE PARTS
· TECHNICAL DATA
Indicates reference pages, including the above, on the right hand page of each double-page spread.

RECOMMENDED CUTTING CONDITIONS

For each work material classification, indicates recommended cutting conditions according to the ISO categories for cutting grades, P, M, K and N.

TURNING TOOLS

SMALL TOOLS

OUTLINE OF SMALL TOOLS	D002
CLASSIFICATION	D006

STANDARD OF SMALL TOOLS

EXTERNAL FRONT TURNING

SCAC-SM	D010
SCLC-SM	D010
SDJC-SM	D011
SDNC-SM	D011
SVLP-SM	D012
SVJB-SM	D012
SVJC-SM	D013
SVPP-SM	D013
SVVB-SM	D013

EXTERNAL BACK TURNING

BTAH	D014
CTBH	D015
BTVH	D016

EXTERNAL GROOVING

GTAH	D018
GTBH	D018
GTCH	D018

EXTERNAL CUTTING OFF

CTAH	D020
CTAH-S	D020
CTBH	D022

EXTERNAL THREADING

TTAH	D024
------------	------

EXTERNAL FRONT TURNING, COPYING, FACING

SH	D026
----------	------

*Alphabetical order index

D014 BTAH
 D014 BTAT (INSERTS)
 D015 BTBT (INSERTS)
 D016 BTVH
 D016 BTVT (INSERTS)
 D020 CTAH
 D020 CTAH-S
 D021 CTAT (INSERTS)
 D015 CTBH
 D022 CTBT (INSERTS)

D018 GTAH
 D018 GTAT (INSERTS)
 D018 GTBH
 D018 GTBT (INSERTS)
 D018 GTCH
 D018 GTCT (INSERTS)
 D010 SCAC-SM
 D010 SCLC-SM
 D011 SDJC-SM
 D011 SDNC-SM

D012 SVJB-SM
 D013 SVJC-SM
 D012 SVLP-SM
 D013 SVPP-SM
 D013 SVVB-SM
 D024 TTAH
 D024 TTAT (INSERTS)

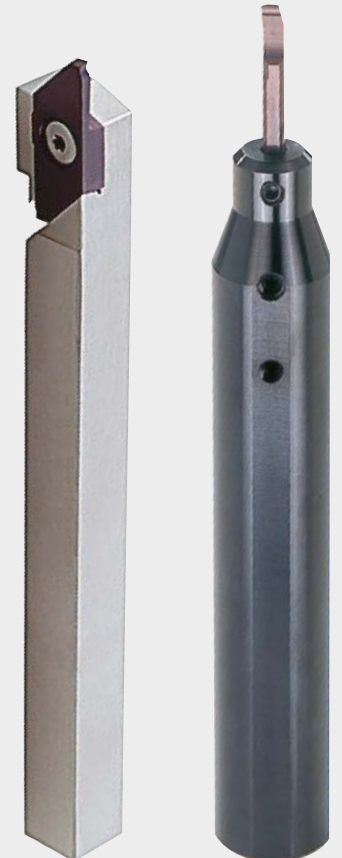

OUTLINE OF SMALL TOOLS

TOOLS FOR GANG TYPE AUTOMATIC LATHES (FOR EXTERNAL TURNING AND BORING)

SMALL TOOLS

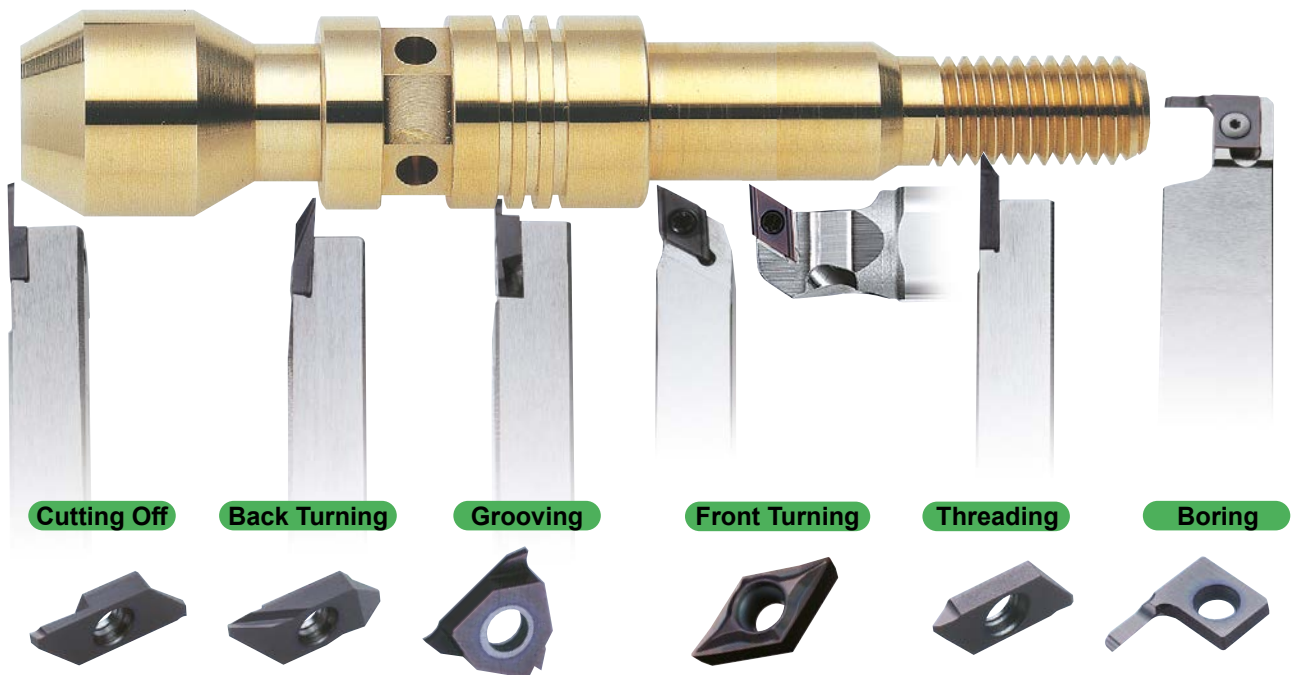

PVD Coated Cemented Carbide Grade for Carbon Steel

MS6015

Ideal for turning pure iron, carbon and free cutting steels, and for achieving good surface finishes plus excellent dimensional accuracy.

	MS6015	Conventional
Coating	TiCN multilayer	TiAlN
Hardness (HV)	3,000	2,800
Wear Coefficient (Carbon Steel)	Low	High
Base Material Hardness (HRA)	92.0	92.0
T.R.S (GPa)	2.0	2.0

Ti-C-N Multilayer Coating

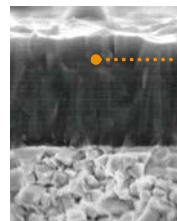

Superior wear and welding resistance and demonstrating the best possible results for machining carbon steel.

PVD Coated Grade for High Precision and Small Parts Machining

MS9025 NEW

Effective reduction of notch wear with a balance of wear and fracture resistance.

Improved Cemented Carbide

Thermal conductivity has been improved by optimising the grain size and therefore reducing the boundary contact between the WC particles. This optimisation reduces the temperature of the cutting edge during machining.

MS9025

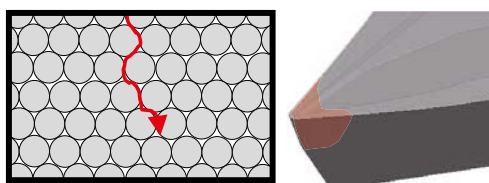

Reducing the cutting edge temperature by improved thermal conductivity.

Conventional

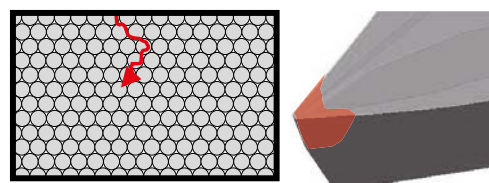

Higher cutting edge temperatures due to more particle boundary contact.

● Moulded breaker insert

Nose radii designed with minus tolerance

- Suitable for small parts applications that often require minus tolerance dimensions.
- The order number is shown with the letter "M" that indicates minus tolerance. ex. DCGT11T301M-FS
- The radius value is printed on the side of the insert label for easy recognition.

A combination of a curved cutting edge and the protrusion type breaker promotes efficient chip breaking.

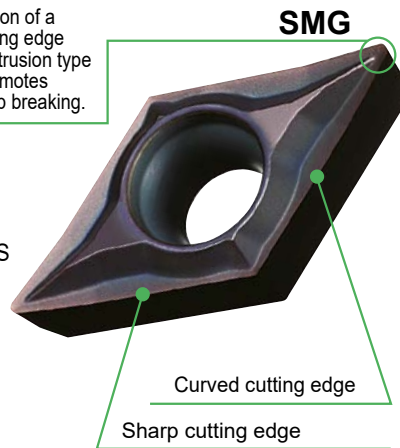

FS

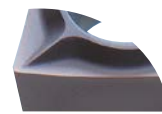

FS-P



LS

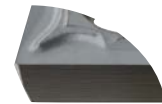

LS-P



● Tolerance Corner R

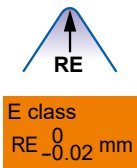

The letter "M" insert
 $RE \begin{matrix} 0 \\ -0.05 \end{matrix} \text{ mm}$
 (Conventional G-class insert
 $RE \pm 0.10 \text{ mm}$)

● Cutting Off

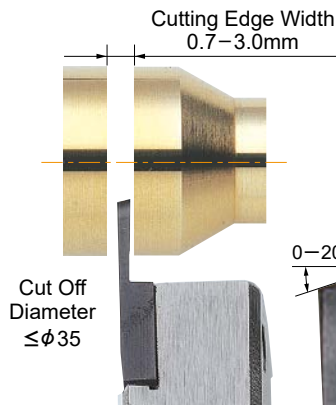

● Back Turning

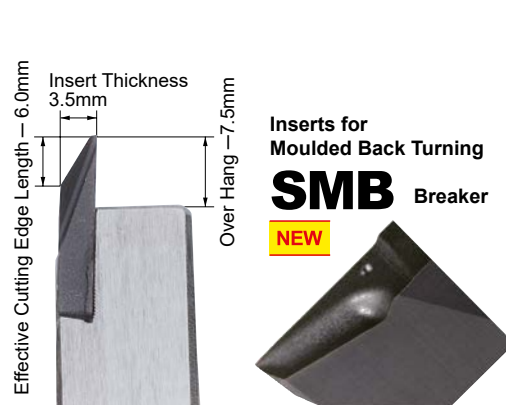

● Threading

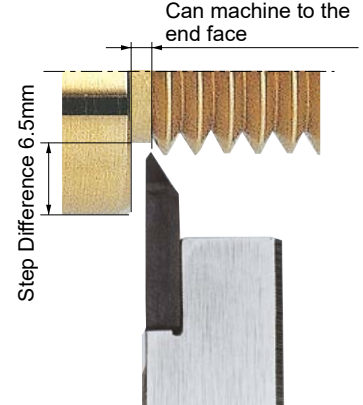

● Back Clamping Mechanism

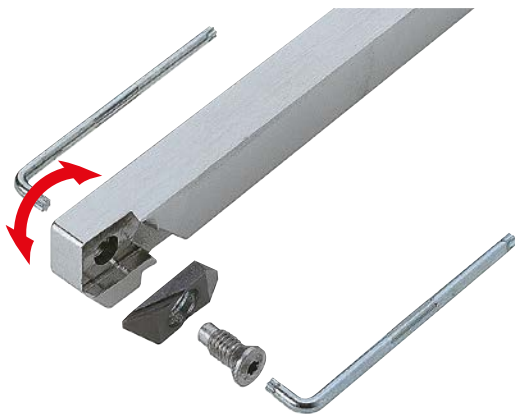

Screw designed for front and back clamping.

● Grooving

- 3 cutting edges
- Groove width 0.3-3.0mm
- Traversing possible

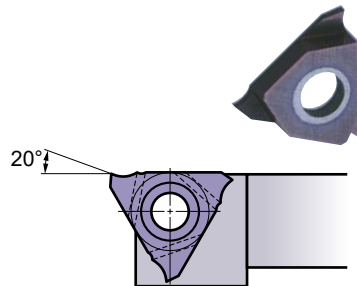

● Front Turning

- ISO E class accuracy inserts
- A wide variety of small corner R inserts
- Rake angle 30°

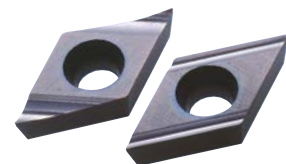

Tools for an extensive range of small parts machining

External Turning	Tools for front turning, back turning, grooving, threading and cutting off
Internal Turning	Tools for boring, internal grooving and internal threading
Drilling	Drills
End Milling	End Mills

Indexable inserts developed under the concept of "high quality, high efficiency and long tool life."

High Quality	E class tolerance, sharp cutting edge, high accuracy small corner R, smooth surface finish
Long Tool Life	PVD coating MS6015/VP15TF/MP9005/MP9015
High Efficiency	Regrinding not necessary due to the employment of indexable inserts. A wide variety of top cutting edge geometries

Tools for CNC automatic and small lathes

Types of Tool Posts	Gang type, turret type, cam type (radial pattern type)
Tool Sizes	Square shank: 8–16 mm Round shank : less than $\phi 25.4$



TOOLS FOR CAM TYPE AUTOMATIC LATHES

- The most suitable for the use with cam type automatic lathes (radial pattern tool posts)
- The most suitable for machining of small parts with work diameter 5mm or smaller
- Single holder for front turning, back turning, grooving, threading and cutting off operations



INTERNAL TURNING TOOLS

Solid type **MICRO-MINI TWIN Boring Bars**

Minimum cutting diameter $\phi 2.2$ -

Boring
Grooving
Threading



Round Shank

Square Shank

MICRO-DEX Boring Bars

Minimum cutting diameter $\phi 5.0$ -



Minimum cutting diameter $\phi 10.0$

DIMPLE BAR

(Please see the Boring Bar section for these tools.)

DRILLING TOOLS

Violet Coated Precision Drills

VAPDS/VAPDM (General)
(For stainless steel)

VAPDSCB
(For counter boring)

Solid Carbide Drill

MVS/DWAE

Solid Carbide Flat Bottom Drills

MFE

Solid Carbide Drills for
Centreing and Chamfering

DLE

Micro Solid Carbide Drills

MSE Drills

MSE/MSP (Centre Drills)



Solid Gun Drill

Micro Solid Carbide Gun Drill
with through coolant holes

MGS



END MILLING TOOLS

Solid Carbide End Mill

MSTAR / MSTAR Plus End Mill Series

Vibration Control End Mills for
Machining Difficult-to-Cut Materials

SMART MIRACLE End Mill Series



D

SMALL TOOLS

CLASSIFICATION OF EXTERNAL TURNING TOOLS

GANG TYPE TOOL POSTS

● FRONT TURNING

Name of Tool Holder	Shank Size (mm) (H x W x L)	Geometry
SCAC-SM ↻ D010	8 x 8 x 125 10 x 10 x 125 12 x 12 x 150 16 x 16 x 150	90° KAPR
SCLC-SM ↻ D010	8 x 8 x 125 10 x 10 x 125 12 x 12 x 150 16 x 16 x 150	95° KAPR
SDJC-SM ↻ D011	8 x 8 x 125 10 x 10 x 125 12 x 12 x 150 16 x 16 x 150	93° KAPR
SDNC-SM ↻ D011	8 x 8 x 125 10 x 10 x 125 12 x 12 x 150 16 x 16 x 150	62.5° KAPR
SVLP-SM ↻ D012	10 x 10 x 125 12 x 12 x 150 16 x 16 x 150	95° KAPR
SVJB-SM ↻ D012	10 x 10 x 125 12 x 12 x 150 16 x 16 x 150	93° KAPR
SVJC-SM ↻ D013	10 x 10 x 120 12 x 12 x 120 16 x 16 x 120	93° KAPR
SVPP-SM ↻ D013	10 x 10 x 125 12 x 12 x 150 16 x 16 x 150	117.5° KAPR
SVVB-SM ↻ D013	10 x 10 x 125 12 x 12 x 150 16 x 16 x 150	72.5° KAPR

● BACK TURNING

Name of Tool Holder	Shank Size (mm) (H x W x L)	Geometry
BTAH (Insert Size 2.8, 3.5, 5.0mm) ↻ D014	8 x 10 x 120 10 x 10 x 120 12 x 12 x 120 16 x 16 x 120	
CTBH (Insert Size 4.5, 6.0mm) ↻ D015	10 x 10 x 120 12 x 12 x 120 16 x 16 x 120	
BTVH (Insert Size 7.5mm) ↻ D016	10 x 10 x 120 12 x 12 x 120 16 x 16 x 120	53° KAPR

● THREADING

Name of Tool Holder	Shank Size (mm) (H x W x L)	Geometry
TTAH ↻ D024	8 x 10 x 120 10 x 10 x 120 12 x 12 x 120 16 x 16 x 120	

● GROOVING

Name of Tool Holder	Shank Size (mm) (H x W x L)	Geometry
GTAH (Groove Width 0.3–3.0mm) ↻ D018	8 x 8 x 80 8 x 8 x 120 10 x 10 x 80 10 x 10 x 120 12 x 12 x 80 12 x 12 x 120 16 x 16 x 120	U Type ↑ E Type ↑ VT Type
GTBH (Groove Width 1.45–3.0mm) ↻ D018	10 x 10 x 80 10 x 10 x 120 12 x 12 x 120 16 x 16 x 120	U Type ↑ E Type ↑ VT Type
GTCH (Groove Width 2.5–3.0mm) ↻ D018	10 x 10 x 80 10 x 10 x 120	U Type ↑ E Type ↑ VT Type

● CUTTING OFF

Name of Tool Holder	Shank Size (mm) (H x W x L)	Geometry
CTAH (Max. Cut Off Diameter 12mm) ↻ D020	8 x 10 x 120 10 x 10 x 120 12 x 12 x 120 16 x 16 x 120	
CTAH-S (Max. Cut Off Diameter 12mm) ↻ D020	10 x 10 x 80	
CTBH (Max. Cut Off Diameter 16mm) ↻ D022	10 x 10 x 120 12 x 12 x 120 16 x 16 x 120	

OPPOSITE TOOL POSTS

● DIMPLE SLEEVE HOLDER

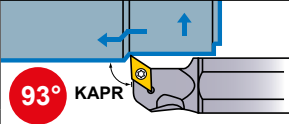



Name of Tool Holder	Shank Size (mm) (Shank Dia. x L)	Geometry
SH (Front Turning, Copying, Facing)	$\phi 15.875 \times 100$ $\phi 19.05 \times 125$ $\phi 20 \times 125$ $\phi 22 \times 125$ $\phi 25.4 \times 150$	 93° KAPR
➔ D026		

● THREADING

Name of Tool Holder	Shank Size (mm) (H x W x L)	Geometry
MMT	$12 \times 12 \times 100$ $16 \times 16 \times 100$ $20 \times 20 \times 125$ $25 \times 25 \times 150$ $32 \times 32 \times 170$	
➔ G019		

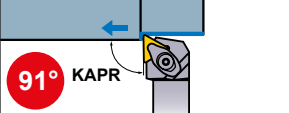
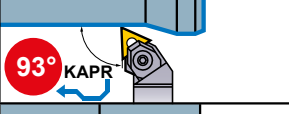
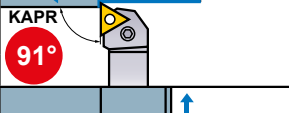
TURRET TYPE TOOL POSTS

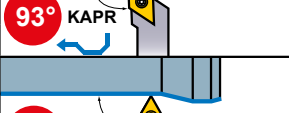
● FRONT TURNING

Name of Tool Holder	Shank Size (mm) (H x W x L)	Geometry
DTGN	$16 \times 16 \times 100$ $20 \times 20 \times 125$ $25 \times 25 \times 150$	 91° KAPR
➔ C016		
MTJN	$20 \times 20 \times 125$ $25 \times 25 \times 150$	 93° KAPR
➔ C017		
PTGN	$10 \times 10 \times 70$ $12 \times 12 \times 80$ $16 \times 16 \times 100$ $20 \times 20 \times 125$ $25 \times 25 \times 150$	 91° KAPR
➔ C016		
SCLC	$8 \times 8 \times 60$ $10 \times 10 \times 70$ $12 \times 12 \times 80$ $16 \times 16 \times 100$	 95° KAPR
➔ C024		
SDJC	$10 \times 10 \times 70$ $12 \times 12 \times 80$ $16 \times 16 \times 100$	 93° KAPR
➔ C025		
SDNC	$8 \times 8 \times 60$ $10 \times 10 \times 70$ $12 \times 12 \times 80$ $16 \times 16 \times 100$	 62.5° KAPR
➔ C025		



CLASSIFICATION OF INTERNAL TURNING TOOLS (FOR GENERAL USE)

D
SMALL TOOLS

Product Name	Holder	Product Name	Holder
MICRO-MINI TWIN Boring Bars (Solid Carbide) E021, E022	CB CR  Min. Cutting Diameter : 2.2mm	DIMPLE BAR (Steel Shank) (Carbide Shank) E010	FSDUC FSDUC-E  Min. Cutting Diameter : 14mm
MICRO-MINI Boring Bars (Solid Carbide) E024	COFR-BLS  Min. Cutting Diameter : 3.2mm	DIMPLE BAR (Steel Shank) (Carbide Shank) E011	FSDQC FSDQC-E  Min. Cutting Diameter : 13mm
MICRO-DEX Boring Bars (Carbide Shank) E018	SCLC  Min. Cutting Diameter : 5mm	DIMPLE BAR (Steel Shank) (Carbide Shank) E009	FSTUP FSTUP-E  Min. Cutting Diameter : 10mm
MICRO-DEX Boring Bars (Carbide Shank) E019	STUC  Min. Cutting Diameter : 8mm	DIMPLE BAR (Steel Shank) E013	FSVUB/C  Min. Cutting Diameter : 16mm
MICRO-DEX Boring Bars (Carbide Shank) E018	SWUB  Min. Cutting Diameter : 6mm	DIMPLE BAR (Steel Shank) E013	FSVPB/C  Min. Cutting Diameter : 16mm
F type Bars (Steel Shank) E029	FSWL1  Min. Cutting Diameter : 5.8mm	DIMPLE BAR (Steel Shank) E014	FSVJB/C  Min. Cutting Diameter : 16mm
F type Bars (Carbide Shank) E029	FSWL2  Min. Cutting Diameter : 5.8mm	DIMPLE BAR (Steel Shank) (Carbide Shank) E012	FSWUB/P FSWUB/P-E  Min. Cutting Diameter : 10mm
DIMPLE BAR (Steel Shank) (Carbide Shank) E007, E008	FSCLC/P FSCLC/P-E  Min. Cutting Diameter : 10mm		

CLASSIFICATION OF INTERNAL TURNING TOOLS (GROOVING/THREADING) (END MILLING/DRILLING)





FOR GROOVING AND THREADING

Product Name	Holder
MICRO-MINI TWIN Boring Bars (Solid Type) ➔ F127	CG TYPE (Grooving)  Min. Cutting Diameter : 3mm
MICRO-MINI TWIN Boring Bars (Solid Type) ➔ G031	CT TYPE (Threading)  Min. Cutting Diameter : 3mm

END MILLS

Solid Carbide End Mill Series	➔ I026
HSS End Mill Series	➔ I034

DRILLS

Product Name	Series Title
Solid Carbide Drills ➔ M036	MVS series 
Solid Carbide Drills ➔ M020	DWAE series 
Centre Drills ➔ M012	DLE series 
Flat Bottom Drills ➔ M018	MFE series 

Solid Carbide Drill Series ➔ M004

Solid Gun Drill Series ➔ M079

HSS Drill Series ➔ M005

EXTERNAL FRONT TURNING

SCAC-SM

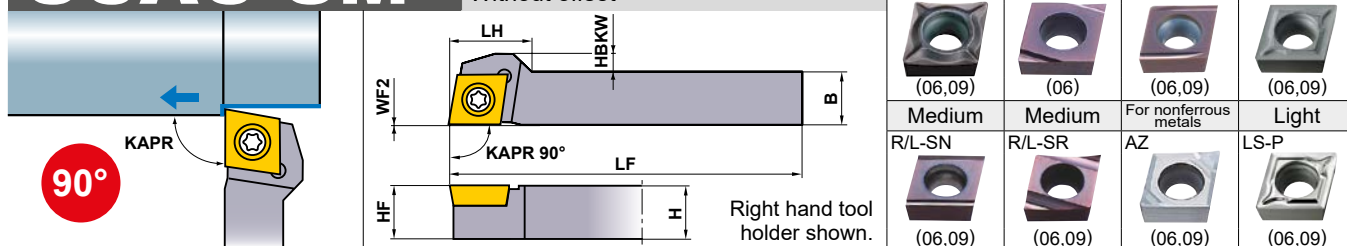

Finish	Finish	Light	Light
SMG/FS (06,09)	R/L-F (06)	R/L-SS (06,09)	LS (06,09)
Medium R/L-SN (06,09)	Medium R/L-SR (06,09)	For nonferrous metals AZ (06,09)	Light LS-P (06,09)

Order Number	Stock		Insert Number	Dimensions (mm)							*		
	R	L		H	B	LF	LH	HBKW	HF	WF2	Clamp Screw	Wrench	
SCACR/L0808K06-SM	●	★	CC●B CC●H CC●T CC●W	0602○○	8	8	125	11	1.6	8	0	TS254	TKY08R
SCACR/L1010K06-SM	●	★		0602○○	10	10	125	—	—	10	0	TS254	TKY08R
SCACR/L1010K09-SM	●	★		09T3○○	10	10	125	16	3.5	10	0	TS43	TKY15R
SCACR/L1212M09-SM	●	★		09T3○○	12	12	150	14	1.5	12	0	TS43	TKY15R
SCACR/L1616M09-SM	●	★		09T3○○	16	16	150	—	—	16	0	TS43	TKY15R

* Clamp Torque (N · m) : TS254=1.0, TS43=3.5

SCLC-SM

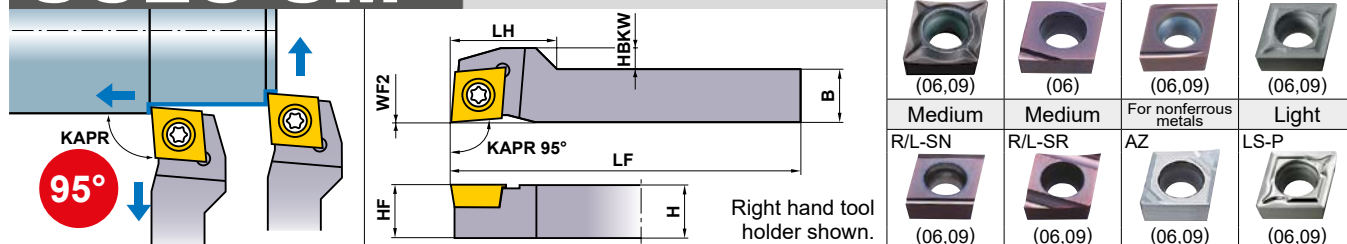

Finish	Finish	Light	Light
SMG/FS (06,09)	R/L-F (06)	R/L-SS (06,09)	LS (06,09)
Medium R/L-SN (06,09)	Medium R/L-SR (06,09)	For nonferrous metals AZ (06,09)	Light LS-P (06,09)

Order Number	Stock		Insert Number	Dimensions (mm)							*		
	R	L		H	B	LF	LH	HBKW	HF	WF2	Clamp Screw	Wrench	
SCLCR/L0808K06-SM	●	★	CC●B CC●H CC●T CC●W	0602○○	8	8	125	11	2.1	8	0	TS254	TKY08R
SCLCR/L1010K06-SM	●	★		0602○○	10	10	125	—	—	10	0	TS254	TKY08R
SCLCR/L1010K09-SM	●	★		09T3○○	10	10	125	20	4	10	0	TS43	TKY15R
SCLCR/L1212M09-SM	●	★		09T3○○	12	12	150	18	2	12	0	TS43	TKY15R
SCLCR/L1616M09-SM	●	★		09T3○○	16	16	150	—	—	16	0	TS43	TKY15R

* Clamp Torque (N · m) : TS254=1.0, TS43=3.5

Note 1) The insert photos are only examples. The letters refer to the chipbreaker and the dimension refers to the inscribed circle.

Note 2) Dimensions shown for insert corner RE 0.2.

SMALL TOOLS

D

● : Inventory maintained. ★ : Inventory maintained in Japan.

SCAC-SM type inserts	> A139—A145
SCLC-SM type inserts	> A139—A145
CBN & PCD inserts	> B051, B052, B067

Order Number		Stock		Insert Number		Dimensions (mm)					*		
						H	B	LF	LH	HBKW	HF	WF2	Clamp Screw
SDJCR/L0808K07-SM	●	★	DCMT DCMW DCET DCGT DCGW	0702 $\odot\odot$	8	8	125	15	2	8	0	TS254	TKY08R
SDJCR/L1010K07-SM	●	★		0702 $\odot\odot$	10	10	125	—	—	10	0	TS254	TKY08R
SDJCR/L1010K11-SM	●	★		11T3 $\odot\odot$	10	10	125	24	4	10	0	TS43	TKY15R
SDJCR/L1212M11-SM	●	★		11T3 $\odot\odot$	12	12	150	22	2	12	0	TS43	TKY15R
SDJCR/L1616M11-SM	●	★		11T3 $\odot\odot$	16	16	150	—	—	16	0	TS43	TKY15R

* Clamp Torque (N · m) : TS254=1.0, TS43=3.5

Order Number		Stock		Insert Number		Dimensions (mm)					*		
						H	B	LF	LH	HBKW	HF	WF2	Clamp Screw
SDNCR/L0808K07-SM	●	★	DCMT DCMW DCET DCGT DCGW	0702 $\odot\odot$	8	8	125	—	—	8	3	TS254	TKY08R
SDNCR/L1010K07-SM	●	★		0702 $\odot\odot$	10	10	125	—	—	10	3	TS254	TKY08R
SDNCR/L1010K11-SM	●	★		11T3 $\odot\odot$	10	10	125	24	2	10	5	TS43	TKY15R
SDNCR/L1212M11-SM	●	★		11T3 $\odot\odot$	12	12	150	—	—	12	5	TS43	TKY15R
SDNCR/L1616M11-SM	●	★		11T3 $\odot\odot$	16	16	150	—	—	16	5	TS43	TKY15R

* Clamp Torque (N · m) : TS254=1.0, TS43=3.5

RECOMMENDED CUTTING CONDITIONS

	Work Material	Hardness	Grade	Cutting Speed (m/min)	Feed (mm/rev)
P	Carbon Steel · Alloy Steel	180HB–280HB	MS6015/VP15TF	100 (50–150)	0.08 (0.01–0.15)
	Free Cutting Steel	—	MS6015	110 (30–180)	0.08 (0.01–0.15)
			NX2525	150 (50–250)	0.08 (0.01–0.15)
M	Stainless Steel	≤200HB	VP15TF/MP9005/MP9015	80 (50–120)	0.06 (0.02–0.1)
		230HB	MS9025	100 (50–180)	0.08 (0.01–0.15)
N	Non-Ferrous Metal	—	HTi10/MT9005	150 (70–230)	0.09 (0.03–0.15)
S	Titanium Alloy	—	MT9005	60 (40–80)	0.08 (0.04–0.12)
	Heat Resistant Alloy	—	MP9015/MS9025	50 (20–75)	0.08 (0.04–0.12)

SDJC-SM type inserts > **A147–A152**
SDNC-SM type inserts > **A147–A152**
CBN & PCD inserts > **B054, B055, B068**

SPARE PARTS > **N001**
TECHNICAL DATA > **P001**

EXTERNAL FRONT TURNING

SVLP-SM

Without offset

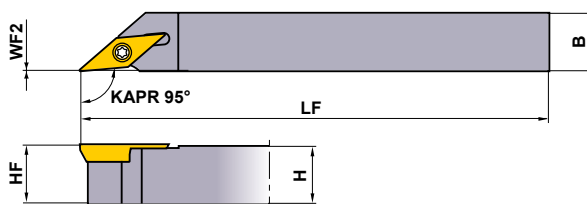
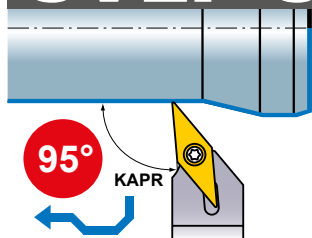

Right hand tool holder shown.

Finish
R/L-SRF



(08,11)

Finish
SMG



(08,11)

Order Number	Stock		Insert Number	Dimensions (mm)					* Clamp Screw	Wrench	
	R	L		H	B	LF	HF	WF2			
SVLPR/L1010K08-SM	●	★	VPET VPGT	0802	10	10	125	10	0	TS202	TKY06R
SVLPR/L1212M08-SM	●	★		0802	12	12	150	12	0	TS202	TKY06R
SVLPR/L1010K11-SM	●	★		1103	10	10	125	10	0	TS255	TKY08R
SVLPR/L1212M11-SM	●	★		1103	12	12	150	12	0	TS255	TKY08R
SVLPR/L1616M11-SM	●	★		1103	16	16	150	16	0	TS255	TKY08R

* Clamp Torque (N · m) : TS202=0.6, TS255=1.0

SVJB-SM

Without offset

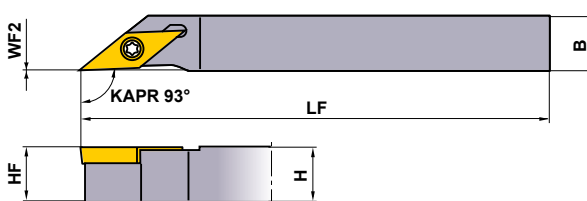
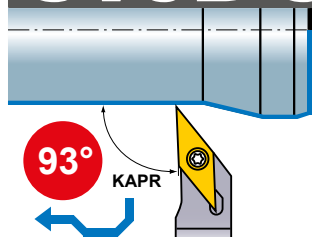

Right hand tool holder shown.

Finish
R/L-F



(11)

Medium
R/L-SN

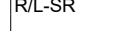

(11)

Order Number	Stock		Insert Number	Dimensions (mm)					* Clamp Screw	Wrench	
	R	L		H	B	LF	HF	WF2			
SVJBR/L1010K11-SM	●	★	VBMT VBET VBGT VBGW	1103	10	10	125	10	0	TS255	TKY08R
SVJBR/L1212M11-SM	●	★		1103	12	12	150	12	0	TS255	TKY08R
SVJBR/L1616M11-SM	●	★		1103	16	16	150	16	0	TS255	TKY08R

* Clamp Torque (N · m) : TS255=1.0

RECOMMENDED CUTTING CONDITIONS

Work Material	Hardness	Grade	Cutting Speed (m/min)	Feed (mm/rev)
P Carbon Steel · Alloy Steel	180HB–280HB	MS6015/VP15TF	100 (50–150)	0.08 (0.01–0.15)
		MS6015	110 (30–180)	0.08 (0.01–0.15)
	Free Cutting Steel	–	NX2525	150 (50–250)
M Stainless Steel	≤200HB	VP15TF/MP9005/MP9015	80 (50–120)	0.06 (0.02–0.1)
	230HB	MS9025	100 (50–180)	0.08 (0.01–0.15)
N Non-Ferrous Metal	–	HTi10/MT9005	150 (70–230)	0.09 (0.03–0.15)
S Titanium Alloy	–	MT9005	60 (40–80)	0.08 (0.04–0.12)
	–	MP9015/MS9025	50 (20–75)	0.08 (0.04–0.12)

Note 1) The insert photos are only examples. The letters refer to the chipbreaker and the dimension refers to the inscribed circle.

Note 2) Dimensions shown for insert corner RE 0.2.

● : Inventory maintained. ★ : Inventory maintained in Japan.

SVLP-SM type inserts > A171
SVJB-SM type inserts > A164–A166
CBN & PCD inserts > B059, B071

SVJC-SM		Without offset								Finish	Finish	Light	Light
										FP	FM	LS	LS-P
										 (11)	 (11)	 (11,13)	 (11,13)
		Right hand tool holder shown.								Light	Light	Light	
										LP	LM	LS	
										(11)	(11)	(11)	
Order Number	Stock		Insert Number		Dimensions (mm)						*		
	R	L			H	B	LF	HBKW	HF	WF2	Clamp Screw	Wrench	
SVJCR/L1010JX11-SM	●	●	VCMW VCMT VCGT	1103	10	10	120	—	10	0	TS255	TKY08R	
SVJCR/L1212JX11-SM	●	●		1103	12	12	120	—	12	0	TS255	TKY08R	
SVJCR/L1616JX11-SM	●	●		1103	16	16	120	—	16	0	TS255	TKY08R	
SVJCR/L1010JX13-SM	●	●		1303	10	10	120	2	10	0	TS32	TKY08R	
SVJCR/L1212JX13-SM	●	●		1303	12	12	120	—	12	0	TS32	TKY08R	
SVJCR/L1616JX13-SM	●	●		1303	16	16	120	—	16	0	TS32	TKY08R	

* Clamp Torque (N · m) : TS255=1.0, TS32=1.0

SVPP-SM										Finish			
										R/L-SRF			
										 (11)			
		Right hand tool holder shown.								Finish SMG			
										 (11)			
										 SVPPR/L1616M11-SM			
Order Number	Stock		Insert Number		Dimensions (mm)						*		
	R	L			H	B	LF	LH	HBKW	HF	WF2	Clamp Screw	Wrench
SVPPR/L1010K11-SM	●	★	VPET VPGT	1103	10	10	125	20	8	10	0	TS255	TKY08R
SVPPR/L1212M11-SM	●	★		1103	12	12	150	20	6	12	0	TS255	TKY08R
SVPPR/L1616M11-SM	●	★		1103	16	16	150	17	—	16	0	TS255	TKY08R

* Clamp Torque (N · m) : TS255=1.0

SVVB-SM		Neutral edge with handed holder								Finish	Medium	
										R/L-F	R/L-SN	
										 (11)	 (11)	
		Right hand tool holder shown.								Medium R/L-SR		
										 (11)		
Order Number	Stock		Insert Number		Dimensions (mm)						*	
	R	L			H	B	LF	HF	WF2	Clamp Screw	Wrench	
SVVBR/L1010K11-SM	●	★	VBET VBGT VBMT VBGW	1103	10	10	125	10	3	TS255	TKY08R	
SVVBR/L1212M11-SM	●	★		1103	12	12	150	12	3	TS255	TKY08R	
SVVBR/L1616M11-SM	●	★		1103	16	16	150	16	3	TS255	TKY08R	

* Clamp Torque (N · m) : TS255=1.0

SVJC-SM type inserts > A167–A169
 SVPP-SM type inserts > A171
 SVVB-SM type inserts > A164–A166

CBN & PCD inserts > B059, B060, B071
 SPARE PARTS > N001
 TECHNICAL DATA > P001

EXTERNAL BACK TURNING

BTAH

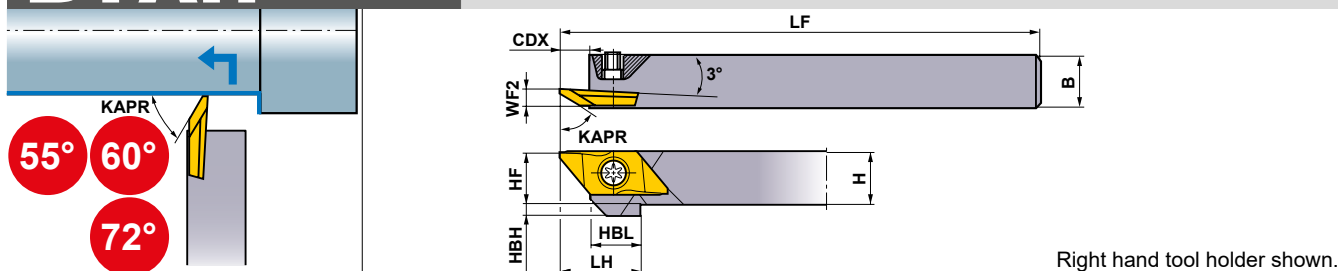

Order Number	Stock		Insert Number	Dimensions (mm)										Clamp Screw *	Wrench
	R	L		H	B	LF	LH	HF	WF2	HBH	HBL	CDX			
BTahr/L0810-50	●	★	BTAT	5528	10	120	15	8	3.5	4	9.5	5.5	NS402W	NKY15S	
BTahr/L1010-50	●	★		6035	10	120	15	10	3.5	2	9.5	5.5	NS402W	NKY15S	
BTahr/L1212-50	●	★		605000RX	12	120	15	12	3.5	—	9.5	5.5	NS403W	NKY15S	
BTahr/L1616-50	●	★		7235	16	120	15	16	3.5	—	9.5	5.5	NS403W	NKY15S	

Note 1) Please use right hand inserts for right hand holders and left hand inserts for left hand holders.

Note 2) Set the maximum depth of cut at under 60% of the effective cutting edge length (LE).

* Clamp Torque (N · m) : NS402W=1.0, NS403W=1.0

INSERTS

Order Number	Hand	Coated		Dimensions (mm)							LE* (mm)	Geometry
		VP15TF	NEW MS6015	PSIRR/L*	RER/L	CF	L	W1	CW	S		
NEW BTAT7235V5R-SMB	R	●		72°	0.05	0.3	20	8	1.4	2.5	3.5	With Breaker
NEW BTAT723501MR-SMB	R	●		72°	0.08	0.3	20	8	1.4	2.5	3.5	
NEW BTAT723502MR-SMB	R	●		72°	0.18	0.3	20	8	1.4	2.5	3.5	
BTAT552800R-B	R	●	●	55°	0	0	20	8	0.5	2.5	2.8	SMB Type (Moulded) B Type (Grinding)
BTAT552800L-B	L	★		55°	0	0	20	8	0.5	2.5	2.8	
BTAT552801R-B	R	●	●	55°	0.1	0	20	8	0.5	2.5	2.8	
BTAT552801L-B	L	★		55°	0.1	0	20	8	0.5	2.5	2.8	
BTAT603500R-B	R	●	●	60°	0	0	20	8	0.5	2.5	3.5	Without Breaker
BTAT603500L-B	L	★		60°	0	0	20	8	0.5	2.5	3.5	
NEW BTAT603501MR-B	R	●	●	60°	0.08	0	20	8	0.5	2.5	3.5	
BTAT603501R-B	R	●	●	60°	0.1	0	20	8	0.5	2.5	3.5	
BTAT603501L-B	L	★		60°	0.1	0	20	8	0.5	2.5	3.5	
BTAT605000RX	R	●		60°	0	0	20	8	1.25	2.5	5.0	

Note 1) REL, PSIRR dimensions for Right Hand Tool and RER. PSIRL dimensions for Left Hand Tool.

* Numeric value set insert on holder.

● = NEW

RECOMMENDED CUTTING CONDITIONS

Work Material	Hardness	Grade	Cutting Speed (m/min)	Feed (mm/rev)
P Carbon Steel · Alloy Steel	180HB–280HB	MS6015/VP15TF	100 (50–150)	0.08 (0.01–0.15)
	Free Cutting Steel	—	MS6015	110 (30–180)
M Stainless Steel	≤200HB	VP15TF	80 (50–120)	0.06 (0.02–0.1)
N Non-Ferrous Metal	—	MS6015	150 (70–230)	0.09 (0.03–0.15)



● : Inventory maintained. ★ : Inventory maintained in Japan.

(5 inserts in one case)

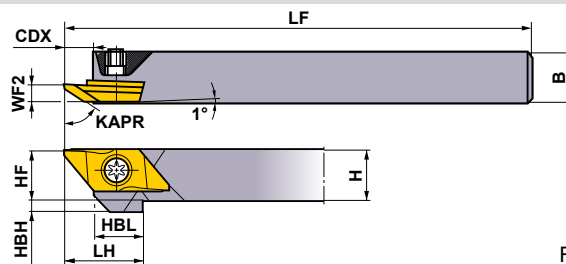
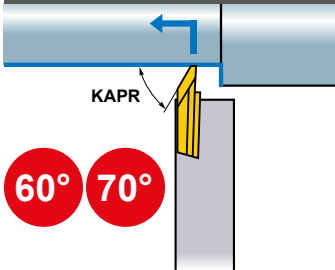
CTBH



Right hand tool holder shown.

Order Number	Stock		Insert Number	Dimensions (mm)								*  					
	R	L		H	B	LF	LH	HF	WF2	HBH	HBL	CDX	Clamp Screw	Wrench			
CTBHR/L1010-160	●	●	BTBT	60450	○	R/L-B	10	10	120	19.5	10	3.4	2	12	7.5	NS402W	NKY15S
CTBHR/L1212-160	●	●		606000	R/L	12	12	120	19.5	12	3.4	—	12	7.5	NS403W	NKY15S	
CTBHR/L1616-160	●	●		7055	○	R-SMB	16	16	120	19.5	16	3.4	—	12	7.5	NS403W	NKY15S

Note 1) Please use right hand inserts for right hand holders and left hand inserts for left hand holders.

Note 2) Set the maximum depth of cut at under 60% of the effective cutting edge length (LE).

* Clamp Torque (N · m) : NS402W=1.0, NS403W=1.0

D

SMALL TOOLS

INSERTS

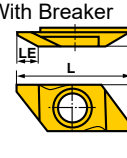
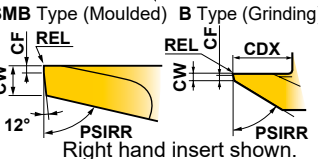
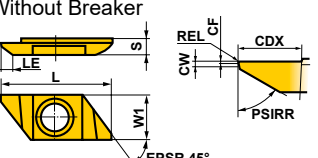
Order Number	Hand	Coated		Dimensions (mm)								LE* (mm)	Geometry
		VP15TF	NEW MS6015	PSIRRL*	RER/L	CF	L	W1	CW	S	CDX		
NEW BTBT7055V5R-SMB	R	●		70°	0.05	0.3	25	9.4	1.35	3.5	6.5	5.5	
NEW BTBT705501MR-SMB	R	●		70°	0.08	0.3	25	9.4	1.35	3.5	6.5	5.5	
NEW BTBT705502MR-SMB	R	●		70°	0.18	0.3	25	9.4	1.35	3.5	6.5	5.5	
BTBT604500R-B	R	●	●	60°	0	0.2	25	9.4	0.7	3.5	5.5	4.5	 <p>SMB Type (Moulded) B Type (Grinding)</p>
BTBT604500L-B	L	★		60°	0	0.2	25	9.4	0.7	3.5	5.5	4.5	
NEW BTBT604501MR-B	R		●	60°	0.08	0.3	25	9.4	0.7	3.5	5.5	4.5	
BTBT604501R-B	R	●	●	60°	0.1	0.3	25	9.4	0.7	3.5	5.5	4.5	
BTBT604501L-B	L	★		60°	0.1	0.3	25	9.4	0.7	3.5	5.5	4.5	
BTBT606000R	R	●		60°	0	0.2	25	9.4	0.7	3.5	7	6.0	
BTBT606000L	L	★		60°	0	0.2	25	9.4	0.7	3.5	7	6.0	 <p>Without Breaker</p> <p>Right hand insert shown.</p>

Note 1) REL, PSIRR dimensions for Right Hand Tool and RER. PSIRL dimensions for Left Hand Tool.

* Numeric value set insert on holder.

● = NEW

EXTERNAL BACK TURNING

BTVH

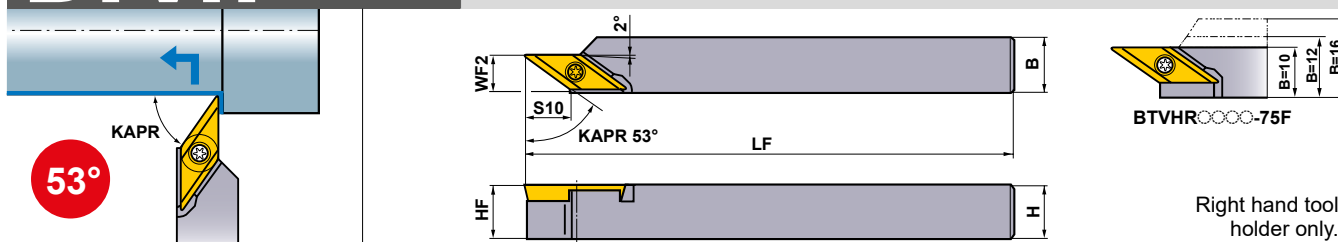

Right hand tool holder only.

Order Number	Stock	Insert Number	Dimensions (mm)						*	
	R		H	B	LF	HF	WF2	S10	Clamp Screw	Wrench
BTVHR1010-75	●	BTVT 5375○○R-B	10	10	120	10	7.5	8.5	NS251	NKY15S
BTVHR1212-75	●		12	12	120	12	7.5	8.5	NS251	NKY15S
BTVHR1616-75	●		16	16	120	16	7.5	8.5	NS251	NKY15S
BTVHR1010-75F	●		10	10	120	10	10.0	8.5	NS251	NKY15S
BTVHR1212-75F	●		12	12	120	12	10.0	8.5	NS251	NKY15S
BTVHR1616-75F	●		16	16	120	16	10.0	8.5	NS251	NKY15S

Note 1) Set the maximum depth of cut at under 30% of the effective cutting edge length (LE).

Note 2) For high load machining, F type is recommended.

* Clamp Torque (N · m) : NS251=1.0

INSERTS

Order Number	Hand	Coated	Dimensions (mm)				LE* (mm)	Geometry
		VP15TF	IC	S	REL	CW		
BTVT5375V5R-B	R	●	6.35	3.18	0.05	0.5	7.5	With Breaker
BTVT537501R-B	R	●	6.35	3.18	0.1	0.5	7.5	

* Numeric value set insert on holder.

RECOMMENDED CUTTING CONDITIONS

	Work Material	Hardness	Grade	Cutting Speed (m/min)	Feed (mm/rev)
P	Carbon Steel · Alloy Steel	180HB—280HB	VP15TF	100 (50—150)	0.08 (0.01—0.15)
	Free Cutting Steel	—	VP15TF	110 (30—180)	0.08 (0.01—0.15)
M	Stainless Steel	≤200HB	VP15TF	80 (50—120)	0.06 (0.02—0.1)
N	Non-Ferrous Metal	—	VP15TF	150 (70—230)	0.09 (0.03—0.15)

● : Inventory maintained.
(5 inserts in one case)

SPARE PARTS > N001
TECHNICAL DATA > P001

Memo

A series of horizontal dashed lines for writing, spanning the width of the page.

EXTERNAL GROOVING

GTAH, GTBH, GTCH

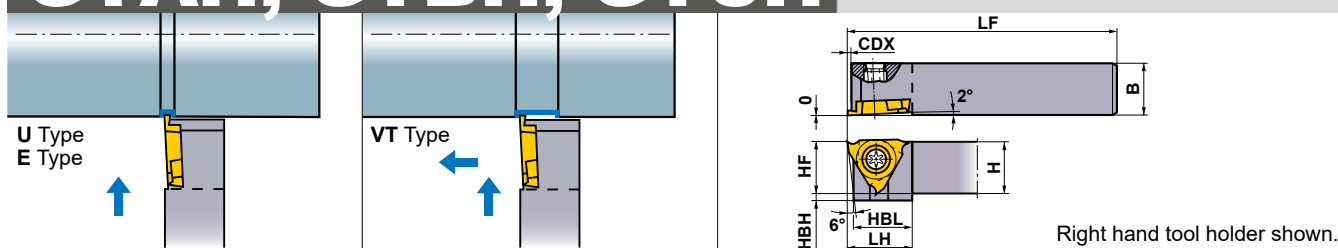

Order Number	Stock		Insert Number	Dimensions (mm)									Cutting Width (mm)	*2		
	R	L		H	B	HF	LF	CDX*1	LH	HBH	HBL	Clamp Screw		Wrench		
Standard Shank	GTAHR/L0808-20S	●	★	GTAT	○○○○	8	8	8	80	2	15	5	12.9	0.3-3.0	NS404W	NKY15S
	GTAHR/L1010-20S	●	★	GTBT *1	○○○○	10	10	10	80	2	15	3	12.9	0.3-3.0	NS404W	NKY15S
	GTAHR/L1212-20S	●	★	GTCT *1	○○○○	12	12	12	80	2	15	1	12.9	0.3-3.0	NS404W	NKY15S
	GTBHR/L1010-30S	●	★	GTBT. GTCT	○○○○	10	10	10	80	3	15	3	13.4	1.45-3.0	NS404W	NKY15S
	GTCHR/L1010-30S	★	★	GTCT	○○○○	10	10	10	80	3	15	3	13.4	2.5-3.0	NS404W	NKY15S
Long Shank	GTAHR/L0808-20	●	★	GTAT	○○○○	8	8	8	120	2	15	5	12.9	0.3-3.0	NS404W	NKY15S
	GTAHR/L1010-20	●	★	GTBT *1	○○○○	10	10	10	120	2	15	3	12.9	0.3-3.0	NS404W	NKY15S
	GTAHR/L1212-20	●	★	GTCT *1	○○○○	12	12	12	120	2	15	1	12.9	0.3-3.0	NS404W	NKY15S
	GTAHR/L1616-20	●	★		○○○○	16	16	16	120	2	15	-	12.9	0.3-3.0	NS404W	NKY15S
	GTBHR/L1010-30	●	★	GTBT. GTCT	○○○○	10	10	10	120	3	15	3	13.4	1.45-3.0	NS404W	NKY15S
	GTBHR/L1212-30	●	★	GTBT. GTCT	○○○○	12	12	12	120	3	15	1	13.4	1.45-3.0	NS404W	NKY15S
	GTBHR/L1616-30	●	★		○○○○	16	16	16	120	3	15	-	13.4	1.45-3.0	NS404W	NKY15S
	GTCHR/L1010-30	★	★	GTCT	○○○○	10	10	10	120	3	15	3	13.4	2.5-3.0	NS404W	NKY15S

Note 1) Please use right hand inserts for right hand holders and left hand inserts for left hand holders.

*1 It is not possible to machine depths over CDX dimensions (Max. Groove Depth).

*2 Clamp Torque (N · m) : NS404W=1.0

INSERTS

Order Number	Hand	Coated	Dimensions (mm)					Geometry
		VP15TF	CW	CDX*1	RER/L	IC	S	
GTAT03006V3R-U	R	●	0.3	0.6	0.03	9.525	3.18	U Type Breaker (General purpose Grooving)
GTAT03006V3L-U	L	★	0.3	0.6	0.03	9.525	3.18	
GTAT05012V5R-U	R	●	0.5	1.2	0.05	9.525	3.18	
GTAT05012V5L-U	L	★	0.5	1.2	0.05	9.525	3.18	
GTAT07520V5R-U	R	●	0.75	2.0	0.05	9.525	3.18	
GTAT07520V5L-U	L	★	0.75	2.0	0.05	9.525	3.18	
GTAT09520V5R-U	R	●	0.95	2.0	0.05	9.525	3.18	
GTAT09520V5L-U	L	★	0.95	2.0	0.05	9.525	3.18	
GTAT10020V5R-U	R	●	1.0	2.0	0.05	9.525	3.18	
GTAT10020V5L-U	L	★	1.0	2.0	0.05	9.525	3.18	
GTAT10320V5R-U	R	●	1.03	2.0	0.05	9.525	3.18	
GTAT12520V5R-U	R	●	1.25	2.0	0.05	9.525	3.18	
GTAT12520V5L-U	L	★	1.25	2.0	0.05	9.525	3.18	
GTBT14530V5R-U	R	●	1.45	3.0	0.05	9.525	3.18	
GTBT14530V5L-U	L	★	1.45	3.0	0.05	9.525	3.18	
GTBT15030V5R-U	R	●	1.5	3.0	0.05	9.525	3.18	
GTBT15030V5L-U	L	★	1.5	3.0	0.05	9.525	3.18	
GTBT17530V5R-U	R	●	1.75	3.0	0.05	9.525	3.18	
GTBT17530V5L-U	L	★	1.75	3.0	0.05	9.525	3.18	
GTBT20030V5R-U	R	●	2.0	3.0	0.05	9.525	3.18	
GTBT20030V5L-U	L	★	2.0	3.0	0.05	9.525	3.18	
GTCT25030V5R-U	R	★	2.5	3.0	0.05	9.525	3.18	
GTCT25030V5L-U	L	★	2.5	3.0	0.05	9.525	3.18	

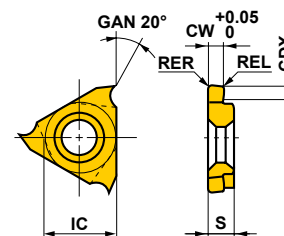

Right hand insert shown.

*1 It is not possible to machine depths over CDX dimensions (Max. Groove Depth).

● : Inventory maintained. ★ : Inventory maintained in Japan.
(5 inserts in one case)

INSERTS

Order Number	Hand	Coated	Carbide	Dimensions (mm)					Geometry
		VP15TF	TF15	CW	CDX	RER/L	IC	S	
GTAT03306V3R-E	R	●		0.33	0.6	0.03	9.525	3.18	E Type Breaker (Ring processing Grooving)
GTAT03306V3L-E	L	★		0.33	0.6	0.03	9.525	3.18	
GTAT04312V3R-E	R	●		0.43	1.2	0.03	9.525	3.18	
GTAT04312V3L-E	L	★		0.43	1.2	0.03	9.525	3.18	
GTAT05312V5R-E	R	●		0.53	1.2	0.05	9.525	3.18	
GTAT05312V5L-E	L	★		0.53	1.2	0.05	9.525	3.18	
GTAT07520V5R-E	R	●		0.75	2.0	0.05	9.525	3.18	
GTAT07520V5L-E	L	★		0.75	2.0	0.05	9.525	3.18	
GTAT09520V5R-E	R	●		0.95	2.0	0.05	9.525	3.18	
GTAT09520V5L-E	L	★		0.95	2.0	0.05	9.525	3.18	
GTAT10020V5R-E	R	●		1.0	2.0	0.05	9.525	3.18	
GTAT10020V5L-E	L	★		1.0	2.0	0.05	9.525	3.18	
GTAT1002001R-E	R	●		1.0	2.0	0.1	9.525	3.18	
GTAT1002001L-E	L	★		1.0	2.0	0.1	9.525	3.18	
GTAT12020V5R-E	R	●		1.2	2.0	0.05	9.525	3.18	
GTAT12020V5L-E	L	★		1.2	2.0	0.05	9.525	3.18	
GTAT1202001R-E	R	●		1.2	2.0	0.1	9.525	3.18	
GTAT1202001L-E	L	★		1.2	2.0	0.1	9.525	3.18	
GTAT14020V5R-E	R	●		1.4	2.0	0.05	9.525	3.18	
GTAT14020V5L-E	L	★		1.4	2.0	0.05	9.525	3.18	
GTBT15030V5R-E	R	●		1.5	3.0	0.05	9.525	3.18	
GTBT15030V5L-E	L	★		1.5	3.0	0.05	9.525	3.18	
GTBT1503001R-E	R	●		1.5	3.0	0.1	9.525	3.18	
GTBT1503001L-E	L	★		1.5	3.0	0.1	9.525	3.18	
GTBT18030V5R-E	R	●		1.8	3.0	0.05	9.525	3.18	
GTBT18030V5L-E	L	★		1.8	3.0	0.05	9.525	3.18	
GTBT20030V5R-E	R	●		2.0	3.0	0.05	9.525	3.18	
GTBT20030V5L-E	L	★		2.0	3.0	0.05	9.525	3.18	
GTBT2003001R-E	R	●		2.0	3.0	0.1	9.525	3.18	
GTBT2003001L-E	L	★		2.0	3.0	0.1	9.525	3.18	
GTBT22530V5R-E	R	●		2.25	3.0	0.05	9.525	3.18	
GTBT22530V5L-E	L	★		2.25	3.0	0.05	9.525	3.18	
GTCT25030V5R-E	R	★		2.5	3.0	0.05	9.525	3.18	
GTCT25030V5L-E	L	★		2.5	3.0	0.05	9.525	3.18	
GTCT27530V5R-E	R	★		2.75	3.0	0.05	9.525	3.18	
GTCT27530V5L-E	L	★		2.75	3.0	0.05	9.525	3.18	
GTCT30030V5R-E	R	★		3.0	3.0	0.05	9.525	3.18	
GTCT30030V5L-E	L	★		3.0	3.0	0.05	9.525	3.18	
GTATR	R		★★	1.76	3.0	—	9.525	3.18	Blank
GTATL	L		★★	1.76	3.0	—	9.525	3.18	
GTBTR	R		★★	—	0	—	9.525	3.18	
GTBTL	L		★★	—	0	—	9.525	3.18	

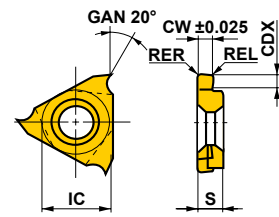

Right hand insert shown.

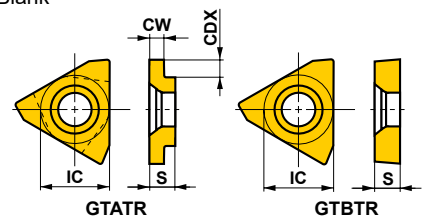

Right hand insert shown.

* 10 inserts in one case.

CUTTING CONDITIONS > D020
 SPARE PARTS > N001
 TECHNICAL DATA > P001

EXTERNAL CUTTING OFF

CTAH

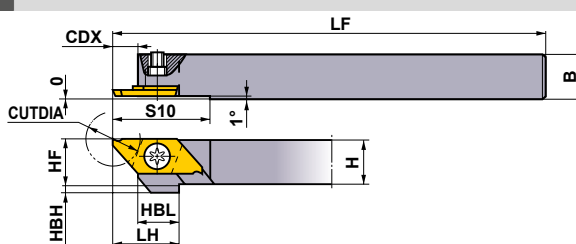
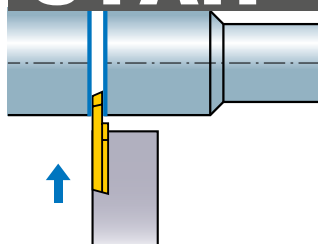

Right hand tool holder shown.

Order Number	Stock		Insert Number	Dimensions (mm)									CUTDIA (mm)	*2		
	R	L		H	B	HF	LF	LH	CDX	HBH	HBL	S10		Clamp Screw	Wrench	
CTAHR/L0810-120	●	●	CTAT	○	8	10	8	120	15	5.5	4	9.5	22	12 (8)*1	NS402W	NKY15S
CTAHR/L1010-120	●	●		○	10	10	10	120	15	5.5	2	9.5	22		NS402W	NKY15S
CTAHR/L1212-120	●	●		○	12	12	12	120	15	5.5	—	9.5	22		NS403W	NKY15S
CTAHR/L1616-120	●	●		○	16	16	16	120	15	5.5	—	9.5	22		NS403W	NKY15S

*1 When the width of cutting off (CW) is 0.7mm.

*2 Clamp Torque (N • m) : NS402W=1.0, NS403W=1.0

SMALL TOOLS

CTAH-S

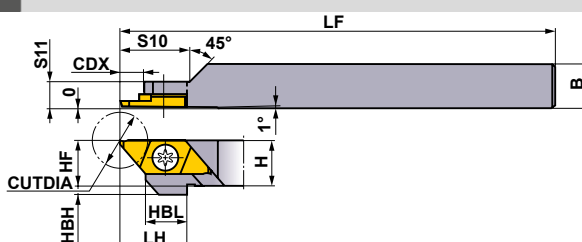
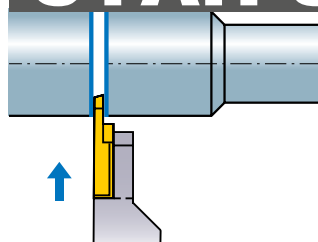

Right hand tool holder only.

Order Number	Stock		Insert Number	Dimensions (mm)										CUTDIA (mm)	*2		
	R	L		H	B	HF	LF	LH	CDX	HBH	HBL	S10	S11		Clamp Screw	Wrench	
CTAHR1010-120S	●		CTAT	○	10	10	10	80	15	16	2	9.5	16	5.5	12 (8)*1	NS401	NKY25R

*1 When the width of cutting off (CW) is 0.7mm.

*2 Clamp Torque (N • m) : NS401=3.5

RECOMMENDED CUTTING CONDITIONS

	Work Material	Hardness	Grade	Cutting Speed (m/min)	Feed (mm/rev)
P	Carbon Steel · Alloy Steel	180HB—280HB	MS6015/VP15TF	100 (50—150)	0.05 (0.02—0.09)
	Free Cutting Steel	—	MS6015	110 (30—180)	0.05 (0.01—0.09)
M	Stainless Steel	≤200HB	VP15TF	80 (50—120)	0.03 (0.02—0.05)
N	Non-Ferrous Metal	—	MS6015	150 (70—230)	0.07 (0.03—0.11)

● : Inventory maintained.
(5 inserts in one case)

INSERTS

Holder	Setting Geometry	Breaker	Geometry	Insert Geometry	Order Number	Hand	Coated		Dimensions (mm)								CUTDIA (mm)	
							VP15TF	MS6015	CW	CDX	RER/L	L	W1	S	LBB			
Right Hand (R)	16°		<p>EPSCR 50°</p>	REL	CDX	LBB	R	●		0.7	4.5	0.05	20	8	2.5	1.5	8	
				CW ±0.05			R	●	●	1.0	6.7	0.05	20	8	2.5	1.5	12	
				RER			R	●	●	1.5	6.7	0.05	20	8	2.5	1.5	12	
							R	●	●	2.0	6.7	0.05	20	8	2.5	1.5	12	
	16°				REL	CDX	LBB	R	●		1.5	6.7	0.05	20	8	2.5	1.5	12
					CW ±0.05			R	●		2.0	6.7	0.05	20	8	2.5	1.5	12
					RER		Strong Edge Type											
	0°	With Breaker			REL	CDX	LBB	N	●	●	1.0	6.7	0.05	20	8	2.5	1.5	12
					CW ±0.05			N	●	●	1.5	6.7	0.05	20	8	2.5	1.5	12
					RER			N	●	●	2.0	6.7	0.05	20	8	2.5	1.5	12
0°			REL	CDX	LBB	N	●		1.5	6.7	0.05	20	8	2.5	1.5	12		
			CW ±0.05			N	●		2.0	6.7	0.05	20	8	2.5	1.5	12		
			RER		Strong Edge Type													
16°			REL	CDX	LBB	L	●		1.0	6.7	0.05	20	8	2.5	1.5	11		
			CW ±0.05			L	●		1.5	6.7	0.05	20	8	2.5	1.5	11		
			RER			L	●		2.0	6.7	0.05	20	8	2.5	1.5	11		
20°	Without Breaker		REL	CDX	LBB	R	●	●	1.0	6.7	0	20	8	2.5	3.5	12		
			CW ±0.05			R	●	●	1.5	6.7	0	20	8	2.5	3.5	12		
			RER			R	●	●	2.0	6.7	0	20	8	2.5	3.5	12		
Left Hand (L)	16°		REL	CDX	LBB	L	●		0.7	4.5	0.05	20	8	2.5	1.5	8		
			CW ±0.05			L	●		1.0	6.7	0	20	8	2.5	1.5	12		
			RER			L	●		1.5	6.7	0	20	8	2.5	1.5	12		
						L	●		2.0	6.7	0	20	8	2.5	1.5	12		
	0°	With Breaker		REL	CDX	LBB	N	●	●	1.0	6.7	0.05	20	8	2.5	1.5	12	
				CW ±0.05			N	●	●	1.5	6.7	0.05	20	8	2.5	1.5	12	
				RER			N	●	●	2.0	6.7	0.05	20	8	2.5	1.5	12	
16°			REL	LBB	CDX	R	●	●	1.0	6.7	0.05	20	8	2.5	1.5	11		
			CW ±0.05			R	●	●	1.5	6.7	0.05	20	8	2.5	1.5	11		
			RER			R	●	●	2.0	6.7	0.05	20	8	2.5	1.5	11		
20°	Without Breaker		REL	LBB	CDX	L	●		1.0	6.7	0	20	8	2.5	3.5	12		
			CW ±0.05			L	●		1.5	6.7	0	20	8	2.5	3.5	12		
			RER			L	●		2.0	6.7	0	20	8	2.5	3.5	12		

Right hand insert shown.

D
SMALL TOOLS

EXTERNAL CUTTING OFF

CTBH

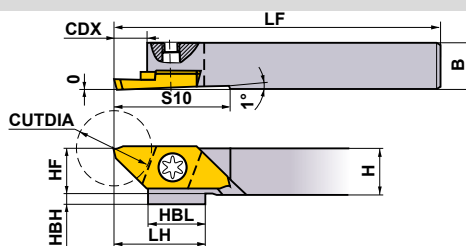
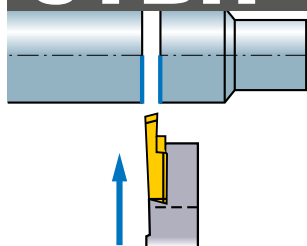

Right hand tool holder shown.

Order Number	Stock		Insert Number	Dimensions (mm)									CUTDIA (mm)	*	
	R	L		H	B	HF	LF	LH	CDX	HBH	HBL	S10		Clamp Screw	Wrench
CTBHR/L1010-160	●	●	CTBT	10	10	10	120	19.5	7.5	2	9.5	25	16	NS402W	NKY15S
CTBHR/L1212-160	●	●		12	12	12	120	19.5	7.5	—	9.5	25	16	NS403W	NKY15S
CTBHR/L1616-160	●	●		16	16	16	120	19.5	7.5	—	9.5	25	16	NS403W	NKY15S

* Clamp Torque (N · m) : NS402W=1.0, NS403W=1.0

D

SMALL TOOLS

INSERTS

Holder	Setting Geometry	Breaker	Geometry	Insert Geometry	Order Number	Hand	Coated		Dimensions (mm)							CUTDIA (mm)
							VP15TF	MS6015	CW	CDX	RER/L	L	W1	S		
Right Hand (R)		With Breaker			CTBT15160V5RR-B	R	●	●	1.5	9.2	0.05	25	9.4	3.5	16	
					CTBT20160V5RR-B	R	●	●	2.0	9.2	0.05	25	9.4	3.5	16	
				CTBT20160V5RN-B	N	●	●	2.0	9.2	0.05	25	9.4	3.5	16		
Left Hand (L)		With Breaker			CTBT20160V5LL-B	L	●		2.0	9.2	0.05	25	9.4	3.5	16	
					CTBT20160V5LN-B	N	●	●	2.0	9.2	0.05	25	9.4	3.5	16	
				CTBT20145V5LR-B	R	●	●	2.0	9.2	0.05	25	9.4	3.5	14.5		

RECOMMENDED CUTTING CONDITIONS

	Work Material	Hardness	Grade	Cutting Speed (m/min)	Feed (mm/rev)
P	Carbon Steel · Alloy Steel	180HB—280HB	MS6015/VP15TF	100 (50—150)	0.05 (0.02—0.09)
	Free Cutting Steel	—	MS6015	110 (30—180)	0.05 (0.01—0.09)
M	Stainless Steel	≤200HB	VP15TF	80 (50—120)	0.03 (0.02—0.05)
N	Non-Ferrous Metal	—	MS6015	150 (70—230)	0.07 (0.03—0.11)

● : Inventory maintained.
(5 inserts in one case)

SPARE PARTS > N001
TECHNICAL DATA > P001

Memo





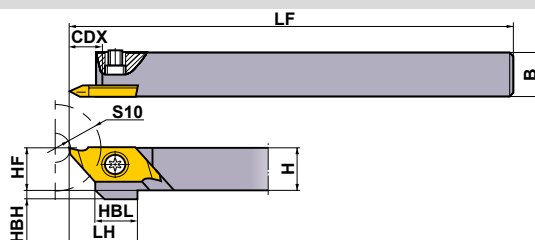
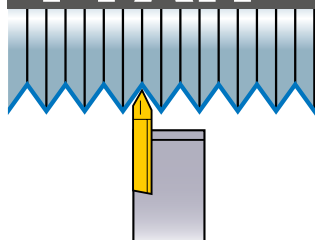

A series of horizontal dashed lines for writing, spanning the width of the page.

EXTERNAL THREADING

TTAH







Right hand tool holder shown.

Order Number	Stock		Insert Number	Dimensions (mm)									*  		
	R	L		H	B	HF	LF	LH	HBH	HBL	CDX	S10	Clamp Screw	Wrench	
TTAHR/L0810	●	★	TTAT		8	10	8	120	15	4	9.5	7	6.5	NS402W	NKY15S
TTAHR/L1010	●	★			10	10	10	120	15	2	9.5	7	6.5	NS402W	NKY15S
TTAHR/L1212	●	★			12	12	12	120	15	—	9.5	7	6.5	NS403W	NKY15S
TTAHR/L1616	●	★			16	16	16	120	15	—	9.5	7	6.5	NS403W	NKY15S

* Clamp Torque (N · m) : NS402W=1.0, NS403W=1.0

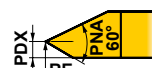
SMALL TOOLS

INSERTS

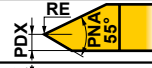
Holder	Setting Geometry	Breaker	Geometry	Insert Geometry	Order Number	Hand	Coated	Dimensions (mm)					Pitch of Screw mm (thread/inch)					
							VP15TF	PDX	RE	L	W1	S						
Right Hand (R)			General Purpose Partial Profile (60°)		TTAT60075F5RR-B	R	●	0.4	0.05 Flat	20.0	8.0	2.5	0.2-0.75 (80-36)					
					TTAT60125V5RR-B	R	●	0.8	0.05	20.0	8.0	2.5	0.5-1.25 (40-16)					
					TTAT60075F5RL-B	L	●	0.4	0.05 Flat	20.0	8.0	2.5	0.2-0.75 (80-36)					
					TTAT60125V5RL-B	L	●	0.8	0.05	20.0	8.0	2.5	0.5-1.25 (40-16)					
Left Hand (L)		With Breaker	General Purpose Partial Profile (60°)		TTAT6015001RN-B	N	●	1.25	0.1	20.0	8.0	2.5	1.0-1.5 (24-18)					
					TTAT60075F5LR-B	R	●	0.4	0.05 Flat	20.0	8.0	2.5	0.2-0.75 (80-36)					
					TTAT60125V5LR-B	R	●	0.8	0.05	20.0	8.0	2.5	0.5-1.25 (40-16)					
					TTAT60075F5LL-B	L	●	0.4	0.05 Flat	20.0	8.0	2.5	0.2-0.75 (80-36)					
					TTAT60125V5LL-B	L	●	0.8	0.05	20.0	8.0	2.5	0.5-1.25 (40-16)					
					TTAT6015001LN-B	N	●	1.25	0.1	20.0	8.0	2.5	1.0-1.5 (24-18)					
					Right Hand (R)			General Purpose Partial Profile (55°)		TTAT55158V5RR-B	R	●	0.8	0.05	20.0	8.0	2.5	(40-16)
										TTAT55158V5RL-B	L	●	0.8	0.05	20.0	8.0	2.5	(40-16)
TTAT55158V5LR-B	R	●	0.8	0.05						20.0	8.0	2.5	(40-16)					
TTAT55158V5LL-B	L	●	0.8	0.05						20.0	8.0	2.5	(40-16)					

RECOMMENDED CUTTING CONDITIONS

Work Material	Hardness	Cutting Speed (m/min)
P Carbon Steel · Alloy Steel	180HB-280HB	100 (50-150)
Free Cutting Steel	—	110 (30-180)

Work Material	Hardness	Cutting Speed (m/min)
M Stainless Steel	≤200HB	80 (50-120)
N Non-Ferrous Metal	—	150 (70-230)

● : Inventory maintained. ★ : Inventory maintained in Japan.
(5 inserts in one case)

HOLDER APPLICATION

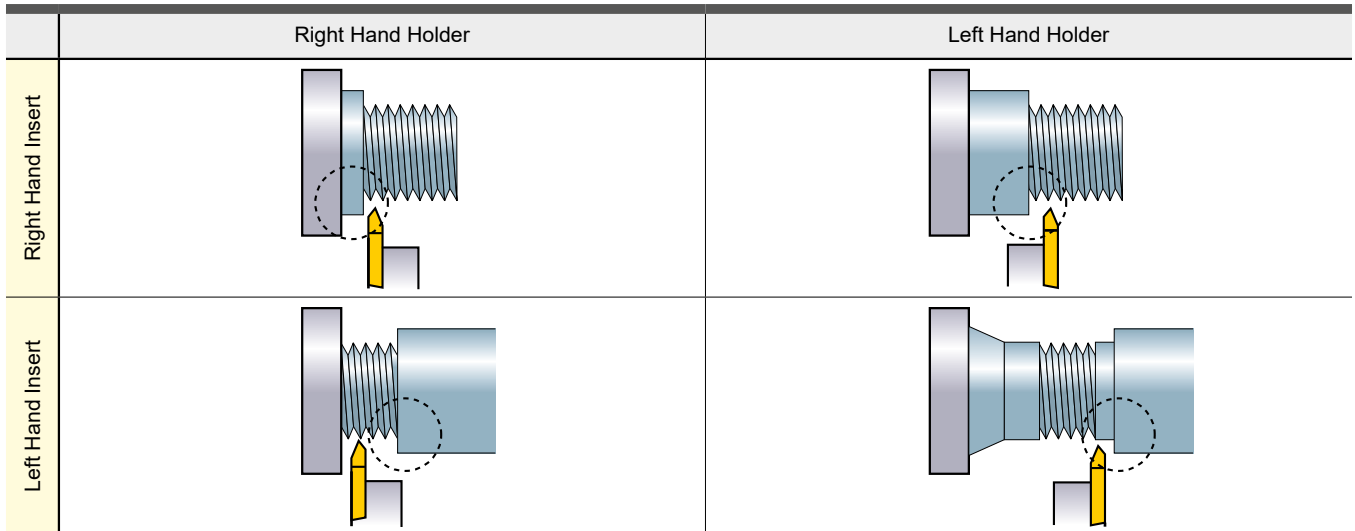

*The above combinations enable to machine the side of

D
SMALL TOOLS

THREAD RANGE

Application range

Pitch (mm)	Pitch Diameter of Thread (mm)										Number of Passes
	≥φ1.0	≥φ1.2	≥φ1.6	≥φ2.0	≥φ2.5	≥φ3.0	≥φ4.0	≥φ5.0	≥φ6.0	≥φ7.0	
0.2											2 – 4
0.25											3 – 5
0.3											4 – 6
0.35											5 – 7
0.4											6 – 8
0.45											
0.5											
0.6											
0.7											
0.75											
0.8											
1											
1.25											
1.5											

Threading impossible

*Metric Thread (60°)

Pitch(thread/inch)	Pitch Diameter of Thread									Number of Passes
Inch	≥φ0.060	≥φ0.073	≥φ0.086	≥φ0.099	≥φ0.112	≥φ0.164	≥φ0.190	≥φ0.250	≥φ0.313	
mm	≥φ1.524	≥φ1.854	≥φ2.184	≥φ2.515	≥φ2.845	≥φ4.166	≥φ4.826	≥φ6.350	≥φ7.938	
80										3 – 5
72										4 – 6
64										5 – 7
56										6 – 8
48										
44										
40										
32										
28										
26										
24										
20										
18										
16										

Threading impossible

*American UN, Whitworth

SPARE PARTS > N001
TECHNICAL DATA > P001

D025

EXTERNAL FRONT TURNING, COPYING, FACING (FOR OPPOSITE TOOL POSTS)

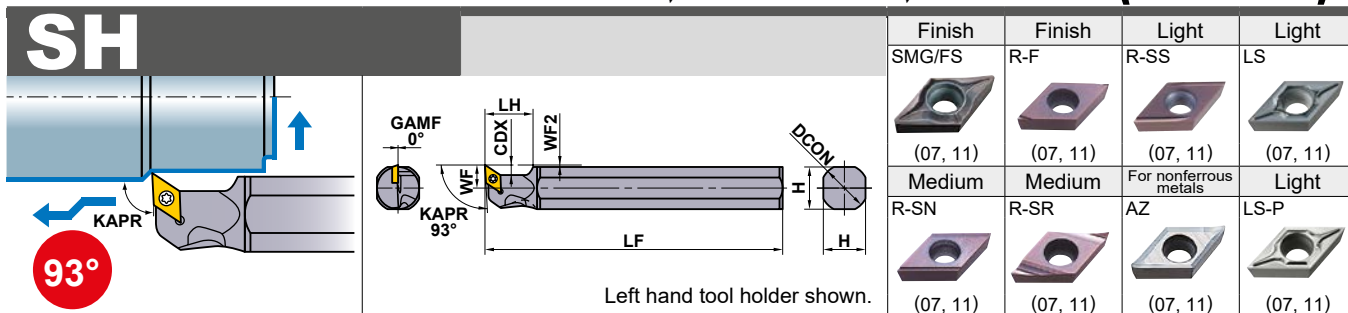

Left hand tool holder shown.

Order Number	Stock L	Insert Number	Dimensions (mm)								* Clamp Screw	Wrench
			DCON	LF	LH	H	WF	CDX	WF2			
SH16H-FSDUCL07	★	DCMT DCMW DCET DCGT DCGW	0702	15.875	100	20	14	7.75	4.2	0.75	TS254	TKY08R
SH19K-FSDUCL07	★			19.05	125	20	17	9.25	4.2	0.75	TS254	TKY08R
SH20K-FSDUCL07	★			20	125	20	18	9.75	4.2	0.75	TS254	TKY08R
SH22K-FSDUCL07	★			22	125	20	20	10.75	4.2	0.75	TS254	TKY08R
SH25M-FSDUCL07	★			25.4	150	20	23	12.25	4.2	0.75	TS254	TKY08R
SH16H-FSDUCL11	★	DCMT DCMW DCET DCGT DCGW	11T3	15.875	100	20	15	7.75	6.4	0.75	TS43	TKY15R
SH19K-FSDUCL11	★			19.05	125	20	17	9.25	6.4	0.75	TS43	TKY15R
SH20K-FSDUCL11	★			20	125	20	18	9.75	6.4	0.75	TS43	TKY15R
SH22K-FSDUCL11	★			22	125	20	20	10.75	6.4	0.75	TS43	TKY15R
SH25M-FSDUCL11	★			25.4	150	20	23	12.25	6.4	0.75	TS43	TKY15R

Note 1) When using insert with right and left hand chipbreaker, please use right hand insert.

Note 2) The insert photos are only examples. The letters refer to the chipbreaker and the dimension refers to the inscribed circle.

* Clamp Torque (N · m) : TS254=1.0, TS43=3.5

RECOMMENDED CUTTING CONDITIONS

Work Material	Hardness	Grade	Cutting Speed (m/min)	Feed (mm/rev)
P Carbon Steel · Alloy Steel	180HB-280HB	MS6015/VP15TF	100 (50-150)	0.08 (0.01-0.15)
		MS6015	110 (30-180)	0.08 (0.01-0.15)
	Free Cutting Steel	-	NX2525	150 (50-250)
M Stainless Steel	≤200HB	VP15TF/MP9005/MP9015	80 (50-120)	0.06 (0.02-0.1)
	230HB	MS9025	100 (50-180)	0.08 (0.01-0.15)
N Non-Ferrous Metal	-	HTi10/MT9005	150 (70-230)	0.09 (0.03-0.15)
S Titanium Alloy	-	MT9005	60 (40-80)	0.08 (0.04-0.12)
	-	MP9015/MS9025	50 (20-75)	0.08 (0.04-0.12)

★ : Inventory maintained in Japan.

SH type inserts

➤ A147-A152

CBN & PCD inserts

➤ B054, B055, B068

Memo

A series of horizontal dashed lines for writing.

HOW TO READ THE STANDARD OF BORING BARS

● How this section page is organised

- ① Organised by product series.
(Refer to the index on the next page.)

TYPE OF BORING BAR

Indicates the initial letters for the order number, as well as applicable insert types.

TITLE OF PRODUCT SERIES

PRODUCT SECTION

PRODUCT FEATURES

FIGURE SHOWING THE TOOLING APPLICATION
Uses illustrations and arrows to depict available machining applications along with cutting edge lead angles.

GEOMETRY

CHIPBREAKER BY CUTTING APPLICATION

BORING BARS

DIMPLE BAR

FSCL/P/E

Excellent vibration resistance due to light dimple head.
Chip disposal is improved by having thin channels for chip evacuation.
A laser printed scale on the side for easy installation (Steel shank).
Scale is 3 to 5 times the diameter. (Carbide shank is 3 to 8 times the diameter).

Order Number	Block	Insert Number	Dimensions (mm)							Minimum thread lead ratio	Wrench	
			DCON	LF	LDRED	WF	H	GAMP	DMIN			
FSCL1008RL-08E	●	0802	8	140	13.8	5	7.2	12*	10	7	TS23	TKY08F
FSCL1008R-08E-2/3	●	CC-B	8	90	13.8	5	7.2	12*	10	5	TS25	TKY08F
FSCL1008R-08E-1/2	●	CC-H	8	70	13.8	5	7.2	12*	10	3	TS25	TKY08F
FSCL1210RL-08E	●	0802	10	160	16.0	6	9	5*	12	7.5	TS20	TKY10F
FSCL1210R-08E-2/3	●	0802	10	105	16.0	6	9	5*	12	5	TS20	TKY10F
FSCL1210R-08E-1/2	●	0802	10	80	16.0	6	9	5*	12	3	TS20	TKY10F
FSCL1412RL-08E	●	0802	12	180	17.8	7	11	4*	14	8	TS20	TKY10F
FSCL1412R-08E-2/3	●	0802	12	120	17.8	7	11	4*	14	5	TS20	TKY10F
FSCL1412R-08E-1/2	●	0802	12	90	17.8	7	11	4*	14	3	TS20	TKY10F
FSCL1816RL-09E	●	0903	16	220	21.8	9	15	3.5*	18	8	TS40	TKY15F
FSCL1816R-09E-2/3	●	0903	16	145	21.8	9	15	3.5*	18	5	TS40	TKY15F
FSCL1816R-09E-1/2	●	0903	16	110	21.8	9	15	3.5*	18	3	TS40	TKY15F
FSCL2220RL-09E	●	0903	20	250	24.0	11	19	2*	22	8	TS40	TKY15F
FSCL2220R-09E-2/3	●	0903	20	165	24.0	11	19	2*	22	5	TS40	TKY15F
FSCL2220R-09E-1/2	●	0903	20	125	24.0	11	19	2*	22	3	TS40	TKY15F

*1 Clamp Torque (N·m) : TS23=1.0, TS20=0.6, TS25=1.0, TS10=2.5, TS40=3.5
*2 By changing the clamp screw, it is possible to use the different insert. Please refer to page E008.

BORING BARS

FSUP

Carbide shank with coolant hole

TP Inserts

Finish SV Light Medium

Order Number	Block	Insert Number	Dimensions (mm)							Minimum thread lead ratio	Wrench	
			DCON	LF	LDRED	WF	H	GAMP	DMIN			
FSUP1008RL-08A	●	0802	8	125	16	5	7.2	10*	10	3	TS20	TKY08F
FSUP1210RL-09A	●	0902	10	150	22.5	6	9	8*	12	3.5	TS20	TKY08F
FSUP1412RL-09A	●	0902	12	150	27	7	11	7*	14	4	TS20	TKY08F
FSUP1816RL-11A	●	1103	16	180	36	9	15	4*	18	5	TS30	TKY10F
FSUP2220RL-11A	●	1103	20	220	45	11	19	0*	22	5	TS30	TKY10F
FSUP3220RL-16A	●	1603	25	270	56.3	16	23.4	0*	32	5	TS40	TKY15F

*1 Clamp Torque (N·m) : TS20=0.6, TS25=1.0, TS10=2.5, TS40=3.5
*2 By changing the clamp screw, it is possible to use the different insert. Please refer to page E008.

LEGEND FOR STOCK STATUS MARK
Is shown on the left hand page of each double-page spread.

REFERENCE PAGE FOR APPLICABLE INSERTS
Indicates reference pages for details of inserts that are applicable to the title product.

PRODUCT STANDARDS
Indicates order numbers, stock status (per right/left hand), applicable inserts, dimensions, minimum cutting diameters, standard corner radius, recommended l/d ratios, and spare parts.

PAGE REFERENCE
- SPARE PARTS
- TECHNICAL DATA
Indicates reference pages, including the above, on the right hand page of each double-page spread.

MIN. CUTTING DIAMETER
Is colour-coded to let you find, at a glance, the maximum / minimum cutting diameters for internal machining.

TURNING TOOLS

BORING BARS

CLASSIFICATION OF BORING TOOLS.....	E002
IDENTIFICATION	E004

STANDARD OF BORING BARS











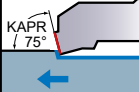
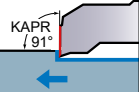
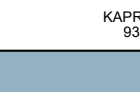
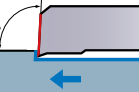



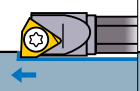
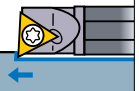

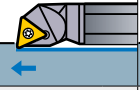

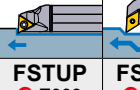
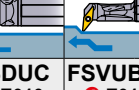
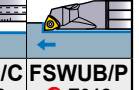



FEATURES OF DIMPLE BAR	E006
DIMPLE BAR.....	E007
DOUBLE CLAMP DIMPLE BAR.....	E015
MICRO-DEX BORING BARS.....	E018
MICRO-MINI TWIN BORING BARS	E021
MICRO-MINI BORING BARS.....	E024
F TYPE BORING BARS.....	E027
S TYPE BORING BARS.....	E030
P TYPE BORING BARS.....	E037
AL TYPE BORING BARS	E041



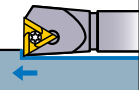

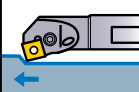
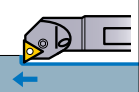
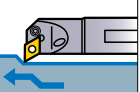
*Alphabetical order index

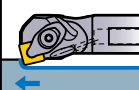
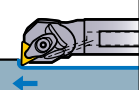
E015 A○○○-DCLN	E019 C○○○STUC	E020 RBH
E015 A○○○-DDUN	E034 C○○○SVQC	E025 RBH
E016 A○○○-DSKN	E018 C○○○SWUB	E032 S○○○SCLC
E016 A○○○-DTFN	E021 CB	E036 S○○○SCZC
E017 A○○○-DVUN	E022 CR	E033 S○○○SDQC
E017 A○○○-DWLN	E028 FCTU1	E031 S○○○SDUC
E038 A○○○PCLN	E028 FCTU2	E035 S○○○SSKC
E039 A○○○PDQN	E007 FSCLC/P	E030 S○○○STFC
E038 A○○○PDUN	E011 FSDQC	E041 S○○○STFE
E040 A○○○PDZN	E010 FSDUC	E034 S○○○SVQC
E037 A○○○PSKN	E027 FSTU1	E035 S○○○SVUC
E037 A○○○PTFN	E027 FSTU2	E026 SBH
E039 A○○○PWLN	E009 FSTUP	
E024 C○○○-BLS	E014 FSVJB/C	
E018 C○○○SCLC	E013 FSVPB/C	
E032 C○○○SCLC	E013 FSVUB/C	
E033 C○○○SDQC	E029 FSWL1	
E031 C○○○SDUC	E029 FSWL2	
E030 C○○○STFC	E012 FSWUB/P	

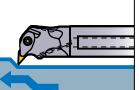
CLASSIFICATION

Name of Tool Holder	DMIN Minimum Cutting Diameter	Features	KAPR=75°		KAPR=91°	KAPR=93°			
									
MICRO-MINI TWIN Boring Bars 	φ2.2 – φ8.2	<ul style="list-style-type: none"> ● Solid carbide type with two cutting edges. ● Continuous cutting from boring to facing. ● With or without a chipbreaker. 							
MICRO-MINI Boring Bars 	φ3.2 – φ5.2	<ul style="list-style-type: none"> ● Solid carbide type (Single cutting edges). ● l/d is 5 times the diameter. ● Cutting edge can be shaped according to the application. Thus, it covers a wide cutting range (threading, grooving, copying, etc.). 							
MICRO-DEX Boring Bars (Carbide Shank) 	φ5 – φ8	<ul style="list-style-type: none"> ● 5°, 7° positive insert. ● Carbide shank type. ● Easy-to-use tool geometries. ● Suitable for small workpieces. ● l/d is 5 times the diameter. 							
F Type Boring Bars 	φ5.8 – φ40	<ul style="list-style-type: none"> ● 11° positive insert. ● Screw-on type and Clamp-on type. ● l/d is 3 to 5 times the diameter. ● FSWL type is 7° positive insert. 							
DIMPLE BAR 	φ10 – φ40	<ul style="list-style-type: none"> ● 5°, 7°, 11° positive inserts. ● Excellent vibration resistance due to a light dimple head. ● l/d is 3 to 5 times the diameter (Carbide shank is 3 to 8 times the diameter). 							
S Type Boring Bars 	φ11 – φ50	<ul style="list-style-type: none"> ● ISO standard. ● 7° positive insert. ● Screw-on type. ● l/d is 3 to 5 times the diameter (Carbide shank is 7 times the diameter). 							
AL Type Boring Bars (For Aluminium Alloy) 	φ20 – φ32	<ul style="list-style-type: none"> ● Suitable for non-ferrous metal. ● 20° positive insert. ● Screw-on type. ● l/d is 6 times the diameter. ● Excellent vibration resistance. 							
P Type Boring Bars 	φ20 – φ70	<ul style="list-style-type: none"> ● ISO standard. ● Economical negative insert. ● Lever lock type, and pin lock type. ● l/d is 3 times the diameter. 							
DOUBLE CLAMP DIMPLE BAR 	φ32 – φ50	<ul style="list-style-type: none"> ● Economical negative insert. ● Single action type. ● Excellent vibration resistance due to a light dimple head. (With coolant hole.) ● l/d is 3 to 4 times the diameter. 							

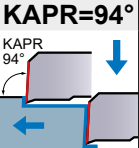
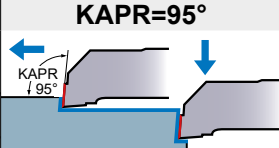
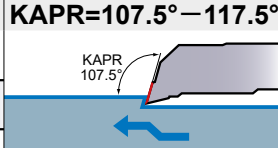
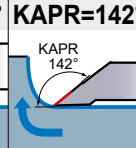
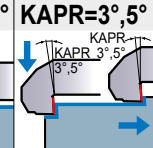
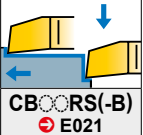
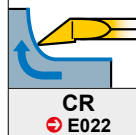
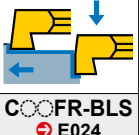
Note 1) Holders with blue colour symbol have an anti-vibration carbide shank. (Micro-dex boring bars are carbide shank only.)
 Note 2) l/d represents the ratio of the projection length L to the cutting edge and the shank diameter d.

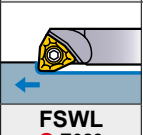
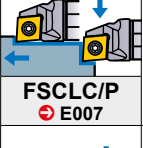
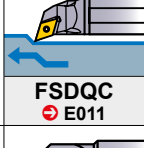
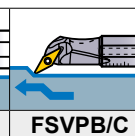
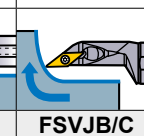
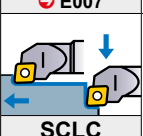
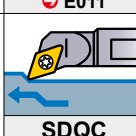
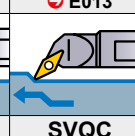
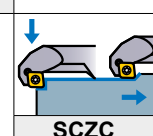
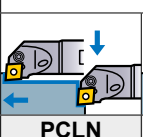
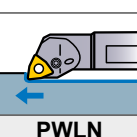
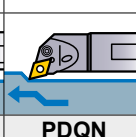
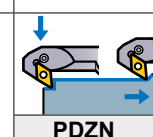
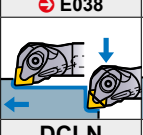
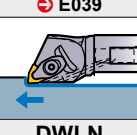
	KAPR=94°	KAPR=95°	KAPR=107.5°–117.5°	KAPR=142°	KAPR=3°, 5°	Selection Standard								
						Economical	Low Cutting Resistance (Sharp edge)	Clamp Rigidity	Vibration Resistance	Operation Efficiency	Coolant Hole	Specialized	Small Diameter Cutting	
														
		 CBORS(-B) E021		 CR E022			◎			◎*				◎
	 COFR-BLS E024						◎							◎
		 SCLC E018								◎*				◎
		 FSWL E029						○		○*				○
		 FSCLC/P E007	 FSDQC E011	 FSVPB/C E013	 FSVJB/C E014			◎		◎*	◎	◎*		
		 SCLC E032	 SDQC E033	 SVQC E034	 SCZC E036			○		○*				
								◎		○				◎
	 PCLN E038	 PWLN E039	 PDQN E039		 PDZN E040			◎		○		◎	◎	
	 DCLN E015	 DWLN E017												

Note 3) ◎: 1st recommendation. ○: 2nd recommendation.
 Note 4) * Indicates that the shank material is carbide.

IDENTIFICATION

■ ISO CODES KEY-Boring Tools for Internal Machining

BORING BARS

A	● Tool Holder with Coolant Hole ● Steel Shank
C	● Carbide Shank
E	● Tool Holder with Coolant Hole ● Carbide Shank
S	● Steel Shank

M	
P	
S	

08	ϕ 8	F	80
10	ϕ 10	H	100
12	ϕ 12	K	125
16	ϕ 16	M	150
20	ϕ 20	Q	180
25	ϕ 25	R	200
32	ϕ 32	S	250
40	ϕ 40	T	300
50	ϕ 50	U	350
		V	400

① Shank Material	② Shank Diameter DCON (mm)	③ Tool Length LF (mm)	④ Clamping Method
------------------	----------------------------	-----------------------	-------------------

S 16 M S C L C R 09

⑤ Insert Shape		⑥ Tool Style		⑦ Insert Normal Clearance		⑨ Insert Size											
C		F		C		C		D		S		T		V		W	
D		K		E		3.97	—	—	—	—	—	—	—	—	—	02	
S		L		N		4.76	—	—	—	—	—	—	—	—	—	—	
T		Q		P		5.56	—	—	—	09	—	—	—	—	—	L3	
V		U		⑧ Hand of Tool		6.35	06	07	—	11	11	—	—	—	—	—	
W		Z				R		7.94	08	—	—	—	—	—	—	—	—
				L		9.525	09	11	09	16	16	—	—	—	—	06	
						12.70	12	15	12	22	—	—	—	—	—	08	
						15.875	16	—	—	—	—	—	—	—	—	—	
						19.05	19	—	19	—	—	—	—	—	—	—	

■ DIMPLE BAR

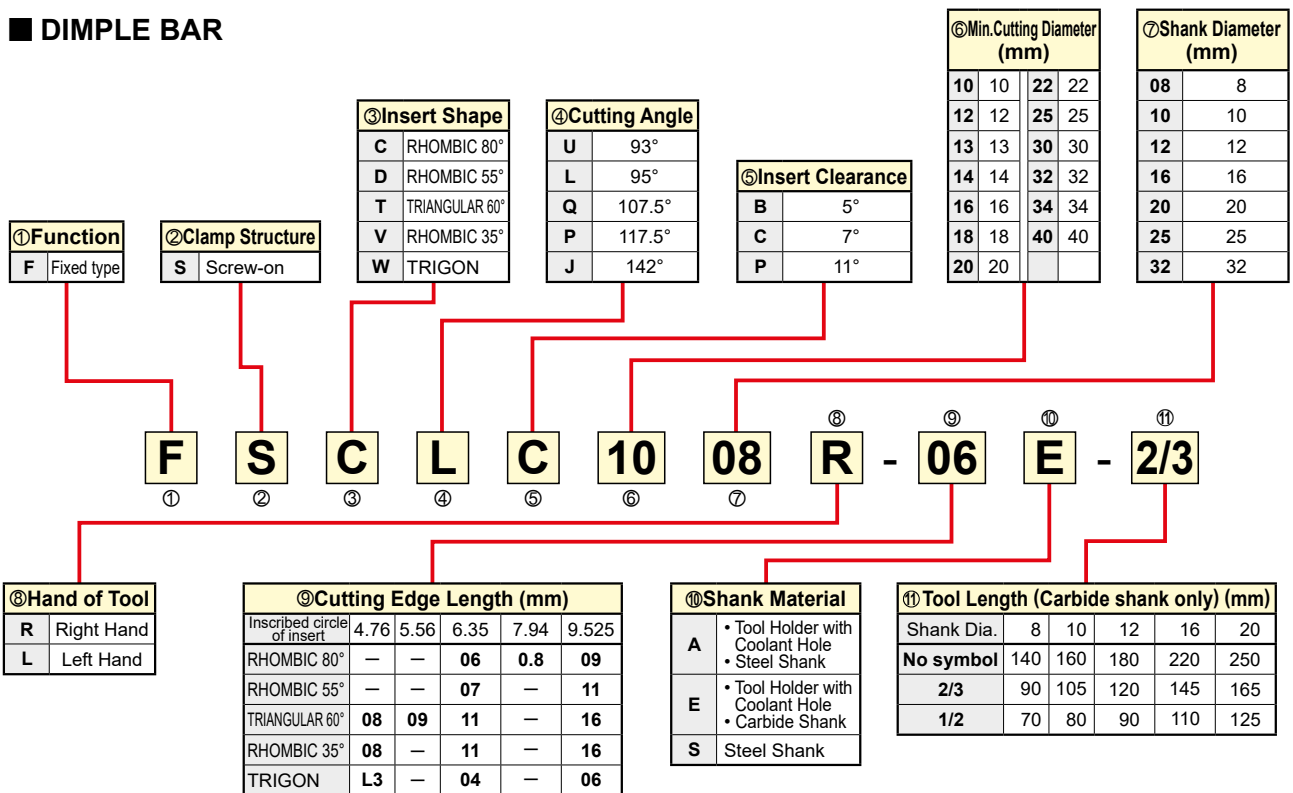

■ F TYPE Boring tools

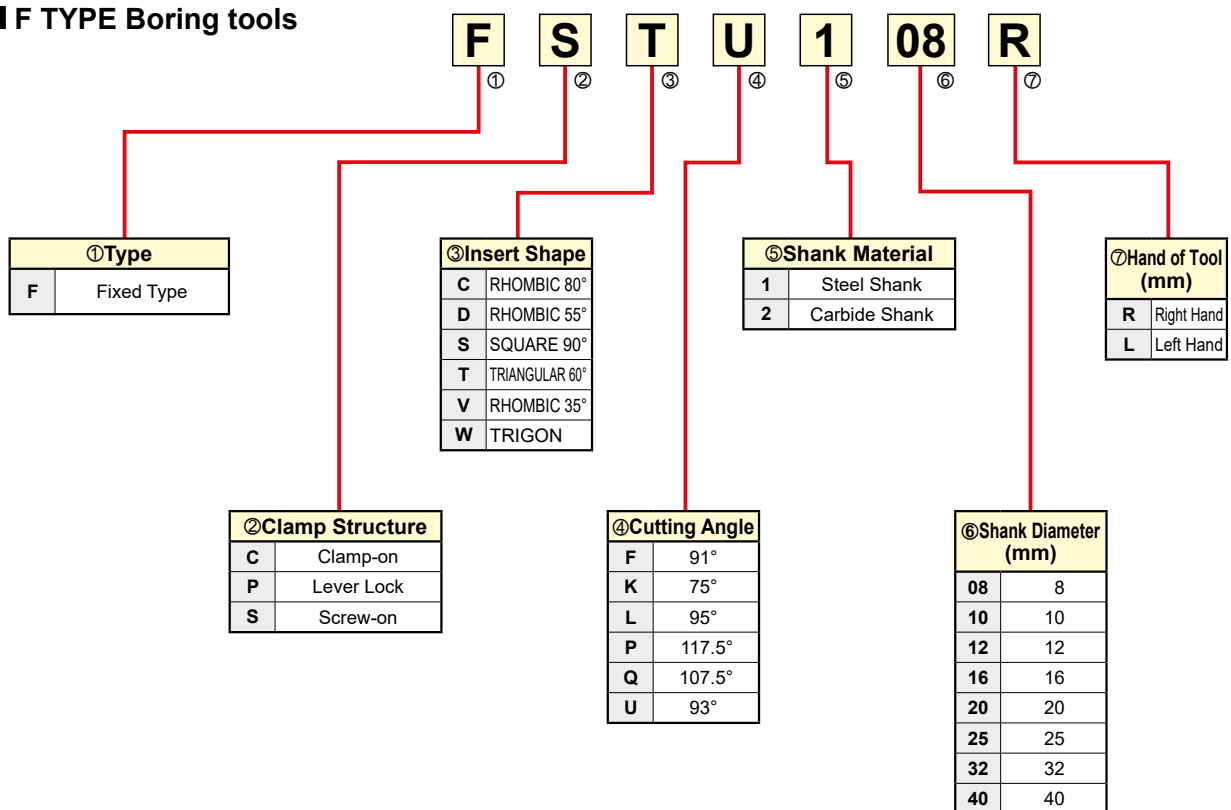

FEATURES OF DIMPLE BAR

Highly rigid steel shank and a lightweight head configuration. Designed by computer simulation analysis to reduce chatter and improve the vibration damping properties.

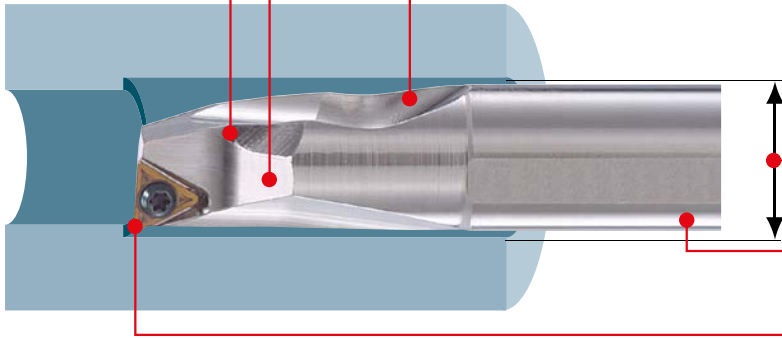

Chip disposal is improved by having two channels for chip evacuation.

The lightweight head with its large dimple reduces chatter.

Available in sizes smaller than the ISO standard. Therefore the boring of small diameter holes is possible.

The boring bar has a laser printed scale on the shank to facilitate easy installation.

"F and FS" breakers improve the quality of the surface finish, "MV" breaker offers excellent chip disposal. High wear resistant PCBN inserts are also available for the machining of hardened materials.

E

BORING BARS

■ VIBRATION RESISTANCE

● DIMPLE BAR

Weight of the Head	Damping Time
49.7g	15.8ms



By reducing the weight of the head, the damping properties are increased.

● Conventional Product

Weight of the Head	Damping Time
70.1g	20ms

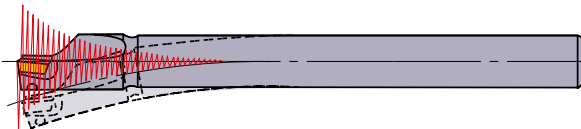

* The simulation data stated above was conducted with a FSCLP1816R-09A holder, under the following conditions; l/d=5, depth of cut=0.5mm, and feed=0.05mm/rev.

■ How to use CCG/MT•CPG/MT•CPMX•TPG/MX type inserts

By changing the clamp screw, it is possible to use the inserts listed in the table below.

Holder : FSCLC/P•FSCLC/P...E

Insert Number	Clamp Screw
CCG/MT0602 (φ6.35)	Can be used as it is.
CPG/MT0802 (φ7.94)	Change to TS3
CPG/MT0903 (φ9.525)	Change to TS4
CPMX0802 (φ7.94)	Can be used as it is.
CPMX0903 (φ9.525)	Can be used as it is.

Holder : FSTUP•FSTUP...E

Insert Number	Clamp Screw
TPG/MX0802 (φ4.76)	Change to CS200T
TPG/MX0902 (φ5.56)	Change to CS250T
TPG/MX1103 (φ6.35)	Change to CS300890T

* If the screw is too long the please shorten as necessary.

Note 1) TPMT/W09, W11 types cannot be used due to a different clamp screw size.

DIMPLE BAR

- Excellent vibration resistance due to the light dimple head.
- Chip disposal is improved by having two channels for chip evacuation.
- A laser printed scale on the side for easy installation (Steel shank).
- l/d is 3 to 5 times the diameter (Carbide shank is 3 to 8 times the diameter).

FSCLC/P

CC[○]inserts, CP[○]inserts

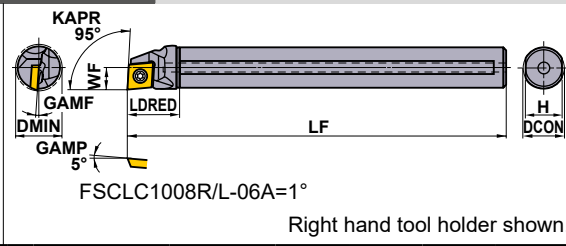
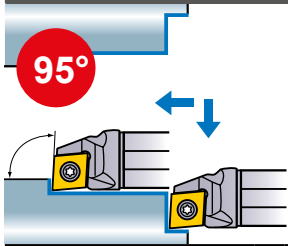

Finish	Finish	Finish	Light
FP (06)	FV (06,08,09)	FM (06)	SV (06,08,09)
Light	Medium	Medium	PCBN/PCD
LP (06)	MV (06,08,09)	MP (06)	(06,08,09)

Order Number	Coolant Hole	Stock		Insert Number	Dimensions (mm)						Maximum Recommendation l/d Ratio	*1			
		R	L		DCON	LF	LDRED	WF	H	GAMF		DMIN	Clamp Screw	Wrench	
FSCLC1008R/L-06A	○	●	●	CC [○] B/H/T/W	0602 [○]	8	125	18	5	7.2	12°	10	3	TS253	TKY08F
FSCLP1210R/L-08A	○	●	●	CPMB CPMH CPMT*2 CPMX*2 CPGB CPGT*2	0802 [○]	10	150	22.5	6	9	5°	12	3.5	TS3D	TKY10F
FSCLP1210R/L-08S	-	★	★		0802 [○]	10	150	22.5	6	9	5°	12	3.5	TS3D	TKY10F
FSCLP1412R/L-08A	○	●	●		0802 [○]	12	150	27	7	11	4°	14	4	TS3D	TKY10F
FSCLP1816R/L-09A	○	●	●		0903 [○]	16	180	36	9	15	3.5°	18	5	TS4D	TKY15F
FSCLP2220R/L-09A	○	●	●		0903 [○]	20	220	45	11	19	2°	22	5	TS4D	TKY15F
FSCLP2220R-09S	-	★			0903 [○]	20	220	45	11	19	2°	22	5	TS4D	TKY15F
FSCLP3025R/L-09A	○	●	●		0903 [○]	25	250	56.3	15	23.4	0°	30	5	TS4D	TKY15F
FSCLP3025R-09S	-	★			0903 [○]	25	250	56.3	15	23.4	0°	30	5	TS4D	TKY15F

*1 Clamp Torque (N • m) : TS253=1.0, TS3D=2.5, TS4D=3.5

*2 By changing the clamp screw, it is possible to use the different insert. Please refer to page E006.

Note 1) The insert photos are only examples. The letters refer to the chipbreaker and the dimension refers to the inscribed circle.

Note 2) When using insert with right and left hand chipbreaker, please use left hand insert for right hand holder and right hand insert for left hand holder.

- : Inventory maintained.
- ★ : Inventory maintained in Japan.

CC [○] type inserts	> A139 – A145
CP [○] type inserts	> A146
PCBN & PCD inserts	> B051 – B053, B067

CUTTING CONDITIONS	> E014
SPARE PARTS	> N001
TECHNICAL DATA	> P001

BORING BARS

DIMPLE BAR

- Excellent vibration resistance due to the light dimple head.
- Chip disposal is improved by having two channels for chip evacuation.
- A laser printed scale on the side for easy installation (Steel shank).
- l/d is 3 to 5 times the diameter (Carbide shank is 3 to 8 times the diameter).

F

SCLC/P.E

Carbide shank with coolant hole

CC[○] inserts, CP[○] inserts

Finish

FP	FV	FM	Light
(06)	(06,08,09)	(06)	(06,08,09)
Light	Medium	Medium	PCBN/PCD
LP	MV	MP	
(06)	(06,08,09)	(06)	(06,08,09)

FSCLC1008R/L-06E (-2/3, -1/2)=1°
Right hand tool holder shown.

Order Number	Stock		Insert Number	Dimensions (mm)							Maximum Recommendation l/d Ratio	*1		
	R	L		DCON	LF	LDRED	WF	H	GAMF	DMIN		Clamp Screw	Wrench	
FSCLC1008R/L-06E	●	●	CC [○] B	0602 [○]	8	140	13.8	5	7.2	12°	10	7	TS253	TKY08F
FSCLC1008R-06E-2/3	●		CC [○] H	0602 [○]	8	90	13.8	5	7.2	12°	10	5	TS253	TKY08F
FSCLC1008R-06E-1/2	●		CC [○] T	0602 [○]	8	70	13.8	5	7.2	12°	10	3	TS253	TKY08F
FSCLC1008R-06E-1/2	●		CC [○] W	0602 [○]	8	70	13.8	5	7.2	12°	10	3	TS253	TKY08F
FSCLP1210R/L-08E	●	●	CPMB CPMH CPMT *2 CPMX *2 CPGB CPGT *2	0802 [○]	10	160	16.0	6	9	5°	12	7.5	TS3D	TKY10F
FSCLP1210R-08E-2/3	●			0802 [○]	10	105	16.0	6	9	5°	12	5	TS3D	TKY10F
FSCLP1210R-08E-1/2	●			0802 [○]	10	80	16.0	6	9	5°	12	3	TS3D	TKY10F
FSCLP1412R/L-08E	●	●		0802 [○]	12	180	17.8	7	11	4°	14	8	TS3D	TKY10F
FSCLP1412R-08E-2/3	●			0802 [○]	12	120	17.8	7	11	4°	14	5	TS3D	TKY10F
FSCLP1412R-08E-1/2	●			0802 [○]	12	90	17.8	7	11	4°	14	3	TS3D	TKY10F
FSCLP1816R/L-09E	●	●		0903 [○]	16	220	21.8	9	15	3.5°	18	8	TS4D	TKY15F
FSCLP1816R-09E-2/3	●			0903 [○]	16	145	21.8	9	15	3.5°	18	5	TS4D	TKY15F
FSCLP1816R-09E-1/2	●			0903 [○]	16	110	21.8	9	15	3.5°	18	3	TS4D	TKY15F
FSCLP2220R/L-09E	●	●		0903 [○]	20	250	24.0	11	19	2°	22	8	TS4D	TKY15F
FSCLP2220R-09E-2/3	★			0903 [○]	20	165	24.0	11	19	2°	22	5	TS4D	TKY15F
FSCLP2220R-09E-1/2	★			0903 [○]	20	125	24.0	11	19	2°	22	3	TS4D	TKY15F

*1 Clamp Torque (N · m) : TS253=1.0, TS3D=2.5, TS4D=3.5

*2 By changing the clamp screw, it is possible to use the different insert. Please refer to page E006.

Note 1) The insert photos are only examples. The letters refer to the chipbreaker and the dimension refers to the inscribed circle.

Note 2) Dimensions shown for insert corner RE 0.4. (Model of ☆ Mark is RE 0.8)

Note 3) When using insert with right and left hand chipbreaker, please use left hand insert for right hand holder and right hand insert for left hand holder.

● : Inventory maintained. ★ : Inventory maintained in Japan.

CC [○] type inserts	> A139—A145
CP [○] type inserts	> A146
PCBN & PCD inserts	> B051—B053, B067

FSTUP

With coolant hole TP $\odot\odot$ inserts

Finish	Light	Medium
FV (08,09,11,16)	SV (08,09,11,16)	MV (08,09,11,16)
PCD	PCBN	
R/L-F (08,09,11,16)	 (08,09,11,16)	

Right hand tool holder shown.

Order Number	Stock		Insert Number	Dimensions (mm)							Maximum Recommendation l/d Ratio	*1		
	R	L		DCON	LF	LDRED	WF	H	GAMF	DMIN		Clamp Screw	Wrench	
FSTUP1008R/L-08A	●	●	TPMB TPMH TPMX*2 TPGB TPGH TPGX*2	0802 $\odot\odot$	8	125	18	5	7.2	10°	10	3	TS2D	TKY06F
FSTUP1210R/L-09A	●	●		0902 $\odot\odot$	10	150	22.5	6	9	8°	12	3.5	TS25D	TKY08F
FSTUP1412R/L-09A	●	●		0902 $\odot\odot$	12	150	27	7	11	7°	14	4	TS25D	TKY08F
FSTUP1816R/L-11A	●	●		1103 $\odot\odot$	16	180	36	9	15	4°	18	5	TS31D	TKY10F
FSTUP2220R/L-11A	●	●		1103 $\odot\odot$	20	220	45	11	19	0°	22	5	TS31D	TKY10F
FSTUP3225R/L-16A [*]	●	●		1603 $\odot\odot$	25	270	56.3	16	23.4	0°	32	5	TS4D	TKY15F

*1 Clamp Torque (N · m) : TS2D=0.6, TS25D=1.0, TS31D=2.5, TS4D=3.5

*2 By changing the clamp screw, it is possible to use the different insert. Please refer to page E006.

FSTUP_E

Carbide shank with coolant hole TP $\odot\odot$ inserts

Finish	Light	Medium
FV (08,09,11)	SV (08,09,11)	MV (08,09,11)
PCD	PCBN	
R/L-F (08,09,11)	 (08,09,11)	

Right hand tool holder shown.

Order Number	Stock		Insert Number	Dimensions (mm)							Maximum Recommendation l/d Ratio	*1		
	R	L		DCON	LF	LDRED	WF	H	GAMF	DMIN		Clamp Screw	Wrench	
FSTUP1008R/L-08E	●	●	TPMB TPMH TPMX*2 TPGB TPGH TPGX*2	0802 $\odot\odot$	8	140	13.8	5	7.2	10°	10	7	TS2D	TKY06F
FSTUP1008R-08E-2/3	●	●		0802 $\odot\odot$	8	90	13.8	5	7.2	10°	10	5	TS2D	TKY06F
FSTUP1008R-08E-1/2	●	●		0802 $\odot\odot$	8	70	13.8	5	7.2	10°	10	3	TS2D	TKY06F
FSTUP1210R/L-09E	●	●		0902 $\odot\odot$	10	160	16.0	6	9	8°	12	7.5	TS25D	TKY08F
FSTUP1210R-09E-2/3	●	●		0902 $\odot\odot$	10	105	16.0	6	9	8°	12	5	TS25D	TKY08F
FSTUP1210R-09E-1/2	●	●		0902 $\odot\odot$	10	80	16.0	6	9	8°	12	3	TS25D	TKY08F
FSTUP1412R/L-09E	●	●		0902 $\odot\odot$	12	180	17.8	7	11	7°	14	8	TS25D	TKY08F
FSTUP1412R-09E-2/3	●	●		0902 $\odot\odot$	12	120	17.8	7	11	7°	14	5	TS25D	TKY08F
FSTUP1412R-09E-1/2	●	●		0902 $\odot\odot$	12	90	17.8	7	11	7°	14	3	TS25D	TKY08F
FSTUP1816R/L-11E	●	●		1103 $\odot\odot$	16	220	21.8	9	15	4°	18	8	TS31D	TKY10F
FSTUP1816R-11E-2/3	●	●		1103 $\odot\odot$	16	145	21.8	9	15	4°	18	5	TS31D	TKY10F
FSTUP1816R-11E-1/2	●	●		1103 $\odot\odot$	16	110	21.8	9	15	4°	18	3	TS31D	TKY10F
FSTUP2220R/L-11E	●	●		1103 $\odot\odot$	20	250	24.0	11	19	0°	22	8	TS31D	TKY10F
FSTUP2220R-11E-2/3	●	●		1103 $\odot\odot$	20	165	24.0	11	19	0°	22	5	TS31D	TKY10F
FSTUP2220R-11E-1/2	●	●		1103 $\odot\odot$	20	125	24.0	11	19	0°	22	3	TS31D	TKY10F

*1 Clamp Torque (N · m) : TS2D=0.6, TS25D=1.0, TS31D=2.5

*2 By changing the clamp screw, it is possible to use the different insert. Please refer to page E006.

TP $\odot\odot$ type inserts > A162, A163
PCBN & PCD inserts > B057, B058, B070

CUTTING CONDITIONS > E014
SPARE PARTS > N001
TECHNICAL DATA > P001

BORING BARS

DIMPLE BAR

- Excellent vibration resistance due to the light dimple head.
- Chip disposal is improved by having two channels for chip evacuation.
- A laser printed scale on the side for easy installation (Steel shank).
- l/d is 3 to 5 times the diameter (Carbide shank is 3 to 8 times the diameter).

FSDUC		DC \odot inserts										Finish		Finish		Light		Light			
		Right hand tool holder shown.										FP	FM	LP	LM	Medium		Medium		PCD	
Order Number	Coolant Hole	Stock		Insert Number	Dimensions (mm)							Maximum Recommendation l/d Ratio	*								
		R	L		DCON	LF	LDRED	WF	WF2	H	GAMF		DMIN	Clamp Screw	Wrench						
FSDUC1410R/L-07A	○	●	●	DCMT DCMW DCGT DCGW	0702 \odot	10	150	18	8.3	3.3	9	7.5°	14	3.5	TS25	TKY08F					
NEW FSDUC1410L-07S	—	★	—		0702 \odot	10	150	18	8.3	3.3	9	7.5°	14	3.5	TS25	TKY08F					
FSDUC1612R/L-07A	○	●	●		0702 \odot	12	150	20	9.3	3.3	11	6°	16	4	TS25	TKY08F					
FSDUC2016R/L-07A	○	●	●		0702 \odot	16	180	20	11.3	3.3	15	5°	20	5	TS25	TKY08F					
FSDUC3220R/L-11A [☆]	○	●	●		11T3 \odot	20	180	22.5	16.1	6.1	19	5°	32	5	TS43	TKY15F					

* Clamp Torque (N · m) : TS25=1.0, TS43=3.5

FSDUC _E		Carbide shank with coolant hole DC \odot inserts										Finish		Finish		Light		Light					
Right hand tool holder shown.		Right hand tool holder shown.										FP	FM	LP	LM	Medium		Medium		PCD		PCBN	
Order Number	Coolant Hole	Stock		Insert Number	Dimensions (mm)							Maximum Recommendation l/d Ratio	*										
		R	L		DCON	LF	LDRED	WF	WF2	H	GAMF		DMIN	Clamp Screw	Wrench								
FSDUC1410R/L-07E	○	●	★	DCMT DCMW DCGT DCGW	0702 \odot	10	160	16.0	8.3	3.3	9	7.5°	14	7.5	TS25	TKY08F							
FSDUC1612R/L-07E	○	●	★		0702 \odot	12	180	17.8	9.3	3.3	11	6.0°	16	8	TS25	TKY08F							
FSDUC2016R/L-07E	○	●	★		0702 \odot	16	220	21.8	11.3	3.3	15	5.0°	20	8	TS25	TKY08F							
FSDUC3220R/L-11E [☆]	○	●	★		11T3 \odot	20	250	24.0	16.1	6.1	19	5.0°	32	8	TS43	TKY15F							

* Clamp Torque (N · m) : TS25=1.0, TS43=3.5

Note 1) The insert photos are only examples. The letters refer to the chipbreaker and the dimension refers to the inscribed circle.

Note 2) Dimensions shown for insert corner RE 0.4. (Model of ☆ Mark is RE 0.8)

Note 3) When using insert with right and left hand chipbreaker, please use left hand insert for right hand holder and right hand insert for left hand holder.

● : Inventory maintained. ★ : Inventory maintained in Japan.

DC \odot type inserts > A147–A152
PCBN & PCD inserts > B054, B055, B068

FSDQC			With coolant hole DC \odot inserts									Finish	Finish	Light	Light
			FP	FM	LP	LM									
												(07,11)	(07,11)	(07,11)	(07,11)
			Medium	Medium	PCD	PCBN									
												(07,11)	(07,11)	(07,11)	(07,11)
Order Number	Stock		Insert Number	Dimensions (mm)								Maximum Recommendation l/d Ratio	*		
	R	L		DCON	LF	LDRED	WF	WF2	H	GAMP	DMIN		Clamp Screw	Wrench	
FSDQC1310R/L-07A	●	●	DCMT DCMW DCGT DCGW	0702 \odot	10	150	20.5	7.6	2.6	9	8°	13	3.5	TS25	TKY08F
FSDQC1612R/L-07A	●	●		0702 \odot	12	150	22.5	8.6	2.6	11	6°	16	4	TS25	TKY08F
FSDQC2016R/L-07A	●	●		0702 \odot	16	180	22.5	10.6	2.6	15	5°	20	5	TS25	TKY08F
FSDQC2520R/L-11A [☆]	●	●		11T3 \odot	20	180	26	13.7	3.7	19	7°	25	5	TS43	TKY15F

* Clamp Torque (N • m) : TS25=1.0, TS43=3.5

FSDQC_E			Carbide shank with coolant hole DC \odot inserts									Finish	Finish	Light	Light
			FP	FM	LP	LM									
												(07,11)	(07,11)	(07,11)	(07,11)
			Medium	Medium	PCD	PCBN									
												(07,11)	(07,11)	(07,11)	(07,11)
Order Number	Stock		Insert Number	Dimensions (mm)								Maximum Recommendation l/d Ratio	*		
	R	L		DCON	LF	LDRED	WF	WF2	H	GAMP	DMIN		Clamp Screw	Wrench	
FSDQC1310R/L-07E	●	●	DCMT DCMW DCGT DCGW	0702 \odot	10	162	18.4	7.6	2.6	9	8°	13	7.5	TS25	TKY08F
FSDQC1612R/L-07E	●	●		0702 \odot	12	182	20.2	8.6	2.6	11	6°	16	8	TS25	TKY08F
FSDQC2016R/L-07E	●	●		0702 \odot	16	222	24.2	10.6	2.6	15	5°	20	8	TS25	TKY08F
FSDQC2520R/L-11E [☆]	●	●		11T3 \odot	20	254	28.0	13.7	3.7	19	7°	25	8	TS43	TKY15F

* Clamp Torque (N • m) : TS25=1.0, TS43=3.5

E

BORING BARS

DC \odot type inserts > A147–A152
PCBN & PCD inserts > B054, B055, B068

CUTTING CONDITIONS > E014
SPARE PARTS > N001
TECHNICAL DATA > P001

E011

BORING BARS

DIMPLE BAR

- Excellent vibration resistance due to the light dimple head.
- Chip disposal is improved by having two channels for chip evacuation.
- A laser printed scale on the side for easy installation (Steel shank).
- l/d is 3 to 5 times the diameter (Carbide shank is 3 to 8 times the diameter).



FSWUB/P

With coolant hole

WB○ inserts, WP○ inserts

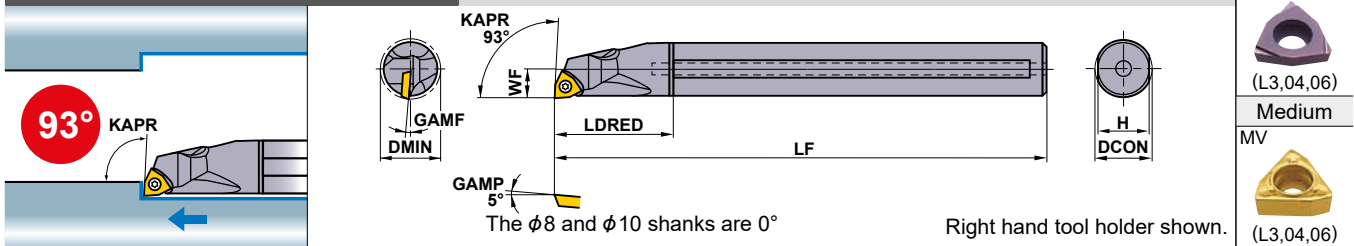
Finish
R/L-F-FS



Order Number	Stock		Insert Number	Dimensions (mm)							Maximum Recommendation l/d Ratio	*  		
	R	L		DCON	LF	LDRED	WF	H	GAMP	DMIN		Clamp Screw	Wrench	
FSWUB1008R/L-L3A ^{☆1}	●	●	WBMT WBGT	L302○	8	125	18	5	7.2	14°	10	3	TS2	TKY06F
FSWUB1210R/L-L3A ^{☆1}	●	●		L302○	10	150	22.5	6	9	11°	12	3.5	TS2	TKY06F
FSWUP1412R/L-04A	●	●	WPMT WPGT	0402○	12	150	27	7	11	4°	14	4	TS253	TKY08F
FSWUP1816R/L-04A	●	●		0402○	16	180	36	9	15	1°	18	5	TS253	TKY08F
FSWUP2220R/L-06A ^{☆2}	●	●		0603○	20	220	45	11	19	2°	22	5	TS4	TKY15F
FSWUP3025R/L-06A ^{☆2}	●	●		0603○	25	250	56.3	15	23.4	0°	30	5	TS4	TKY15F

* Clamp Torque (N · m) : TS2=0.6, TS253=1.0, TS4=3.5



FSWUB/P_E

Carbide shank with coolant hole

WB○ inserts, WP○ inserts

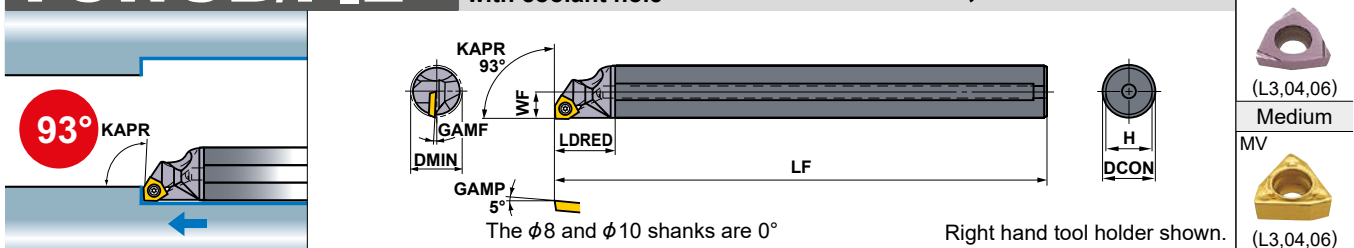
Finish
R/L-F-FS



Order Number	Stock		Insert Number	Dimensions (mm)							Maximum Recommendation l/d Ratio	*  		
	R	L		DCON	LF	LDRED	WF	H	GAMP	DMIN		Clamp Screw	Wrench	
FSWUB1008R/L-L3E ^{☆1}	★	★	WBMT WBGT	L302○	8	140	13.8	5	7.2	14°	10	7	TS2	TKY06F
FSWUB1008R-L3E-2/3 ^{☆1}	★			L302○	8	90	13.8	5	7.2	14°	10	5	TS2	TKY06F
FSWUB1008R-L3E-1/2 ^{☆1}	★			L302○	8	70	13.8	5	7.2	14°	10	3	TS2	TKY06F
FSWUB1210R/L-L3E ^{☆1}	★	★		L302○	10	160	16.0	6	9	11°	12	7.5	TS2	TKY06F
FSWUB1210R-L3E-2/3 ^{☆1}	★			L302○	10	105	16.0	6	9	11°	12	5	TS2	TKY06F
FSWUB1210R-L3E-1/2 ^{☆1}	★			L302○	10	80	16.0	6	9	11°	12	3	TS2	TKY06F
FSWUP1412R/L-04E	★	★	WPMT WPGT	0402○	12	180	17.8	7	11	4°	14	8	TS253	TKY08F
FSWUP1412R-04E-2/3	★			0402○	12	120	17.8	7	11	4°	14	5	TS253	TKY08F
FSWUP1412R-04E-1/2	★			0402○	12	90	17.8	7	11	4°	14	3	TS253	TKY08F
FSWUP1816R/L-04E	★	★		0402○	16	220	21.8	9	15	1°	18	8	TS253	TKY08F
FSWUP1816R-04E-2/3	★			0402○	16	145	21.8	9	15	1°	18	5	TS253	TKY08F
FSWUP1816R-04E-1/2	★			0402○	16	110	21.8	9	15	1°	18	3	TS253	TKY08F
FSWUP2220R/L-06E ^{☆2}	★	★		0603○	20	250	24.0	11	19	2°	22	8	TS4	TKY15F
FSWUP 2220R-06E-2/3 ^{☆2}	★			0603○	20	165	24.0	11	19	2°	22	5	TS4	TKY15F
FSWUP 2220R-06E-1/2	★			0603○	20	125	24.0	11	19	2°	22	3	TS4	TKY15F

* Clamp Torque (N · m) : TS2=0.6, TS253=1.0, TS4=3.5

Note 1) The insert photos are only examples. The letters refer to the chipbreaker and the dimension refers to the inscribed circle.

Note 2) Dimensions shown for insert corner RE 0.4. (Model of ☆1 Mark is RE 0.2, Model of ☆2 Mark is RE 0.8)

Note 3) When using insert with right and left hand chipbreaker, please use left hand insert for right hand holder and right hand insert for left hand holder.

● : Inventory maintained. ★ : Inventory maintained in Japan.

WB○ type inserts > A172
WP○ type inserts > A174
PCD inserts > B072

FSVUB/C		VC \odot inserts, VB \odot inserts										Finish	Finish	Light	Light			
												FP	FM	LP	LM			
												(11,16)	(11,16)	(11,16)	(11,16)			
												Medium	Medium	Medium	PCBN			
												MP	MM	Standard				
												(16)	(16)	(16)	(11,16)			
Order Number	Coolant Hole	Stock		Insert Number	Dimensions (mm)							Maximum Recommendation l/d Ratio	Shim	Shim Pin	Clamp Screw*	Wrench		
		R	L		DCON	LF	LDRED	WF	WF2	H	GAMF						DMIN	
FSVUC1612R/L-08A	○	●	●	VCGT VCMT	0802 \odot	12	150	25	11	5.5	11	8°	16	4	—	—	TS202	TKY06F
FSVUB2016R/L-11A	○	●	●		1103 \odot	16	180	32.5	15.5	8	15	8°	20	5	—	—	TS255	TKY08F
FSVUB2520R/L-11A	○	●	●	VBMT VBMW VBET	1103 \odot	20	200	40.5	17.5	8	19	7°	25	5	—	—	TS255	TKY08F
FSVUB2520R-11S	—	★			1103 \odot	20	200	40.5	17.5	8	19	7°	25	5	—	—	TS255	TKY08F
FSVUB3425R/L-16A $\star 2$	○	●	●	VBGW	1604 \odot	25	220	50	20.5	8.5	23.4	13°	34	5	SPSVN32	BCP141	TS35D	TKY15F
FSVUB4032R/L-16A $\star 2$	○	●	●		1604 \odot	32	250	84.0	27.5	12	30.4	9°	40	5	SPSVN32	BCP141	TS35D	TKY15F

* Clamp Torque (N · m) : TS202=0.6, TS255=1.0, TS35D=3.5

FSVVPB/C		VC \odot inserts, VB \odot inserts										Finish	Finish	Light	Light			
												FP	FM	LP	LM			
												(11,16)	(11,16)	(11,16)	(11,16)			
												Medium	Medium	Medium	PCBN			
												MP	MM	Standard				
												(16)	(16)	(16)	(11,16)			
Order Number	Coolant Hole	Stock		Insert Number	Dimensions (mm)							Maximum Recommendation l/d Ratio	Shim	Shim Pin	Clamp Screw*	Wrench		
		R	L		DCON	LF	LDRED	WF	WF2	H	GAMF						DMIN	
FSVPC1610R/L-08A	○	●	●	VCGT VCMT	0802 \odot	10	150	25	8	3	9	8°	16	3.5	—	—	TS202	TKY06F
FSVVPB2012R/L-11A	○	●	●		1103 \odot	12	150	28	10	4.5	11	8°	20	4	—	—	TS255	TKY08F
FSVVPB2516R/L-11A	○	●	●	VBMT VBMW VBET	1103 \odot	16	180	35	12.5	5	15	5°	25	5	—	—	TS255	TKY08F
NEW FSVVPB3020R-11S	—	★			1103 \odot	20	200	40	15	5	19	5°	30	5	—	—	TS255	TKY08F
FSVVPB3425R/L-16A $\star 2$	○	●	●	VBGW	1604 \odot	25	220	50	17	5	23.4	13°	34	5	SPSVN32	BCP141	TS35D	TKY15F
FSVVPB4032R/L-16A $\star 2$	○	●	●		1604 \odot	32	250	55	22	6.5	30.4	9°	40	5	SPSVN32	BCP141	TS35D	TKY15F

* Clamp Torque (N · m) : TS202=0.6, TS255=1.0, TS35D=3.5

VB \odot type inserts	> A164 – A166
VC \odot type inserts	> A167 – A169
PCBN & PCD inserts	> B059, B071

CUTTING CONDITIONS	> E014
SPARE PARTS	> N001
TECHNICAL DATA	> P001

BORING BARS



DIMPLE BAR

- Excellent vibration resistance due to the light dimple head.
- Chip disposal is improved by having two channels for chip evacuation.
- A laser printed scale on the side for easy installation (Steel shank).
- l/d is 3 to 5 times the diameter.

FSVJB/C

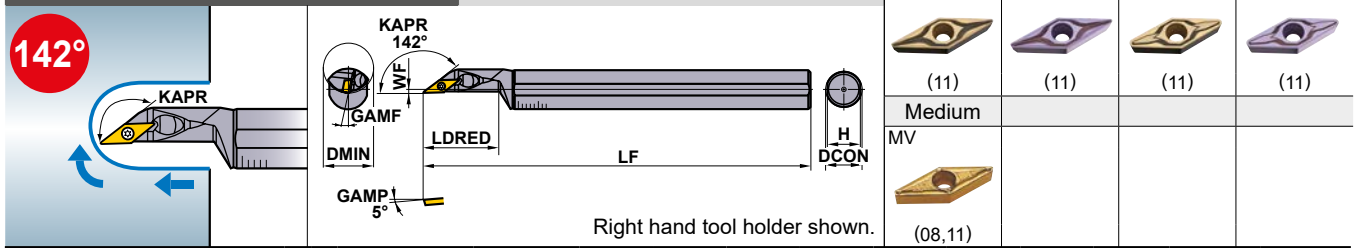
VC \odot inserts, VB \odot inserts



Order Number	Stock		Insert Number	Dimensions (mm)							Maximum Recommendation l/d Ratio	*  		
	R	L		DCON	LF	LDRED	WF	H	GAMP	DMIN		Clamp Screw	Wrench	
FSVJC1612R/L-08S ☆	●	●	VCGT VCMT	0802 \odot	12	150	26	2	11	5°	16	4	TS202	TKY06F
FSVJC2016R/L-08S ☆	●	●	VCMT	0802 \odot	16	180	36	2	15	5°	20	5	TS202	TKY06F
FSVJB2520R/L-11S ☆	●	●	VBMT VBMW	1103 \odot	20	200	37.5	2	19	5°	25	5	TS255	TKY08F
FSVJB3025R/L-11S ☆	●	●	VBET VBGW	1103 \odot	25	250	45	3.5	23.4	5°	30	5	TS255	TKY08F

* Clamp Torque (N · m) : TS202=0.6, TS255=1.0

E

BORING BARS

RECOMMENDED CUTTING CONDITIONS

Work Material	Properties	Cutting Mode	Chipbreaker	Recom- mendation	Cutting Speed (m/min)	L/D ≤ 3 (Steel shank)		L/D ≤ 4-5 (Steel shank)		
						Feed (mm/rev)	Depth of Cut (mm)	Feed (mm/rev)	Depth of Cut (mm)	
P Mild Steel	≤180HB	Finish	FP	FV	NX2525	170 (120-220)	0.10 (0.05-0.15)	-0.5	0.10 (0.05-0.15)	-0.5
			LP	SV	MP3025	150 (100-200)	0.20 (0.10-0.25)	-1.0	0.15 (0.05-0.20)	-1.0
		Light	LP	SV	NX2525	160 (110-210)	0.20 (0.10-0.25)	-1.0	0.15 (0.05-0.20)	-1.0
			SV	-	NX3035	150 (100-200)	0.20 (0.10-0.25)	-1.0	0.15 (0.05-0.20)	-1.0
		Medium	MP	MV	MP3025	140 (90-190)	0.25 (0.15-0.35)	-2.0	0.20 (0.15-0.25)	-1.5
			MP	MV	NX2525	150 (100-200)	0.25 (0.15-0.35)	-2.0	0.20 (0.15-0.25)	-1.5
Carbon Steel Alloy Steel	180-350HB	Finish	FP	-	MC6115	140 (90-190)	0.10 (0.05-0.15)	-0.5	0.10 (0.05-0.15)	-0.5
			FV	-	VP15TF	140 (90-190)	0.10 (0.05-0.15)	-0.5	0.10 (0.05-0.15)	-0.5
		Light	FP	FV	NX2525	130 (80-180)	0.10 (0.05-0.15)	-0.5	0.10 (0.05-0.15)	-0.5
			LP	SV	MC6125	140 (90-190)	0.20 (0.10-0.25)	-1.0	0.15 (0.05-0.20)	-1.0
		Medium	LP	SV	MP3025	110 (60-160)	0.20 (0.10-0.25)	-1.0	0.15 (0.05-0.20)	-1.0
			SV	-	NX3035	110 (60-160)	0.20 (0.10-0.25)	-1.0	0.15 (0.05-0.20)	-1.0
M Stainless Steel	≤200HB	Finish	MP	MV	MC6125	130 (80-180)	0.25 (0.15-0.35)	-2.0	0.20 (0.15-0.25)	-1.5
			MP	MV	MP3025	100 (60-150)	0.25 (0.15-0.35)	-2.0	0.20 (0.15-0.25)	-1.5
		Light	MV	-	NX3035	100 (60-150)	0.25 (0.15-0.35)	-2.0	0.20 (0.15-0.25)	-1.5
			FM	FV	VP15TF	150 (110-190)	0.10 (0.05-0.15)	-0.5	0.10 (0.05-0.15)	-0.5
		Medium	LM	-	MC7025	125 (85-165)	0.20 (0.10-0.25)	-1.0	0.15 (0.05-0.20)	-1.0
			SV	-	US735	125 (85-165)	0.20 (0.10-0.25)	-1.0	0.15 (0.05-0.20)	-1.0
K Gray Cast Iron	Tensile Strength ≤350MPa	Finish	LM	SV	VP15TF	130 (90-170)	0.20 (0.10-0.25)	-1.0	0.15 (0.05-0.20)	-1.0
			MM	-	MC7025	105 (70-135)	0.20 (0.10-0.25)	-2.0	0.20 (0.15-0.25)	-1.0
		Medium	MV	-	US735	125 (85-165)	0.20 (0.10-0.25)	-1.0	0.15 (0.05-0.20)	-1.0
MM	MV		VP15TF	120 (80-160)	0.20 (0.10-0.25)	-2.0	0.20 (0.15-0.25)	-1.0		
N Aluminium Alloy	-	Finish	F	FS	HTi10	300 (200-400)	0.10 (0.05-0.15)	-0.5	0.10 (0.05-0.15)	-0.5
			Flat Top	-	MD220	200 (150-250)	0.10 (0.05-0.15)	-2.0	0.10 (0.05-0.15)	-1.0
H Hardened Steel	35-65HRC	Finish	Flat Top	-	MB8120	100 (80-200)	0.10 (0.05-0.15)	-0.15	0.10 (0.05-0.15)	-0.1

Note 1) When vibrations occur, reduce cutting speed by 30%.

Note 2) The depth of cut needs to be less than the corner diameter when using the FSVJ type.

Note 3) The recommended pressure for the internal coolant is 1MPa.

Note 4) The insert photos are only examples. The letters refer to the chipbreaker and the dimension refers to the inscribed circle.

Note 5) Dimensions shown for insert corner RE 0.4. (Model of ☆ Mark is RE 0.8)

Note 6) When using insert with right and left hand chipbreaker, please use left hand insert for right hand holder and right hand insert for left hand holder.

● : Inventory maintained. ★ : Inventory maintained in Japan.

VB \odot type inserts	> A164-A166
VC \odot type inserts	> A167-A169
PCBN & PCD inserts	> B059, B071

DOUBLE CLAMP

DIMPLE BAR

- Economical negative insert.
- Single action type.
- Excellent vibration resistance due to a light dimple head. (With coolant hole.)
- l/d is 3 to 4 times the diameter.

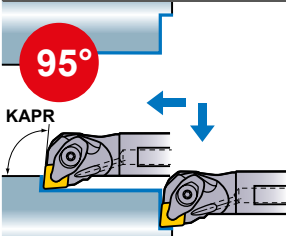
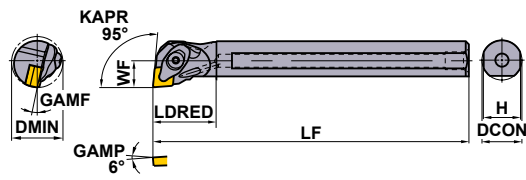
A○○○-DCLN		With coolant hole		CN○○inserts		Finish	Light	Light	Medium										
				Right hand tool holder shown.						FP	SA	LP	LM						
										(12)	(12)	(12)	(12)						
										Medium	Medium	Stainless	PCBN/PCD						
										MP	Standard	MM							
										(12)	(12)	(12)	(12)						
Order Number	Stock		Insert Number	Dimensions (mm)						Tools									
	R	L		DCON	LF	LDRED	WF	H	GAMF	DMIN	Shim	Shim Pin	Clamp Bridge	Spring	Clamp Screw	Wrench			
A25R-DCLNR/L12	●	●	CN○○A CN○○G CN○○M	1204○○	25	200	40	17	23	13°	32	LLSCP42	LLP14	DCK2613	DCS1	DC0621T	TKY20F		
A32S-DCLNR/L12	●	●		1204○○	32	250	50	22	30	13°	40	LLSCN42	LLP14	DCK2613	DCS1	DC0621T	TKY20F		
A40T-DCLNR/L12	●	●		1204○○	40	300	63	27	37	10°	50	LLSCN42	LLP14	DCK2613	DCS1	DC0621T	TKY20F		

* Clamp Torque (N · m) : DC0621T=5.0

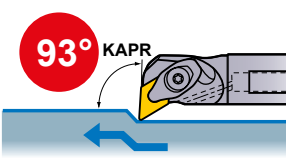
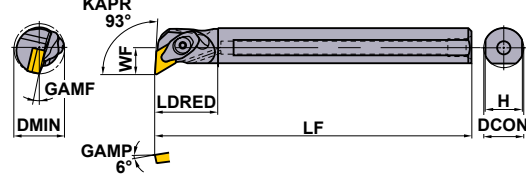
A○○○-DDUN		With coolant hole		DN○○inserts		Finish	Light	Medium	Medium										
				Right hand tool holder shown.						FP	LP	MP	MH						
										(15)	(15)	(15)	(15)						
										Medium	Stainless	G Class	PCBN/PCD						
										Standard	MM	R/L							
										(15)	(15)	(15)	(15)						
Order Number	Stock		Insert Number	Dimensions (mm)						Tools									
	R	L		DCON	LF	LDRED	WF	H	GAMF	DMIN	Shim	Shim Pin	Clamp Bridge	Spring	Clamp Screw	Wrench			
A25R-DDUNR/L15	★	●	DN○○A DN○○G DN○○M	1504○○	25	200	40	17	23	13°	35	LLSDP42	LLP14	DCK2613	DCS1	DC0621T	TKY20F		
A32S-DDUNR/L15	●	●		1504○○	32	250	50	22	30	13°	40	LLSDN42	LLP14	DCK2613	DCS1	DC0621T	TKY20F		
A40T-DDUNR/L15	●	●		1504○○	40	300	63	27	37	10°	50	LLSDN42	LLP14	DCK2613	DCS1	DC0621T	TKY20F		

* Clamp Torque (N · m) : DC0621T=5.0

RECOMMENDED CUTTING CONDITIONS

Work Material	Hardness	Cutting Mode	l/d ≤ 3			l/d = 3-4		
			Cutting Speed (m/min)	Feed (mm/rev)	Depth of Cut (mm)	Cutting Speed (m/min)	Feed (mm/rev)	Depth of Cut (mm)
P Carbon Steel Alloy Steel	180-350HB	Medium	110 (80-140)	0.25 (0.1-0.4)	-5.0	110 (80-140)	0.2 (0.1-0.3)	-4.0
M Stainless Steel	≤200HB	Medium	80 (60-100)	0.2 (0.1-0.3)	-4.0	70 (50-100)	0.15 (0.1-0.25)	-3.0
K Gray Cast Iron	Tensile Strength ≤350MPa	Medium	80 (60-100)	0.25 (0.1-0.4)	-5.0	80 (60-100)	0.2 (0.1-0.3)	-4.0

- CN○○ type inserts > A098-A104
- DN○○ type inserts > A105-A111
- PCBN & PCD inserts > B036-B042, B064







- SPARE PARTS > N001
- TECHNICAL DATA > P001

BORING BARS

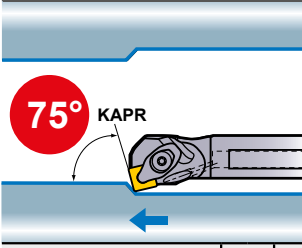
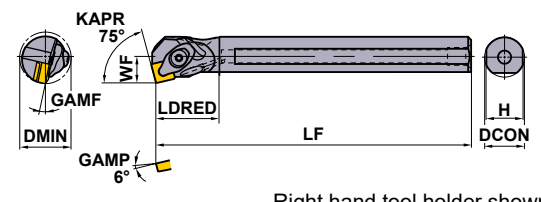
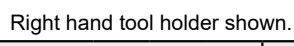
DOUBLE CLAMP







DIMPLE BAR

- Economical negative insert.
- Single action type.
- Good vibration resistance due to the light dimple head. (With coolant hole)
- l/d is 3 to 4 times the diameter.

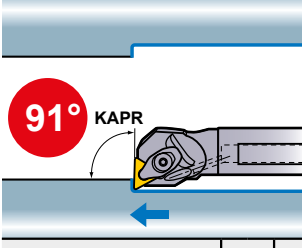
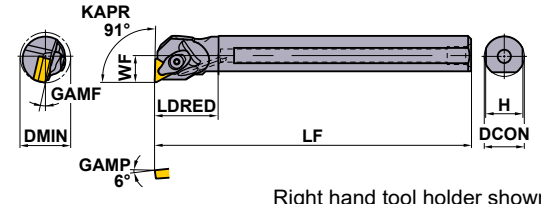
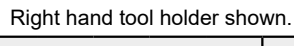
A○○○-DSKN		With coolant hole		SN○○inserts							Finish	Light	Medium	Medium			
				Right hand tool holder shown.							FP (12)	LP (12)	MP (12)	MH (12)			
											Medium Standard	Stainless MM	G Class R/L	PCBN/PCD (12)			
Order Number	Stock		Insert Number	Dimensions (mm)													
	R	L		DCON	LF	LDRED	WF	H	GAMF	DMIN	Shim	Shim Pin	Clamp Bridge	Spring	Clamp Screw	Wrench	
A25R-DSKNR/L12	★	★	SNMA SNMG SNMM SNGA SNGG	1204○○	25	200	40	17	23	13°	32	LLSSP42	LLP14	DCK2613	DCS1	DC0621T	TKY20F
A32S-DSKNR/L12	★	★		1204○○	32	250	50	22	30	13°	40	LLSSN42	LLP14	DCK2613	DCS1	DC0621T	TKY20F

* Clamp Torque (N · m) : DC0621T=5.0

BORING BARS

A○○○-DTFN		With coolant hole		TN○○inserts							Finish	Light	Medium	Medium			
				Right hand tool holder shown.							FP (16)	LP (16)	MP (16)	MH (16)			
											Medium Standard	Stainless MM	G Class R/L	PCBN/PCD (16)			
Order Number	Stock		Insert Number	Dimensions (mm)													
	R	L		DCON	LF	LDRED	WF	H	GAMF	DMIN	Shim	Shim Pin	Clamp Bridge	Spring	Clamp Screw	Wrench	
A25R-DTFNR/L16	●	●	TN○○A TN○○G TN○○M	1604○○	25	200	40	17	23	13°	32	LLSTP32	LLP23	DCK2211	DCS2	DC0520T	TKY15F
A32S-DTFNR/L16	★	★		1604○○	32	250	50	22	30	13°	40	LLSTN32	LLP23	DCK2211	DCS2	DC0520T	TKY15F

* Clamp Torque (N · m) : DC0520T=3.5

Note 1) The insert photos are only examples. The letters refer to the chipbreaker and the dimension refers to the inscribed circle.

Note 2) Dimensions shown for insert corner RE 0.8.

Note 3) When using insert with right and left hand chipbreaker, please use left hand insert for right hand holder and right hand insert for left hand holder.

● : Inventory maintained. ★ : Inventory maintained in Japan.

SN○○ type inserts	> A113–A118
TN○○ type inserts	> A119–A125
PCBN & PCD inserts	> B043–B045, B065

A [○] ○ [○] -DVUN With coolant hole VN [○] ○ inserts										Finish	Light	Medium	Medium			
										FP	LP	MP	MH			
										(16)	(16)	(16)	(16)			
										Medium	Stainless	G Class	PCBN/PCD			
										Standard	MM	R/L				
										(16)	(16)	(16)	(16)			
Order Number	Stock	Insert Number	Dimensions (mm)							Shim	Shim Pin	Clamp Bridge	Spring	Clamp Screw *	Wrench	
			R	L	DCON	LF	LDRED	WF	H							GAMF
A40T-DVUNR/L16	● ★	VN [○] A VN [○] G VN [○] M	1604 [○]	40	300	63	27	37	9°	50	DCSVN32	LLP13	DCK3113	DCS2	DC0520T	TKY15F

* Clamp Torque (N · m) : DC0520T=3.5

A [○] ○ [○] -DWLN With coolant hole WN [○] ○ inserts										Finish	Light	Medium	Medium			
										FP	LP	MP	MK			
										(08)	(06,08)	(06,08)	(08)			
										Medium	Medium-Rough	Stainless				
										Standard	RP	MM				
										(08)	(08)	(06,08)				
Order Number	Stock	Insert Number	Dimensions (mm)							Shim	Shim Pin	Clamp Bridge	Spring	Clamp Screw *	Wrench	
			R	L	DCON	LF	LDRED	WF	H							GAMF
A25R-DWLNR/L06	● ★	WNMA WNMG	0604 [○]	25	200	40	17	23	13°	35	LLSWP32	LLP23	DCK2211	DCS2	DC0520T	TKY15F
A25R-DWLNR/L08	● ●	WNMA	0804 [○]	25	200	40	17	23	13°	35	LLSWP42	LLP14	DCK2613	DCS1	DC0621T	TKY20F
A32S-DWLNR/L08	● ●	WNMA WNMG	0804 [○]	32	250	50	22	30	13°	40	LLSWN42	LLP14	DCK2613	DCS1	DC0621T	TKY20F
A40T-DWLNR/L08	● ●	WNGA	0804 [○]	40	300	63	27	37	10°	50	LLSWN42	LLP14	DCK2613	DCS1	DC0621T	TKY20F

* Clamp Torque (N · m) : DC0520T=3.5, DC0621T=5.0

RECOMMENDED CUTTING CONDITIONS

Work Material	Hardness	Cutting Mode	l/d ≤ 3			l/d = 3-4		
			Cutting Speed (m/min)	Feed (mm/rev)	Depth of Cut (mm)	Cutting Speed (m/min)	Feed (mm/rev)	Depth of Cut (mm)
P Carbon Steel Alloy Steel	180-350HB	Medium	110 (80-140)	0.25 (0.1-0.4)	-5.0	110 (80-140)	0.2 (0.1-0.3)	-4.0
M Stainless Steel	≤200HB	Medium	80 (60-100)	0.2 (0.1-0.3)	-4.0	70 (50-100)	0.15 (0.1-0.25)	-3.0
K Gray Cast Iron	Tensile Strength ≤350MPa	Medium	80 (60-100)	0.25 (0.1-0.4)	-5.0	80 (60-100)	0.2 (0.1-0.3)	-4.0

VN[○]○ type inserts > A126-A129
 WN[○]○ type inserts > A130-A134
 PCBN & PCD inserts > B046-B048, B066

SPARE PARTS > N001
 TECHNICAL DATA > P001

BORING BARS

MICRO-DEX BORING BARS

- The minimum cutting diameter is from $\phi 5$. ● l/d is 5 times the diameter.
- 5°, 7° positive insert, carbide shank type.
- Easy-to-use tool geometries.
- Suitable for small workpieces.

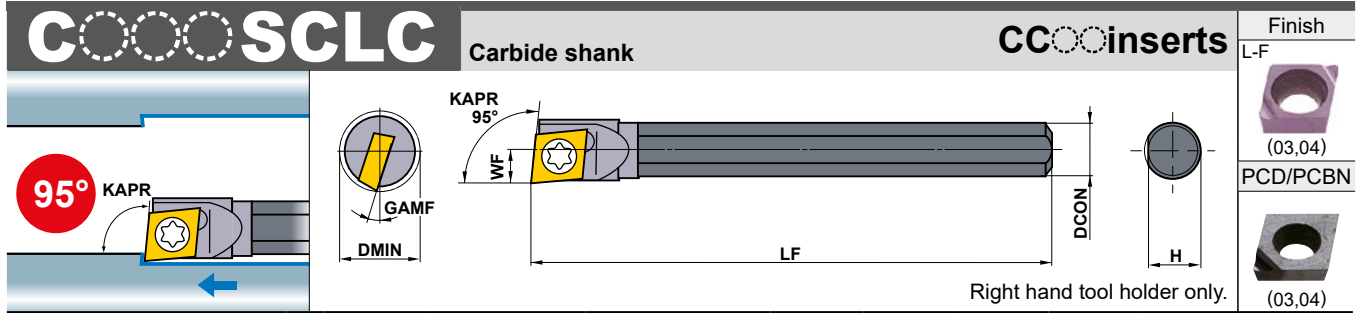

Order Number	Stock R	Insert Number	Dimensions (mm)							*2	
			DCON	LF	WF	H	GAMF	DMIN	Clamp Screw	Wrench	
C04GSCLCR03	●	*1	03S1	4	90	2.5	3.7	15°	5	TS16	TKY06F
C05HSCLCR03	●	CCGT	03S1	5	100	3.0	4.7	13°	6	TS16	TKY06F
C06JSCLCR04	●	CCGW	04T0	6	110	3.5	5.7	13°	7	TS21	TKY08F
C07KSCLCR04	●	CCMW	04T0	7	125	4.0	6.7	11°	8	TS21	TKY08F

*1 Diameter of inscribed circle is special. (For SCLC type)

*2 Clamp Torque (N · m) : TS16=0.6, TS21=0.6

E

BORING BARS

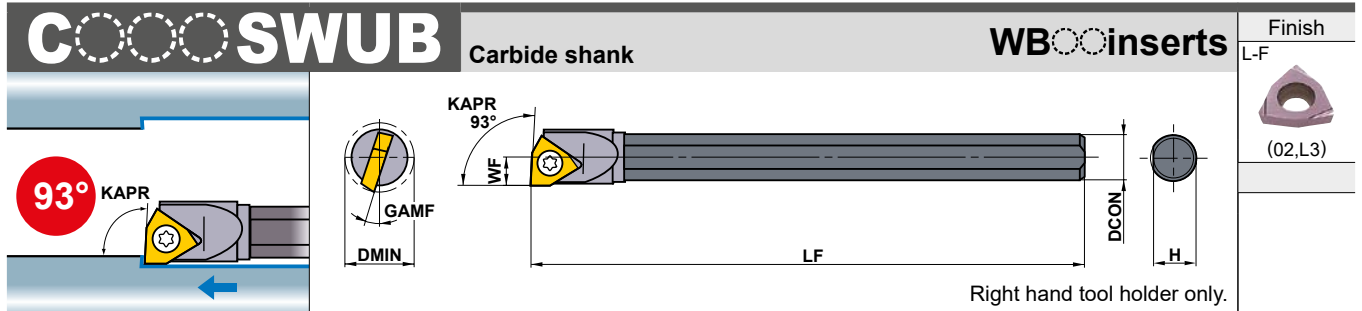

Order Number	Stock R	Insert Number	Dimensions (mm)							*	
			DCON	LF	WF	H	GAMF	DMIN	Clamp Screw	Wrench	
C05HSWUBR02	●	WBGT	0201	5	100	3.0	4.7	15°	6	TS21	TKY06F
C06JSWUBR02	●	WBMT	0201	6	110	3.5	5.7	13°	7	TS2C	TKY06F
C07KSWUBRL3	●	L302	0201	7	125	4.0	6.7	15°	8	TS2	TKY06F

* Clamp Torque (N · m) : TS21=0.6, TS2C=0.6, TS2=0.6

Note 1) The insert photos are only examples. The letters refer to the chipbreaker and the dimension refers to the inscribed circle.





Note 2) Dimensions shown for insert corner RE 0.2.

Note 3) When using insert with right and left hand chipbreaker, please use left hand insert for right hand holder and right hand insert for left hand holder.

● : Inventory maintained.

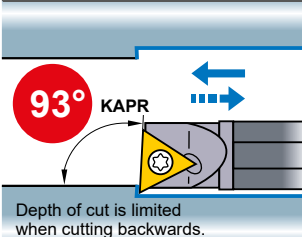
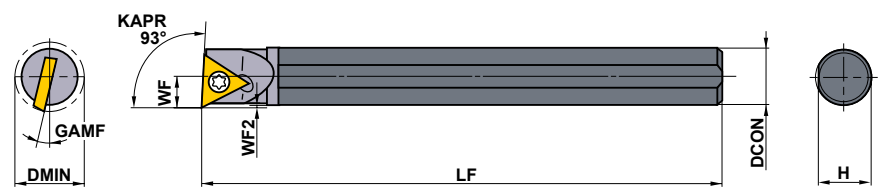
CC type inserts	> A140
WB type inserts	> A172
PCBN & PCD inserts	> B052, B067

MICRO-DEX BORING BARS

COSTUC			Carbide shank	TCGT inserts							Finish		
													 R/L-F (06)
Order Number	Stock	Insert Number	Dimensions (mm)								*		
	R		DCON	LF	WF	WF2	H	GAMF	DMIN	 Clamp Screw	 Wrench		
C07KSTUCR06	●	TCGT 060100L-F	7	125	4.0	0.35	6.7	12°	8	TS2C	TKY06F		

* Clamp Torque (N • m) : TS2C=0.6

RECOMMENDED CUTTING CONDITIONS

	Work Material	Grade	Cutting Speed (m/min)	Feed (mm/rev)	Depth of Cut (mm)	l/d
P	Carbon Steel, Alloy Steel 180–350HB	NX2525	80 (40–120)	0.03 (0.01–0.05)	0.2 (0.1–0.3)	3–5
M	Stainless Steel ≤200HB	VP15TF	80 (40–120)	0.03 (0.01–0.05)	0.2 (0.1–0.3)	3–5
K	Gray Cast Iron ≤350MPa	VP15TF	80 (40–120)	0.03 (0.01–0.05)	0.2 (0.1–0.3)	3–5
N	Non-Ferrous Material	VP15TF	120 (80–160)	0.05 (0.01–0.08)	0.4 (0.1–0.6)	3–5
		MD220	120 (80–160)	0.05 (0.01–0.08)	0.4 (0.1–0.6)	3–5
H	Hardened Steel 35–65HRC	MB8110	80 (40–120)	0.03 (0.01–0.05)	0.1 (0.03–0.2)	3–5

TCGT type inserts > A158
 SPARE PARTS > N001
 TECHNICAL DATA > P001

BORING BARS

MICRO-DEX BORING BARS

STANDARD HOLDER

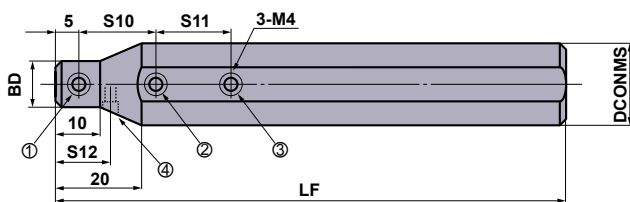
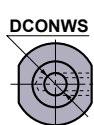

RBH2200N has a temporary set screw for different machine specifications.
(Represented by number 4)

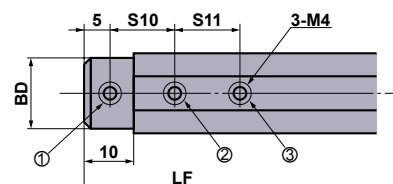

RBH15800N, RBH1600N,
RBH19000N

Order Number	Stock	Dimensions (mm)							MICRO-DEX	*1 Clamp Screw				Wrench	Torque (N·m)
		DCONMS	DCONWS	BD	LF	S10	S11	S12		①	②	③	④		
RBH15840N	★	15.875	4	15	100	15	15	—	C04GS	A	A	A	—	HKY20F	2.0
RBH15850N	★	15.875	5	15	100	15	15	—	C05HS	A	A	A	—	HKY20F	2.0
RBH15860N	★	15.875	6	15	100	15	15	—	C06JS	A	A	A	—	HKY20F	2.0
RBH15870N	★	15.875	7	15	100	20	20	—	C07KS	A	A	A	—	HKY20F	2.0
RBH1640N	●	16	4	15	100	15	15	—	C04GS	A	A	A	—	HKY20F	2.0
RBH1650N	●	16	5	15	100	15	15	—	C05HS	A	A	A	—	HKY20F	2.0
RBH1660N	●	16	6	15	100	15	15	—	C06JS	A	A	A	—	HKY20F	2.0
RBH1670N	●	16	7	15	100	20	20	—	C07KS	A	A	A	—	HKY20F	2.0
*2 RBH19040N	★	19.05	4	18	125	15	15	—	C04GS	B	B	B	—	HKY20F	2.0
*2 RBH19050N	★	19.05	5	18	125	15	15	—	C05HS	B	B	B	—	HKY20F	2.0
*2 RBH19060N	★	19.05	6	18	125	15	15	—	C06JS	B	B	B	—	HKY20F	2.0
*2 RBH19070N	★	19.05	7	18	125	20	20	—	C07KS	B	B	B	—	HKY20F	2.0
RBH2040N	★	20	4	13	125	15	15	—	C04GS	A	B	B	—	HKY20F	2.0
RBH2050N	★	20	5	14	125	15	15	—	C05HS	A	B	B	—	HKY20F	2.0
RBH2060N	★	20	6	15	125	15	15	—	C06JS	A	B	B	—	HKY20F	2.0
RBH2070N	★	20	7	16	125	20	20	—	C07KS	A	B	B	—	HKY20F	2.0
RBH2240N	★	22	4	13	125	15	15	12.5	C04GS	A	B	B	A	HKY20F	2.0
RBH2250N	★	22	5	14	125	15	15	12.5	C05HS	A	B	B	A	HKY20F	2.0
RBH2260N	★	22	6	15	125	15	15	15	C06JS	A	B	B	A	HKY20F	2.0
RBH2270N	★	22	7	16	125	20	20	15	C07KS	A	B	B	A	HKY20F	2.0
RBH2540N	★	25	4	13	150	15	15	—	C04GS	A	C	C	—	HKY20F	2.0
RBH2550N	★	25	5	14	150	15	15	—	C05HS	A	C	C	—	HKY20F	2.0
RBH2560N	★	25	6	15	150	15	15	—	C06JS	A	C	C	—	HKY20F	2.0
RBH2570N	★	25	7	16	150	20	20	—	C07KS	A	C	C	—	HKY20F	2.0
RBH25440N	★	25.4	4	13	150	15	15	—	C04GS	A	C	C	—	HKY20F	2.0
RBH25450N	★	25.4	5	14	150	15	15	—	C05HS	A	C	C	—	HKY20F	2.0
RBH25460N	★	25.4	6	15	150	15	15	—	C06JS	A	C	C	—	HKY20F	2.0
RBH25470N	★	25.4	7	16	150	20	20	—	C07KS	A	C	C	—	HKY20F	2.0

*1 Order number of clamp screw A=HSS04004, B=HSS04006, C=HSS04008

*2 Revised order number.

Conventional Order Number	Revised Order Number
RBH1940N	RBH19040N
RBH1950N	RBH19050N
RBH1960N	RBH19060N
RBH1970N	RBH19070N

● : Inventory maintained. ★ : Inventory maintained in Japan.

MICRO-MINI TWIN

CB

For internal machining

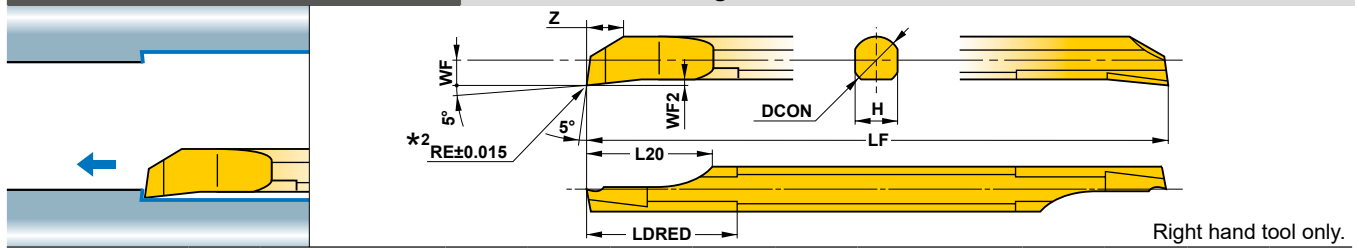

Order Number	Stock		Breaker	Dimensions (mm)										
	Micro Grain	Coated		DMIN *1		RE	DCON	LF	L20	LDRED	WF	WF2	H	Z
	TF15	VP15TF		l/d ≤ 3	l/d > 3									
CB02RS	●	●	without	2.2	3.6	0.05	2	50	5	6	1	0.25	1.8	1.4
CB02RS-B	●	●	with	2.2	3.9	0.05	2	50	5	6	1	0.25	1.8	1.4
CB02RS-01	●	●	without	2.2	3.6	0.1	2	50	5	6	1	0.25	1.8	1.4
CB02RS-01B	●	●	with	2.2	4.2	0.1	2	50	5	6	1	0.25	1.8	1.4
CB02RS-02	●	●	without	2.2	3.6	0.2	2	50	5	6	1	0.25	1.8	1.4
CB02RS-02B	●	●	with	2.2	4.9	0.2	2	50	5	6	1	0.25	1.8	1.4
CB03RS	●	●	without	3.2	4.2	0.05	3	50	7.5	9	1.5	0.35	2.7	2.3
CB03RS-B	●	●	with	3.2	4.4	0.05	3	50	7.5	9	1.5	0.35	2.7	2.3
CB03RS-01	●	●	without	3.2	4.2	0.1	3	50	7.5	9	1.5	0.35	2.7	2.3
CB03RS-01B	●	●	with	3.2	4.5	0.1	3	50	7.5	9	1.5	0.35	2.7	2.3
CB03RS-02	●	●	without	3.2	4.2	0.2	3	50	7.5	9	1.5	0.35	2.7	2.3
CB03RS-02B	●	●	with	3.2	4.8	0.2	3	50	7.5	9	1.5	0.35	2.7	2.3
CB04RS	●	●	without	4.2	5.1	0.05	4	60	10	12	2	0.45	3.6	3.1
CB04RS-B	●	●	with	4.2	5.2	0.05	4	60	10	12	2	0.45	3.6	3.1
CB04RS-01	●	●	without	4.2	5.1	0.1	4	60	10	12	2	0.45	3.6	3.1
CB04RS-01B	●	●	with	4.2	5.3	0.1	4	60	10	12	2	0.45	3.6	3.1
CB04RS-02	●	●	without	4.2	5.1	0.2	4	60	10	12	2	0.45	3.6	3.1
CB04RS-02B	●	●	with	4.2	5.5	0.2	4	60	10	12	2	0.45	3.6	3.1
CB05RS	●	●	without	5.2	6.0	0.05	5	70	12.5	15	2.5	0.55	4.5	3.9
CB05RS-B	●	●	with	5.2	6.1	0.05	5	70	12.5	15	2.5	0.55	4.5	3.9
CB05RS-02	●	●	without	5.2	6.0	0.2	5	70	12.5	15	2.5	0.55	4.5	3.9
CB05RS-02B	●	●	with	5.2	6.4	0.2	5	70	12.5	15	2.5	0.55	4.5	3.9
CB06RS	●	●	without	6.2	7.2	0.05	6	75	12.5	18	3	0.65	5.4	4.7
CB06RS-B	●	●	with	6.2	7.3	0.05	6	75	12.5	18	3	0.65	5.4	4.7
CB06RS-02	●	●	without	6.2	7.2	0.2	6	75	12.5	18	3	0.65	5.4	4.7
CB06RS-02B	●	●	with	6.2	7.8	0.2	6	75	12.5	18	3	0.65	5.4	4.7
CB07RS	●	●	without	7.2	8.6	0.05	7	85	12.5	21	3.5	0.75	6.3	5.5
CB07RS-B	●	●	with	7.2	8.8	0.05	7	85	12.5	21	3.5	0.75	6.3	5.5
CB07RS-02	●	●	without	7.2	8.6	0.2	7	85	12.5	21	3.5	0.75	6.3	5.5
CB07RS-02B	●	●	with	7.2	9.2	0.2	7	85	12.5	21	3.5	0.75	6.3	5.5
CB08RS	●	●	without	8.2	9.5	0.05	8	95	15	24	4	0.85	7.2	6.3
CB08RS-B	●	●	with	8.2	9.6	0.05	8	95	15	24	4	0.85	7.2	6.3
CB08RS-02	●	●	without	8.2	9.5	0.2	8	95	15	24	4	0.85	7.2	6.3
CB08RS-02B	●	●	with	8.2	9.8	0.2	8	95	15	24	4	0.85	7.2	6.3

*1 DMIN : Min. Cutting Diameter

*2 The RE dimension represents the size before grinding a chipbreaker.

RECOMMENDED CUTTING CONDITIONS

Work Material	Micro-Mini Twin CB				Micro-Mini Twin CR		
	Cutting Speed (m/min)	Feed (mm/rev)	Depth of Cut (mm)	l/d	Cutting Speed (m/min)	Feed (mm/rev)	
						03RS/04RS	05RS
P Carbon Steel, Alloy Steel 180-350HB	80 (40-120)	0.03 (0.01-0.05)	0.2 (0.1-0.3)	3-5	80 (40-120)	0.02 (0.01-0.03)	0.03 (0.01-0.05)
M Stainless Steel ≤200HB	80 (40-120)	0.03 (0.01-0.05)	0.2 (0.1-0.3)	3-5	80 (40-120)	0.02 (0.01-0.03)	0.03 (0.01-0.05)
K Gray Cast Iron ≤350MPa	80 (40-120)	0.03 (0.01-0.05)	0.2 (0.1-0.3)	3-5	80 (40-120)	0.03 (0.01-0.05)	0.03 (0.01-0.05)
N Non-Ferrous Material	120 (80-160)	0.05 (0.01-0.08)	0.3 (0.1-0.5)	3-5	120 (80-160)	0.03 (0.01-0.05)	0.05 (0.01-0.08)

Note 1) Wet machining is recommended.

Note 2) The recommended tool overhang of CR type is LU+2mm.

MICRO-MINI TWIN

CR

For internal copying

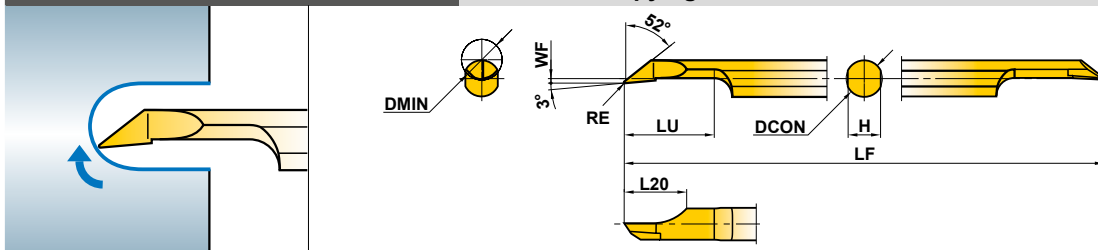

Right hand tool only.

Order Number	Stock		Breaker	Dimensions (mm)							
	Micro Grain	Coated		DMIN	RE	DCON	LF	LU	L20	WF	H
	TF15	VP15TF									
CR03RS-01	●	●	without	3.5	0.1	3	50	8	6	0.15	2.7
CR03RS-01B	●	●	with	3.5	0.1	3	50	8	6	0.15	2.7
CR04RS-01	●	●	without	4.5	0.1	4	60	10	7	0.15	3.6
CR04RS-01B	●	●	with	4.5	0.1	4	60	10	7	0.15	3.6
CR05RS-01	●	●	without	5.5	0.1	5	70	12	8	0.15	4.5
CR05RS-01B	●	●	with	5.5	0.1	5	70	12	8	0.15	4.5

E

BORING BARS

RECOMMENDED CUTTING CONDITIONS

Work Material	Micro-Mini Twin CB				Micro-Mini Twin CR		
	Cutting Speed (m/min)	Feed (mm/rev)	Depth of Cut (mm)	l/d	Cutting Speed (m/min)	Feed (mm/rev)	
						03RS/04RS	05RS
P Carbon Steel, Alloy Steel 180–350HB	80 (40–120)	0.03 (0.01–0.05)	0.2 (0.1–0.3)	3–5	80 (40–120)	0.02 (0.01–0.03)	0.03 (0.01–0.05)
M Stainless Steel ≤200HB	80 (40–120)	0.03 (0.01–0.05)	0.2 (0.1–0.3)	3–5	80 (40–120)	0.02 (0.01–0.03)	0.03 (0.01–0.05)
K Gray Cast Iron ≤350MPa	80 (40–120)	0.03 (0.01–0.05)	0.2 (0.1–0.3)	3–5	80 (40–120)	0.03 (0.01–0.05)	0.03 (0.01–0.05)
N Non-Ferrous Material	120 (80–160)	0.05 (0.01–0.08)	0.3 (0.1–0.5)	3–5	120 (80–160)	0.03 (0.01–0.05)	0.05 (0.01–0.08)

Note 1) Wet machining is recommended.

Note 2) The recommended tool overhang of CR type is LU+2mm.

● : Inventory maintained.

■ PRECAUTIONS WHEN USING THE MICRO-MINI TWIN

● When using a holder for general purpose / small automatic lathe:

- ① To avoid chipping of the 2nd cutting edge take care when inserting the boring bar into the holder. Refer to fig.1. If the 2nd edge contacts the internal face of the holder there is a possibility that it may chip.

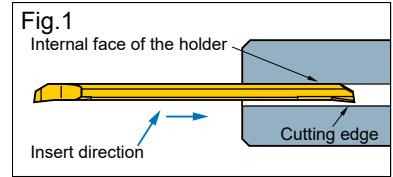

- ② When using this type of holder, there is a possibility that damage to the shank and the 2nd cutting edge can occur. Make sure that the clamping screws are tightened to the set torque value. Additionally make sure that there is no clamping screw near the 2nd cutting edge as this can break the boring bar.

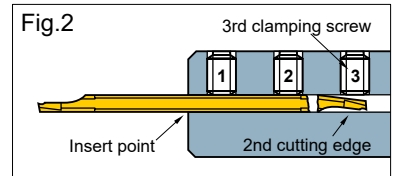

◎ When using Mitsubishi holders

When using holders with a tool overhang of recommended quantity, ensure that the 3rd clamping screw is removed prior to machining. (RBH1620N, RBH19020N, RBH2020N and RBH2520N do not have the 3rd screw.) The set torque value for the clamping screw is 2.0 N·m.

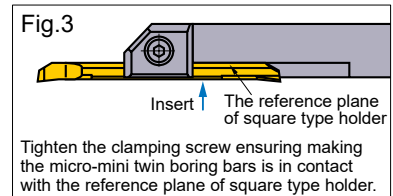

● When using a square type holder:

- ① When installing the boring bar into the holder, tighten the clamp screws after ensuring the flats on the tool holder are parallel to the reference flats on the micro-mini bar. Refer to fig.3.
- ② Make sure that the clamping screws are tightened to the recommended values.
- ③ Do not tighten the clamp screw without a bar in place, otherwise the bridge will be deformed.

MACHINING METHODS OF THE CR TYPE

● Profile turning

By drilling a pre-prepared hole, the machining time will be shortened and chip control will be improved.

<Cutting Conditions>

Workpiece : DIN S20C
 Holder : CR05RS-01B
 Cutting Speed : 80m/min
 Feed : 0.05mm/rev
 Depth of Cut : 0.05mm
 Wet Cutting

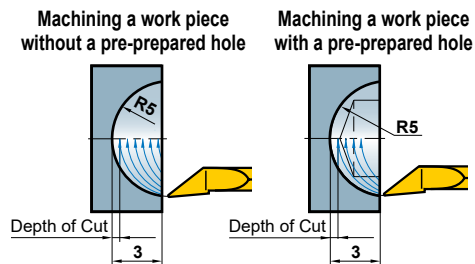

● Inner end facing

By drilling a pre-prepared hole, the machining time will be shortened and chip control will be improved.

<Cutting Conditions>

Workpiece : DIN S20C
 Holder : CR05RS-01B
 Cutting Speed : 80m/min
 Feed : 0.05mm/rev
 Depth of Cut : 0.05mm
 Wet Cutting

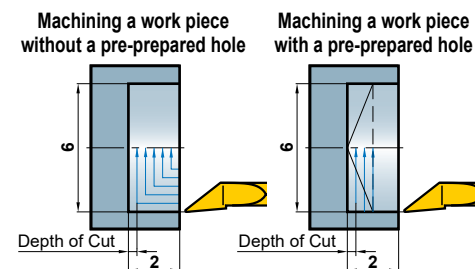

■ NOTES FOR USE

Profile turning, Inner end facing

The cutting edge should not be cross the centre line of the work piece.

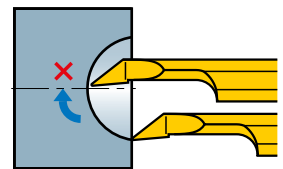

If the cutting edge crosses the centre line of a work piece, the cutting edge can fracture.

Copying

The depth of cut should be smaller than the corner radius value.

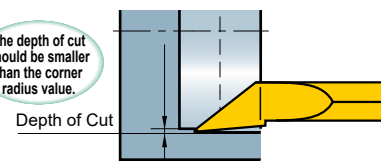

With depths of cut larger than the corner radius value, burrs will be formed.

BORING BARS

MICRO-MINI BORING BARS

- Solid carbide type with minimum cutting diameter $\phi 3.2\text{mm}$.
- l/d is 5 times the diameter.
- Cutting edge can be shaped according to the application thus, it covers a wide cutting range (threading, grooving, copying, etc.).

STANDARD MICRO-MINI BORING BARS (Solid carbide boring bar)

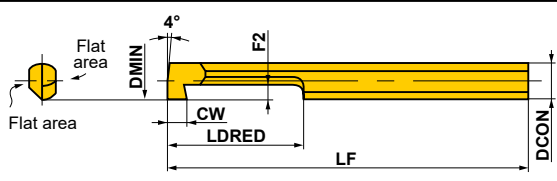
Order Number	Stock TF15	Dimensions (mm)						Geometry
		CW	DCON	LF	LDRED	DMIN	F2	
C03FR-BLS	★	2.0	3	80	15	3.2	1.0	
C04FR-BLS	★	2.5	4	80	20	4.2	1.5	
C05HR-BLS	★	3.0	5	100	25	5.2	2.0	

RECOMMENDED CUTTING CONDITIONS

Work Material	Cutting Speed (m/min)	Feed (mm/rev)	Depth of Cut (mm)	l/d	Edge Condition (mm)	
					*Corner Radius or BCH	*Honing
P Carbon Steel, Alloy Steel 180–350HB	40 (30–50)	0.05 (–0.1)	0.2 (0.1–0.3)	5	0.1–0.5	0.01–0.05
M Stainless Steel ≤200HB	40 (30–50)	0.05 (–0.1)	0.2 (0.1–0.3)	5	≤0.4	≤0.03 (Honing not required)
K Gray Cast Iron ≤350MPa	40 (30–50)	0.05 (–0.05)	0.2 (0.1–0.3)	5	0.1–0.5	0.01–0.05
N Non-Ferrous Material	80 (60–100)	0.05 (–0.1)	0.3 (0.1–0.5)	5	0.1–0.5	≤0.03 (Honing not required)

* Cutting edge is not honed. Please hone according to the workpiece before machining.

GRINDING THE CUTTING EDGE OF MICRO-MINI BORING BAR

- MICRO-MINI boring bar can be applied to boring and grooving without any modifications. It can also be reground as shown below.
- For shaping and regrinding, use a diamond whetstone approximately #250–#400. Please grind according to the application using the figure below as a reference.

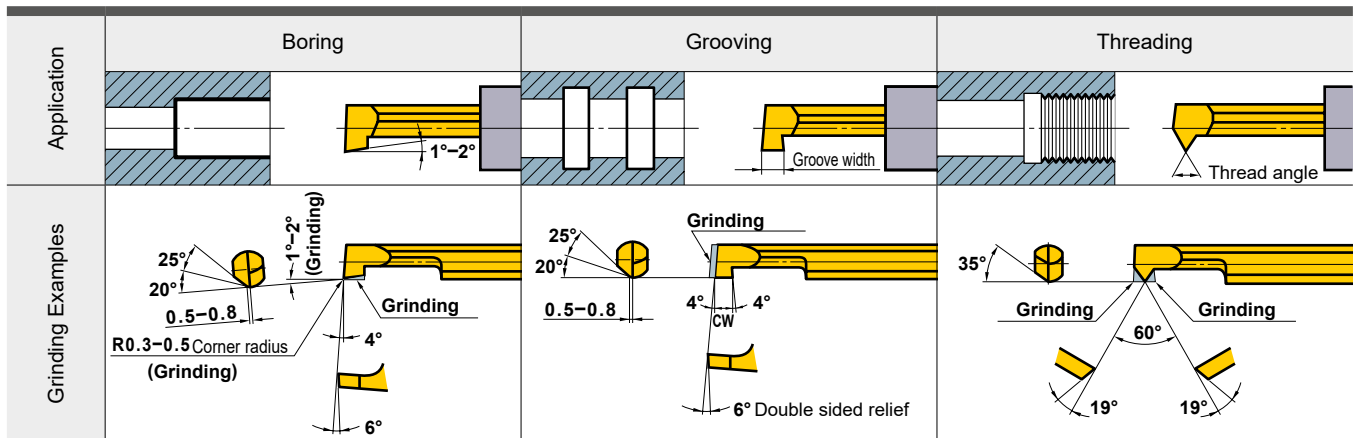

● : Inventory maintained. ★ : Inventory maintained in Japan.

ROUND TYPE HOLDER

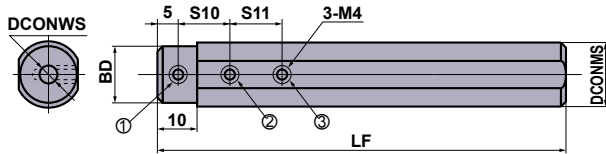

RBH158 \odot N, RBH16 \odot N, RBH190 \odot N

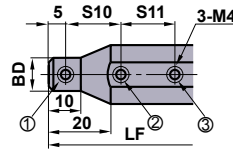

RBH200 \odot N, RBH25 \odot N, RBH254 \odot N

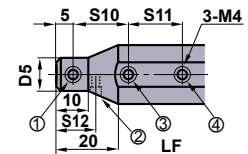

RBH220 \odot N

Order Number	Stock	Dimensions (mm)							Micro-Mini C	Micro-Mini Twin		*1 Clamp Screw				Wrench	Torque (N·m)
		DCONMS	DCONWS	BD	LF	S10	S11	S12		CB	CR	①	②	③	④		
RBH15820N	★	15.875	2	15	100	10	—	—	02RS(-B) 02RS-0(B)	—	B	B	—	—	HKY20F	2.0	
RBH15830N	★	15.875	3	15	100	10	—	03FR-BLS	03RS(-B) 03RS-0(B)	03RS-01(B)	A	A	A	—	HKY20F	2.0	
RBH15840N	★	15.875	4	15	100	15	—	04FR-BLS	04RS(-B) 04RS-0(B)	04RS-01(B)	A	A	A	—	HKY20F	2.0	
RBH15850N	★	15.875	5	15	100	15	—	05HR-BLS	05RS(-B) 05RS-0(B)	05RS-01(B)	A	A	A	—	HKY20F	2.0	
RBH15860N	★	15.875	6	15	100	15	—	—	06RS(-B) 06RS-0(B)	—	A	A	A	—	HKY20F	2.0	
RBH15870N	★	15.875	7	15	100	20	—	—	07RS(-B) 07RS-0(B)	—	A	A	A	—	HKY20F	2.0	
RBH15880N	★	15.875	8	15	100	20	—	—	08RS(-B) 08RS-0(B)	—	D	D	D	—	HKY20F	2.0	
RBH1620N	●	16	2	15	100	10	—	—	02RS(-B) 02RS-0(B)	—	B	B	—	—	HKY20F	2.0	
RBH1630N	●	16	3	15	100	10	—	03FR-BLS	03RS(-B) 03RS-0(B)	03RS-01(B)	A	A	A	—	HKY20F	2.0	
RBH1640N	●	16	4	15	100	15	—	04FR-BLS	04RS(-B) 04RS-0(B)	04RS-01(B)	A	A	A	—	HKY20F	2.0	
RBH1650N	●	16	5	15	100	15	—	05HR-BLS	05RS(-B) 05RS-0(B)	05RS-01(B)	A	A	A	—	HKY20F	2.0	
RBH1660N	●	16	6	15	100	15	—	—	06RS(-B) 06RS-0(B)	—	A	A	A	—	HKY20F	2.0	
RBH1670N	●	16	7	15	100	20	—	—	07RS(-B) 07RS-0(B)	—	A	A	A	—	HKY20F	2.0	
RBH1680N	★	16	8	15	100	20	—	—	08RS(-B) 08RS-0(B)	—	D	D	D	—	HKY20F	2.0	
*2 RBH19020N	★	19.05	2	18	125	10	—	—	02RS(-B) 02RS-0(B)	—	C	C	—	—	HKY20F	2.0	
*2 RBH19030N	★	19.05	3	18	125	10	—	03FR-BLS	03RS(-B) 03RS-0(B)	03RS-01(B)	B	B	B	—	HKY20F	2.0	
*2 RBH19040N	★	19.05	4	18	125	15	—	04FR-BLS	04RS(-B) 04RS-0(B)	04RS-01(B)	B	B	B	—	HKY20F	2.0	
*2 RBH19050N	★	19.05	5	18	125	15	—	05HR-BLS	05RS(-B) 05RS-0(B)	05RS-01(B)	B	B	B	—	HKY20F	2.0	
*2 RBH19060N	★	19.05	6	18	125	15	—	—	06RS(-B) 06RS-0(B)	—	B	B	B	—	HKY20F	2.0	
*2 RBH19070N	★	19.05	7	18	125	20	—	—	07RS(-B) 07RS-0(B)	—	B	B	B	—	HKY20F	2.0	
RBH19080N	★	19.05	8	18	125	20	—	—	08RS(-B) 08RS-0(B)	—	A	A	A	—	HKY20F	2.0	
RBH2020N	★	20	2	11	125	10	—	—	02RS(-B) 02RS-0(B)	—	A	A	—	—	HKY20F	2.0	
RBH2030N	★	20	3	12	125	10	—	03FR-BLS	03RS(-B) 03RS-0(B)	03RS-01(B)	A	A	B	—	HKY20F	2.0	
RBH2040N	★	20	4	13	125	15	—	04FR-BLS	04RS(-B) 04RS-0(B)	04RS-01(B)	A	B	B	—	HKY20F	2.0	
RBH2050N	★	20	5	14	125	15	—	05HR-BLS	05RS(-B) 05RS-0(B)	05RS-01(B)	A	B	B	—	HKY20F	2.0	
RBH2060N	★	20	6	15	125	15	—	—	06RS(-B) 06RS-0(B)	—	A	B	B	—	HKY20F	2.0	
RBH2070N	★	20	7	16	125	20	—	—	07RS(-B) 07RS-0(B)	—	A	B	B	—	HKY20F	2.0	
RBH2080N	★	20	8	17	125	20	—	—	08RS(-B) 08RS-0(B)	—	A	A	A	—	HKY20F	2.0	
RBH2220N	★	22	2	11	125	10	—	—	02RS(-B) 02RS-0(B)	—	A	B	—	A	HKY20F	2.0	
RBH2230N	★	22	3	12	125	10	—	03FR-BLS	03RS(-B) 03RS-0(B)	03RS-01(B)	A	B	C	A	HKY20F	2.0	
RBH2240N	★	22	4	13	125	15	—	04FR-BLS	04RS(-B) 04RS-0(B)	04RS-01(B)	A	B	B	A	HKY20F	2.0	
RBH2250N	★	22	5	14	125	15	—	05HR-BLS	05RS(-B) 05RS-0(B)	05RS-01(B)	A	B	B	A	HKY20F	2.0	
RBH2260N	★	22	6	15	125	15	—	—	06RS(-B) 06RS-0(B)	—	A	B	B	A	HKY20F	2.0	
RBH2270N	★	22	7	16	125	20	—	—	07RS(-B) 07RS-0(B)	—	A	B	B	A	HKY20F	2.0	
RBH2280N	★	22	8	17	125	20	—	—	08RS(-B) 08RS-0(B)	—	A	B	B	A	HKY20F	2.0	
RBH2520N	★	25	2	11	150	10	—	—	02RS(-B) 02RS-0(B)	—	A	B	—	—	HKY20F	2.0	
RBH2530N	★	25	3	12	150	10	—	03FR-BLS	03RS(-B) 03RS-0(B)	03RS-01(B)	A	B	C	—	HKY20F	2.0	
RBH2540N	★	25	4	13	150	15	—	04FR-BLS	04RS(-B) 04RS-0(B)	04RS-01(B)	A	C	C	—	HKY20F	2.0	
RBH2550N	★	25	5	14	150	15	—	05HR-BLS	05RS(-B) 05RS-0(B)	05RS-01(B)	A	C	C	—	HKY20F	2.0	
RBH2560N	★	25	6	15	150	15	—	—	06RS(-B) 06RS-0(B)	—	A	C	C	—	HKY20F	2.0	
RBH2570N	★	25	7	16	150	20	—	—	07RS(-B) 07RS-0(B)	—	A	C	C	—	HKY20F	2.0	
RBH2580N	★	25	8	17	150	20	—	—	08RS(-B) 08RS-0(B)	—	A	B	B	—	HKY20F	2.0	
RBH25420N	★	25.4	2	11	150	10	—	—	02RS(-B) 02RS-0(B)	—	A	B	—	—	HKY20F	2.0	
RBH25430N	★	25.4	3	12	150	10	—	03FR-BLS	03RS(-B) 03RS-0(B)	03RS-01(B)	A	B	C	—	HKY20F	2.0	
RBH25440N	★	25.4	4	13	150	15	—	04FR-BLS	04RS(-B) 04RS-0(B)	04RS-01(B)	A	C	C	—	HKY20F	2.0	
RBH25450N	★	25.4	5	14	150	15	—	05HR-BLS	05RS(-B) 05RS-0(B)	05RS-01(B)	A	C	C	—	HKY20F	2.0	
RBH25460N	★	25.4	6	15	150	15	—	—	06RS(-B) 06RS-0(B)	—	A	C	C	—	HKY20F	2.0	
RBH25470N	★	25.4	7	16	150	20	—	—	07RS(-B) 07RS-0(B)	—	A	C	C	—	HKY20F	2.0	
RBH25480N	★	25.4	8	17	150	20	—	—	08RS(-B) 08RS-0(B)	—	A	B	B	—	HKY20F	2.0	

*1 Order number of clamp screw A=HSS04004, B=HSS04006, C=HSS04008, D=HSS04003 *2 Revised order number.

Conventional Order Number	Revised Order Number	Conventional Order Number	Revised Order Number
RBH1920N	RBH19020N	RBH1950N	RBH19050N
RBH1930N	RBH19030N	RBH1960N	RBH19060N
RBH1940N	RBH19040N	RBH1970N	RBH19070N

SPARE PARTS > N001
TECHNICAL DATA > P001

MICRO-MINI TWIN

■ SQUARE TYPE HOLDER

CB type (Boring bar fits in a holder)

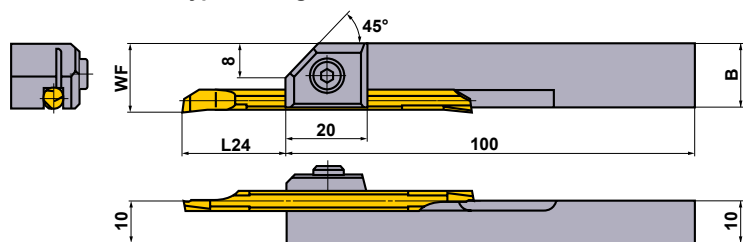

CR type (Boring bar fits in a holder)

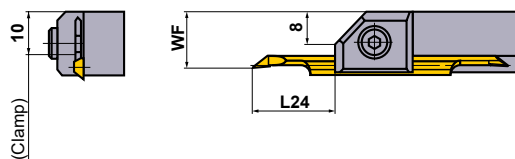

Order Number	Stock	Dimensions (mm)						Micro-Mini Twin		Clamp Screw	Wrench	Torque (N·m)
		WF		L24 *		B		CB	CR			
		CB	CR	CB	CR	CB	CR					
SBH1020R	★	13	—	6—24 (6—10)	—	12.9	02RS(-B) 02RS-0(B)	—	HSC04010	HKY30R	4.8	
SBH1030R	★	14	12.65	8.5—22 (9—15)	11—19.5 (12)	13.8	03RS(-B) 03RS-0(B)	03RS-01(B)	HSC05012	HKY40R	9.5	
SBH1040R	★	15	13.15	11—29.5 (12—20)	13—27.5 (14)	14.7	04RS(-B) 04RS-0(B)	04RS-01(B)	HSC05012	HKY40R	9.5	
SBH1050R	★	16	13.65	13.5—37 (15—25)	15—35.5 (16)	15.6	05RS(-B) 05RS-0(B)	05RS-01(B)	HSC05012	HKY40R	9.5	
SBH1060R	★	17	—	13.5—42 (18—30)	—	16.5	06RS(-B) 06RS-0(B)	—	HSC05012	HKY40R	9.5	
SBH1070R	★	18	—	13.5—52 (21—35)	—	17.4	07RS(-B) 07RS-0(B)	—	HSC05012	HKY40R	9.5	

Note 1) The MICRO-DEX and the MICRO-MINI cannot be fit to square holders.

* L24 is the length of overhang for sufficient clamping, and () is the recommended length for machining of carbon and alloy steel.

F TYPE BORING BARS

- The minimum cutting diameter is from $\phi 10$.
- 11° positive insert.
- Screw-on type.
- l/d is 3 to 5 times the diameter (Carbide shank is 7 times the diameter).

FSTU1		TP \odot inserts								Light	Flat Top	
										R/L		
										(08,09,11)	(08,09,11)	
										PCD	PCD	
										R/L-F		
										(09,11)	(08,09,11)	
Order Number	Stock	Insert Number	Dimensions (mm)							*		
	R		L	DCON	LF	LDRED	WF	H	GAMF			DMIN
FSTU108R/L	●●	TPGX TPMX	0802 \odot	8	125	18	5	7	15°	10	CS200T	TKY06F
FSTU110R/L	●●		0902 \odot	10	150	22	6	9	13°	12	CS250T	TKY08F
FSTU112R/L	●●		0902 \odot	12	180	25	8	11	10°	16	CS250T	TKY08F
FSTU116R/L	●●		1103 \odot	16	200	30	11	14	7°	22	CS300890T	TKY08F

* Clamp Torque (N · m) : CS200T=0.6, CS250T=1.0, CS300890T=1.0

FSTU2		Carbide shank TP \odot inserts								Light	Flat Top	
										R/L		
										(08,09,11)	(08,09,11)	
										PCD	PCD	
										R/L-F		
										(09,11)	(08,09,11)	
Order Number	Stock	Insert Number	Dimensions (mm)							*		
	R		L	DCON	LF	LDRED	WF	H	GAMF			DMIN
FSTU208R/L	●●	TPGX TPMX	0802 \odot	8	125	13	5	7	15°	10	CS200T	TKY06F
FSTU210R/L	●●		0902 \odot	10	150	16	6	9	13°	12	CS250T	TKY08F
FSTU212R/L	●★		0902 \odot	12	180	19	8	11	10°	16	CS250T	TKY08F
FSTU216R/L	●★		1103 \odot	16	200	26	11	14	7°	22	CS300890T	TKY08F

* Clamp Torque (N · m) : CS200T=0.6, CS250T=1.0, CS300890T=1.0

RECOMMENDED CUTTING CONDITIONS

Steel Shank			l/d ≤ 3			l/d = 3-4 (Shank Diameter ≥ 25mm)		
Carbide Shank			l/d ≤ 5			l/d = 6-7		
Work Material	Hardness	Cutting Mode	Cutting Speed (m/min)	Feed (mm/rev)	Depth of Cut (mm)	Cutting Speed (m/min)	Feed (mm/rev)	Depth of Cut (mm)
P Carbon Steel Alloy Steel	180-350HB	Light Cutting	130 (90-160)	0.1 (0.05-0.15)	0.2	120 (80-150)	0.1 (0.05-0.15)	0.2
		Medium Cutting	90 (60-120)	0.25 (0.15-0.35)	-3.0	80 (50-110)	0.15 (0.1-0.2)	-1.5
M Stainless Steel	≤200HB	Light Cutting	140 (100-180)	0.1 (0.05-0.15)	0.2	140 (100-180)	0.1 (0.05-0.15)	0.2
		Medium Cutting	70 (50-90)	0.2 (0.15-0.25)	-2.0	60 (40-80)	0.15 (0.1-0.2)	-1.0
N Aluminium Alloy	-	Light Cutting	300 (200-400)	0.1 (0.05-0.15)	0.2	300 (200-400)	0.1 (0.05-0.15)	0.2
		Medium Cutting	200 (150-250)	0.1 (0.05-0.15)	-2.0	200 (150-250)	0.1 (0.05-0.15)	-1.5

Note 1) The insert photos are only examples. The letters refer to the chipbreaker and the dimension refers to the inscribed circle.

Note 2) Dimensions shown for insert corner RE 0.4.

Note 3) When using insert with right and left hand chipbreaker, please use left hand insert for right hand holder and right hand insert for left hand holder.

TP \odot type inserts	> A162, A163
PCD inserts	> B070
SPARE PARTS	> N001
TECHNICAL DATA	> P001

BORING BARS

F TYPE BORING BARS

- The minimum cutting diameter is from $\phi 22$.
- 11° positive insert.
- Clamp-on type.
- l/d is 3 to 5 times the diameter (Carbide shank is 7 times the diameter).

FCTU1			TP \odot inserts							M Class	M Class	G Class				
			Standard	M Class	G Class	Right hand tool holder shown.										
										 (11,16)	 (11,16)	 (11,16)				
										 (11,16)	 (11,16)					
Order Number	Stock		Insert Number	Dimensions (mm)						Shim	Shim Pin	Clamp Set*	Breaker Piece	Wrench		
	R	L		DCON	LF	LDRED	WF	H	GAMF						DMIN	
FCTU116R/L	●	●	TPMN TPMR TPGN TPGR	1103 \odot	16	200	30	11	14	7°	22	—	—	C3	CBT2N	HKY25R
FCTU120R/L ☆	●	●		1603 \odot	20	200	37	13	18	5°	26	—	—	C4	CBT3F	HKY30R
FCTU125R/L ☆ (4 Side Flat Shank)	●	●		1603 \odot	25	250	40	16	22	5°	32	PT32	BCP202	C4	CBT3F	HKY30R
FCTU132R/L ☆ (4 Side Flat Shank)	●	●		1603 \odot	32	300	45	20	29	0°	40	PT32	BCP201	C4	CBT3F	HKY30R

* Clamp Torque (N · m) : C3=2.2, C4=3.3

E

BORING BARS

FCTU2			Carbide shank	TP \odot inserts							M Class	M Class	G Class			
										 (11,16)	 (11,16)	 (11,16)				
										 (11,16)	 (11,16)					
Order Number	Stock		Insert Number	Dimensions (mm)						Shim	Shim Pin	Clamp Set*	Breaker Piece	Wrench		
	R	L		DCON	LF	LDRED	WF	H	GAMF						DMIN	
FCTU216R	★	●	TPMN TPMR TPGN TPGR	1103 \odot	16	200	26	11	14	7°	22	—	—	C3	CBT2N	HKY25R
FCTU220R ☆	★	●		1603 \odot	20	200	33	13	18	5°	26	—	—	C4	CBT3F	HKY30R
FCTU225R ☆	★	●		1603 \odot	25	250	37	16	22	5°	32	PT32	BCP202	C4	CBT3F	HKY30R

* Clamp Torque (N · m) : C3=2.2, C4=3.3

Note 1) The insert photos are only examples. The letters refer to the chipbreaker and the dimension refers to the inscribed circle.

Note 2) Dimensions shown for insert corner RE 0.4. (Model of ☆ Mark is RE 0.8)

Note 3) When using insert with right and left hand chipbreaker, please use left hand insert for right hand holder and right hand insert for left hand holder.

● : Inventory maintained. ★ : Inventory maintained in Japan.

TP \odot type inserts > A180, A181
PCBN & PCD inserts > B062, B075

F TYPE BORING BARS

- The minimum cutting diameter is from $\phi 5.8$.
- 7° positive insert.
- Screw-on type.
- l/d is 3 to 5 times the diameter (Carbide shank is 7 times the diameter).

FSWL1

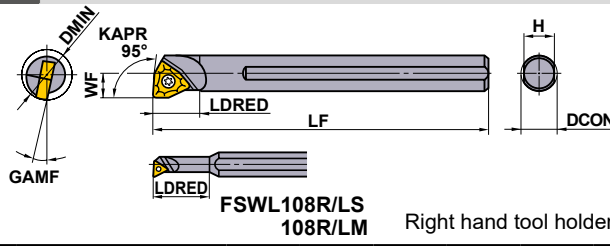
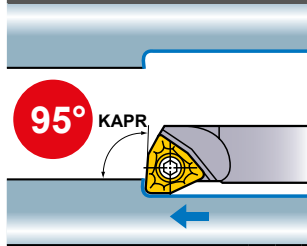

WC \circ inserts

Finish	Light
R/L (02,L3)	Standard (02,L3,04,06)
PCBN/PCD (L3,04,06)	

Order Number	Stock		Insert Number	Dimensions (mm)							* Clamp Screw	 Wrench	
	R	L		DCON	LF	LDRED	WF	H	GAMF	DMIN			
FSWL108R/LS	●	●	WCMT WCGT	0201 \circ	8	100	19	2.9	7	17°	5.8	TS21	TKY06F
FSWL108R/LM	●	●	WCMT WCGT WCMW	L302 \circ	8	100	25	4	7	15°	8	TS2	TKY06F
FSWL108R/L	●	●	WCMT WCMW	0402 \circ	8	125	10	5	7	15°	10	TS25	TKY08F
FSWL110R/L	●	●		0402 \circ	10	150	12	6	9	13°	12	TS25	TKY08F
FSWL112R/L ☆	●	●		06T3 \circ	12	180	15	8	11	13°	16	TS4	TKY15F
FSWL116R/L ☆	●	●		06T3 \circ	16	200	20	11	14	7°	22	TS4	TKY15F

* Clamp Torque (N · m) : TS21=0.6, TS2=0.6, TS25=1.0, TS4=3.5

FSWL2

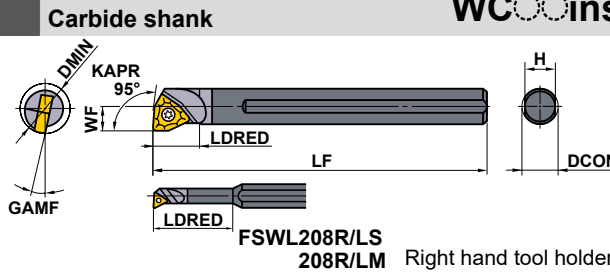
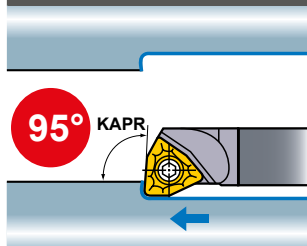

Carbide shank

WC \circ inserts

Finish	Light
R/L (02,L3)	Standard (02,L3,04,06)
PCBN/PCD (L3,04,06)	

Order Number	Stock		Insert Number	Dimensions (mm)							* Clamp Screw	 Wrench	
	R	L		DCON	LF	LDRED	WF	H	GAMF	DMIN			
FSWL208R/LS	●	●	WCMT WCGT	0201 \circ	8	122	25	2.9	7	17°	5.8	TS21	TKY06F
FSWL208R/LM	●	●	WCMT WCGT WCMW	L302 \circ	8	125	33	4	7	15°	8	TS2	TKY06F
FSWL208R/L	●	●	WCMT WCMW	0402 \circ	8	125	10	5	7	15°	10	TS25	TKY08F
FSWL210R/L	●	●		0402 \circ	10	150	12	6	9	13°	12	TS25	TKY08F
FSWL212R/L ☆	●	●		06T3 \circ	12	180	15	8	11	13°	16	TS4	TKY15F
FSWL216R/L ☆	●	●		06T3 \circ	16	200	20	11	14	7°	22	TS4	TKY15F

* Clamp Torque (N · m) : TS21=0.6, TS2=0.6, TS25=1.0, TS4=3.5

RECOMMENDED CUTTING CONDITIONS

Steel Shank			l/d ≤ 3			l/d = 3 - 4 (Shank Diameter ≥ 25mm)		
Carbide Shank			l/d ≤ 5			l/d = 6 - 7		
Work Material	Hardness	Cutting Mode	Cutting Speed (m/min)	Feed (mm/rev)	Depth of Cut (mm)	Cutting Speed (m/min)	Feed (mm/rev)	Depth of Cut (mm)
P Carbon Steel Alloy Steel	180-350HB	Light Cutting	130 (90-160)	0.1 (0.05-0.15)	0.2	120 (80-150)	0.1 (0.05-0.15)	0.2
		Medium Cutting	90 (60-120)	0.25 (0.15-0.35)	-3.0	80 (50-110)	0.15 (0.1-0.2)	-1.5
M Stainless Steel	≤200HB	Light Cutting	140 (100-180)	0.1 (0.05-0.15)	0.2	140 (100-180)	0.1 (0.05-0.15)	0.2
		Medium Cutting	70 (50-90)	0.2 (0.15-0.25)	-2.0	60 (40-80)	0.15 (0.1-0.2)	-1.0
N Aluminium Alloy	-	Light Cutting	300 (200-400)	0.1 (0.05-0.15)	0.2	300 (200-400)	0.1 (0.05-0.15)	0.2
		Medium Cutting	200 (150-250)	0.1 (0.05-0.15)	-2.0	200 (150-250)	0.1 (0.05-0.15)	-1.5

WC \circ type inserts > A173
PCBN & PCD inserts > B060, B072

SPARE PARTS > N001
TECHNICAL DATA > P001

BORING BARS

S TYPE BORING BARS

- The minimum cutting diameter is from $\phi 11$.
- ISO standard.
- 7° positive insert.
- Screw-on type.
- l/d is 3 to 5 times the diameter (Carbide shank is 7 times the diameter).

S		STFC		TC inserts						Finish	Finish	Light	Light
								FP	FM	LP	LM		
								 (09,11,16)	 (09,11,16)	 (09,11,16)	 (09,11,16)		
								Medium	Medium	Flat Top	PCBN/PCD		
								 (09,11,16)	 (09,11,16)	 (11,16)	 (09,11,16)		
Order Number	Stock		Insert Number	Dimensions (mm)						*			
	R	L		DCON	LF	LDRED	WF	H	GAMF	DMIN	Clamp Screw	Wrench	
S08FSTFCR/L09	●	●	TCMT TCGW	0902	8	80	12	6	7	15°	11	TS22	TKY06F
S10HSTFCR/L11	●	●	TCMW TCMT TCGW TCGT	1102	10	100	16	7	9	13°	13	TS25	TKY08F
S12KSTFCR/L11	●	●		1102	12	125	20	9	11	10°	16	TS25	TKY08F
S16MSTFCR/L11	●	●		1102	16	150	25	11	14	7°	20	TS25	TKY08F
S20QSTFCR/L16 ☆	●	●		16T3	20	180	32	13	18	7°	25	TS4	TKY15F
S25RSTFCR/L16 ☆	●	●		16T3	25	200	40	17	23	5°	32	TS4	TKY15F
S32SSTFCR/L16 ☆	●	●		16T3	32	250	50	22	30	5°	40	TS4	TKY15F

* Clamp Torque (N · m) : TS22=0.6, TS25=1.0, TS4=3.5

C		STFC		Carbide shank TC inserts						Finish	Finish	Light	Light
								FP	FM	LP	LM		
								 (09,11,16)	 (09,11,16)	 (09,11,16)	 (09,11,16)		
								Medium	Medium	Flat Top	PCBN/PCD		
								 (09,11,16)	 (09,11,16)	 (11,16)	 (11)		
Order Number	Stock		Insert Number	Dimensions (mm)						*			
	R	L		DCON	LF	LDRED	WF	H	GAMF	DMIN	Clamp Screw	Wrench	
C08HSTFCR09	●	●	TCMT TCGW	0902	8	100	12	6	7	15°	11	TS22	TKY06F
C10KSTFCR11	●	●	TCMW TCMT TCGW TCGT	1102	10	125	16	7	9	13°	13	TS25	TKY08F
C12MSTFCR11	●	●		1102	12	150	20	9	11	10°	16	TS25	TKY08F
C16RSTFCR11	●	●		1102	16	200	25	11	14	7°	20	TS25	TKY08F
C20SSTFCR16 ☆	●	●		16T3	20	250	32	13	18	7°	25	TS4	TKY15F
C25TSTFCR16 ☆	●	●		16T3	25	300	40	17	23	5°	32	TS4	TKY15F

* Clamp Torque (N · m) : TS22=0.6, TS25=1.0, TS4=3.5

Note 1) The insert photos are only examples. The letters refer to the chipbreaker and the dimension refers to the inscribed circle.

Note 2) Dimensions shown for insert corner RE 0.4. (Model of ☆ Mark is RE 0.8)

Note 3) When using insert with right and left hand chipbreaker, please use left hand insert for right hand holder and right hand insert for left hand holder.

● : Inventory maintained.

TC type inserts > A158—A160
PCBN & PCD inserts > B059, B069

SDUC			DC inserts								Finish	Finish	Light	Light
			<p>Right hand tool holder shown.</p>								FP	FM	LP	LM
											(07,11)	(07,11)	(07,11)	(07,11)
											Medium	Medium	Medium	Flat Top
											MP	MM	Standard	
											(07,11,15)	(07,11,15)	(07,11,15)	(07,11,15)
Order Number	Stock		Insert Number	Dimensions (mm)								*		
	R	L		DCON	LF	LDRED	WF	WF2	H	GAMF	DMIN	Clamp Screw	Wrench	
S10HSDUCR/L07	●	●	DCMT DCET DCGT DCMW DCGW	0702	10	100	16	7	2.4	9	13°	13	TS25	TKY08F
S12KSDUCR/L07	●	●		0702	12	125	20	9	3.4	11	10°	16	TS25	TKY08F
S16MSDUCR/L07	●	●		0702	16	150	25	11	3.9	14	7°	20	TS25	TKY08F
S20QSDUCR/L11	☆	●		11T3	20	180	32	13	4.4	18	7°	25	TS4	TKY15F
S25RSDUCR/L15	☆	●		1504	25	200	40	17	6.9	23	5°	32	TS5	TKY25F
S32SSDUCR/L15	☆	●		1504	32	250	50	22	8.4	30	5°	40	TS5	TKY25F
S40TSDUCR/L15	☆	●	1504	40	300	63	27	9.4	37	5°	50	TS5	TKY25F	

* Clamp Torque (N · m) : TS25=1.0, TS4=3.5, TS5=7.5

CSDUC			Carbide Shank DC inserts								Finish	Finish	Light	Light
			<p>Right hand tool holder only.</p>								FP	FM	LP	LM
											(07,11)	(07,11)	(07,11)	(07,11)
											Medium	Medium	Medium	Flat Top
											MP	MM	Standard	
											(07,11,15)	(07,11,15)	(07,11,15)	(07,11,15)
Order Number	Stock		Insert Number	Dimensions (mm)								*		
	R	L		DCON	LF	LDRED	WF	WF2	H	GAMF	DMIN	Clamp Screw	Wrench	
C10KSDUCR07	●		DCMT DCET DCGT DCMW DCGW	0702	10	125	16	7	2.1	9	13°	13	TS25	TKY08F
C12MSDUCR07	●			0702	12	150	20	9	3.1	11	10°	16	TS25	TKY08F
C16RSDUCR07	●			0702	16	200	25	11	3.1	14	7°	20	TS25	TKY08F
C20SSDUCR11	☆	●		11T3	20	250	32	13	3.1	18	7°	25	TS4	TKY15F
C25TSDUCR15	☆	●		1504	25	300	40	17	4.9	23	5°	32	TS5	TKY25F

* Clamp Torque (N · m) : TS25=1.0, TS4=3.5, TS5=7.5

RECOMMENDED CUTTING CONDITIONS

Steel Shank			l/d ≤ 3			l/d = 3–4 (Shank Diameter ≥ 25mm)		
Carbide Shank			l/d ≤ 5			l/d = 6–7		
Work Material	Hardness	Cutting Mode	Cutting Speed (m/min)	Feed (mm/rev)	Depth of Cut (mm)	Cutting Speed (m/min)	Feed (mm/rev)	Depth of Cut (mm)
P Carbon Steel Alloy Steel	180–350HB	Light Cutting	130 (90–160)	0.1 (0.05–0.15)	0.2	120 (80–150)	0.1 (0.05–0.15)	0.2
		Medium Cutting	90 (60–120)	0.25 (0.15–0.35)	–3.0	80 (50–110)	0.15 (0.1–0.2)	–1.5
M Stainless Steel	≤200HB	Light Cutting	140 (100–180)	0.1 (0.05–0.15)	0.2	140 (100–180)	0.1 (0.05–0.15)	0.2
		Medium Cutting	70 (50–90)	0.2 (0.15–0.25)	–2.0	60 (40–80)	0.15 (0.1–0.2)	–1.0
N Aluminium Alloy	—	Light Cutting	300 (200–400)	0.1 (0.05–0.15)	0.2	300 (200–400)	0.1 (0.05–0.15)	0.2
		Medium Cutting	200 (150–250)	0.1 (0.05–0.15)	–2.0	200 (150–250)	0.1 (0.05–0.15)	–1.5

DC type inserts > A147–A152
PCBN & PCD inserts > B055, B055, B068

SPARE PARTS > N001
TECHNICAL DATA > P001

BORING BARS

S TYPE BORING BARS

- The minimum cutting diameter is from $\phi 11$.
- ISO standard.
- 7° positive insert.
- Screw-on type.
- l/d is 3 to 5 times the diameter (Carbide shank is 7 times the diameter).

S		SCLC		CC inserts							Finish	Finish	Light	Light
									FP (06,09)	FM (06,09)	LP (06,09)	LM (06,09)		
		Right hand tool holder shown.							Medium MP (06,09,12)	Medium MM (06,09,12)	Flat Top (06,09,12)	PCBN/PCD (06,09,12)		
Order Number	Stock		Insert Number	Dimensions (mm)							*			
	R	L		DCON	LF	LDRED	WF	H	GAMF	DMIN	Clamp Screw	Wrench		
S08FSCLCR/L06	●	●	0602	8	80	12	6	7	15°	11	TS25	TKY08F		
S10HSCLCR/L06	●	●	CCMB CCMH	10	100	16	7	9	13°	13	TS25	TKY08F		
S12KSCLCR/L06	●	●	CCMT	12	125	20	9	11	10°	16	TS25	TKY08F		
S16MSCLCR/L09	☆	●	CCMW	16	150	25	11	14	7°	20	TS4	TKY15F		
S20QSCLCR/L09	☆	●	CCET	20	180	32	13	18	7°	25	TS4	TKY15F		
S25RSCLCR/L12	☆	●	CCGH CCGT	25	200	40	17	23	5°	32	TS5	TKY25F		
S32SSCLCR/L12	☆	●	CCGW	32	250	50	22	30	5°	40	TS5	TKY25F		
S40TSCLCR/L12	☆	●		40	300	63	27	37	5°	50	TS5	TKY25F		

* Clamp Torque (N · m) : TS25=1.0, TS4=3.5, TS5=7.5

C		SCLC		Carbide shank CC inserts							Finish	Finish	Light	Light
									FP (06,09)	FM (06,09)	LP (06,09)	LM (06,09)		
		Right hand tool holder only.							Medium MP (06,09)	Medium MM (06,09)	Flat Top (06,09)	PCBN/PCD (06,09)		
Order Number	Stock		Insert Number	Dimensions (mm)							*			
	R	L		DCON	LF	LDRED	WF	H	GAMF	DMIN	Clamp Screw	Wrench		
C08HSCLCR06	●	●	CCMB CCMH	8	100	12	6	7	15°	11	TS25	TKY08F		
C10KSCLCR06	●	●	CCMT	10	125	16	7	9	13°	13	TS25	TKY08F		
C12MSCLCR06	●	●	CCMW	12	150	20	9	11	10°	16	TS25	TKY08F		
C16RSCLCR09	☆	●	CCET	16	200	25	11	14	7°	20	TS4	TKY15F		
C20SSCLCR09	☆	●	CCGH CCGT CCGW	20	250	32	13	18	7°	25	TS4	TKY15F		

* Clamp Torque (N · m) : TS25=1.0, TS4=3.5

Note 1) The insert photos are only examples. The letters refer to the chipbreaker and the dimension refers to the inscribed circle.

Note 2) Dimensions shown for insert corner RE 0.4. (Model of ☆ Mark is RE 0.8)

Note 3) When using insert with right and left hand chipbreaker, please use left hand insert for right hand holder and right hand insert for left hand holder.

● : Inventory maintained. ☆ : Inventory maintained in Japan.

CC type inserts > A139–A145
PCBN & PCD inserts > B051–B052, B067

S ₀ 00SDQC			DC ₀ inserts								Finish	Finish	Light	Light
											FP	FM	LP	LM
											(07,11)	(07,11)	(07,11)	(07,11)
											Medium	Medium	Flat Top	PCBN/PCD
											MP	MM		
			Right hand tool holder shown.								(07,11,15)	(07,11,15)	(07,11,15)	(07,11)
Order Number	Stock		Insert Number	Dimensions (mm)								*		
	R	L		DCON	LF	LDRED	WF	WF2	H	GAMF	DMIN	Clamp Screw	Wrench	
S10HSDQCR/L07	●	●	DCMT DCET DCGT DCMW DCGW	0702 ₀₀	10	100	16	7	2.4	9	13°	13	TS25	TKY08F
S12KSDQCR/L07	●	●		0702 ₀₀	12	125	20	9	3.4	11	10°	16	TS25	TKY08F
S16MSDQCR/L07	●	●		0702 ₀₀	16	150	25	11	3.9	14	7°	20	TS25	TKY08F
S20QSDQCR/L11	☆	●		11T3 ₀₀	20	180	32	13	4.4	18	7°	25	TS4	TKY15F
S25RSDQCR/L15	☆	●		1504 ₀₀	25	200	40	17	6.9	23	5°	32	TS5	TKY25F
S32SSDQCR15	☆	●		1504 ₀₀	32	250	50	22	8.4	30	5°	40	TS5	TKY25F
S40TSDQCR15	☆	●		1504 ₀₀	40	300	63	27	9.4	37	5°	50	TS5	TKY25F

* Clamp Torque (N • m) : TS25=1.0, TS4=3.5, TS5=7.5

C ₀ 00SDQC			Carbide Shank DC ₀ inserts								Finish	Finish	Light	Light
											FP	FM	LP	LM
											(07,11)	(07,11)	(07,11)	(07,11)
											Medium	Medium	Flat Top	PCBN/PCD
											MP	MM		
			Right hand tool holder only.								(07,11,15)	(07,11,15)	(07,11,15)	(07,11)
Order Number	Stock		Insert Number	Dimensions (mm)								*		
	R			DCON	LF	LDRED	WF	WF2	H	GAMF	DMIN	Clamp Screw	Wrench	
C10KSDQCR07	●		DCMT DCET DCGT DCMW DCGW	0702 ₀₀	10	125	16	7	2.1	9	13°	13	TS25	TKY08F
C12MSDQCR07	●			0702 ₀₀	12	150	20	9	3.1	11	10°	16	TS25	TKY08F
C16RSDQCR07	●			0702 ₀₀	16	200	25	11	3.1	14	7°	20	TS25	TKY08F
C20SSDQCR11	☆	●		11T3 ₀₀	20	250	32	13	3.1	18	7°	25	TS4	TKY15F
C25TSDQCR15	☆	★		1504 ₀₀	25	300	40	17	4.9	23	5°	32	TS5	TKY25F

* Clamp Torque (N • m) : TS25=1.0, TS4=3.5, TS5=7.5

RECOMMENDED CUTTING CONDITIONS

Steel Shank			l/d ≤ 3			l/d = 3 - 4 (Shank Diameter ≥ 25mm)		
Carbide Shank			l/d ≤ 5			l/d = 6 - 7		
Work Material	Hardness	Cutting Mode	Cutting Speed (m/min)	Feed (mm/rev)	Depth of Cut (mm)	Cutting Speed (m/min)	Feed (mm/rev)	Depth of Cut (mm)
P Carbon Steel Alloy Steel	180-350HB	Light Cutting	130 (90-160)	0.1 (0.05-0.15)	0.2	120 (80-150)	0.1 (0.05-0.15)	0.2
		Medium Cutting	90 (60-120)	0.25 (0.15-0.35)	-3.0	80 (50-110)	0.15 (0.1-0.2)	-1.5
M Stainless Steel	≤200HB	Light Cutting	140 (100-180)	0.1 (0.05-0.15)	0.2	140 (100-180)	0.1 (0.05-0.15)	0.2
		Medium Cutting	70 (50-90)	0.2 (0.15-0.25)	-2.0	60 (40-80)	0.15 (0.1-0.2)	-1.0
N Aluminium Alloy	-	Light Cutting	300 (200-400)	0.1 (0.05-0.15)	0.2	300 (200-400)	0.1 (0.05-0.15)	0.2
		Medium Cutting	200 (150-250)	0.1 (0.05-0.15)	-2.0	200 (150-250)	0.1 (0.05-0.15)	-1.5

DC₀ type inserts > A147 - A152
PCBN & PCD inserts > B054, B055, B068

SPARE PARTS > N001
TECHNICAL DATA > P001

BORING BARS

S TYPE BORING BARS

- The minimum cutting diameter is from $\phi 20$.
- ISO standard.
- 7° positive insert.
- Screw-on type.
- l/d is 3 to 5 times the diameter (Carbide shank is 7 times the diameter).

S			VC Inserts									Finish	Finish	Light	Light
Order Number	Stock		Insert Number	Dimensions (mm)								FP	FM	LP	LM
	R	L		DCON	LF	LDRED	WF	WF2	H	GAMF	DMIN	(11,16)	(11,16)	(11,16)	(11,16)
S16MSVQCR/L11	●	●	VCMW VCMT VCGW VCGT	1103	16	150	25	11	3.9	14	7°	20	TS25	TKY08F	
S20QSVQCR/L11	●	●		1103	20	180	32	13	4.4	18	7°	25	TS25	TKY08F	
S25RSVQCR/L16	☆	●		1604	25	200	40	17	6.9	23	5°	32	TS4	TKY15F	
S32SSVQCR/L16	☆	●		1604	32	250	50	22	8.4	30	5°	40	TS4	TKY15F	
S40TSVQCR/L16	☆	●		1604	40	300	63	27	9.4	37	5°	50	TS4	TKY15F	

* Clamp Torque (N · m) : TS25=1.0, TS4=3.5

C			Carbide shank VC Inserts									Finish	Finish	Light	Light
Order Number	Stock		Insert Number	Dimensions (mm)								FP	FM	LP	LM
	R	L		DCON	LF	LDRED	WF	WF2	H	GAMF	DMIN	(11,16)	(11,16)	(11,16)	(11,16)
C16RSVQCR11	●	●	VCMW VCMT VCGW VCGT	1103	16	200	25	11	3.1	14	7°	20	TS25	TKY08F	
C20SSVQCR11	☆	●		1103	20	250	32	13	3.1	18	7°	25	TS25	TKY08F	
C25TSVQCR16	☆	☆		1604	25	300	40	17	4.9	23	5°	32	TS4	TKY15F	

* Clamp Torque (N · m) : TS25=1.0, TS4=3.5

Note 1) The insert photos are only examples. The letters refer to the chipbreaker and the dimension refers to the inscribed circle.

Note 2) Dimensions shown for insert corner RE 0.4. (Model of ☆ Mark is RE 0.8)

Note 3) When using insert with right and left hand chipbreaker, please use left hand insert for right hand holder and right hand insert for left hand holder.

E

BORING BARS

● : Inventory maintained. ☆ : Inventory maintained in Japan.

VC type inserts > A167-A169
PCBN & PCD inserts > B060, B071

S [○] SSKC			SC [○] inserts								Finish	Finish	Light	Light
											FP	FM	LP	LM
											(09)	(09)	(09)	(09)
											Medium	Medium	Medium	Flat Top
											MP	MM	Standard	(09,12)
Order Number	Stock		Insert Number		Dimensions (mm)						*			
	R	L			DCON	LF	LDRED	WF	H	GAMF	DMIN	Clamp Screw	Wrench	
S16MSSKCR/L09 [☆]	●	●	SCMW SCMT	09T3 [○]	16	150	25	11	14	7°	20	TS4	TKY15F	
S20QSSKCR/L09 [☆]	●	●		09T3 [○]	20	180	32	13	18	7°	25	TS4	TKY15F	
S25RSSKCR/L12 [☆]	★	★		1204 [○]	25	200	40	17	23	5°	32	TS5	TKY25F	

* Clamp Torque (N · m) : TS4=3.5, TS5=7.5

S [○] SVUC			VC [○] inserts								Finish	Finish	Light	Light
											FP	FM	LP	LM
											(11,16)	(11,16)	(11,16)	(11,16)
											Medium	Medium	Medium	Flat Top
											MP	MM	Standard	(16)
Order Number	Stock		Insert Number		Dimensions (mm)						*			
	R	L			DCON	LF	LDRED	WF	WF2	H	GAMF	DMIN	Clamp Screw	Wrench
S20QSVUCR/L11	●	●	VCMW VCMT VCGW VCGT	1103 [○]	20	180	32	13	4.4	18	7°	25	TS25	TKY08F
S25RSVUCR/L16 [☆]	●	●		1604 [○]	25	200	40	17	6.9	23	5°	32	TS4	TKY15F
S32SSVUCR/L16 [☆]	●	●		1604 [○]	32	250	50	22	8.4	30	5°	40	TS4	TKY15F
S40TSVUCR/L16 [☆]	●	●		1604 [○]	40	300	63	27	9.4	37	5°	50	TS4	TKY15F

* Clamp Torque (N · m) : TS25=1.0, TS4=3.5

RECOMMENDED CUTTING CONDITIONS

Steel Shank			l/d ≤ 3			l/d = 3–4 (Shank Diameter ≥ 25mm)		
Carbide Shank			l/d ≤ 5			l/d = 6–7		
Work Material	Hardness	Cutting Mode	Cutting Speed (m/min)	Feed (mm/rev)	Depth of Cut (mm)	Cutting Speed (m/min)	Feed (mm/rev)	Depth of Cut (mm)
P Carbon Steel Alloy Steel	180–350HB	Light Cutting	130 (90–160)	0.1 (0.05–0.15)	0.2	120 (80–150)	0.1 (0.05–0.15)	0.2
		Medium Cutting	90 (60–120)	0.25 (0.15–0.35)	–3.0	80 (50–110)	0.15 (0.1–0.2)	–1.5
M Stainless Steel	≤200HB	Light Cutting	140 (100–180)	0.1 (0.05–0.15)	0.2	140 (100–180)	0.1 (0.05–0.15)	0.2
		Medium Cutting	70 (50–90)	0.2 (0.15–0.25)	–2.0	60 (40–80)	0.15 (0.1–0.2)	–1.0
N Aluminium Alloy	—	Light Cutting	300 (200–400)	0.1 (0.05–0.15)	0.2	300 (200–400)	0.1 (0.05–0.15)	0.2
		Medium Cutting	200 (150–250)	0.1 (0.05–0.15)	–2.0	200 (150–250)	0.1 (0.05–0.15)	–1.5

SC[○] type inserts > A155, A156
VC[○] type inserts > A167–A169
PCBN & PCD inserts > B060, B071

SPARE PARTS > N001
TECHNICAL DATA > P001

BORING BARS

S TYPE BORING BARS

- The minimum cutting diameter is from $\phi 20$.
- ISO standard.
- 7° positive insert.
- Screw-on type.

S		SCZC		CC inserts								Finish		Finish		Light		Light	
				FP	FM	LP	LM	Medium	Medium	Flat Top	PCBN/PCD	MP	MM	(06,09)	(06,09)	(06,09)	(06,09)		
				Right hand tool holder shown.															
				Order Number		Stock		Insert Number		Dimensions (mm)						*			
		R L				DCON	OAL	LF	WF	WF2	H	GAMF	DMIN	Clamp Screw		Wrench			
S16MSCZCR/L06		● ●		CC B CC H CC T CC W		0602	16	161	150	11	3	14	10°	20	TS25		TKY08F		
S20QSCZCR/L09		● ●				09T3	20	198	180	13	3	18	7°	25	TS4		TKY15F		

Note 1) The insert photos are only examples. The letters refer to the chipbreaker and the dimension refers to the inscribed circle.

Note 2) When using inserts with right or left hand chipbreakers, please use right hand inserts for right hand holders and left hand inserts for left hand holders.

* Clamp Torque (N · m) : TS25=1.0, TS4=3.5

E

BORING BARS

RECOMMENDED CUTTING CONDITIONS

Work Material	Hardness	Cutting Mode	l/d ≤ 3			l/d = 3 - 4 (Shank Diameter ≥ 25mm)		
			Cutting Speed (m/min)	Feed (mm/rev)	Depth of Cut (mm)	Cutting Speed (m/min)	Feed (mm/rev)	Depth of Cut (mm)
P Carbon Steel Alloy Steel	180-350HB	Light Cutting	130 (90-160)	0.1 (0.05-0.15)	0.2	120 (80-150)	0.1 (0.05-0.15)	0.2
		Medium Cutting	90 (60-120)	0.25 (0.15-0.35)	-3.0	80 (50-110)	0.15 (0.1-0.2)	-1.5
M Stainless Steel	≤200HB	Light Cutting	140 (100-180)	0.1 (0.05-0.15)	0.2	140 (100-180)	0.1 (0.05-0.15)	0.2
		Medium Cutting	70 (50-90)	0.2 (0.15-0.25)	-2.0	60 (40-80)	0.15 (0.1-0.2)	-1.0
N Aluminium Alloy	-	Light Cutting	300 (200-400)	0.1 (0.05-0.15)	0.2	300 (200-400)	0.1 (0.05-0.15)	0.2
		Medium Cutting	200 (150-250)	0.1 (0.05-0.15)	-2.0	200 (150-250)	0.1 (0.05-0.15)	-1.5

● : Inventory maintained. ★ : Inventory maintained in Japan.



CC type inserts > A139-A145
PCBN & PCD inserts > B051, B052, B067

P TYPE BORING BARS

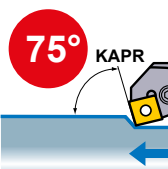
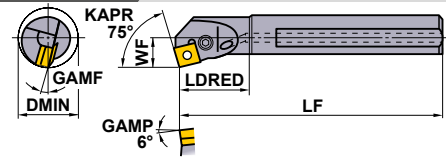
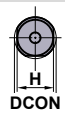
- The minimum cutting diameter is from $\phi 25$. ● l/d is 3 times the diameter.
- ISO standard.
- Economical negative insert.
- Lever lock type and pin lock type.

A $\circ\circ\circ$ PSKN		With coolant hole		SN $\circ\circ$ inserts		Finish	Light	Medium	Medium										
						FP (12)	LP (12)	MP (12)	MH (12)										
						Medium Standard (09,12)	Stainless MM (12)	G Class R/L (09,12)	PCBN/PCD (12)										
Order Number	Stock		Insert Number	Dimensions (mm)								Tools							
	R	L		D CON	LF	LDRED	WF	H	GAMF	DMIN	Shim	Shim Pin	Clamp Lever	Clamp Screw	Wrench	Plug	Clamp Pin	Pin	Screw
A20QPSKNR/L09	●	★	SNMA 0903 $\circ\circ$	20	180	32	13	18	13°	25	—	—	—	—	HKY15R HKY25R	HGM-PT1/8 HGM-PT1/4	HP3T	P208AM	HSS03005
A25RPSKNR/L12	●	●	SNMG 1204 $\circ\circ$	25	200	40	17	23	13°	32	MLSP42	—	—	—	HKY15R HKY30R	HGM-PT1/4 HGM-PT3/8	HP43	P210AM	HSS03005
A32SPSKNR/L12	●	●	SNGA 1204 $\circ\circ$ SNGG	32	250	50	22	30	13°	44	LLSN42	LLP14	LLCL14	LLCS108S	HKY30R	—	—	—	—

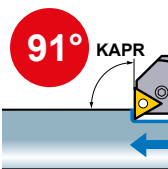
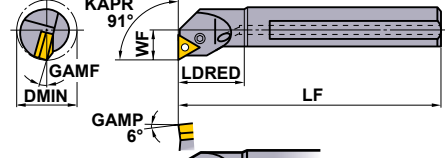
*1 Pin Lock Type : A20QPSKNR/L09, A25RPSKNR/L12
 *2 Clamp Torque (N · m) : LLCS108S=3.3, HP3T=2.2, HP43=3.3

A $\circ\circ\circ$ PTFN		With coolant hole		TN $\circ\circ$ inserts		Finish	Light	Medium	Medium										
						FP (16)	LP (16,22)	MP (16,22)	MH (16,22)										
						Medium Standard (16,22)	Stainless MM (16,22)	G Class R/L (16,22)	PCBN/PCD (16,22)										
Order Number	Stock		Insert Number	Dimensions (mm)								Tools							
	R	L		D CON	LF	LDRED	WF	H	GAMF	DMIN	Shim	Shim Pin	Clamp Lever	Clamp Screw	Wrench	Plug	Clamp Pin	Pin	Screw
A20QPTFNR/L16	●	●	TNMA 1604 $\circ\circ$	20	180	32	13	18	15°	25	—	—	—	—	HKY15R HKY25R	HGM-PT1/8 HGM-PT1/4	HP31	P208AM	HSS03005
A25RPTFNR/L16	●	●	TNMG 1604 $\circ\circ$	25	200	40	17	23	13°	32	MLTP32	—	—	—	HKY15R HKY25R	HGM-PT1/4 HGM-PT3/8	HP33	P208AM	HSS03005
A32SPTFNR/L16	●	●	TNMM 1604 $\circ\circ$ TNGA	32	250	50	22	30	13°	44	LLSTN32	LLP13	LLCL13	LLCS106	HKY25R	—	—	—	—
A40TPTFNR/L22	●	●	TNGG 2204 $\circ\circ$	40	300	63	27	37	10°	54	LLSTN42	LLP14	LLCL14	LLCS108S	HKY30R	HGM-PT3/8	—	—	—
A50UPTFNR/L22	●	●	TNGH 2204 $\circ\circ$	50	350	80	35	47	9°	70	LLSTN42	LLP14	LLCL14	LLCS108S	HKY30R	HGM-PT3/8	—	—	—

*1 Pin Lock Type : A20QPTFNR/L16, A25RPTFNR/L16
 *2 Clamp Torque (N · m) : LLCS106=2.2, LLCS108S=3.3, HP31=2.2, HP33=2.2

RECOMMENDED CUTTING CONDITIONS

Work Material	Hardness	Cutting Mode	l/d ≤ 3			l/d = 3 - 4		
			Cutting Speed (m/min)	Feed (mm/rev)	Depth of Cut (mm)	Cutting Speed (m/min)	Feed (mm/rev)	Depth of Cut (mm)
P Carbon Steel Alloy Steel	180—350HB	Medium Cutting	110 (80—140)	0.25 (0.1—0.4)	—5.0	110 (80—140)	0.2 (0.1—0.3)	—4.0
M Stainless Steel	≤200HB	Medium Cutting	80 (60—100)	0.2 (0.1—0.3)	—4.0	70 (50—100)	0.15 (0.1—0.25)	—3.0
K Gray Cast Iron	Tensile Strength ≤350MPa	Medium Cutting	80 (60—100)	0.25 (0.1—0.4)	—5.0	80 (60—100)	0.2 (0.1—0.3)	—4.0

Note 1) The insert photos are only examples. The letters refer to the chipbreaker and the dimension refers to the inscribed circle.

Note 2) Dimensions shown for insert corner RE 0.4.

Note 3) When using insert with right and left hand chipbreaker, please use left hand insert for right hand holder and right hand insert for left hand holder.

SN $\circ\circ$ type inserts	> A113—A118
TN $\circ\circ$ type inserts	> A119—A125
PCBN & PCD inserts	> B043—B045, B065

SPARE PARTS	> N001
TECHNICAL DATA	> P001

BORING BARS

P TYPE BORING BARS

- The minimum cutting diameter is from $\phi 20$.
- ISO standard.
- Economical negative insert.
- Lever lock type and pin lock type.

A		P		DUN		With coolant hole DN inserts																						
R		L				Right hand tool holder shown.																						
Order Number	Stock		Insert Number	Dimensions (mm)									Shim		Clamp Lever		Clamp Screw		Wrench		Plug		Clamp Pin		Pin		Screw	
	R	L		DCON	LF	LDRED	WF	WF2	H	GAMF	DMIN	Shim	Shim Pin	Clamp Lever	Clamp Screw	Wrench	Plug	Clamp Pin	Pin	Screw								
A20QPUNR/L11	●	●	1104	20	180	32	15	6.4	18	13°	26	—	—	LLCL23S	LLCS125	HKY20R	HGM-PT1/8	—	—	—	—	—	—	—	—	—	—	—
A25RPUNR/L11	●	●	DNMA	1104	25	200	40	17	6.9	23	15°	32	LLSDN32	LLP13	LLCL23	LLCS106	HKY25R	HGM-PT1/4	—	—	—	—	—	—	—	—	—	—
A25RPUNR/L15	●	●	DNMG	1504	25	200	40	17	6.9	23	13°	32	MLDP42	—	—	—	HKY15R HKY30R	HGM-PT1/4	HP43	P210AM	HSS03005	—	—	—	—	—	—	—
A32SPUNR/L11	●	●	DNMX	1104	32	250	50	22	8.4	30	13°	44	LLSDN32	LLP13	LLCL23	LLCS106	HKY25R	HGM-PT3/8	—	—	—	—	—	—	—	—	—	—
A32SPUNR/L15	●	●	DNMM	1504	32	250	50	22	8.4	30	13°	44	LLSDN42	LLP14	LLCL24	LLCS108S	HKY30R	HGM-PT3/8	—	—	—	—	—	—	—	—	—	—
A40TPUNR/L15	●	●	DNGA	1504	40	300	63	27	9.4	37	10°	54	LLSDN42	LLP14	LLCL24	LLCS108S	HKY30R	HGM-PT3/8	—	—	—	—	—	—	—	—	—	—
A50UPUNR/L15	●	●	DNGG	1504	50	350	80	35	12.4	47	9°	70	LLSDN42	LLP14	LLCL24	LLCS108S	HKY30R	HGM-PT3/8	—	—	—	—	—	—	—	—	—	—

*1 Pin Lock Type : A25RPUNR/L15

*2 Clamp Torque (N · m) : LLCS125=1.5, LLCS106=2.2, LLCS108S=3.3, HP43=3.3

A		P		CLN		With coolant hole CN inserts																						
R		L				Right hand tool holder shown.																						
Order Number	Stock		Insert Number	Dimensions (mm)									Shim		Clamp Lever		Clamp Screw		Wrench		Plug		Clamp Pin		Pin		Screw	
	R	L		DCON	LF	LDRED	WF	H	GAMF	DMIN	Shim	Shim Pin	Clamp Lever	Clamp Screw	Wrench	Plug	Clamp Pin	Pin	Screw									
A16MPCLNR/L09	●	●	09T3	16	150	25	11	14	15°	20	—	—	LLCL13S	LLCS105	HKY20R	HGM-PT1/8	—	—	—	—	—	—	—	—	—	—	—	
A20QPCLNR/L09	●	●	09T3	20	180	32	13	18	13°	25	—	—	—	—	—	—	—	—	—	—	—	—	—	—	—	—	—	
A20QPCLNR/L09N	●	★	CNMA	09T3	20	180	32	13	18	13°	25	—	—	LLCL13S	LLCS105	HKY20R	HGM-PT1/8	—	—	—	—	—	—	—	—	—	—	
A25RPCLNR/L09	●	★	CNMG	09T3	25	200	40	17	23	13°	32	—	—	LLCL13S	LLCS105	HKY20R	HGM-PT1/4	—	—	—	—	—	—	—	—	—	—	
A25RPCLNR/L12	●	●	CNMM	09T3	25	200	40	17	23	13°	32	MLCP42	—	—	—	HKY30R HKY15R	HGM-PT1/4	HP43	P210AM	HSS03005	—	—	—	—	—	—	—	
A32SPCLNR/L12	●	●	CNGA	1204	32	250	50	22	30	13°	44	LLSCN42	LLP14	LLCL14	LLCS108S	HKY30R	HGM-PT3/8	—	—	—	—	—	—	—	—	—	—	
A40TPCLNR/L12	●	●	CNGG	1204	40	300	63	27	37	10°	54	LLSCN42	LLP14	LLCL14	LLCS108S	HKY30R	HGM-PT3/8	—	—	—	—	—	—	—	—	—	—	
A50UPCLNR12	●	●	CNGM	1204	50	350	80	35	47	10°	63	LLSCP42	LLP14	LLCL14	LLCS108S	HKY30R	HGM-PT3/8	—	—	—	—	—	—	—	—	—	—	

*1 Pin Lock Type : A20QPCLNR/L09, A25RPCLNR/L12

*2 Clamp Torque (N · m) : LLCS105=1.5, LLCS106=2.2, LLCS108S=3.3, HP3T=2.2, HP43=3.3

*3 When replacing clamp Lever LLCL13S, please consider purchasing lever spring HLS2 as necessary.

Note 1) The insert photos are only examples. The letters refer to the chipbreaker and the dimension refers to the inscribed circle.

Note 2) Dimensions shown for insert corner RE 0.4.

Note 3) When using insert with right and left hand chipbreaker, please use left hand insert for right hand holder and right hand insert for left hand holder.

E

BORING BARS

● : Inventory maintained. ★ : Inventory maintained in Japan.

DN type inserts	> A105—A111
CN type inserts	> A098—A104, A136
PCBN & PCD inserts	> B036—B042, B064

A○○○PWLN		With coolant hole		WN○○inserts							Light	Medium			
				Right hand tool holder shown.											
Order Number	Stock		Insert Number	Dimensions (mm)							*2		*1		
	R	L		DCON	LF	LDRED	WF	H	GAMF	DMIN	Clamp Lever	Clamp Screw	Wrench	Plug	
A16MPWLNR/L06	●	●	WNMG	06T3○○	16	150	25	11	14	15°	20	LLCL13S	LLCS105	HKY20R	HGM-PT1/8
A20QPWLNR/L06	●	●		06T3○○	20	180	32	13	18	13°	25	LLCL13S	LLCS105	HKY20R	HGM-PT1/8
A25RPWLNR/L06	●	●		06T3○○	25	200	40	17	23	13°	32	LLCL13S	LLCS105	HKY20R	HGM-PT1/4

*1 Clamp Torque (N · m) : LLCS105=1.5

*2 When replacing clamp Lever LLCL13S, please consider purchasing lever spring HLS2 as necessary.

A○○○PDQN		With coolant hole		DN○○inserts							Finish	Light	Medium	Medium						
				Right hand tool holder shown.																
Order Number	Stock		Insert Number	Dimensions (mm)							*2		*2							
	R	L		DCON	LF	LDRED	WF	WF2	H	GAMF	DMIN	Shim	Shim Pin	Clamp Lever	Clamp Screw	Wrench	Plug	Clamp Pin	Pin	Screw
A25RPDQNR/L15	●	●	DNMA 1504○○	25	200	40	17	6.9	23	13°	32	MLDP42	—	—	—	HKY15R HKY30R	HGM-PT1/4	HP43	P210AM	HSS03005
A32SPDQNR/L15	●	●	DNMG 1504○○	32	250	50	22	8.4	30	13°	44	LLSDN42	LLP14	LLCL24	LLCS108S	HKY30R	HGM-PT3/8	—	—	—
A40TPDQNR/L15	●	●	DNGA 1504○○	40	300	63	27	9.4	37	10°	54	LLSDN42	LLP14	LLCL24	LLCS108S	HKY30R	HGM-PT3/8	—	—	—
A50UPDQNR/L15	★	●	DNGM 1504○○	50	350	80	35	12.4	47	9°	70	LLSDN42	LLP14	LLCL24	LLCS108S	HKY30R	HGM-PT3/8	—	—	—

*1 Pin Lock Type : A25RPDQNR/L15

*2 Clamp Torque (N · m) : LLCS108S=3.3, HP43=3.3

RECOMMENDED CUTTING CONDITIONS

Work Material	Hardness	Cutting Mode	l/d ≤ 3			l/d = 3 - 4		
			Cutting Speed (m/min)	Feed (mm/rev)	Depth of Cut (mm)	Cutting Speed (m/min)	Feed (mm/rev)	Depth of Cut (mm)
P Carbon Steel Alloy Steel	180—350HB	Medium Cutting	110 (80—140)	0.25 (0.1—0.4)	—5.0	110 (80—140)	0.2 (0.1—0.3)	—4.0
M Stainless Steel	≤200HB	Medium Cutting	80 (60—100)	0.2 (0.1—0.3)	—4.0	70 (50—100)	0.15 (0.1—0.25)	—3.0
K Gray Cast Iron	Tensile Strength ≤350MPa	Medium Cutting	80 (60—100)	0.25 (0.1—0.4)	—5.0	80 (60—100)	0.2 (0.1—0.3)	—4.0

WN○○ type inserts > A130—A133
 DN○○ type inserts > A105—A111
 PCBN & PCD inserts > B039—B042, B064

SPARE PARTS > N001
 TECHNICAL DATA > P001

BORING BARS

P TYPE BORING BARS

- The minimum cutting diameter is from $\phi 32$.
- ISO standard.
- Economical negative insert.
- Lever lock type and pin lock type.

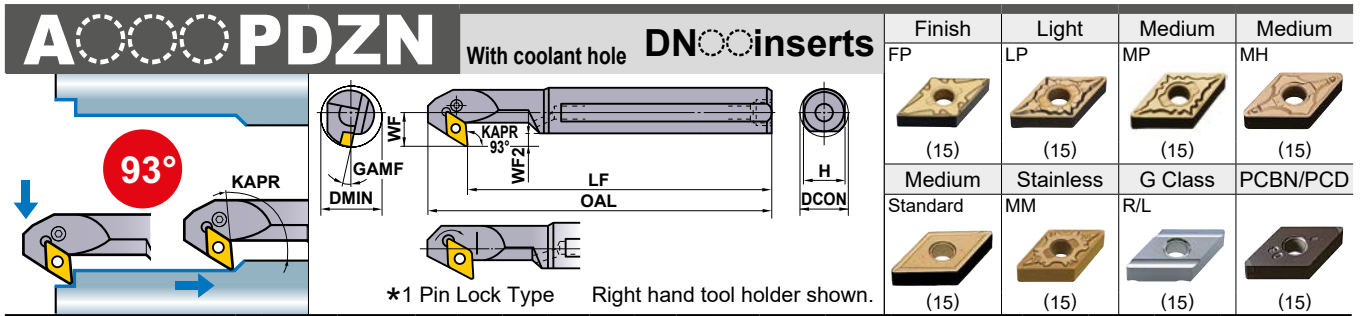

Order Number	Stock		Insert Number	Dimensions (mm)										Accessories										
	R	L		DCON	OAL	LF	WF	WF2	H	GAMF	DMIN	Shim	Shim Pin	Clamp Lever	Clamp Screw	Wrench	Plug	Clamp Pin	Pin	Screw				
A25RPDZNR/L15	●	●	DNMA DNMG	1504	25	225	200	17	6.7	23	13°	32	MLDP42	—	—	—	HKY15R HKY30R	HGM-PT1/4	HP43	P210AM	HSS03005			
A32SPDZNR/L15	●	●	DNMX DNMM	1504	32	275	250	22	8.2	30	13°	40	LLSDN42	LLP14	LLCL24	LLCS108S	HKY30R	HGM-PT3/8	—	—	—			
A40TPDZNR/L15	●	●	DNGA DNGG	1504	40	325	300	27	9.2	37	10°	50	LLSDN42	LLP14	LLCL24	LLCS108S	HKY30R	HGM-PT3/8	—	—	—			
A50UPDZNR/L15	●	●	DNGG DNGM	1504	50	375	350	35	12.2	47	9°	63	LLSDN42	LLP14	LLCL24	LLCS108S	HKY30R	HGM-PT3/8	—	—	—			

*1 Pin Lock Type

*2 Clamp Torque (N · m) : LLCS108S=3.3, HP43=3.3

Note 1) The insert photos are only examples. The letters refer to the chipbreaker and the dimension refers to the inscribed circle.

Note 2) Dimensions shown for insert corner RE 0.8.

Note 3) When using inserts with right or left hand chipbreakers, please use right hand inserts for right hand holders and left hand inserts for left hand holders.

BORING BARS

RECOMMENDED CUTTING CONDITIONS

Work Material	Hardness	Cutting Mode	l/d ≤ 3			l/d = 3 - 4		
			Cutting Speed (m/min)	Feed (mm/rev)	Depth of Cut (mm)	Cutting Speed (m/min)	Feed (mm/rev)	Depth of Cut (mm)
P Carbon Steel Alloy Steel	180—350HB	Medium Cutting	110 (80—140)	0.25 (0.1—0.4)	—5.0	110 (80—140)	0.2 (0.1—0.3)	—4.0
M Stainless Steel	≤200HB	Medium Cutting	80 (60—100)	0.2 (0.1—0.3)	—4.0	70 (50—100)	0.15 (0.1—0.25)	—3.0
K Gray Cast Iron	Tensile Strength ≤350MPa	Medium Cutting	80 (60—100)	0.25 (0.1—0.4)	—5.0	80 (60—100)	0.2 (0.1—0.3)	—4.0

● : Inventory maintained. ★ : Inventory maintained in Japan.

DN type inserts

➤ A105—A111

PCBN & PCD inserts



➤ B039—B042, B064

AL TYPE BORING BARS

- Suitable for non-ferrous metal.
- 20° positive insert.
- Screw-on type.
- l/d is 6 times the diameter.
- Excellent vibration resistance.
- The minimum cutting diameter is from $\phi 20$.



SSTFE

TE inserts

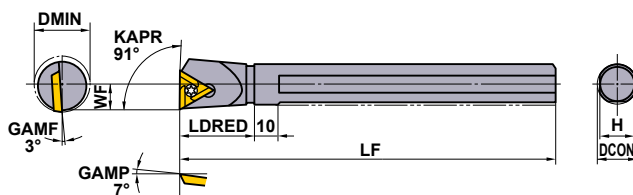
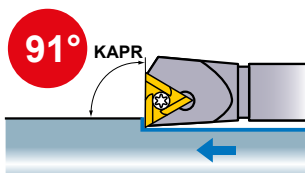
Medium	PCD
R/L  (16)	R/L  (16)
PCD  (16)	



Right hand tool holder shown.

Order Number	Stock		Insert Number	Dimensions (mm)						*  		
	R	L		DCON	LF	LDRED	WF	H	DMIN	Clamp Screw	Wrench	
S16RSTFER/L16	★	★	TEGX	1603	16	200	30	11	14.6	20	FC400890T	TKY10F
S20RSTFER/L16	★	★		1603	20	200	37	13	18	25	FC400890T	TKY10F
S25SSTFER/L16	★	★		1603	25	250	40	17	23	32	FC400890T	TKY10F

* Clamp Torque (N · m) : FC400890T=2.5

Note 1) The insert photos are only examples. The letters refer to the chipbreaker and the dimension refers to the inscribed circle.

Note 2) Dimensions shown for insert corner RE 0.4.

Note 3) When using insert with right and left hand chipbreaker, please use left hand insert for right hand holder and right hand insert for left hand holder.

E

BORING BARS

RECOMMENDED CUTTING CONDITIONS

Work Material	Grade	Cutting Speed (m/min)	l/d=3		l/d=4		l/d=5		l/d=6	
			Feed (mm/rev)	Depth of Cut (mm)	Feed (mm/rev)	Depth of Cut (mm)	Feed (mm/rev)	Depth of Cut (mm)	Feed (mm/rev)	Depth of Cut (mm)
N Aluminium Alloy	HTi10	400 (200-600)	0.15 (0.05-0.25)	-3.0	0.15 (0.05-0.25)	-3.0	0.1 (0.05-0.2)	-2.5	0.1 (0.05-0.2)	-1.0
	MD220	800 (200-1500)	0.15 (0.05-0.25)	-3.0	0.15 (0.05-0.25)	-3.0	0.1 (0.05-0.2)	-2.5	0.1 (0.05-0.2)	-1.0

- TE type inserts > A161
- PCD inserts > B073
- SPARE PARTS > N001
- TECHNICAL DATA > P001

Memo

A series of horizontal dashed lines for writing, spanning the width of the page.

Memo

A series of horizontal dashed lines for writing, spanning the width of the page.

HOW TO READ THE STANDARD OF GROOVING AND CUTTING OFF

●How this section page is organised

- ① Classified according to external or internal applications.
- ② Sub-classified according to product series.
(Refer to the index on the next page.)

FIGURE SHOWING THE TOOLING APPLICATION
Uses illustrations and arrows to depict available machining applications such as cutting off, grooving, and copying.

INDICATION OF HOLDER TYPE ACCORDING TO APPLICATION
Indicates the holder types, such as the 00° type or the 90° type, according to machining application.

TITLE OF PRODUCT

GEOMETRY

PRODUCT SECTION

INDICATION OF EXTERNAL/FACE/INTERNAL APPLICATION

SPARE PARTS FOR HOLDER

GROOVING / CUTTING OFF

GY SERIES (EXTERNAL)

1 00° type holder

Note 1) For modular blades and modular holders, please order separately.
Note 2) Please use right hand modular blade for right hand holder and left hand modular blade for left hand holder.

Seat Size	Dimensions (mm)				Type	Holder	Modular Blade	Stock	Fig.	Dimensions (mm)								Cutting Mode
	CW	CDX	CUTDIA							H	B	LF	LH	LH2	HF	WF	HBH	
D 2.00 2.24	6	12	Modular	R	GYHR1616J00-M20R	GYM20RA-D06	3	16	16	104	28	44	16	20	4	R	Anticlockwise	
				L	GYHL1616J00-M20L	GYM20LA-D06	3	16	16	104	28	44	16	20	4			
			Mono Block	R	GYR2020K00-D06	—	7	20	20	125	36	—	20	20	15			—
				L	GYL2020K00-D06	—	7	20	20	125	36	—	20	20	15			—
			Modular	R	GYHR2020K00-M25R	GYM25RA-D06	1	20	20	119	28	43	20	23	—			—
				L	GYHL2020K00-M25L	GYM25LA-D06	1	20	20	119	28	43	20	23	—			—
		Mono Block	R	GYR2525M00-D06	—	3	20	20	117	31	32	20	26	5	—			
			L	GYL2525M00-D06	—	3	20	20	117	31	32	20	26	5	—			
		10	20	Modular	R	GYHR2225M00-M25R	GYM25RA-D06	1	25	25	142	31	49	25	28			—
					L	GYHL2225M00-M25L	GYM25LA-D06	1	25	25	142	31	49	25	28			—
				Modular	R	GYHR3225P00-M25L	GYM25LA-D06	5	32	25	162	31	49	32	28			—
					L	GYHL3225P00-M25L	GYM25LA-D06	5	32	25	162	31	49	32	28			—
	Mono Block			R	GYR3225P00-D06	—	5	32	32	162	31	49	32	35	—			
				L	GYL3225P00-D06	—	5	32	32	162	31	49	32	35	—			
	18 *4	36	Modular	R	GYHR1616J00-M20R	GYM20RA-D10	3	16	16	110	34	50	16	20	4	L	Clockwise	
				L	GYHL1616J00-M20L	GYM20LA-D10	3	16	16	110	34	50	16	20	4			
			Mono Block	R	GYR2020K00-D18	—	7	20	20	125	36	—	20	20	15			—
				L	GYL2020K00-D18	—	7	20	20	125	36	—	20	20	15			—
			Modular	R	GYHR2020K00-M20R	GYM20RA-D12	1	20	20	125	39	60	20	26	5			—
				L	GYHL2020K00-M20L	GYM20LA-D12	1	20	20	125	39	60	20	26	5			—
			Modular	R	GYHR2525M00-M25R	GYM25RA-D12	3	25	25	150	39	57	25	28	—			—
				L	GYHL2525M00-M25L	GYM25LA-D12	3	25	25	150	39	57	25	28	—			—
			Modular	R	GYHR3225P00-M25R	GYM25RA-D12	5	32	25	170	39	57	32	28	—			—
				L	GYHL3225P00-M25L	GYM25LA-D12	5	32	25	170	39	57	32	28	—			—
Mono Block			R	GYR3225P00-D06	—	5	32	32	170	39	57	32	35	—	—			
			L	GYL3225P00-D06	—	5	32	32	170	39	57	32	35	—	—			
20 *1	40 *2	Modular	R	GYHR1616J00-M20R	GYM20RA-D18	4	16	16	116	40	56	16	20	4	R	Anticlockwise		
			L	GYHL1616J00-M20L	GYM20LA-D18	4	16	16	116	40	56	16	20	4				
		Mono Block	R	GYR2020K00-D18	—	7	20	20	125	36	—	20	20	15			—	
			L	GYL2020K00-D18	—	7	20	20	125	36	—	20	20	15			—	
		Modular	R	GYHR2020K00-M20R	GYM20RA-D20	4	20	20	131	45	66	20	26	5			—	
			L	GYHL2020K00-M20L	GYM20LA-D20	4	20	20	131	45	66	20	26	5			—	
Mono Block	R	GYR2525M00-D20	—	7	25	25	150	41	—	25	25	1	—					
	L	GYL2525M00-D20	—	7	25	25	150	41	—	25	25	1	—					
Modular	R	GYHR2525M00-M25R	GYM25RA-D20	2	25	25	156	45	63	25	28	—	—					
	L	GYHL2525M00-M25L	GYM25LA-D20	2	25	25	156	45	63	25	28	—	—					
	R	GYHR3225P00-M25R	GYM25RA-D20	6	32	25	176	45	63	32	28	—	—					
	L	GYHL3225P00-M25L	GYM25LA-D20	6	32	25	176	45	63	32	28	—	—					

SPARE PARTS

Holder	Clamp Screw	Blade Screw	Wrench
GYHR000000000000	HSC00620 (Clamp Torque : 7.5N.m)	—	HKY40R
GYHR000000000000	GY6013M (Clamp Torque : 6.5N.m)	TS407 (Clamp Torque : 3.5N.m)	TKY30R TKY15D
GYHR000000000000	—	TS55 (Clamp Torque : 5.5N.m)	TKY30R TKY25D

Insert selection

Geometry name:

For grooving/cutting off breaker: F012, F013

For multifunctional grooving breaker: F014, F015

Standard insert with dimensions

LEGEND FOR STOCK STATUS MARK
Is shown on the left hand page of each double-page spread.

PRODUCT STANDARDS
Indicates order numbers, stock status (per right/left hand), holders, modular blades, groove widths, maximum groove depths, maximum cut-off diameters, dimensions, and applicable inserts.

PAGE REFERENCE
- CAUTION FOR USE
- CUTTING CONDITIONS
- IDENTIFICATION
Indicates reference pages, on the right hand page of each double-page spread.

TURNING TOOLS

GROOVING AND CUTTING OFF

CLASSIFICATION (EXTERNAL).....	F002
CLASSIFICATION (INTERNAL).....	F003

STANDARD OF GROOVING AND CUTTING OFF TOOLS

EXTERNAL	
FEATURES OF THE GY SERIES	F004
GY SERIES ORDER NUMBER.....	F008
GY SERIES INSERTS	F012
GY SERIES REFERENCE MATERIAL	F016
GY SERIES.....	F018
GW SERIES.....	F114
MG HOLDER	F124
INTERNAL	
GY SERIES.....	F082
MICRO-MINI BORING BARS	F126
MICRO-MINI TWIN BORING BARS	F127



*Arranged by Alphabetical order

- F126 C^oOR-BLS
- F127 CG
- F120 GW1
- F118 GWB
- F119 GWTB
- F012 GY
- F124 MGH
- F125 MGT
- F129 RBH
- F130 SBH







CLASSIFICATION

EXTERNAL CUTTING

Name of Tool Holder	Insert Shape	Features	Groove Width According to Cutting Mode (mm)					
			Shallow Grooving	Deep Grooving	Cutting Off	Copying	Recessing	Face Grooving
GY Series   F018		Modular blade type ● Clamp-on type. ● The modular blade allows for high rigidity and accuracy. (Triforce System) ● Various insert types. Monoblock type ● Spring clamp type. ● Maximum cut off diameter 50mm.	1.5	1.5	1.5	2	2	2
			2	2	2			
			2.24	2.24	2.24	2.5	2.5	2.5
			2.39	2.39	2.39			
			2.5	2.5	2.5	3	3	3
			2.74	2.74	2.74			
			3	3	3	3.18	3.18	3.18
			3.18	3.18	3.18			
			3.24	3.24	3.24	4	4	4
			4	4	4			
			4.24	4.24	4.24	4.75	4.75	4.75
			4.75	4.75	4.75			
			5	5	5	6	6	6
			5.24	5.24	5.24			
			6	6	6	6.35	6.35	6.35
			6.31	6.31	6.31			
6.35	6.35	6.35	8	8	8			
GW Series   F118		● Spring clamp type. ● Simple insert clamping method. ● Possible to use the blade with both external or through coolant. ● Breaker system offering excellent chip disposal properties. ● Maximum cut off diameter : 120mm.	2.0	2.0	2.0			
			3.0	3.0	3.0			
			4.0	4.0	4.0			
			5.0	5.0	5.0			
MG Holder   F124		● Clamp-on type. ● Precision class insert. ● Positive insert suffers from negligible chattering and thus produces a good finished surface.	1.25					
			6					
SMALL TOOLS GTAH GTBH GTCH   D018		● For gang type tool posts. ● Small Shank : 8 mm—16 mm ● Possible to control the back clamping. ● High rigidity due to design of vertical insert. ● Economical due to the design of three-corner inserts.	0.3					
			3.0					
CTAH   D020		● For gang type tool posts. ● Small Shank : 8 mm—16 mm ● Due to the design of handed tool holders, able to minimize accumulation of workpieces. ● High rigidity due to design of vertical insert. ● Maximum cut off diameter :12 mm	0.7	0.7	0.7			
			1.0	1.0	1.0			
			1.5	1.5	1.5			
			2.0	2.0	2.0			
CTBH   D015		● For gang type tool posts. ● Small Shank : 10 mm—16 mm ● Single holder for inserts for back turning and cutting off. ● High rigidity due to design of vertical insert. ● Maximum cut off diameter:16 mm	1.5	1.5	1.5			
			2.0	2.0	2.0			

GROOVING / CUTTING OFF

INTERNAL CUTTING

Name of Tool Holder	Insert Shape	Features	Min. Cutting Diameter (mm)	Groove Width (mm)	Max. Groove Depth (mm)
MICRO-MINI TWIN Boring Bars   F127	—	<ul style="list-style-type: none"> ● Solid carbide type. ● Economical due to single holder with two cutting edges. 	3.0	1.0 2.0	1.0 2.0
MICRO-MINI Boring Bars   F126	—	<ul style="list-style-type: none"> ● Solid carbide type. ● Insert can be ground to suit the application. 	3.2	2.0 3.0	1.0 2.0
GY Series   F082		Modular blade type <ul style="list-style-type: none"> ● Clamp-on type. ● The modular blade allows for high rigidity and accuracy. (Triforce System) ● Various insert types. Monoblock type <ul style="list-style-type: none"> ● Spring clamp type. 	25	2 6.35	4 13



GY SERIES

A wide selection of holders and inserts available for a diverse range of grooving and cutting off applications

External • Face holders

Corresponding blades to a variety of modular holders with different shank sizes.

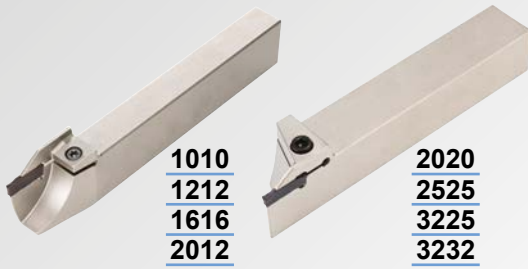

Monoblock type



Modular type

GROOVING / CUTTING OFF

Various depths of groove possible with a single tool, by using different modular blades.

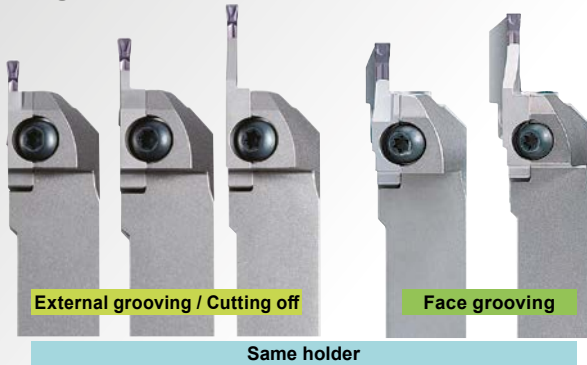

Various sizes of face grooves from a wide array of modular blades.



Internal holders

A wide range of holders available from minimum diameter of 25 mm.

Monoblock type
Min. cutting diameter
φ25, φ32



Modular type
Min. cutting diameter
φ40, φ50,
φ60, φ70



Short shank types are stock standard.

Monoblock type

Modular type



Short Standard

Short Standard

Original insert design leading the way to new grooving and cutting off applications

Highly reliable insert clamping

Safety keys prevent insert movement.

The convex geometry ensures high precision clamping.

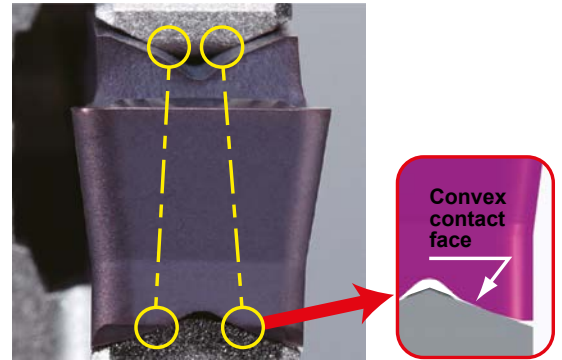
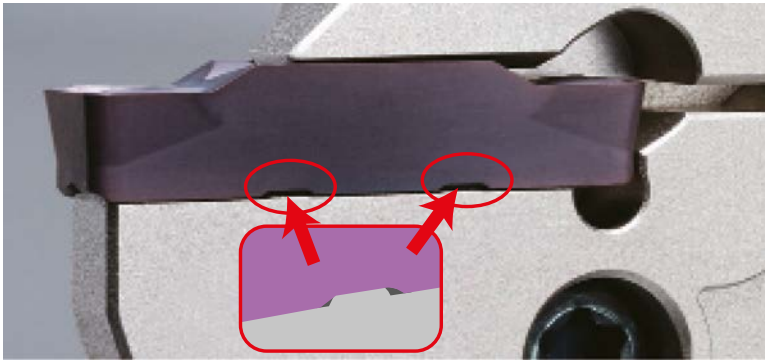

TRIFORCE System for increased stability and performance!

TRIFORCE System

The TRIFORCE system ensures the blade is securely fixed in 3 directions (side, front and top), giving high rigidity for a stable grooving and cutting performance.

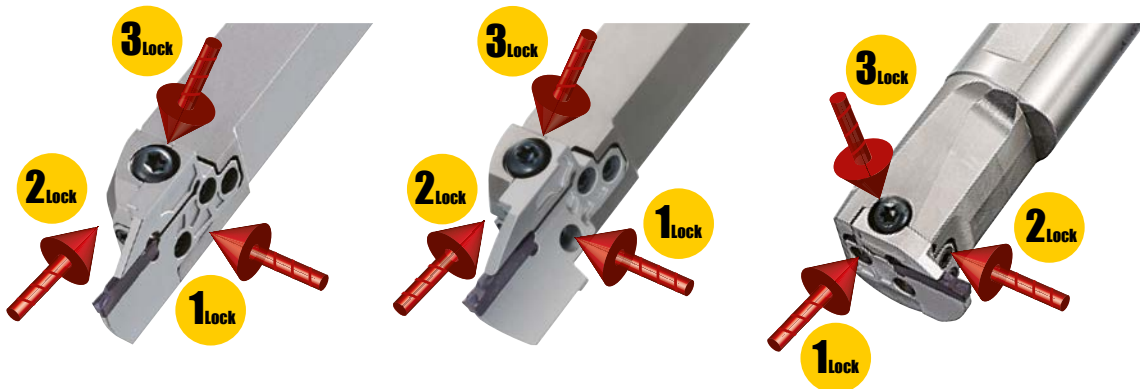

A WIDE SELECTION OF INSERTS

● Selection of groove widths



● Different corner radii available



GROOVING / CUTTING OFF

INSERT

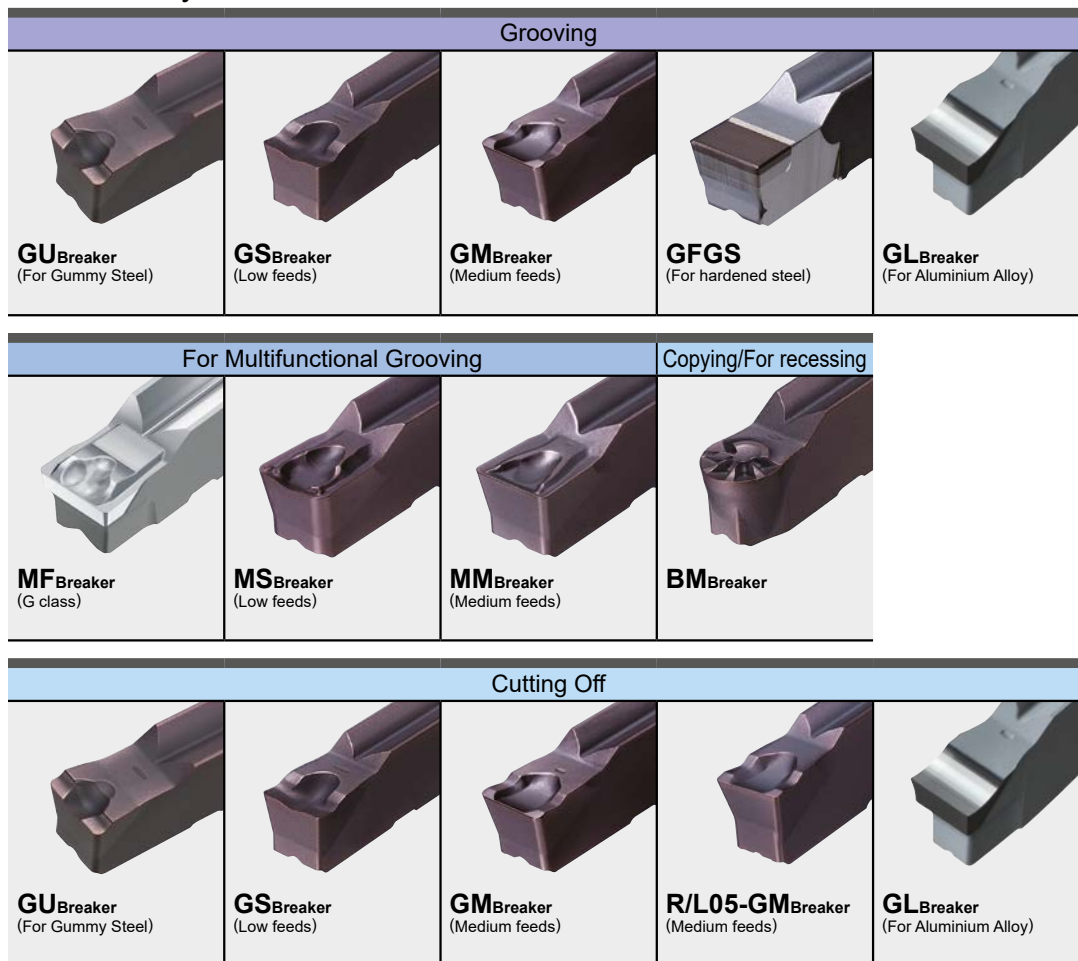

● Breaker system



GROOVING / CUTTING OFF

F

INSERT GRADE

Work Material Machining Condition	P Steel	M Stainless Steel	K Cast Iron	N Aluminium Alloy	S Heat resistant Alloy / Titanium Alloy	H Hardened Steel
	Stable  Machining Condition  Unstable	NX2525 MY5015 VP10RT VP20RT	VP10RT VP20RT	MY5015 VP10RT VP20RT	RT9010	NEW MP9015 RT9010 NEW MP9025

MP9000 Series

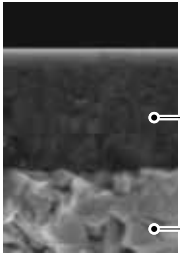

- The high Al-rich (Al, Ti)N single layer coating provides stabilization of the high hardness phase and succeeds in dramatically improving wear, crater and welding resistance.

High Al-rich (Al, Ti)N Single Layer Coating

Special Cemented Carbide Substrate

MY5015

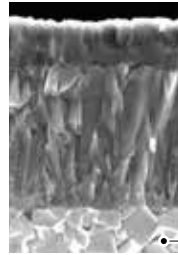

- MY5015 is a CVD coated grade with excellent wear resistance even at high temperatures. It provides longer tool life when machining cast and ductile cast irons. Also suitable for high speed continuous cutting of steels.

CVD Coated Carbide

Carbide substrate

VP20RT (1st Recommendation)

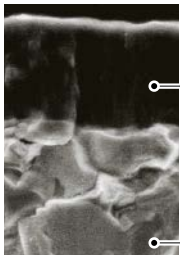

- PVD coated grade suitable for a wide range of applications. The combination of a special tough cemented carbide substrate with MIRACLE coating provides an excellent balance of wear and fracture resistance.

MIRACLE Coating

Carbide substrate (90.5HRA)

RT9010

- First recommended grade for titanium alloys. It is not recommended for use on non-ferrous alloys.

NX2525

- NX2525, a cermet grade for finish machining of steels and for good surface finishes at lower cutting speeds.

VP10RT (2nd Recommendation)

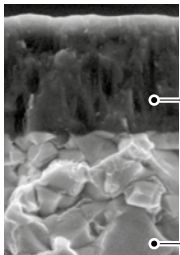

- PVD coated grade with a cemented carbide substrate harder than VP20RT. For use on difficult-to-cut materials and for extending tool life.

MIRACLE Coating

Carbide substrate (HRA92.0)

BC8110

- A coated PCBN grade for continuous cutting, which provides longer life when machining hardened steel.

BLANK INSERTS

- Blank inserts for custom grinding

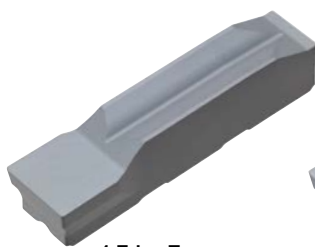

1 Edge Type



2 Edge Type

RT9010/RT9020 for blank insert

- First recommendation for blanks inserts is RT9020 due to the tougher carbide substrate that is suitable for a wider range of applications. RT9010 has a harder substrate than RT9020 and is ideal for longer tool life on stable cutting applications. Both grades are recommended to have a coating applied that is suitable for the required application.

* Blank inserts to be ground by customers.

GY SERIES ORDER NUMBER

■ INSERT

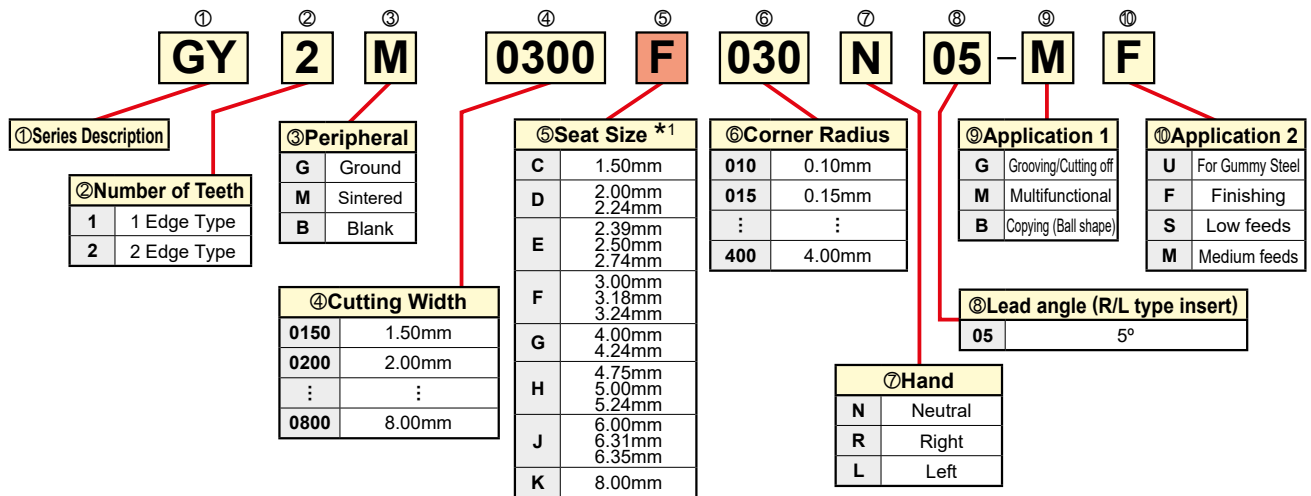

■ PCBN INSERT

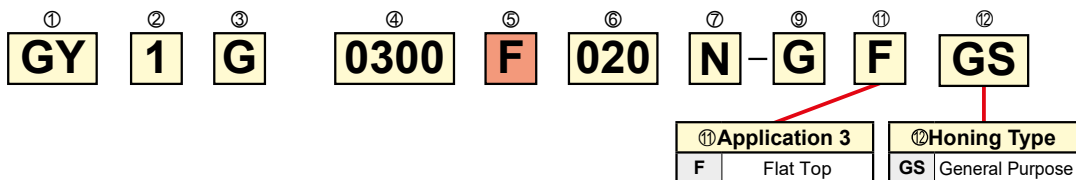

*1 Select a seat size with the same symbol as that of modular blade and monoblock holder.

■ MODULAR BLADE

● EXTERNAL/INTERNAL/FOR RECESSING

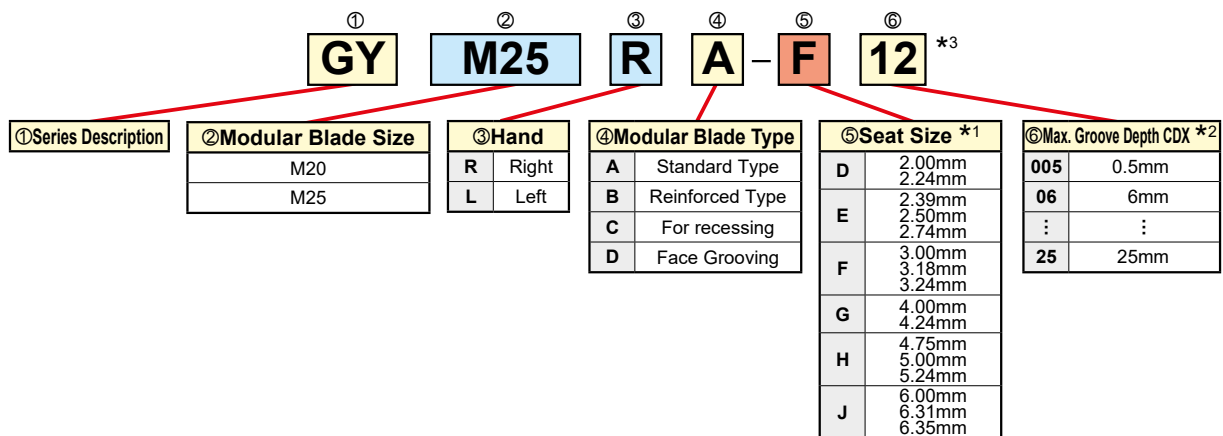

● FACE GROOVING

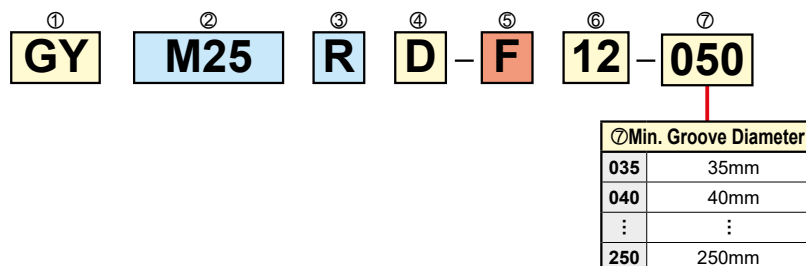

*1 Select a seat size with the same symbol as that of the insert.

*2 The maximum groove depth is a value when used for external grooving and changes according to the insert used. For internal grooving, refer to the maximum groove depth on pages F082–F088.

*3 GYM20R/LA-○10, GYM20R/LA-○12, GYM25R/LA-○12 and GYM25R/LA-○14 can be used for both external and internal grooving.

EXTERNAL / FACE GROOVING / FOR RECESSING

MONOBLOCK HOLDER

① **GY** ② **P** ③ **R** ④ **2525** ⑤ **M** ⑥ **00** - ⑦ **K** ⑧ **25**

① Series Description

③ Hand of Holder

R	Right
L	Left

② Holder Type

P	With monoblock offset
Q	Without monoblock offset
H	Modular holder

④ Shank Diameter (H x W)

1010	10x10mm
1212	12x12mm
1616	16x16mm
2012	20x12mm
2020	20x20mm
2525	25x25mm
3225	32x25mm
3232	32x32mm

⑤ Holder Length LF

J	110mm
JX	120mm
K	125mm
M	150mm
P	170mm

⑥ Angle (degree)

00	0°
50	50°
90	90°

⑦ Seat Size *1

C	1.50mm
D	2.00mm 2.24mm
E	2.39mm 2.50mm 2.74mm
F	3.00mm 3.18mm 3.24mm
G	4.00mm 4.24mm
H	4.75mm 5.00mm 5.24mm
J	6.00mm 6.31mm 6.35mm
K	8.00mm

⑧ Max. Groove Depth CDX

06	6mm
08	8mm
:	:
25	25mm

MODULAR HOLDER

① **GY** ② **H** ③ **R** ④ **2525** ⑤ **M** ⑥ **00** - ⑦ **M25** ⑧ **R**

⑦ Modular Blade Size

M20
M25

⑧ Hand of Modular Blade

R	Right
L	Left

*1 Select a seat size with the same symbol as that of the insert.

INTERNAL

MONOBLOCK HOLDER

① **GY** ② **A** ③ **R** ④ **20** ⑤ **K** ⑥ **90** ⑦ **A** - ⑧ **F** ⑨ **06**

① Series Description

③ Hand of Holder

R	Right
L	Left

② Holder Type

A	Monoblock
D	Modular holder

④ Shank Diameter DCON

20	20mm
25	25mm
32	32mm
40	40mm
50	50mm

⑤ Holder Length LF

K	125mm
L	140mm
M	150mm
P	170mm
Q	180mm
R	200mm
S	250mm
T	300mm

⑥ Angle (degree)

90	90°
----	-----

⑦ Neck Length

A	30mm
B	40mm
C	50mm
D	60mm
F	80mm

⑧ Seat Size *1

D	2.00mm 2.24mm
E	2.39mm 2.50mm 2.74mm
F	3.00mm 3.18mm 3.24mm
G	4.00mm 4.24mm
H	4.75mm 5.00mm 5.24mm
J	6.00mm 6.31mm 6.24mm

⑨ Max. Groove Depth CDX

06	6mm
07	7mm

MODULAR HOLDER

① **GY** ② **D** ③ **R** ④ **40** ⑤ **M** ⑥ **90** ⑦ **D** - ⑧ **M25** ⑨ **L**

⑧ Modular Blade Size

M20
M25

⑨ Hand of Modular Blade

R	Right
L	Left

*1 Select a seat size with the same symbol as that of the insert.

PSC HOLDER ORDER NUMBER

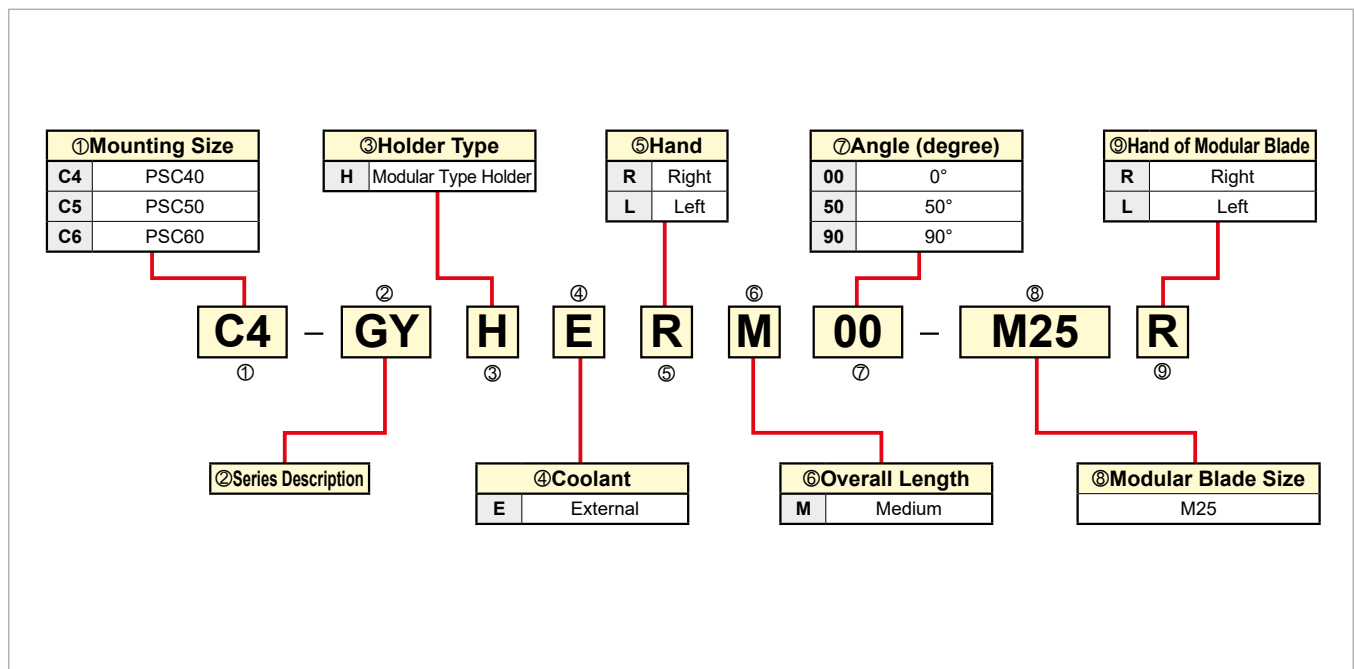

Memo

A series of horizontal dashed lines for writing, spanning the width of the page.

GY SERIES INSERTS

INSERTS

Applications	Geometry	Order Number	Stock							Seat Size	Dimensions (mm)						
			Coated			Cermet		Carbide			CW		RER/L	CDX	*2		
			NEW MP9015	MP9025	VP10RT	VP20RT	MY5015	NX2525	RT9010		RT9020	Cutting Width				Tolerance	
													L	L			
For Grooving / Cutting Off	GU Breaker (For gummy steel) 	GY2M0200D020N-GU			●	●	●				D	2.00	±0.03	0.2	19.7	20.70	
		GY2M0239E020N-GU			●	●	●				E	2.39	±0.03	0.2	19.8	20.70	
		GY2M0250E020N-GU			●	●	●				E	2.50	±0.03	0.2	19.5	20.70	
		GY2M0300F030N-GU			●	●	●				F	3.00	±0.03	0.3	19.3	20.70	
		GY2M0318F030N-GU			●	●	●				F	3.18	±0.03	0.3	19.3	20.70	
		GY2M0400G030N-GU			●	●	●				G	4.00	±0.04	0.3	24.2	25.65	
		GY2M0475H040N-GU			●	●	●				H	4.75	±0.04	0.4	24.2	25.65	
		GY2M0500H040N-GU			●	●	●				H	5.00	±0.04	0.4	24.2	25.65	
		GY2M0600J040N-GU			●	●	●				J	6.00	±0.04	0.4	24.2	25.65	
		GY2M0635J040N-GU			●	●	●				J	6.35	±0.04	0.4	24.2	25.65	
	GS Breaker (Low feeds) 	GY2M0150C010N-GS			●	●	●				C	1.50	±0.03	0.1	13.4	14.70	
		GY2M0200D020N-GS			●	●	●				D	2.00	±0.03	0.2	18.7	20.70	
		GY2M0239E020N-GS			●	●	●				E	2.39	±0.03	0.2	18.5	20.70	
		GY2M0250E020N-GS			●	●	●				E	2.50	±0.03	0.2	18.5	20.70	
		GY2M0300F020N-GS			●	●	●				F	3.00	±0.03	0.2	18.5	20.70	
		GY2M0318F020N-GS			●	●	●				F	3.18	±0.03	0.2	18.5	20.70	
		GY2M0400G020N-GS			●	●	●				G	4.00	±0.04	0.2	23.9	25.65	
		GY2M0475H030N-GS			●	●	●				H	4.75	±0.04	0.3	23.9	25.65	
		GY2M0500H030N-GS			●	●	●				H	5.00	±0.04	0.3	24.0	25.65	
		GY2M0600J030N-GS			●	●	●				J	6.00	±0.04	0.3	24.1	25.65	
	GM Breaker (Medium feeds) 	GY2M0635J030N-GS			●	●	●				J	6.35	±0.04	0.3	24.1	25.65	
		GY2M0800K030N-GS			●	●					K	8.00	±0.04	0.3	29.1	30.50	
		GY1M0200D020N-GM	●	●	●	●	●				D	2.00	±0.03	0.2	—	20.70	
		GY1M0250E020N-GM	●	●	●	●	★				E	2.50	±0.03	0.2	—	20.70	
		GY1M0300F030N-GM	●	●	●	●	●				F	3.00	±0.03	0.3	—	20.70	
		GY1M0400G030N-GM	●	●	●	●	●				G	4.00	±0.04	0.3	—	25.65	
		GY1M0500H040N-GM	●	●	●	●	●				H	5.00	±0.04	0.4	—	25.65	
		GM Breaker (Medium feeds) 	GY2M0150C020N-GM	●	●	●	●	●				C	1.50	±0.03	0.2	13.9	14.70
			GY2M0200D020N-GM	●	●	●	●	●				D	2.00	±0.03	0.2	19.4	20.70
			GY2M0239E020N-GM	●	●	●	●	●				E	2.39	±0.03	0.2	19.4	20.70
GY2M0250E020N-GM	●		●	●	●	●				E	2.50	±0.03	0.2	19.4	20.70		
GY2M0300F030N-GM	●		●	●	●	●				F	3.00	±0.03	0.3	19.4	20.70		
GY2M0318F030N-GM	●		●	●	●	●				F	3.18	±0.03	0.3	19.4	20.70		
GY2M0400G030N-GM	●		●	●	●	●				G	4.00	±0.04	0.3	24.4	25.65		
GY2M0475H040N-GM	●		●	●	●	●				H	4.75	±0.04	0.4	24.3	25.65		
GY2M0500H040N-GM	●		●	●	●	●				H	5.00	±0.04	0.4	24.3	25.65		
GY2M0600J040N-GM	●		●	●	●	●				J	6.00	±0.04	0.4	24.3	25.65		
GY2M0635J040N-GM	●	●	●	●	●				J	6.35	±0.04	0.4	24.3	25.65			
For Cutting off	R/L05-GM Breaker Right hand insert shown.	GY2M0800K050N-GM	●	●	●	●				K	8.00	±0.04	0.5	29.3	30.50		
		GY1M0200D020R05-GM			●	●					D	2.00	±0.03	0.2	—	20.80	
		GY1M0200D020L05-GM			★	●					D	2.00	±0.03	0.2	—	20.80	
		GY1M0300F030R05-GM			●	●					F	3.00	±0.03	0.3	—	20.85	
		GY1M0300F030L05-GM			●	●					F	3.00	±0.03	0.3	—	20.85	

*2 The dimension depends on the breaker. Refer to the F017 "L dimension tolerance conversion table".

● : Inventory maintained. ★ : Inventory maintained in Japan.

(10 inserts in one case) (CBN inserts are available in 1 piece in one case.)

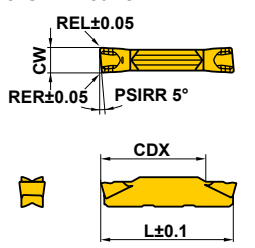
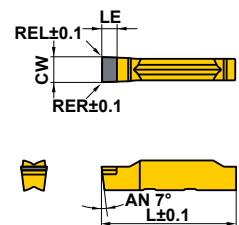
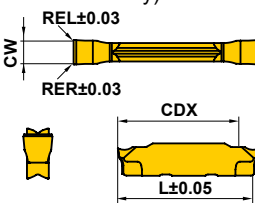
Applications	Geometry	Order Number	Stock						Seat Size	Dimensions (mm)						
			Coated			Carbide CBN				CW		RER/L	CDX	L	*2	LE
			NEW	VP10RT	VP20RT	RT9010	BC8110	Cutting Width		Tolerance						
			MP9015	MP9025												
For Cutting Off	R/L05-GM Breaker  Right hand insert shown.	GY2M0200D020R05-GM			●	●				D	2.00	±0.03	0.2	19.5	20.80	—
		GY2M0200D020L05-GM			●	●				D	2.00	±0.03	0.2	19.5	20.80	—
		GY2M0250E020R05-GM			●	●				E	2.50	±0.03	0.2	19.5	20.825	—
		GY2M0250E020L05-GM			●	●				E	2.50	±0.03	0.2	19.5	20.825	—
		GY2M0300F030R05-GM			●	●				F	3.00	±0.03	0.3	19.5	20.85	—
		GY2M0300F030L05-GM			●	●				F	3.00	±0.03	0.3	19.5	20.85	—
		GY2M0400G030R05-GM			●	●				G	4.00	±0.04	0.3	24.5	25.85	—
		GY2M0400G030L05-GM			●	●				G	4.00	±0.04	0.3	24.5	25.85	—
		GY2M0500H040R05-GM			●	●				H	5.00	±0.04	0.4	24.5	25.95	—
		GY2M0500H040L05-GM			●	●				H	5.00	±0.04	0.4	24.5	25.95	—
For Grooving	Flat Top (For hardened steel) 	GY1G0200D020N-GFGS						●	D	2.00	±0.03	0.2	—	20.70	2.7	
		GY1G0239E020N-GFGS						●	E	2.39	±0.03	0.2	—	20.70	2.7	
		GY1G0250E020N-GFGS						●	E	2.50	±0.03	0.2	—	20.70	2.7	
		GY1G0300F020N-GFGS						●	F	3.00	±0.03	0.2	—	20.70	2.7	
		GY1G0318F020N-GFGS						●	F	3.18	±0.03	0.2	—	20.70	2.7	
		GY1G0400G020N-GFGS						●	G	4.00	±0.03	0.2	—	25.65	2.7	
		GY1G0475H020N-GFGS						●	H	4.75	±0.03	0.2	—	25.65	2.7	
		GY1G0500H020N-GFGS						●	H	5.00	±0.03	0.2	—	25.65	2.7	
		GY1G0600J020N-GFGS						●	J	6.00	±0.03	0.2	—	25.65	2.7	
		For Grooving / Cutting Off	GL Breaker (For Aluminium Alloy) 	GY2G0200D005N-GL					●		D	2.00	±0.02	0.05	19.5	21.05
GY2G0250E005N-GL							●		E	2.50	±0.02	0.05	19.1	21.05	—	
GY2G0300F005N-GL							●		F	3.00	±0.02	0.05	18.9	21.05	—	



 GROOVING / CUTTING OFF

GY SERIES INSERTS

INSERTS

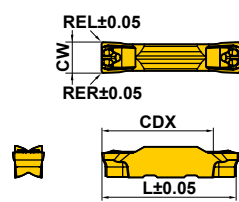
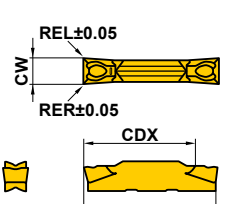
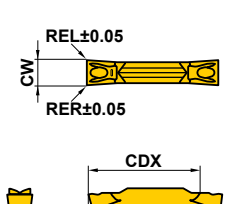
Applications	Geometry	Order Number	Stock						Seat Size	Dimensions (mm)						
			Coated			Cermet	Carbide			CW		RE RER/L	CDX	*2		
			NEW	VP10RT	VP20RT	MY5015	NX2525	RT9010		RT9020	Cutting Width				Tolerance	
			MP9015	MP9025												
For Multifunctional Grooving	MF Breaker (Finishing) 	GY2G0200D020N-MF			●	●	●	●	D	2.00	±0.02	0.2	19.5	21.05		
		*1 GY2G0224D015N-MF			●	●	●	●	D	2.24	±0.02	0.15	19.8	21.05		
		GY2G0239E020N-MF			★	★	★	★	E	2.39	±0.02	0.2	19.2	21.05		
		GY2G0250E020N-MF			●	●	●	●	E	2.50	±0.02	0.2	19.4	21.05		
		*1 GY2G0274E020N-MF			●	●	●	●	E	2.74	±0.02	0.2	19.7	21.05		
		GY2G0300F020N-MF			●	●	●	●	F	3.00	±0.02	0.2	19.5	21.05		
		GY2G0300F040N-MF			●	●	●	●	F	3.00	±0.02	0.4	19.3	21.05		
		GY2G0318F020N-MF			★	★	★	★	F	3.18	±0.02	0.2	19.5	21.05		
		GY2G0318F040N-MF			★	★	★	★	F	3.18	±0.02	0.4	19.3	21.05		
		*1 GY2G0324F020N-MF			●	●	●	●	F	3.24	±0.02	0.2	19.5	21.05		
		GY2G0400G020N-MF			●	●	●	●	G	4.00	±0.02	0.2	24.9	25.95		
		GY2G0400G040N-MF			●	●	●	●	G	4.00	±0.02	0.4	24.7	25.95		
		GY2G0400G080N-MF			●	●	●	●	G	4.00	±0.02	0.8	24.3	25.95		
		*1 GY2G0424G020N-MF			●	●	●	●	G	4.24	±0.02	0.2	24.9	25.95		
		GY2G0475H020N-MF			★	★	★	★	H	4.75	±0.02	0.2	24.4	25.95		
		GY2G0475H040N-MF			★	★	★	★	H	4.75	±0.02	0.4	24.2	25.95		
		GY2G0475H080N-MF			★	★	★	★	H	4.75	±0.02	0.8	23.8	25.95		
		GY2G0500H020N-MF			●	●	●	●	H	5.00	±0.02	0.2	24.4	25.95		
		GY2G0500H040N-MF			●	●	●	●	H	5.00	±0.02	0.4	24.2	25.95		
		GY2G0500H080N-MF			●	●	●	●	H	5.00	±0.02	0.8	23.8	25.95		
		*1 GY2G0524H020N-MF			●	●	●	●	H	5.24	±0.02	0.2	24.4	25.95		
		GY2G0600J020N-MF			●	●	●	●	J	6.00	±0.02	0.2	24.4	25.95		
		GY2G0600J040N-MF			●	●	●	●	J	6.00	±0.02	0.4	24.2	25.95		
		GY2G0600J080N-MF			●	●	●	●	J	6.00	±0.02	0.8	23.8	25.95		
		*1 GY2G0631J020N-MF			●	●	●	●	J	6.31	±0.02	0.2	24.4	25.95		
		GY2G0635J020N-MF			★	★	★	★	J	6.35	±0.02	0.2	24.4	25.95		
		GY2G0635J040N-MF			★	★	★	★	J	6.35	±0.02	0.4	24.2	25.95		
		GY2G0635J080N-MF			★	★	★	★	J	6.35	±0.02	0.8	23.8	25.95		
		For Multifunctional Grooving	MS Breaker (Low feeds) 	GY2M0200D020N-MS			●	●	●	●	D	2.00	±0.03	0.2	19.1	20.70
				GY2M0250E020N-MS			●	●	●	●	E	2.50	±0.03	0.2	19.1	20.70
GY2M0300F020N-MS					●	●	●	●	F	3.00	±0.03	0.2	19.2	20.70		
GY2M0300F040N-MS					●	●	●	●	F	3.00	±0.03	0.4	18.9	20.70		
GY2M0400G020N-MS					●	●	●	●	G	4.00	±0.04	0.2	24.2	25.65		
GY2M0400G040N-MS					●	●	●	●	G	4.00	±0.04	0.4	23.9	25.65		
GY2M0500H040N-MS					●	●	●	●	H	5.00	±0.04	0.4	23.9	25.65		
GY2M0500H080N-MS					●	●	●	●	H	5.00	±0.04	0.8	23.5	25.65		
GY2M0600J040N-MS					●	●	●	●	J	6.00	±0.04	0.4	23.9	25.65		
GY2M0600J080N-MS					●	●	●	●	J	6.00	±0.04	0.8	23.5	25.65		
GY2M0800K080N-MS					●	●	●	●	K	8.00	±0.04	0.8	28.5	30.50		
For Multifunctional Grooving	MM Breaker (Medium feeds) 	GY2M0200D020N-MM	●	●	●	●	●	●	D	2.00	±0.03	0.2	19.1	20.70		
		GY2M0250E020N-MM	●	●	●	●	●	●	●	E	2.50	±0.03	0.2	19.1	20.70	
		GY2M0300F020N-MM	●	●	●	●	●	●	●	F	3.00	±0.03	0.2	19.1	20.70	
		GY2M0300F040N-MM	●	●	●	●	●	●	●	F	3.00	±0.03	0.4	18.9	20.70	
		GY2M0300F080N-MM	●	●	●	●	●	●	●	F	3.00	±0.03	0.8	18.5	20.70	
		GY2M0400G020N-MM	●	●	●	●	●	●	●	G	4.00	±0.04	0.2	24.1	25.65	
		GY2M0400G040N-MM	●	●	●	●	●	●	●	G	4.00	±0.04	0.4	23.9	25.65	
		GY2M0400G080N-MM	●	●	●	●	●	●	●	G	4.00	±0.04	0.8	23.5	25.65	
		GY2M0500H040N-MM	●	●	●	●	●	●	●	H	5.00	±0.04	0.4	23.9	25.65	
		GY2M0500H080N-MM	●	●	●	●	●	●	●	H	5.00	±0.04	0.8	23.5	25.65	
		GY2M0600J040N-MM	●	●	●	●	●	●	●	J	6.00	±0.04	0.4	23.9	25.65	
		GY2M0600J080N-MM	●	●	●	●	●	●	●	J	6.00	±0.04	0.8	23.5	25.65	
		GY2M0800K080N-MM	●	●	●	●	●	●	●	K	8.00	±0.04	0.8	28.5	30.50	
GY2M0800K120N-MM	●	●	●	●	●	●	●	K	8.00	±0.04	1.2	28.1	30.50			

*1 Groove width corresponding to the circlip.

*2 The dimension depends on the breaker. Refer to the F017 "L dimension tolerance conversion table".

● : Inventory maintained. ★ : Inventory maintained in Japan.

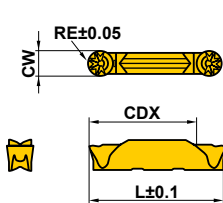
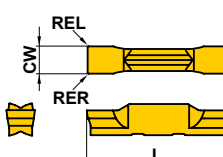
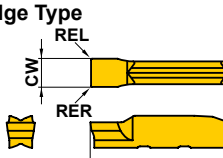
Applications	Geometry	Order Number	Stock							Seat Size	Dimensions (mm)						
			Coated			Cermet		Carbide			CW		RE RER/L	CDX	*2 L		
			NEW MP9015	MP9025	VP10RT	VP20RT	MY5015	NX2525	RT9010		RT9020	Cutting Width				Tolerance	
			●	●	●	●	●	●	●		●						
For Copying / For Recessing	BM Breaker 	GY2M0200D100N-BM	●	●	●	●	●	●			D	2.00	±0.03	1.00	19.5	20.90	
		GY2M0250E125N-BM	●	●	●	●	●	●	●			E	2.50	±0.03	1.25	19.3	20.90
		GY2M0300F150N-BM	●	●	●	●	●	●	●			F	3.00	±0.03	1.50	19.0	20.90
		GY2M0318F159N-BM	●	●	●	●	●	●	●			F	3.18	±0.03	1.59	18.9	20.90
		GY2M0400G200N-BM	●	●	●	●	●	●	●			G	4.00	±0.04	2.00	23.4	25.80
		GY2M0475H238N-BM	●	●	●	●	●	●	●			H	4.75	±0.04	2.38	22.9	25.80
		GY2M0500H250N-BM	●	●	●	●	●	●	●			H	5.00	±0.04	2.50	22.8	25.80
		GY2M0600J300N-BM	●	●	●	●	●	●	●			J	6.00	±0.04	3.00	22.5	25.90
		GY2M0635J318N-BM	●	●	●	●	●	●	●			J	6.35	±0.04	3.18	22.3	25.90
		GY2M0800K400N-BM	●	●	●	●	●	●	●			K	8.00	±0.04	4.00	26.5	30.80
*1 Blank	2 Edge Type 	GY2B0220D020N						●	●	●	D	2.20	±0.10	0.2	—	21.05	
		NEW GY2B0250D020N						●	●	●	D	2.55	±0.10	0.2	—	21.28	
		GY2B0270E020N						●	●	●	E	2.70	±0.10	0.2	—	21.05	
		NEW GY2B0300E020N						●	●	●	E	3.05	±0.10	0.2	—	21.28	
		GY2B0340F020N						●	●	●	F	3.40	±0.10	0.2	—	21.05	
		NEW GY2B0360F020N						●	●	●	F	3.65	±0.10	0.2	—	21.28	
		GY2B0420G020N						●	●	●	G	4.20	±0.10	0.2	—	26.00	
		NEW GY2B0460G020N						●	●	●	G	4.65	±0.10	0.2	—	26.18	
		GY2B0520H020N						●	●	●	H	5.20	±0.10	0.2	—	26.00	
		NEW GY2B0560H020N						●	●	●	H	5.65	±0.10	0.2	—	26.18	
		GY2B0655J020N						●	●	●	J	6.55	±0.10	0.2	—	26.03	
		NEW GY2B0680J020N						●	●	●	J	6.85	±0.10	0.2	—	26.18	
	NEW GY2B0880K020N							●	●	●	K	8.85	±0.10	0.2	—	30.88	
	1 Edge Type 	GY1B0220D020N						●	●	●	D	2.20	±0.10	0.2	—	21.07	
		GY1B0270E020N						●	●	●	E	2.70	±0.10	0.2	—	21.10	
		GY1B0340F020N						●	●	●	F	3.40	±0.10	0.2	—	21.00	
		GY1B0420G020N						●	●	●	G	4.20	±0.10	0.2	—	25.86	
		GY1B0520H020N						●	●	●	H	5.20	±0.10	0.2	—	25.90	
		GY1B0655J020N						●	●	●	J	6.55	±0.10	0.2	—	25.90	

*1 Groove width corresponding to the circlip.

*2 The dimension depends on the breaker. Refer to the F017 "L dimension tolerance conversion table".



T

GROOVING / CUTTING OFF

GROOVING / CUTTING OFF

Reference Material

C-TYPE CIRCLIP STANDARDS LIST

Category	Application		Standard	Width (Tolerance)											
				For shaft				For hole							
 C-type stop ring	For shaft	For hole		0.5	+0.14 0	0.305	+0.051	1.15	+0.14 0	9	+0.14 0	0.457	+0.051		
				0.7		0.457	0	1.35				1.1	0.737	+0.076	
				0.8		0.737		1.75				1.3	0.991	0	
				0.9		0.991	+0.076	1.95				1.6	1.168	0	
				1.1		1.168	0	2.2				1.85	1.422	+0.102	
				1.3		1.422	+0.102	2.7				2.15	1.727	0	
				1.6		1.727	0	3.2		+0.18		2.65	1.727	0	
				1.85		2.184	+0.127	4.2		0		3.15	2.184	+0.127	
				2.15		2.616	0					4.15	2.616	0	
				2.65		3.048	+0.152					5.15	3.048	0	
	3.531	+0.152			6.2		+0.22 0								
	6.2	+0.22 0													
 C-type concentric stop ring	For shaft	For hole	ANSI B27.7/27.8 (US) BS 3673 (UK) DIN 471/472 (De) NF E 22 163 (Fr) UNI 7435/7438 (It)												
			JIS B 2804 (JP)												
 E-type stop ring	For shaft		N1*** American	0.32	+0.05 0	0.305	+0.051 0	0.3	+0.05 0						
			0.5	0	0.457	0	0.4	0							
			0.7	+0.10 0	0.584		0.5								
			1.0	0	0.737	+0.076 0	0.7	+0.10 0							
			1.2	+0.14 0	0.991	0	0.9	0							
			1.4	0	1.168	0	1.15								
		1.422	+0.102 0	1.75	+0.14 0										
		1.727	0	2.2											

F

GROOVING / CUTTING OFF

O-RING STANDARDS

Category	Standard	Width (Tolerance)					
		General		For oil pressure		For air pressure	
For stable	DIN 3770/3771 (De)	2.54	+0.13 0	1.9	+0.1 0	2.3	+0.2 0
		3.18		2.3	0	3.1	
	4.32	2.9		+0.15 0	3.7		
	6.1	3.6		+0.2 0	6.4		
JIS B 2401 (JP) ISO 3601	3.2	+0.14 0	4.5	0	9.0		
	4.0		5.5	+0.3 0	2.4		
SMS 1586/1588 (Se) BS 1806/4518 (UK)	7.5	+0.25 0	7.0	0	3.6	+0.25 0	
	11.0		10.7	+0.5 0	4.8		
For dynamic	SAE AS-568 (US)	2.39	+0.25 0	8.6	+0.4 0	7.1	+0.25 0
		3.58		10.7	0	9.5	
		4.78		2.3	+0.2 0	3.4	
		7.14		3.1	0	4.6	
9.58	3.7	0	6.9				
	6.4	0	9.3				

- G-class insert with MF breaker is available for single-step machining.
- Conventional GY series insert is available for single-step machining.
- Machined in multiple steps or by cross feed machining.

L DIMENSION TOLERANCE CONVERSION TABLE

Cutting Width CW (mm)	*1 Dimensions L (mm)	*2 Dimensional tolerance (mm) versus standard dimension (L) of each breaker						
		GU	GS/GM	MS/MM	R/L-GM	Flat Top	MF	BM
1.50	14.70		0					
2.00	20.70	0	0	0	0.10	0	0.35	0.20
2.24	*3 (20.7)						0.35	
2.39	20.70	0	0			0	0.35	
2.50	20.70	0	0	0	0.125	0	0.35	0.20
2.74	*3 (20.7)						0.35	
3.00	20.70	0	0	0	0.15	0	0.35	0.20
3.18	20.70	0	0			0	0.35	0.20
3.24	*3 (20.7)						0.35	
4.00	25.65	0	0	0	0.20	0	0.30	0.15
4.24	*3 (25.65)						0.30	
4.75	25.65	0	0			0	0.30	0.15
5.00	25.65	0	0	0	0.30	0	0.30	0.15
5.24	*3 (25.65)						0.30	
6.00	25.65	0	0	0		0	0.30	0.25
6.31	*3 (25.65)						0.30	
6.35	25.65	0	0				0.30	0.25
8.00	30.50		0	0				0.30

*1 This value is used at the described holder dimension.

*2 when there is no applicable breaker.

*3 The standard dimensions shown here use an approximate insert width.

* Wrench : ① : Clamp Screw, ② : Blade Screw

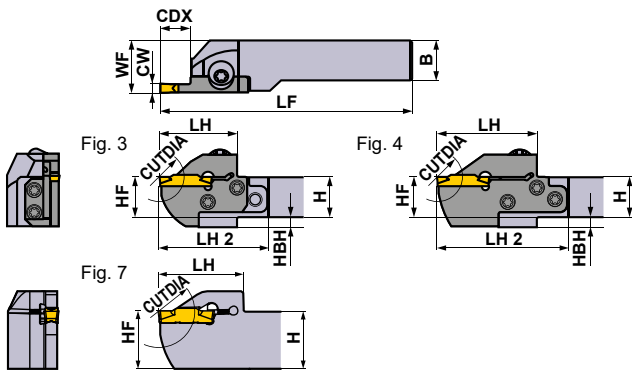

Right hand tool holder shown.

SPARE PARTS

Holder	Clamp Screw	Blade Screw 5 pcs.	Wrench *
GYQR/L	HSC05020 (Clamp Torque : 7.0N·m)	—	HKY40R
GYHR/L	GY06013M (Clamp Torque : 6.0N·m)	TS407 (Clamp Torque : 3.5N·m)	①TKY30R ②TKY15D
GYHR/L			TS55 (Clamp Torque : 5.0N·m)

Dimensions (mm) *3									Cutting Mode	
H	B	LF	LH	LH 2	HF	WF	HBH		Clockwise	Anticlockwise
16	16	104	28	44	16	20	4		R	
16	16	104	28	44	16	20	4			
20	20	125	36	—	20	20.15	—			
20	20	125	36	—	20	20.15	—			
20	20	119	28	43	20	23	—			
20	20	119	28	43	20	23	—			
20	20	117	31	52	20	26	5			
20	20	117	31	52	20	26	5			
25	25	150	36	—	25	25.15	—			
25	25	150	36	—	25	25.15	—			
25	25	142	31	49	25	28	—			
25	25	142	31	49	25	28	—			
32	25	162	31	49	32	28	—			
32	25	162	31	49	32	28	—			
32	32	162	31	49	32	35	—			
32	32	162	31	49	32	35	—			
16	16	110	34	50	16	20	4		L	
16	16	110	34	50	16	20	4			
20	20	125	34	49	20	23	—			
20	20	125	34	49	20	23	—			
20	20	125	39	60	20	26	5			
20	20	125	39	60	20	26	5			
25	25	150	39	57	25	28	—			
25	25	150	39	57	25	28	—			
32	25	170	39	57	32	28	—			
32	25	170	39	57	32	28	—			
32	32	170	39	57	32	35	—			
32	32	170	39	57	32	35	—			
16	16	116	40	56	16	20	4			
16	16	116	40	56	16	20	4			
20	20	125	39	—	20	20.1	—			
20	20	125	39	—	20	20.1	—			
20	20	131	40	55	20	23	—			
20	20	131	40	55	20	23	—			
20	20	131	45	66	20	26	5			
20	20	131	45	66	20	26	5			
25	25	150	41	—	25	25.1	—			
25	25	150	41	—	25	25.1	—			
25	25	156	45	63	25	28	—			
25	25	156	45	63	25	28	—			
32	25	176	45	63	32	28	—			
32	25	176	45	63	32	28	—			
32	32	176	45	63	32	35	—			
32	32	176	45	63	32	35	—			

Insert selection

Seat Size	Geometry name
D	GY000200/0224D0000-Breaker shown below

For grooving/cutting off breaker > F012, F013						
Seat Size	Breaker	GU	GS	GM	GL	GFGS
		(For gummy steel)	(Low)	(Medium)	(Aluminium alloy)	(Hardened steel)
CW		Neutral	Neutral	Neutral	Neutral	With hand
	D	2.00mm	●	●	●	●

For multifunctional grooving breaker > F014, F015					
Seat Size	Breaker	MF	MS	MM	BM
		(Finish)	(Low)	(Medium)	(Copying, Recessing)
CW					Ball shape
	D	2.00mm	●	●	●
	2.24mm	●			

● : Standard insert with dimensions

GROOVING / CUTTING OFF

IDENTIFICATION > F008, F009
 CUTTING CONDITIONS > F096
 CAUTION FOR USE > F100

GY SERIES (EXTERNAL)

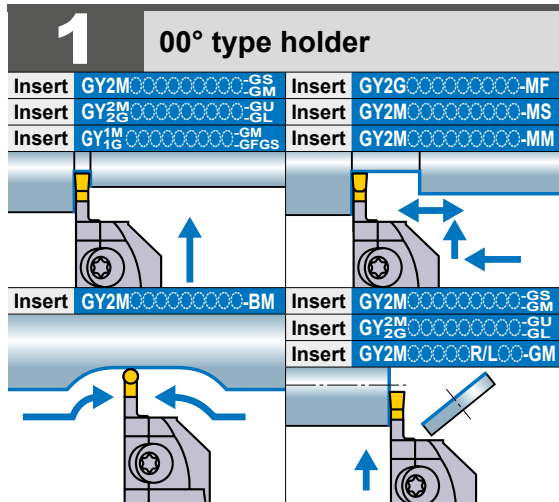

Note 1) For modular blades and modular holders, please order separately.
 Note 2) Please use right hand modular blade for right hand holder and left hand modular blade for left hand holder.

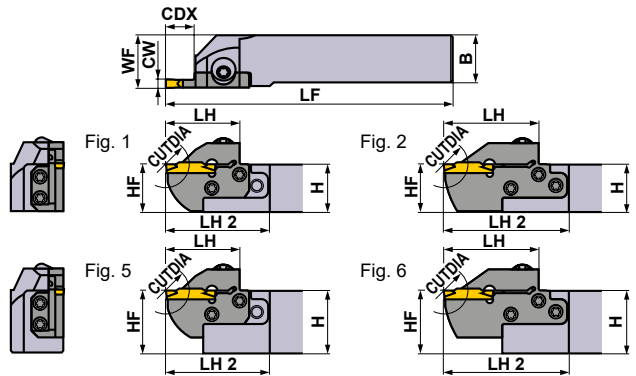

Right hand tool holder shown.

Seat Size	Dimensions (mm)			Type	Hand (R/L)	Order Number				Fig.
	CW	CDX	CUTDIA			Holder	Stock	Modular Blade	Stock	
E	2.39 2.50 2.74	6	12	Modular	R	GYHR1616J00-M20R	●	GYM20RA-E06	●	3
				Modular	L	GYHL1616J00-M20L	●	GYM20LA-E06	●	3
				Modular	R	GYHR2020K00-M20R	●	GYM20RA-E06	●	1
				Modular	L	GYHL2020K00-M20L	●	GYM20LA-E06	●	1
				Modular	R	GYHR2020K00-M25R	●	GYM25RA-E06	●	3
				Modular	L	GYHL2020K00-M25L	●	GYM25LA-E06	●	3
		Modular	R	GYHR2525M00-M25R	●	GYM25RA-E06	●	1		
		Modular	L	GYHL2525M00-M25L	●	GYM25LA-E06	●	1		
		Modular	R	GYHR3225P00-M25R	●	GYM25RA-E06	●	5		
		Modular	L	GYHL3225P00-M25L	●	GYM25LA-E06	●	5		
		Modular	R	GYHR3232P00-M25R	●	GYM25RA-E06	●	5		
		Modular	L	GYHL3232P00-M25L	●	GYM25LA-E06	●	5		
	Modular	R	GYHR1616J00-M20R	●	GYM20RA-E10	●	3			
	Modular	L	GYHL1616J00-M20L	●	GYM20LA-E10	●	3			
	Modular	R	GYHR2020K00-M20R	●	GYM20RA-E10	●	1			
	Modular	L	GYHL2020K00-M20L	●	GYM20LA-E10	●	1			
	Modular	R	GYHR2020K00-M25R	●	GYM25RA-E12	●	3			
	Modular	L	GYHL2020K00-M25L	●	GYM25LA-E12	●	3			
	Modular	R	GYHR2525M00-M25R	●	GYM25RA-E12	●	1			
	Modular	L	GYHL2525M00-M25L	●	GYM25LA-E12	●	1			
	Modular	R	GYHR3225P00-M25R	●	GYM25RA-E12	●	5			
	Modular	L	GYHL3225P00-M25L	●	GYM25LA-E12	●	5			
	Modular	R	GYHR3232P00-M25R	●	GYM25RA-E12	●	5			
	Modular	L	GYHL3232P00-M25L	●	GYM25LA-E12	●	5			
Modular	R	GYHR1616J00-M20R	●	GYM20RB-E18	●	4				
Modular	L	GYHL1616J00-M20L	●	GYM20LB-E18	●	4				
Modular	R	GYHR2020K00-M20R	●	GYM20RB-E18	●	2				
Modular	L	GYHL2020K00-M20L	●	GYM20LB-E18	●	2				
Modular	R	GYHR2020K00-M25R	●	GYM25RA-E20	●	4				
Modular	L	GYHL2020K00-M25L	●	GYM25LA-E20	●	4				
Modular	R	GYHR2525M00-M25R	●	GYM25RA-E20	●	2				
Modular	L	GYHL2525M00-M25L	●	GYM25LA-E20	●	2				
Modular	R	GYHR3225P00-M25R	●	GYM25RA-E20	●	6				
Modular	L	GYHL3225P00-M25L	●	GYM25LA-E20	●	6				
Modular	R	GYHR3232P00-M25R	●	GYM25RA-E20	●	6				
Modular	L	GYHL3232P00-M25L	●	GYM25LA-E20	●	6				

*1 The maximum groove depth (CDX) varies according to the insert used. Please refer to the maximum groove depth (CDX) of inserts on pages F012–F015.
 *2 The maximum cut off diameter (CUTDIA) varies according to the insert used.
 The cut off diameter is double the maximum groove depth (CDX) of inserts on pages F012–F015.
 *3 Dimensions shown are when the standard insert is used. If other insert geometries are used then LF, LH, LH2 and WF values may vary.
 *4 The maximum groove depth (CDX) is limited by the workpiece diameter. For details, please refer to page F098.

● : Inventory maintained.

GROOVING / CUTTING OFF

* Wrench : ① : Clamp Screw, ② : Blade Screw

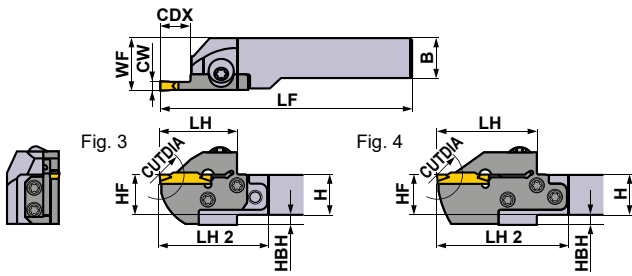

Right hand tool holder shown.

SPARE PARTS			
Holder		5 pcs.	① ②
	Clamp Screw	Blade Screw	Wrench *
GYQR/L	HSC05020 (Clamp Torque : 7.0N·m)	—	HKY40R
GYHR/L	GY06013M (Clamp Torque : 6.0N·m)	TS407 (Clamp Torque : 3.5N·m)	①TKY30R ②TKY15D
GYHR/L			TS55 (Clamp Torque : 5.0N·m)

Dimensions (mm) *3									Cutting Mode	
H	B	LF	LH	LH 2	HF	WF	HBH		Clockwise	Anticlockwise
16	16	104	28	44	16	20	4	R		
16	16	104	28	44	16	20	4			
20	20	119	28	43	20	23	—			
20	20	119	28	43	20	23	—			
20	20	117	31	52	20	26	5			
20	20	117	31	52	20	26	5			
25	25	142	31	49	25	28	—			
25	25	142	31	49	25	28	—			
32	25	162	31	49	32	28	—			
32	25	162	31	49	32	28	—			
32	32	162	31	49	32	35	—	L		
32	32	162	31	49	32	35	—			
16	16	110	34	50	16	20	4			
16	16	110	34	50	16	20	4			
20	20	125	34	49	20	23	—			
20	20	125	34	49	20	23	—			
20	20	125	39	60	20	26	5			
20	20	125	39	60	20	26	5			
25	25	150	39	57	25	28	—			
25	25	150	39	57	25	28	—			
32	25	170	39	57	32	28	—	L		
32	25	170	39	57	32	28	—			
32	32	170	39	57	32	35	—			
32	32	170	39	57	32	35	—			
16	16	116	40	56	16	20	4			
16	16	116	40	56	16	20	4			
20	20	131	40	55	20	23	—			
20	20	131	40	55	20	23	—			
20	20	131	45	66	20	26	5			
20	20	131	45	66	20	26	5			
25	25	156	45	63	25	28	—	L		
25	25	156	45	63	25	28	—			
32	25	176	45	63	32	28	—			
32	25	176	45	63	32	28	—			
32	32	176	45	63	32	35	—			
32	32	176	45	63	32	35	—			

Insert selection

Seat Size	Geometry name
E	GY0239/0250/0274E Breaker shown below

For grooving/cutting off breaker > F012, F013							
Seat Size	Breaker	GU	GS	GM	GL	GFGS	
		(For gummy steel)	(Low)	(Medium)	(Aluminium alloy)	(Cutting off)	(Hardened steel)
CW		Neutral	Neutral	Neutral	Neutral	With hand	Neutral
	2.39mm	●	●	●	●	●	●
E	2.50mm	●	●	●	●	●	●

For multifunctional grooving breaker > F014, F015					
Seat Size	Breaker	MF	MS	MM	BM
		(Finish)	(Low)	(Medium)	(Copying, Recessing)
CW					Ball shape
	2.39mm	●			
	2.50mm	●	●	●	●
E	2.74mm	●			

● : Standard insert with dimensions

GROOVING / CUTTING OFF

IDENTIFICATION > F008, F009
 CUTTING CONDITIONS > F096
 CAUTION FOR USE > F100

GY SERIES (EXTERNAL)

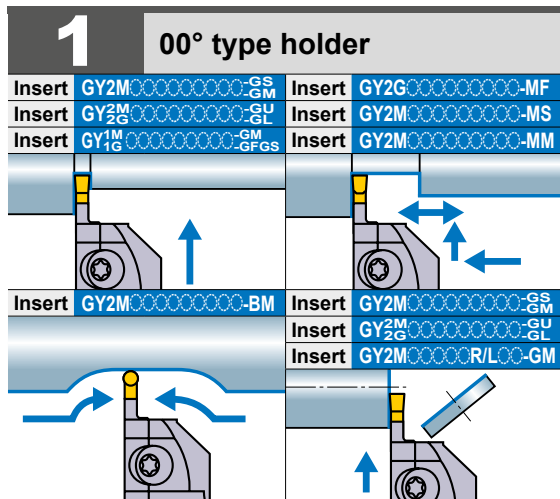

Note 1) For modular blades and modular holders, please order separately.
 Note 2) Please use right hand modular blade for right hand holder and left hand modular blade for left hand holder.

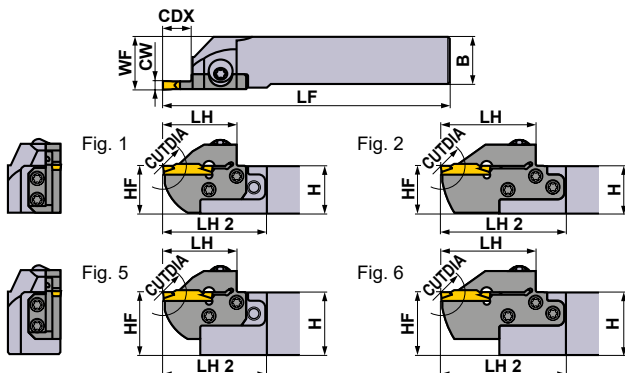

Right hand tool holder shown.

Seat Size	Dimensions (mm)			Type	Hand (R/L)	Order Number				Fig.
	CW	CDX	CUTDIA			Holder	Stock	Modular Blade	Stock	
F	3.00 3.18 3.24	6	12	Modular	R	GYHR1616J00-M20R	●	GYM20RA-F06	●	3
				Modular	L	GYHL1616J00-M20L	●	GYM20LA-F06	●	3
				Monoblock	R	GYQR2020K00-F06	●	—	—	7
				Monoblock	L	GYQL2020K00-F06	●	—	—	7
				Modular	R	GYHR2020K00-M20R	●	GYM20RA-F06	●	1
				Modular	L	GYHL2020K00-M20L	●	GYM20LA-F06	●	1
				Modular	R	GYHR2020K00-M25R	●	GYM25RA-F06	●	3
				Modular	L	GYHL2020K00-M25L	●	GYM25LA-F06	●	3
		Monoblock	R	GYQR2525M00-F06	●	—	—	7		
		Monoblock	L	GYQL2525M00-F06	●	—	—	7		
		Modular	R	GYHR2525M00-M25R	●	GYM25RA-F06	●	1		
		Modular	L	GYHL2525M00-M25L	●	GYM25LA-F06	●	1		
		Modular	R	GYHR3225P00-M25R	●	GYM25RA-F06	●	5		
		Modular	L	GYHL3225P00-M25L	●	GYM25LA-F06	●	5		
		Modular	R	GYHR3232P00-M25R	●	GYM25RA-F06	●	5		
		Modular	L	GYHL3232P00-M25L	●	GYM25LA-F06	●	5		
	10	20	Modular	R	GYHR1616J00-M20R	●	GYM20RA-F10	●	3	
			Modular	L	GYHL1616J00-M20L	●	GYM20LA-F10	●	3	
		Modular	R	GYHR2020K00-M20R	●	GYM20RA-F10	●	1		
		Modular	L	GYHL2020K00-M20L	●	GYM20LA-F10	●	1		
		Modular	R	GYHR2020K00-M25R	●	GYM25RA-F12	●	3		
		Modular	L	GYHL2020K00-M25L	●	GYM25LA-F12	●	3		
		Modular	R	GYHR2525M00-M25R	●	GYM25RA-F12	●	1		
		Modular	L	GYHL2525M00-M25L	●	GYM25LA-F12	●	1		
	12	24	Modular	R	GYHR3225P00-M25R	●	GYM25RA-F12	●	5	
			Modular	L	GYHL3225P00-M25L	●	GYM25LA-F12	●	5	
			Modular	R	GYHR3232P00-M25R	●	GYM25RA-F12	●	5	
			Modular	L	GYHL3232P00-M25L	●	GYM25LA-F12	●	5	
	18 *4	36	Modular	R	GYHR1616J00-M20R	●	GYM20RB-F18	●	4	
			Modular	L	GYHL1616J00-M20L	●	GYM20LB-F18	●	4	
		Monoblock	R	GYQR2020K00-F18	●	—	—	7		
		Monoblock	L	GYQL2020K00-F18	●	—	—	7		
20 *1	40 *2	Modular	R	GYHR2020K00-M20R	●	GYM20RB-F18	●	2		
		Modular	L	GYHL2020K00-M20L	●	GYM20LB-F18	●	2		
	Modular	R	GYHR2020K00-M25R	●	GYM25RA-F20	●	4			
	Modular	L	GYHL2020K00-M25L	●	GYM25LA-F20	●	4			
	Monoblock	R	GYQR2525M00-F20	●	—	—	7			
	Monoblock	L	GYQL2525M00-F20	●	—	—	7			
	Modular	R	GYHR2525M00-M25R	●	GYM25RA-F20	●	2			
	Modular	L	GYHL2525M00-M25L	●	GYM25LA-F20	●	2			
20 *1	40 *2	Modular	R	GYHR3225P00-M25R	●	GYM25RA-F20	●	6		
		Modular	L	GYHL3225P00-M25L	●	GYM25LA-F20	●	6		
		Modular	R	GYHR3232P00-M25R	●	GYM25RA-F20	●	6		
		Modular	L	GYHL3232P00-M25L	●	GYM25LA-F20	●	6		

*1 The maximum groove depth (CDX) varies according to the insert used. Please refer to the maximum groove depth (CDX) of inserts on pages F012—F015.

*2 The maximum cut off diameter (CUTDIA) varies according to the insert used.

The cut off diameter is double the maximum groove depth (CDX) of inserts on pages F012—F015.

*3 Dimensions shown are when the standard insert is used. If other insert geometries are used then LF, LH, LH2 and WF values may vary.

*4 The maximum groove depth (CDX) is limited by the workpiece diameter. For details, please refer to page F098.

● : Inventory maintained.

* Wrench : ① : Clamp Screw, ② : Blade Screw

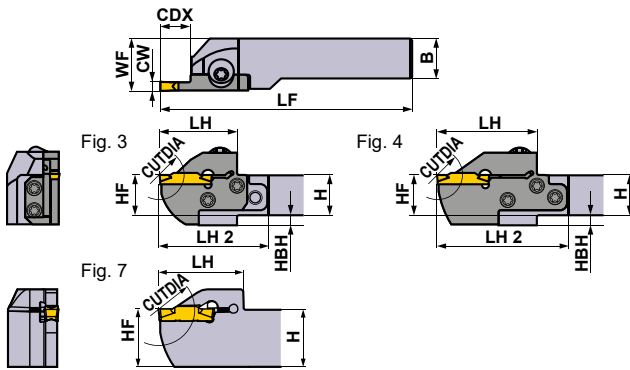

Right hand tool holder shown.

SPARE PARTS

Holder	Clamp Screw	Blade Screw 5 pcs.	Wrench *
GYQR/L	HSC05020 (Clamp Torque : 7.0N·m)	—	HKY40R
GYHR/L	GY06013M (Clamp Torque : 6.0N·m)	TS407 (Clamp Torque : 3.5N·m)	①TKY30R ②TKY15D
GYHR/L			TS55 (Clamp Torque : 5.0N·m)

Dimensions (mm) *3									Cutting Mode	
H	B	LF	LH	LH 2	HF	WF	HBH		Clockwise	Anticlockwise
16	16	104	28	44	16	20	4	R		
16	16	104	28	44	16	20	4			
20	20	125	36	—	20	20.3	—			
20	20	125	36	—	20	20.3	—			
20	20	119	28	43	20	23	—			
20	20	119	28	43	20	23	—			
20	20	117	31	52	20	26	5			
20	20	117	31	52	20	26	5			
25	25	150	36	—	25	25.3	—			
25	25	150	36	—	25	25.3	—			
25	25	142	31	49	25	28	—			
25	25	142	31	49	25	28	—			
32	25	162	31	49	32	28	—			
32	25	162	31	49	32	28	—			
32	32	162	31	49	32	35	—			
32	32	162	31	49	32	35	—			
16	16	110	34	50	16	20	4			
16	16	110	34	50	16	20	4			
20	20	125	34	49	20	23	—			
20	20	125	34	49	20	23	—			
20	20	125	39	60	20	26	5			
20	20	125	39	60	20	26	5			
25	25	150	39	57	25	28	—			
25	25	150	39	57	25	28	—			
32	25	170	39	57	32	28	—			
32	25	170	39	57	32	28	—			
32	32	170	39	57	32	35	—			
32	32	170	39	57	32	35	—			
16	16	116	40	56	16	20	4			
16	16	116	40	56	16	20	4			
20	20	125	39	—	20	20.25	—			
20	20	125	39	—	20	20.25	—			
20	20	131	40	55	20	23	—			
20	20	131	40	55	20	23	—			
20	20	131	45	66	20	26	5			
20	20	131	45	66	20	26	5			
25	25	150	41	—	25	25.25	—			
25	25	150	41	—	25	25.25	—			
25	25	156	45	63	25	28	—			
25	25	156	45	63	25	28	—			
32	25	176	45	63	32	28	—			
32	25	176	45	63	32	28	—			
32	32	176	45	63	32	35	—			
32	32	176	45	63	32	35	—			

Insert selection

Seat Size	Geometry name
F	GY-0239/0250/0274E-Breaker shown below

For grooving/cutting off breaker > F012, F013						
Seat Size	Breaker	GU	GS	GM	GL	GFGS
		(For gummy steel)	(Low)	(Medium)	(Aluminium alloy)	(Hardened steel)
F	CW	Neutral	Neutral	Neutral	Neutral	With hand
	3.00mm	●	●	●	●	●
	3.18mm	●	●	●	●	●

For multifunctional grooving breaker > F014, F015					
Seat Size	Breaker	MF	MS	MM	BM
		(Finish)	(Low)	(Medium)	(Copying, Recessing)
F	3.00mm				●
	RE 0.2	●	●	●	
	RE 0.4	●	●	●	
	RE 0.8			●	
	3.18mm				●
	RE 0.2	●			
	RE 0.4	●			
	3.24mm	●			

● : Standard insert with dimensions

IDENTIFICATION > F008, F009
 CUTTING CONDITIONS > F096
 CAUTION FOR USE > F100

GY SERIES (EXTERNAL)

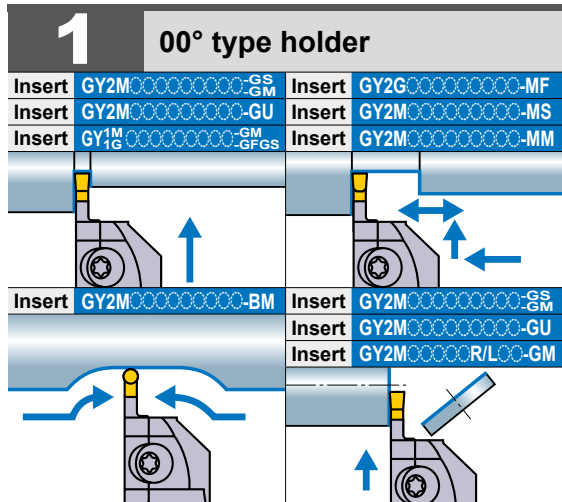

Note 1) For modular blades and modular holders, please order separately.
 Note 2) Please use right hand modular blade for right hand holder and left hand modular blade for left hand holder.

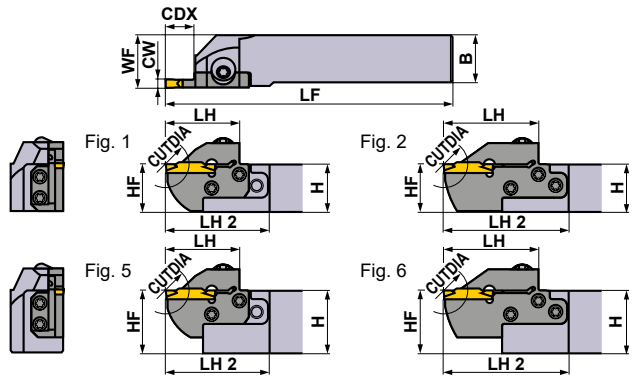

Right hand tool holder shown.

Seat Size	Dimensions (mm)			Type	Hand (R/L)	Order Number				Fig.
	CW	CDX	CUTDIA			Holder	Stock	Modular Blade	Stock	
G	4.00 4.24	8	16	Monoblock	R	GYQR2020K00-G08	●	—	—	7
					L	GYQL2020K00-G08	●	—	—	7
				Modular	R	GYHR2020K00-M25R	●	GYM25RA-G08	●	3
					L	GYHL2020K00-M25L	●	GYM25LA-G08	●	3
				Monoblock	R	GYQR2525M00-G08	●	—	—	7
					L	GYQL2525M00-G08	●	—	—	7
				Modular	R	GYHR2525M00-M25R	●	GYM25RA-G08	●	1
					L	GYHL2525M00-M25L	●	GYM25LA-G08	●	1
				Modular	R	GYHR3225P00-M25R	●	GYM25RA-G08	●	5
					L	GYHL3225P00-M25L	●	GYM25LA-G08	●	5
				Modular	R	GYHR3232P00-M25R	●	GYM25RA-G08	●	5
					L	GYHL3232P00-M25L	●	GYM25LA-G08	●	5
		12	24	Modular	R	GYHR1616J00-M20R	●	GYM20RA-G12	●	3
					L	GYHL1616J00-M20L	●	GYM20LA-G12	●	3
				Modular	R	GYHR2020K00-M20R	●	GYM20RA-G12	●	1
					L	GYHL2020K00-M20L	●	GYM20LA-G12	●	1
				Modular	R	GYHR2020K00-M25R	●	GYM25RA-G14	●	3
					L	GYHL2020K00-M25L	●	GYM25LA-G14	●	3
		14	28	Modular	R	GYHR2525M00-M25R	●	GYM25RA-G14	●	1
					L	GYHL2525M00-M25L	●	GYM25LA-G14	●	1
				Modular	R	GYHR3225P00-M25R	●	GYM25RA-G14	●	5
					L	GYHL3225P00-M25L	●	GYM25LA-G14	●	5
				Modular	R	GYHR3232P00-M25R	●	GYM25RA-G14	●	5
					L	GYHL3232P00-M25L	●	GYM25LA-G14	●	5
25 *1	50 *2	Monoblock	R	GYQR2020K00-G25	●	—	—	8		
			L	GYQL2020K00-G25	●	—	—	8		
		Modular	R	GYHR2020K00-M25R	●	GYM25RA-G25	●	4		
			L	GYHL2020K00-M25L	●	GYM25LA-G25	●	4		
		Monoblock	R	GYQR2525M00-G25	●	—	—	7		
			L	GYQL2525M00-G25	●	—	—	7		
		Modular	R	GYHR2525M00-M25R	●	GYM25RA-G25	●	2		
			L	GYHL2525M00-M25L	●	GYM25LA-G25	●	2		
		Modular	R	GYHR3225P00-M25R	●	GYM25RA-G25	●	6		
			L	GYHL3225P00-M25L	●	GYM25LA-G25	●	6		
Modular	R	GYHR3232P00-M25R	●	GYM25RA-G25	●	6				
	L	GYHL3232P00-M25L	●	GYM25LA-G25	●	6				

*1 The maximum groove depth (CDX) varies according to the insert used. Please refer to the maximum groove depth (CDX) of inserts on pages F012—F015.
 *2 The maximum cut off diameter (CUTDIA) varies according to the insert used.
 The cut off diameter is double the maximum groove depth (CDX) of inserts on pages F012—F015.
 *3 Dimensions shown are when the standard insert is used. If other insert geometries are used then LF, LH, LH2 and WF values may vary.

● : Inventory maintained.

* Wrench : ① : Clamp Screw, ② : Blade Screw

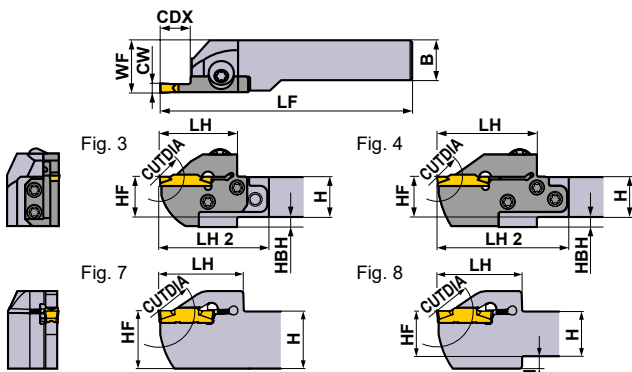

Right hand tool holder shown.

SPARE PARTS			
Holder		5 pcs.	① ②
	Clamp Screw	Blade Screw	Wrench *
GYQR/L	HSC05020 (Clamp Torque : 7.0N·m)	—	HKY40R
GYHR/L	GY06013M (Clamp Torque : 6.0N·m)	TS407 (Clamp Torque : 3.5N·m)	①TKY30R
-M20R/L			②TKY15D
GYHR/L	-M25R/L	TS55 (Clamp Torque : 5.0N·m)	①TKY30R
			②TKY25D

Dimensions (mm) *3								Cutting Mode	
H	B	LF	LH	LH 2	HF	WF	HBH	Clockwise	Anticlockwise
20	20	125	41	—	20	20.35	—	R	
20	20	125	41	—	20	20.35	—		
20	20	119	33	54	20	26	5		
20	20	119	33	54	20	26	5		
25	25	150	41	—	25	25.35	—		
25	25	150	41	—	25	25.35	—		
25	25	144	33	51	25	28	—		
25	25	144	33	51	25	28	—		
32	25	164	33	51	32	28	—		
32	25	164	33	51	32	28	—		
32	32	164	33	51	32	35	—		
32	32	164	33	51	32	35	—		
16	16	110	34	50	16	20	4	L	
16	16	110	34	50	16	20	4		
20	20	125	34	49	20	23	—		
20	20	125	34	49	20	23	—		
20	20	125	39	60	20	26	5		
20	20	125	39	60	20	26	5		
25	25	150	39	57	25	28	—		
25	25	150	39	57	25	28	—		
32	25	170	39	57	32	28	—		
32	25	170	39	57	32	28	—		
32	32	170	39	57	32	35	—		
32	32	170	39	57	32	35	—		
20	20	125	46	—	20	20.35	4		
20	20	125	46	—	20	20.35	4		
20	20	136	50	71	20	26	5		
20	20	136	50	71	20	26	5		
25	25	150	46	—	25	25.35	—		
25	25	150	46	—	25	25.35	—		
25	25	161	50	68	25	28	—		
25	25	161	50	68	25	28	—		
32	25	181	50	68	32	28	—		
32	25	181	50	68	32	28	—		
32	32	181	50	68	32	35	—		
32	32	181	50	68	32	35	—		

Insert selection

Seat Size	Geometry name
G	GY-0239/0250/0274E-Breaker shown below

For grooving/cutting off breaker > F012, F013						
Seat Size	Breaker	GU	GS	GM	05-GM	GFGS
		(For gummy steel)	(Low)	(Medium)	(Cutting off)	(Hardened steel)
	CW	Neutral	Neutral	Neutral	With hand	Neutral
G	4.00mm	●	●	●	●	●

For multifunctional grooving breaker > F014, F015					
Seat Size	Breaker	MF	MS	MM	BM
		(Finish)	(Low)	(Medium)	(Copying, Recessing)
	CW				Ball shape
	4.00mm	●	●	●	●
	RE 0.2	●	●	●	
	RE 0.4	●	●	●	
	RE 0.8	●	●	●	
G	4.24mm	●			

● : Standard insert with dimensions

GROOVING / CUTTING OFF

IDENTIFICATION > F008, F009
 CUTTING CONDITIONS > F096
 CAUTION FOR USE > F100

GY SERIES (EXTERNAL)

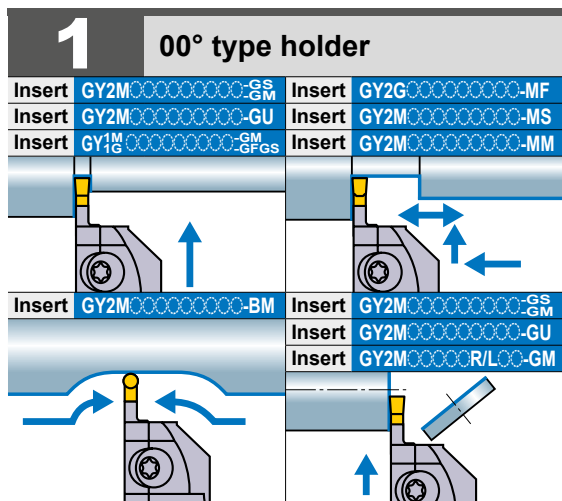

Note 1) For modular blades and modular holders, please order separately.
 Note 2) Please use right hand modular blade for right hand holder and left hand modular blade for left hand holder.

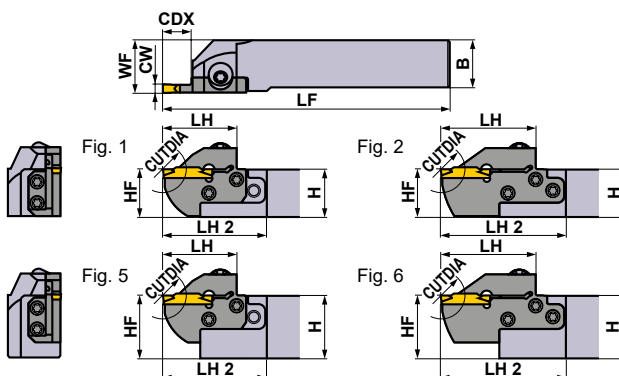

Right hand tool holder shown.

Seat Size	Dimensions (mm)			Type	Hand (R/L)	Order Number				Fig.
	CW	CDX	CUTDIA			Holder	Stock	Modular Blade	Stock	
H	4.75 5.00 5.24	8	16	Monoblock	R	GYQR2020K00-H08	●	—	—	7
					L	GYQL2020K00-H08	●	—	—	7
				Modular	R	GYHR2020K00-M25R	●	GYM25RA-H08	●	3
					L	GYHL2020K00-M25L	●	GYM25LA-H08	●	3
				Monoblock	R	GYQR2525M00-H08	●	—	—	7
					L	GYQL2525M00-H08	●	—	—	7
		Modular	R	GYHR2525M00-M25R	●	GYM25RA-H08	●	1		
			L	GYHL2525M00-M25L	●	GYM25LA-H08	●	1		
		Modular	R	GYHR3225P00-M25R	●	GYM25RA-H08	●	5		
			L	GYHL3225P00-M25L	●	GYM25LA-H08	●	5		
			R	GYHR3232P00-M25R	●	GYM25RA-H08	●	5		
			L	GYHL3232P00-M25L	●	GYM25LA-H08	●	5		
		12	24	Modular	R	GYHR1616J00-M20R	●	GYM20RA-H12	●	3
				L	GYHL1616J00-M20L	●	GYM20LA-H12	●	3	
	Modular			R	GYHR2020K00-M20R	●	GYM20RA-H12	●	1	
				L	GYHL2020K00-M20L	●	GYM20LA-H12	●	1	
	Modular			R	GYHR2020K00-M25R	●	GYM25RA-H14	●	3	
				L	GYHL2020K00-M25L	●	GYM25LA-H14	●	3	
		14	28	Modular	R	GYHR2525M00-M25R	●	GYM25RA-H14	●	1
				L	GYHL2525M00-M25L	●	GYM25LA-H14	●	1	
	Modular			R	GYHR3225P00-M25R	●	GYM25RA-H14	●	5	
				L	GYHL3225P00-M25L	●	GYM25LA-H14	●	5	
	Modular			R	GYHR3232P00-M25R	●	GYM25RA-H14	●	5	
				L	GYHL3232P00-M25L	●	GYM25LA-H14	●	5	
	25 *1	50 *2	Monoblock	R	GYQR2020K00-H25	●	—	—	8	
			L	GYQL2020K00-H25	●	—	—	8		
Modular			R	GYHR2020K00-M25R	●	GYM25RA-H25	●	4		
			L	GYHL2020K00-M25L	●	GYM25LA-H25	●	4		
Monoblock			R	GYQR2525M00-H25	●	—	—	7		
			L	GYQL2525M00-H25	●	—	—	7		
Modular			R	GYHR2525M00-M25R	●	GYM25RA-H25	●	2		
			L	GYHL2525M00-M25L	●	GYM25LA-H25	●	2		
Modular			R	GYHR3225P00-M25R	●	GYM25RA-H25	●	6		
			L	GYHL3225P00-M25L	●	GYM25LA-H25	●	6		
Modular			R	GYHR3232P00-M25R	●	GYM25RA-H25	●	6		
			L	GYHL3232P00-M25L	●	GYM25LA-H25	●	6		

*1 The maximum groove depth (CDX) varies according to the insert used. Please refer to the maximum groove depth (CDX) of inserts on pages F012—F015.

*2 The maximum cut off diameter (CUTDIA) varies according to the insert used.

The cut off diameter is double the maximum groove depth (CDX) of inserts on pages F012—F015.

*3 Dimensions shown are when the standard insert is used. If other insert geometries are used then LF, LH, LH2 and WF values may vary.

● : Inventory maintained.

GROOVING / CUTTING OFF

* Wrench : ① : Clamp Screw, ② : Blade Screw

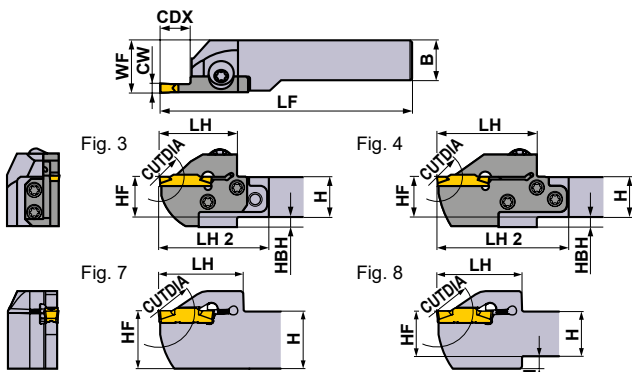

Right hand tool holder shown.

SPARE PARTS

Holder	Clamp Screw	Blade Screw 5 pcs.	Wrench *
GYQR/L	HSC05020 (Clamp Torque : 7.0N·m)	—	HKY40R
GYHR/L	GY06013M (Clamp Torque : 6.0N·m)	TS407 (Clamp Torque : 3.5N·m)	①TKY30R ②TKY15D
GYHR/L			TS55 (Clamp Torque : 5.0N·m)

Dimensions (mm) *3								Cutting Mode	
H	B	LF	LH	LH 2	HF	WF	HBH	Clockwise	Anticlockwise
20	20	125	41	—	20	20.35	—		
20	20	125	41	—	20	20.35	—		
20	20	119	33	54	20	26	5		
20	20	119	33	54	20	26	5		
25	25	150	41	—	25	25.35	—		
25	25	150	41	—	25	25.35	—		
25	25	144	33	51	25	28	—		
25	25	144	33	51	25	28	—		
32	25	164	33	51	32	28	—		
32	25	164	33	51	32	28	—		
32	32	164	33	51	32	35	—		
32	32	164	33	51	32	35	—		
16	16	110	34	50	16	20	4		
16	16	110	34	50	16	20	4		
20	20	125	34	49	20	23	—		
20	20	125	34	49	20	23	—		
20	20	125	39	60	20	26	5		
20	20	125	39	60	20	26	5		
25	25	150	39	57	25	28	—		
25	25	150	39	57	25	28	—		
32	25	170	39	57	32	28	—		
32	25	170	39	57	32	28	—		
32	32	170	39	57	32	35	—		
32	32	170	39	57	32	35	—		
20	20	125	46	—	20	20.35	4		
20	20	125	46	—	20	20.35	4		
20	20	136	50	71	20	26	5		
20	20	136	50	71	20	26	5		
25	25	150	46	—	25	25.35	—		
25	25	150	46	—	25	25.35	—		
25	25	161	50	68	25	28	—		
25	25	161	50	68	25	28	—		
32	25	181	50	68	32	28	—		
32	25	181	50	68	32	28	—		
32	32	181	50	68	32	35	—		
32	32	181	50	68	32	35	—		

Insert selection

Seat Size	Geometry name
H	GY000475/0500/0524H Breaker shown below

For grooving/cutting off breaker > F012, F013						
Seat Size	Breaker	GU	GS	GM	05-GM	GFGS
		(For gummy steel)	(Low)	(Medium)	(Cutting off)	(Hardened steel)
CW	4.75mm	●	●	●	●	●
	5.00mm	●	●	●	●	●
H	4.75mm	●	●	●	●	●
	5.00mm	●	●	●	●	●

For multifunctional grooving breaker > F014, F015					
Seat Size	Breaker	MF	MS	MM	BM
		(Finish)	(Low)	(Medium)	(Copying, Recessing)
CW	4.75mm				●
	RE 0.2	●			
	RE 0.4	●			
	RE 0.8	●			
	5.00mm				●
	RE 0.2	●			
H	RE 0.4	●	●	●	
	RE 0.8	●	●	●	
	5.24mm	●			

● : Standard insert with dimensions

IDENTIFICATION > F008, F009
 CUTTING CONDITIONS > F096
 CAUTION FOR USE > F100

GY SERIES (EXTERNAL)

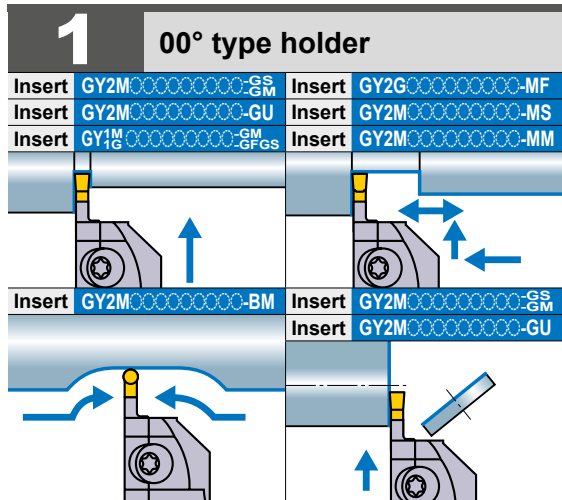

Note 1) For modular blades and modular holders, please order separately.
 Note 2) Please use right hand modular blade for right hand holder and left hand modular blade for left hand holder.

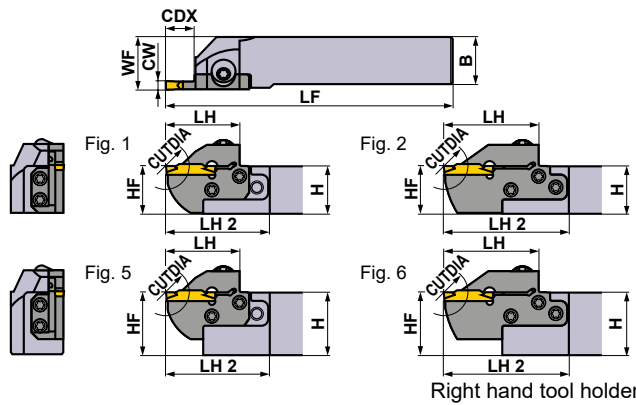

Right hand tool holder shown.

Seat Size	Dimensions (mm)			Type	Hand (R/L)	Order Number				Fig.
	CW	CDX	CUTCUTDIA			Holder	Stock	Modular Blade	Stock	
J	6.00 6.31 6.35	8	16	Monoblock	R	GYQR2020K00-J08	●	—	—	7
				Monoblock	L	GYQL2020K00-J08	●	—	—	7
				Modular	R	GYHR2020K00-M25R	●	GYM25RA-J08	●	3
				Modular	L	GYHL2020K00-M25L	●	GYM25LA-J08	●	3
				Monoblock	R	GYQR2525M00-J08	●	—	—	7
				Monoblock	L	GYQL2525M00-J08	●	—	—	7
		Modular	R	GYHR2525M00-M25R	●	GYM25RA-J08	●	1		
		Modular	L	GYHL2525M00-M25L	●	GYM25LA-J08	●	1		
		Modular	R	GYHR3225P00-M25R	●	GYM25RA-J08	●	5		
		Modular	L	GYHL3225P00-M25L	●	GYM25LA-J08	●	5		
		Modular	R	GYHR3232P00-M25R	●	GYM25RA-J08	●	5		
		Modular	L	GYHL3232P00-M25L	●	GYM25LA-J08	●	5		
	14	28	Modular	R	GYHR2020K00-M25R	●	GYM25RA-J14	●	3	
			Modular	L	GYHL2020K00-M25L	●	GYM25LA-J14	●	3	
			Modular	R	GYHR2525M00-M25R	●	GYM25RA-J14	●	1	
			Modular	L	GYHL2525M00-M25L	●	GYM25LA-J14	●	1	
			Modular	R	GYHR3225P00-M25R	●	GYM25RA-J14	●	5	
			Modular	L	GYHL3225P00-M25L	●	GYM25LA-J14	●	5	
	25 *1	50 *2	Monoblock	R	GYQR2020K00-J25	●	—	—	8	
			Monoblock	L	GYQL2020K00-J25	●	—	—	8	
			Modular	R	GYHR2020K00-M25R	●	GYM25RA-J25	●	4	
			Modular	L	GYHL2020K00-M25L	●	GYM25LA-J25	●	4	
			Monoblock	R	GYQR2525M00-J25	●	—	—	7	
			Monoblock	L	GYQL2525M00-J25	●	—	—	7	
Modular	R	GYHR2525M00-M25R	●	GYM25RA-J25	●	2				
Modular	L	GYHL2525M00-M25L	●	GYM25LA-J25	●	2				
Modular	R	GYHR3225P00-M25R	●	GYM25RA-J25	●	6				
Modular	L	GYHL3225P00-M25L	●	GYM25LA-J25	●	6				
Modular	R	GYHR3232P00-M25R	●	GYM25RA-J25	●	6				
Modular	L	GYHL3232P00-M25L	●	GYM25LA-J25	●	6				

*1 The maximum groove depth (CDX) varies according to the insert used. Please refer to the maximum groove depth (CDX) of inserts on pages F012—F015.
 *2 The maximum cut off diameter (CUTCUTDIA) varies according to the insert used.
 The cut off diameter is double the maximum groove depth (CDX) of inserts on pages F012—F015.
 *3 Dimensions shown are when the standard insert is used. If other insert geometries are used then LF, LH, LH2 and WF values may vary.

● : Inventory maintained.

GROOVING / CUTTING OFF

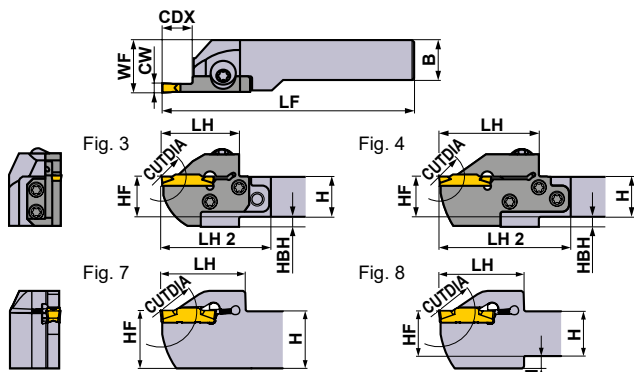

* Wrench : ① : Clamp Screw, ② : Blade Screw

SPARE PARTS			
Holder		5 pcs.	
	Clamp Screw	Blade Screw	Wrench *
GYQR/L	HSC05020 (Clamp Torque : 7.0N·m)	—	HKY40R
GYHR/L	GY06013M (Clamp Torque : 6.0N·m)	TS55 (Clamp Torque : 5.0N·m)	①TKY30R ②TKY25D

Right hand tool holder shown.

	Dimensions (mm) *3								Cutting Mode	
	H	B	LF	LH	LH 2	HF	WF	HBH	Clockwise	Anticlockwise
	20	20	125	41	—	20	20.35	—	R	
	20	20	125	41	—	20	20.35	—		
	20	20	119	33	54	20	26	5		
	20	20	119	33	54	20	26	5		
	25	25	150	41	—	25	25.35	—		
	25	25	150	41	—	25	25.35	—		
	25	25	144	33	51	25	28	—		
	25	25	144	33	51	25	28	—		
	32	25	164	33	51	32	28	—		
	32	25	164	33	51	32	28	—		
	32	32	164	33	51	32	35	—		
	32	32	164	33	51	32	35	—		
	20	20	125	39	60	20	26	5		
	20	20	125	39	60	20	26	5		
	25	25	150	39	57	25	28	—		
	25	25	150	39	57	25	28	—		
	32	25	170	39	57	32	28	—		
	32	25	170	39	57	32	28	—		
	32	32	170	39	57	32	35	—		
	32	32	170	39	57	32	35	—		
	20	20	125	46	—	20	20.35	4	L	
	20	20	125	46	—	20	20.35	4		
	20	20	136	50	71	20	26	5		
	20	20	136	50	71	20	26	5		
	25	25	150	46	—	25	25.35	—		
	25	25	150	46	—	25	25.35	—		
	25	25	161	50	68	25	28	—		
	25	25	161	50	68	25	28	—		
	32	25	181	50	68	32	28	—		
	32	25	181	50	68	32	28	—		
	32	32	181	50	68	32	35	—		
	32	32	181	50	68	32	35	—		

Insert selection

Seat Size	Geometry name
J	GY0600/0631/0635J — Breaker shown below

For grooving/cutting off breaker > F012, F013					
Seat Size	Breaker	GU	GS	GM	GFGS
		(For gummy steel)	(Low)	(Medium)	(Hardened steel)
J	6.00mm	●	●	●	●
	6.35mm	●	●	●	●

For multifunctional grooving breaker > F014, F015					
Seat Size	Breaker	MF	MS	MM	BM
		(Finish)	(Low)	(Medium)	(Copying, Recessing)
J	6.00mm				●
	RE 0.2	●			
	RE 0.4	●	●	●	
	RE 0.8	●	●	●	
	6.31mm	●			
	6.35mm				●

● : Standard insert with dimensions

IDENTIFICATION > F008, F009
 CUTTING CONDITIONS > F096
 CAUTION FOR USE > F100

GY SERIES (EXTERNAL)

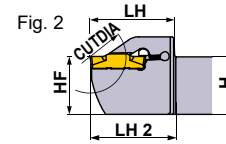
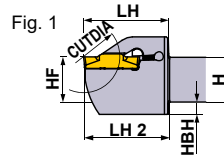
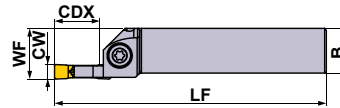
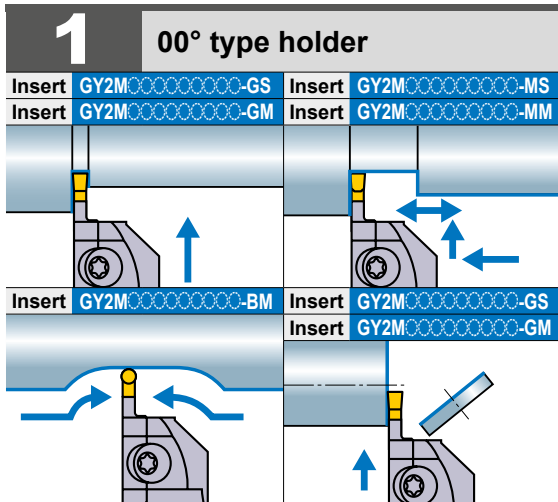

Right hand tool holder shown.

Seat Size	Dimensions (mm)			Type	Hand (R/L)	Order Number				Fig.
	CW	CDX	CUTDIA			Holder	Stock	Modular Blade	Stock	
K	8.00	25 *1	50 *2	Monoblock	R	GYPR2525M00-K25	●	—	—	1
				Monoblock	L	GYPL2525M00-K25	●	—	—	1
				Monoblock	R	GYPR3225P00-K25	●	—	—	2
				Monoblock	L	GYPL3225P00-K25	●	—	—	2
				Monoblock	R	GYPR3232P00-K25	●	—	—	3
				Monoblock	L	GYPL3232P00-K25	●	—	—	3

*1 The maximum groove depth (CDX) varies according to the insert used. Please refer to the maximum groove depth (CDX) of inserts on pages F012–F015.

*2 The maximum cut off diameter (CUTDIA) varies according to the insert used.

The cut off diameter is double the maximum groove depth (CDX) of inserts on pages F012–F015.

*3 Dimensions shown are when the standard insert is used. If other insert geometries are used then LF, LH, LH2 and WF values may vary.

● : Inventory maintained.

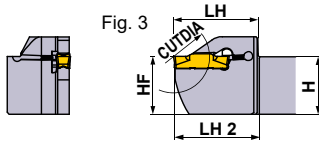
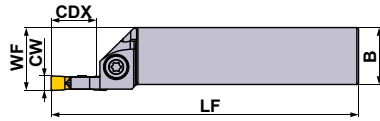

Right hand tool holder shown.

SPARE PARTS		
Holder		
	Clamp Screw	Wrench
GYPR/L○○○○○○○○00-K25		GY06013M (Clamp Torque : 6.0N·m)
		TKY30R

	Dimensions (mm) *3								Cutting Mode	
	H	B	LF	LH	LH 2	HF	WF	HBH	Clockwise	Anticlockwise
	25	25	150	47	48	25	28	7	R	
	25	25	150	47	48	25	28	7		
	32	25	170	47	48	32	28	—	L	
	32	25	170	47	48	32	28	—		
	32	32	170	47	48	32	35	—	R	
	32	32	170	47	48	32	35	—		
									L	

Insert selection

Seat Size	Geometry name
K	GY○○0800K○○○○-Breaker shown below

For grooving/cutting off breaker > F012, F013						
Seat Size	Breaker	GU	GS	GM	05-GM	GFGS
		(For gummy steel)	(Low)	(Medium)	(Cutting off)	(Hardened steel)
CW	Neutral	Neutral	Neutral	With hand	Neutral	
K	8.00mm		●	●		

For multifunctional grooving breaker > F014, F015					
Seat Size	Breaker	MF	MS	MM	BM
		(Finish)	(Low)	(Medium)	(Copying, Recessing)
CW	RE 0.8		●	●	●
K	RE 1.2		●	●	●

● : Standard insert with dimensions

GROOVING / CUTTING OFF

IDENTIFICATION > F008, F009
 CUTTING CONDITIONS > F096
 CAUTION FOR USE > F100

GY SERIES (EXTERNAL)

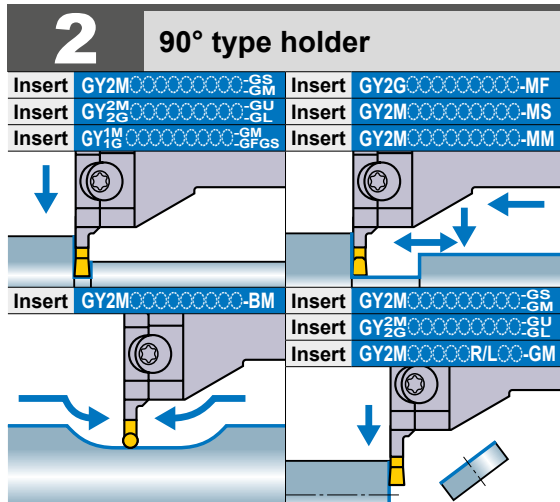

Note 1) For modular blades and modular holders, please order separately.
 Note 2) Please use left hand modular blade for right hand holder and right hand modular blade for left hand holder.

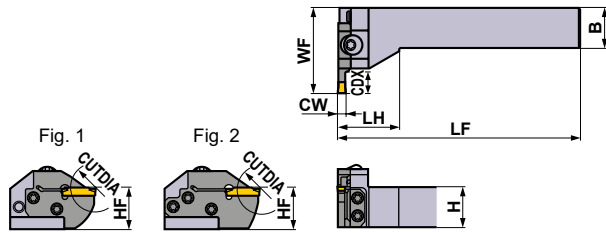

Right hand tool holder shown.

Seat Size	Dimensions (mm)			Type	Hand (R/L)	Order Number				Fig.
	CW	CDX	CUTDIA			Holder	Stock	Modular Blade	Stock	
D	2.00 2.24	6	12	Modular	R	GYHR2020K90-M20L	●	GYM20LA-D06	●	1
				L	GYHL2020K90-M20R	●	GYM20RA-D06	●	1	
		10	20	Modular	R	GYHR2525M90-M25L	●	GYM25LA-D06	●	1
				L	GYHL2525M90-M25R	●	GYM25RA-D06	●	1	
		12	24	Modular	R	GYHR2020K90-M20L	●	GYM20LA-D10	●	1
				L	GYHL2020K90-M20R	●	GYM20RA-D10	●	1	
18 *4	36	36	Modular	R	GYHR2525M90-M25L	●	GYM25LA-D12	●	1	
			L	GYHL2525M90-M25R	●	GYM25RA-D12	●	1		
E	2.39 2.50 2.74	6	12	Modular	R	GYHR2020K90-M20L	●	GYM20LA-E06	●	1
				L	GYHL2020K90-M20R	●	GYM20RA-E06	●	1	
		10	20	Modular	R	GYHR2525M90-M25L	●	GYM25LA-E06	●	1
				L	GYHL2525M90-M25R	●	GYM25RA-E06	●	1	
		12	24	Modular	R	GYHR2020K90-M20L	●	GYM20LA-E10	●	1
				L	GYHL2020K90-M20R	●	GYM20RA-E10	●	1	
18 *4	36	36	Modular	R	GYHR2525M90-M25L	●	GYM25LA-E12	●	1	
			L	GYHL2525M90-M25R	●	GYM25RA-E12	●	1		
20 *1	40 *2	40 *2	Modular	R	GYHR2020K90-M20L	●	GYM20LB-E18	●	2	
			L	GYHL2020K90-M20R	●	GYM20RB-E18	●	2		
20 *1	40 *2	40 *2	Modular	R	GYHR2525M90-M25L	●	GYM25LA-E20	●	2	
			L	GYHL2525M90-M25R	●	GYM25RA-E20	●	2		

*1 The maximum groove depth (CDX) varies according to the insert used. Please refer to the maximum groove depth (CDX) of inserts on pages F012–F015.

*2 The maximum cut off diameter (CUTDIA) varies according to the insert used.



The cut off diameter is double the maximum groove depth (CDX) of inserts on pages F012–F015.

*3 Dimensions shown are when the standard insert is used. If other insert geometries are used then LF, LH and WF values may vary.

*4 The maximum groove depth (CDX) is limited by the workpiece diameter. For details, please refer to page F098.

● : Inventory maintained.

* Wrench : ① : Clamp Screw, ② : Blade Screw

SPARE PARTS			
Holder		 5 pcs.	
	Clamp Screw	Blade Screw	Wrench *
GYHR2020K90-M20L	GY06013M (Clamp Torque : 6.0N·m)	TS407 (Clamp Torque : 3.5N·m)	①TKY30R
GYHL2020K90-M20R			②TKY15D
GYHR2525M90-M25L		TS55 (Clamp Torque : 5.0N·m)	①TKY30R
GYHL2525M90-M25R			②TKY25D

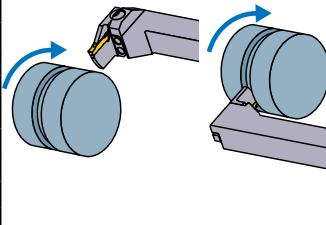
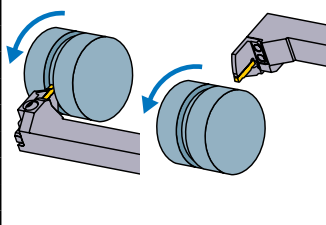
	Dimensions (mm) *3						Cutting Mode
	H	B	LF	LH	HF	WF	
	20	20	125	35	20	39	R 
	20	20	125	35	20	39	
	25	25	150	38	25	45	
	25	25	150	38	25	45	
	20	20	125	35	20	45	
	20	20	125	35	20	45	
	25	25	150	38	25	53	
	25	25	150	38	25	53	
	20	20	125	35	20	51	
	20	20	125	35	20	51	
	25	25	150	38	25	59	L 
	25	25	150	38	25	59	
	20	20	125	35	20	39	
	20	20	125	35	20	39	
	25	25	150	38	25	45	
	25	25	150	38	25	45	
	20	20	125	35	20	45	
	20	20	125	35	20	45	
	25	25	150	38	25	53	
	25	25	150	38	25	53	
	20	20	125	35	20	51	
	20	20	125	35	20	51	
	25	25	150	38	25	59	
	25	25	150	38	25	59	

Insert selection

Seat Size	Geometry name
D	GY○○○0200/0224D○○○○○-Breaker shown below
E	GY○○○0239/0250/0274E○○○○○-Breaker shown below

For grooving/cutting off breaker > F012, F013							
Seat Size	Breaker	GU	GS	GM	GL	05-GM	GFGS
		(For gummy steel)	(Low)	(Medium)	(Aluminium alloy)	(Cutting off)	(Hardened steel)
	CW	Neutral	Neutral	Neutral	Neutral	With hand	Neutral
D	2.00mm	●	●	●	●	●	●
E	2.39mm	●	●	●	●	●	●
	2.50mm	●	●	●	●	●	●

For multifunctional grooving breaker > F014, F015					
Seat Size	Breaker	MF	MS	MM	BM
		(Finish)	(Low)	(Medium)	(Copying, Recessing)
	CW				Ball shape
D	2.00mm	●	●	●	●
	2.24mm	●			
	2.39mm	●			
E	2.50mm	●	●	●	●
	2.74mm	●			

● : Standard insert with dimensions

F
GROOVING / CUTTING OFF

IDENTIFICATION > F008, F009
 CUTTING CONDITIONS > F096
 CAUTION FOR USE > F100

GY SERIES (EXTERNAL)

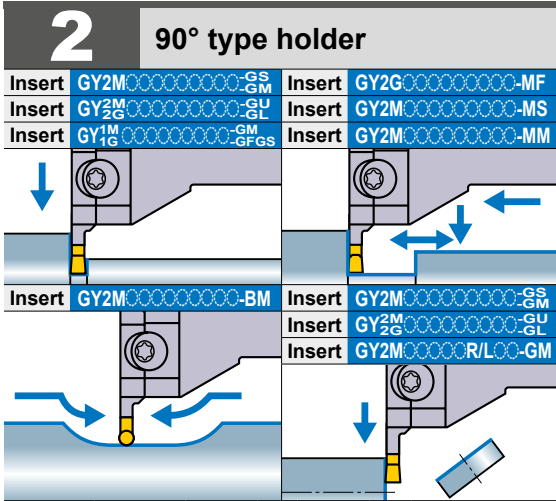

Note 1) For modular blades and modular holders, please order separately.
 Note 2) Please use left hand modular blade for right hand holder and right hand modular blade for left hand holder.

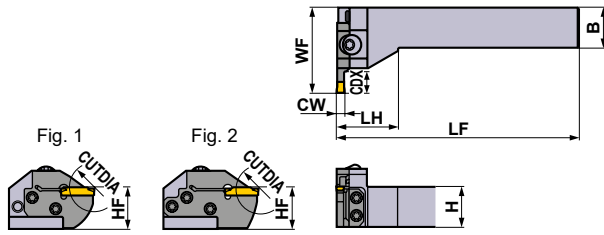

Right hand tool holder shown.

Seat Size	Dimensions (mm)			Type	Hand (R/L)	Order Number				Fig.
	CW	CDX	CUTDIA			Holder	Stock	Modular Blade	Stock	
F	3.00 3.18 3.24	6	12	Modular	R	GYHR2020K90-M20L	●	GYM20LA-F06	●	1
				Modular	L	GYHL2020K90-M20R	●	GYM20RA-F06	●	1
		10	20	Modular	R	GYHR2525M90-M25L	●	GYM25LA-F06	●	1
				Modular	L	GYHL2525M90-M25R	●	GYM25RA-F06	●	1
		12	24	Modular	R	GYHR2020K90-M20L	●	GYM20LA-F10	●	1
				Modular	L	GYHL2020K90-M20R	●	GYM20RA-F10	●	1
18 *4	36	Modular	R	GYHR2525M90-M25L	●	GYM25LA-F12	●	1		
		Modular	L	GYHL2525M90-M25R	●	GYM25RA-F12	●	1		
20 *1	40 *2	Modular	R	GYHR2020K90-M20L	●	GYM20LB-F18	●	2		
		Modular	L	GYHL2020K90-M20R	●	GYM20RB-F18	●	2		
G	4.00 4.24	8	16	Modular	R	GYHR2525M90-M25L	●	GYM25LA-G08	●	1
				Modular	L	GYHL2525M90-M25R	●	GYM25RA-G08	●	1
		12	24	Modular	R	GYHR2020K90-M20L	●	GYM20LA-G12	●	1
				Modular	L	GYHL2020K90-M20R	●	GYM20RA-G12	●	1
		14	28	Modular	R	GYHR2525M90-M25L	●	GYM25LA-G14	●	1
				Modular	L	GYHL2525M90-M25R	●	GYM25RA-G14	●	1
25 *1	50 *2	Modular	R	GYHR2525M90-M25L	●	GYM25LA-G25	●	2		
		Modular	L	GYHL2525M90-M25R	●	GYM25RA-G25	●	2		

*1 The maximum groove depth (CDX) varies according to the insert used. Please refer to the maximum groove depth (CDX) of inserts on pages F012–F015.

*2 The maximum cut off diameter (CUTDIA) varies according to the insert used.



The cut off diameter is double the maximum groove depth (CDX) of inserts on pages F012–F015.

*3 Dimensions shown are when the standard insert is used. If other insert geometries are used then LF, LH and WF values may vary.

*4 The maximum groove depth (CDX) is limited by the workpiece diameter. For details, please refer to page F098.

● : Inventory maintained.

* Wrench : ① : Clamp Screw, ② : Blade Screw

SPARE PARTS			
Holder		 5 pcs.	
	Clamp Screw	Blade Screw	Wrench *
GYHR2020K90-M20L	GY06013M (Clamp Torque : 6.0N·m)	TS407 (Clamp Torque : 3.5N·m)	①TKY30R
GYHL2020K90-M20R			②TKY15D
GYHR2525M90-M25L		TS55 (Clamp Torque : 5.0N·m)	①TKY30R
GYHL2525M90-M25R			②TKY25D

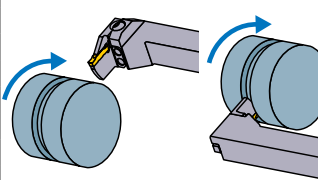
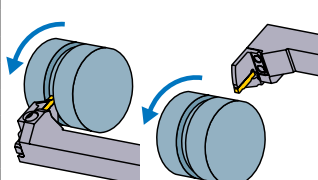
	Dimensions (mm) *3						Cutting Mode
	H	B	LF	LH	HF	WF	
	20	20	125	35	20	39	R 
	20	20	125	35	20	39	
	25	25	150	38	25	45	
	25	25	150	38	25	45	
	20	20	125	35	20	45	
	20	20	125	35	20	45	
	25	25	150	38	25	53	
	25	25	150	38	25	53	
	20	20	125	35	20	51	
	20	20	125	35	20	51	
	25	25	150	38	25	59	L 
	25	25	150	38	25	59	
	25	25	150	38	25	47	
	25	25	150	38	25	47	
	20	20	125	35	20	45	
	20	20	125	35	20	45	
	25	25	150	38	25	53	
	25	25	150	38	25	53	
	25	25	150	38	25	64	
	25	25	150	38	25	64	

Insert selection

Seat Size	Geometry name
F	GY○○○0300/0318/0324F○○○○○-Breaker shown below
G	GY○○○0400/0424G○○○○○-Breaker shown below

For grooving/cutting off breaker > F012, F013						
Seat Size	Breaker	GU	GS	GM	GL	GFGS
		(For gummy steel)	(Low)	(Medium)	(Aluminium alloy)	(Hardened steel)
	CW	Neutral	Neutral	Neutral	Neutral	With hand
F	3.00mm	●	●	●	●	●
	3.18mm	●	●	●	●	●
G	4.00mm	●	●	●	●	●

For multifunctional grooving breaker > F014, F015					
Seat Size	Breaker	MF	MS	MM	BM
		(Finish)	(Low)	(Medium)	(Copying, Recessing)
	CW				Ball shape
F	3.00mm				●
	RE 0.2	●	●	●	
	RE 0.4	●	●	●	
	RE 0.8			●	
	3.18mm				●
	RE 0.2	●			
G	3.24mm	●			
	4.00mm				●
	RE 0.2	●	●	●	
	RE 0.4	●	●	●	
	RE 0.8	●		●	
	4.24mm	●			

● : Standard insert with dimensions

F
GROOVING / CUTTING OFF

IDENTIFICATION > F008, F009
 CUTTING CONDITIONS > F096
 CAUTION FOR USE > F100

GY SERIES (EXTERNAL)

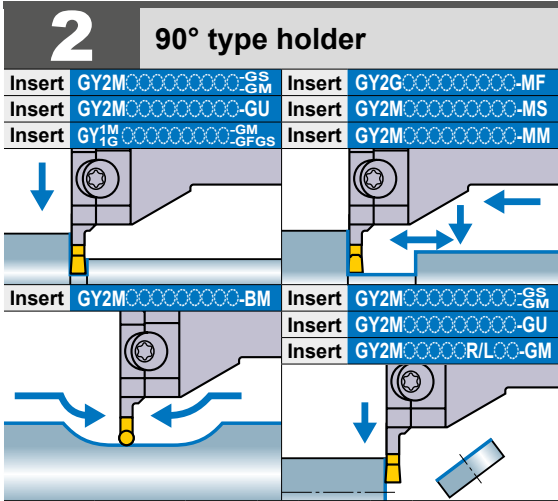

Note 1) For modular blades and modular holders, please order separately.
 Note 2) Please use left hand modular blade for right hand holder and right hand modular blade for left hand holder.

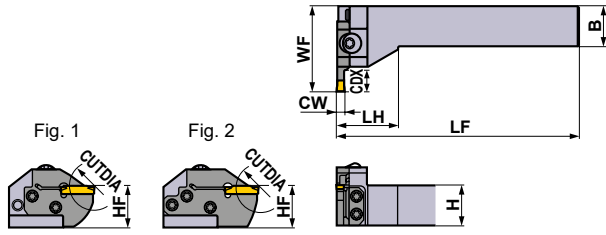

Right hand tool holder shown.

Seat Size	Dimensions (mm)			Type	Hand (R/L)	Order Number				Fig.	
	CW	CDX	CUTDIA			Holder	Stock	Modular Blade	Stock		
H	4.75 5.00 5.24	8	16	Modular	R L	GYHR2525M90-M25L GYHL2525M90-M25R	● ●	GYM25LA-H08 GYM25RA-H08	● ●	1 1	
		12	24	Modular	R L	GYHR2020K90-M20L GYHL2020K90-M20R	● ●	GYM20LA-H12 GYM20RA-H12	● ●	1 1	
		14	28	Modular	R L	GYHR2525M90-M25L GYHL2525M90-M25R	● ●	GYM25LA-H14 GYM25RA-H14	● ●	1 1	
		25 *1	50 *2	Modular	R L	GYHR2525M90-M25L GYHL2525M90-M25R	● ●	GYM25LA-H25 GYM25RA-H25	● ●	2 2	
J	6.00 6.31 6.35	8	16	Modular	R L	GYHR2525M90-M25L GYHL2525M90-M25R	● ●	GYM25LA-J08 GYM25RA-J08	● ●	1 1	
		14	28	Modular	R L	GYHR2525M90-M25L GYHL2525M90-M25R	● ●	GYM25LA-J14 GYM25RA-J14	● ●	1 1	
		25 *1	50 *2	Modular	R L	GYHR2525M90-M25L GYHL2525M90-M25R	● ●	GYM25LA-J25 GYM25RA-J25	● ●	2 2	



*1 The maximum groove depth (CDX) varies according to the insert used. Please refer to the maximum groove depth (CDX) of inserts on pages F012—F015.

*2 The maximum cut off diameter (CUTDIA) varies according to the insert used.
 The cut off diameter is double the maximum groove depth (CDX) of inserts on pages F012—F015.

*3 Dimensions shown are when the standard insert is used. If other insert geometries are used then LF, LH and WF values may vary.

● : Inventory maintained.

* Wrench : ① : Clamp Screw, ② : Blade Screw

SPARE PARTS			
Holder Number		 5 pcs.	
	Clamp Screw	Blade Screw	Wrench *
GYHR2020K90-M20L	GY06013M (Clamp Torque : 6.0N·m)	TS407 (Clamp Torque : 3.5N·m)	①TKY30R
GYHL2020K90-M20R			②TKY15D
GYHR2525M90-M25L		TS55 (Clamp Torque : 5.0N·m)	①TKY30R
GYHL2525M90-M25R			②TKY25D

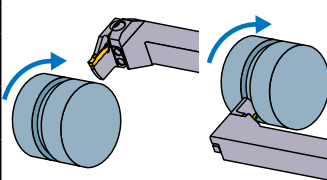
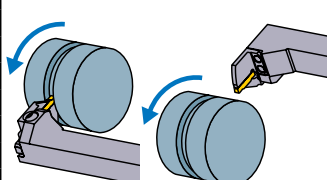
	Dimensions (mm) *3						Cutting Mode
	H	B	LF	LH	HF	WF	
	25	25	150	38	25	47	
	25	25	150	38	25	47	
	20	20	125	35	20	45	
	20	20	125	35	20	45	
	25	25	150	38	25	53	
	25	25	150	38	25	53	
	25	25	150	38	25	64	
	25	25	150	38	25	64	
							
	25	25	150	38	25	47	
	25	25	150	38	25	47	
	25	25	150	38	25	53	
	25	25	150	38	25	53	
	25	25	150	38	25	64	
	25	25	150	38	25	64	
	25	25	150	38	25	64	

Insert selection

Seat Size	Geometry name
H	GY○○0475/0500/0524H○○○○○Breaker shown below
J	GY○○0600/0631/0635J○○○○○Breaker shown below

For grooving/cutting off breaker> F012, F013						
Seat Size	Breaker	GU	GS	GM	05-GM	GFGS
		(For gummy steel)	(Low)	(Medium)	(Cutting off)	(Hardened steel)
	CW	Neutral	Neutral	Neutral	With hand	Neutral
H	4.75mm	●	●	●	●	●
	5.00mm	●	●	●	●	●
J	6.00mm	●	●	●	●	●
	6.35mm	●	●	●	●	●

For multifunctional grooving breaker> F014, F015					
Seat Size	Breaker	MF	MS	MM	BM
		(Finish)	(Low)	(Medium)	(Copying, Recessing)
	CW				Ball shape
H	4.75mm				●
	RE 0.2	●			
	RE 0.4	●			
	RE 0.8	●			
	5.00mm				●
	RE 0.2	●			
	RE 0.4	●	●	●	
	RE 0.8	●	●	●	
J	5.24mm	●			
	6.00mm				●
	RE 0.2	●			
	RE 0.4	●	●	●	
	RE 0.8	●	●	●	
	6.31mm	●			
	6.35mm				●
	RE 0.2	●			
RE 0.4	●				
RE 0.8	●				

● : Standard insert with dimensions

IDENTIFICATION > F008, F009
 CUTTING CONDITIONS > F096
 CAUTION FOR USE > F100

GY SERIES (FOR EXTERNAL RECESSING)

3

For 50° recessing holder

Note 1) For modular blades and modular holders, please order separately.

Note 2) Please use left hand modular blade for right hand holder and right hand modular blade for left hand holder.

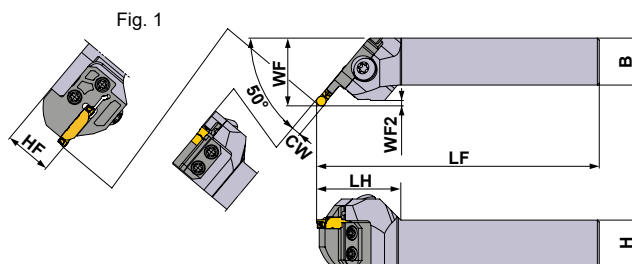
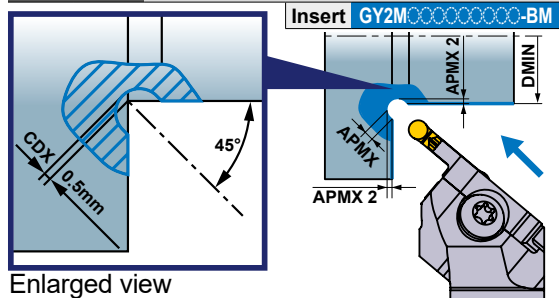

Right hand tool holder shown.



Seat Size	Dimensions (mm)					Type	Hand (R/L)	Order Number				Fig.
	CW	CDX	DMIN	APMX	APMX 2			Holder	Stock	Modular Blade	Stock	
D	2.00	0.5	30	1.5	0.646	Modular	R	GYHR2020K50-M20L	●	GYM20LC-D005	●	1
						Modular	L	GYHL2020K50-M20R	●	GYM20RC-D005	●	1
E	2.50			1.75	0.72	Modular	R	GYHR2525M50-M25L	●	GYM25LC-D005	●	1
						Modular	L	GYHL2525M50-M25R	●	GYM25RC-D005	●	1
F	3.00 3.18			2	0.793	Modular	R	GYHR2020K50-M20L	●	GYM20LC-E005	●	1
						Modular	L	GYHL2020K50-M20R	●	GYM20RC-E005	●	1
G	4.00			2.5	0.939	Modular	R	GYHR2525M50-M25L	●	GYM25LC-E005	●	1
						Modular	L	GYHL2525M50-M25R	●	GYM25RC-E005	●	1
H	4.75 5.00			2.88	1.049	Modular	R	GYHR2020K50-M20L	●	GYM20LC-F005	●	1
						Modular	L	GYHL2020K50-M20R	●	GYM20RC-F005	●	1
J	6.00 6.35	3.5	1.232	Modular	R	GYHR2525M50-M25L	●	GYM25LC-F005	●	1		
				Modular	L	GYHL2525M50-M25R	●	GYM25RC-F005	●	1		

*1 The blade for external grooving and face grooving cannot be used due to interference with the workpiece.

*2 Dimensions shown are when the standard insert is used. If other insert geometries are used then LF, LH, WF and WF2 values may vary.

● : Inventory maintained.

* Wrench : ① : Clamp Screw, ② : Blade Screw

SPARE PARTS			
Holder		 4 pcs.	
	Clamp Screw	Blade Screw	Wrench *
GYHR/L2020K50-M20R/L	GY06013M (Clamp Torque : 6.0N·m)	TS407 (Clamp Torque : 3.5N·m)	①TKY30R ②TKY25D
GYHR/L2525M50-M25R/L		TS55 (Clamp Torque : 5.0N·m)	①TKY30R ②TKY25D

	Dimensions (mm) *2						
	H	B	LF	LH	HF	WF	WF2
	20	20	125	40	20	32	1.6
	20	20	125	40	20	32	1.6
	25	25	150	45	25	35	1.6
	25	25	150	45	25	35	1.6
	20	20	125	40	20	32	1.8
	20	20	125	40	20	32	1.8
	25	25	150	45	25	35	1.8
	25	25	150	45	25	35	1.8
	20	20	125	40	20	32	2.0
	20	20	125	40	20	32	2.0
	25	25	150	45	25	35	2.0
	25	25	150	45	25	35	2.0
	20	20	125	40	20	32	2.4
	20	20	125	40	20	32	2.4
	25	25	150	45	25	35	2.4
	25	25	150	45	25	35	2.4
	20	20	125	40	20	33	2.8
	20	20	125	40	20	33	2.8
	25	25	150	45	25	36	2.8
	25	25	150	45	25	36	2.8
	25	25	150	44	25	36	3.4
	25	25	150	44	25	36	3.4

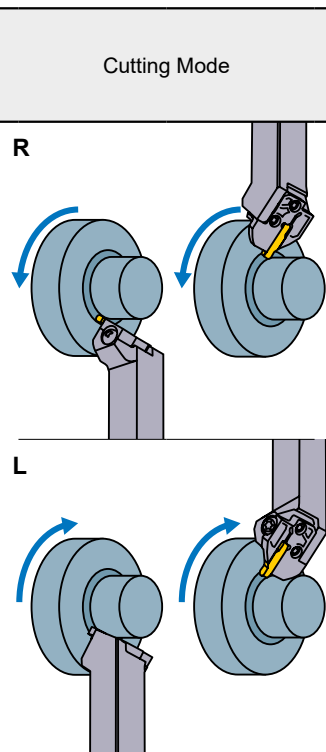

Insert selection

Geometry name

GY2M:○○○○○○○○○N-BM

For multifunctional grooving breaker > F015

Seat Size	Breaker CW	BM (Copying, Recessing)
		Ball shape
D	2.00mm	●
E	2.50mm	●
F	3.00mm	●
	3.18mm	●
G	4.00mm	●
H	4.75mm	●
	5.00mm	●
J	6.00mm	●
	6.35mm	●

● : Standard insert with dimensions

GROOVING / CUTTING OFF

IDENTIFICATION > F008, F009
 CUTTING CONDITIONS > F099
 CAUTION FOR USE > F099

GY SERIES (FACE GROOVING)

4

00° type holder

Note 1) For modular blades and modular holders, please order separately.

Note 2) Please use right hand modular blade for right hand holder and left hand modular blade for left hand holder.

Insert	GY2M ^{GS} _{GM}	Insert	GY2G ^{MF}
Insert	GY2M ^{GU}	Insert	GY2M ^{MS}
Insert	GY1 ^{GM} _{GFGS}	Insert	GY2M ^{MM}

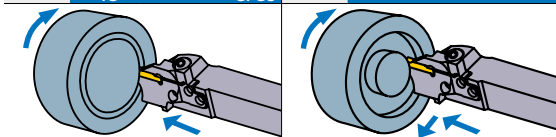

Insert GY2M^{BM}

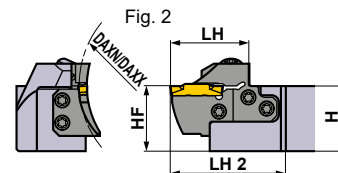
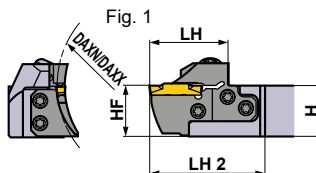
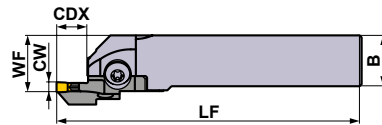
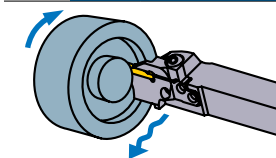

Right hand tool holder shown.

Seat Size	Dimensions (mm)				Type	Hand (R/L)	Order Number				Fig.
	CW	DAXN	DAXX	CDX			Holder	Stock	Modular Blade	Stock	
D	2.00	40	50	12	Modular	R	GYHR2020K00-M25R	●	GYM25RD-D12-040	●	3
					Modular	L	GYHL2020K00-M25L	●	GYM25LD-D12-040	●	3
					Modular	R	GYHR2525M00-M25R	●	GYM25RD-D12-040	●	1
					Modular	L	GYHL2525M00-M25L	●	GYM25LD-D12-040	●	1
		Modular	R	GYHR3225P00-M25R	●	GYM25RD-D12-040	●	2			
		Modular	L	GYHL3225P00-M25L	●	GYM25LD-D12-040	●	2			
		Modular	R	GYHR3232P00-M25R	●	GYM25RD-D12-040	●	2			
		Modular	L	GYHL3232P00-M25L	●	GYM25LD-D12-040	●	2			
		Modular	R	GYHR2020K00-M25R	●	GYM25RD-D12-050	●	3			
		Modular	L	GYHL2020K00-M25L	●	GYM25LD-D12-050	●	3			
		Modular	R	GYHR2525M00-M25R	●	GYM25RD-D12-050	●	1			
		Modular	L	GYHL2525M00-M25L	●	GYM25LD-D12-050	●	1			
	Modular	R	GYHR3225P00-M25R	●	GYM25RD-D12-050	●	2				
	Modular	L	GYHL3225P00-M25L	●	GYM25LD-D12-050	●	2				
	Modular	R	GYHR3232P00-M25R	●	GYM25RD-D12-050	●	2				
	Modular	L	GYHL3232P00-M25L	●	GYM25LD-D12-050	●	2				
	Modular	R	GYHR2020K00-M25R	●	GYM25RD-D12-060	●	3				
	Modular	L	GYHL2020K00-M25L	●	GYM25LD-D12-060	●	3				
	Modular	R	GYHR2525M00-M25R	●	GYM25RD-D12-060	●	1				
	Modular	L	GYHL2525M00-M25L	●	GYM25LD-D12-060	●	1				
Modular	R	GYHR3225P00-M25R	●	GYM25RD-D12-060	●	2					
Modular	L	GYHL3225P00-M25L	●	GYM25LD-D12-060	●	2					
Modular	R	GYHR3232P00-M25R	●	GYM25RD-D12-060	●	2					
Modular	L	GYHL3232P00-M25L	●	GYM25LD-D12-060	●	2					
Modular	R	GYHR2020K00-M25R	●	GYM25RD-D12-075	●	3					
Modular	L	GYHL2020K00-M25L	●	GYM25LD-D12-075	●	3					
Modular	R	GYHR2525M00-M25R	●	GYM25RD-D12-075	●	1					
Modular	L	GYHL2525M00-M25L	●	GYM25LD-D12-075	●	1					
Modular	R	GYHR3225P00-M25R	●	GYM25RD-D12-075	●	2					
Modular	L	GYHL3225P00-M25L	●	GYM25LD-D12-075	●	2					
Modular	R	GYHR3232P00-M25R	●	GYM25RD-D12-075	●	2					
Modular	L	GYHL3232P00-M25L	●	GYM25LD-D12-075	●	2					

*1 Dimensions shown are when standard insert is used. If other insert geometries are used then LF, LH, LH2, and WF values may vary.

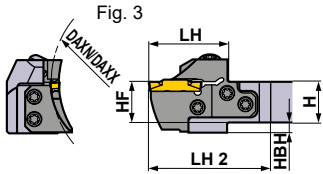
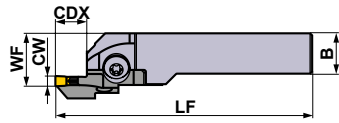

● : Inventory maintained.

* Wrench : ① : Clamp Screw, ② : Blade Screw



Right hand tool holder shown.

SPARE PARTS

Holder		 5 pcs.	
	Clamp Screw	Blade Screw	Wrench *
GYHR/L2020K00-M25R/L	GY06013M (Clamp Torque : 6.0N·m)	TS55 (Clamp Torque : 5.0N·m)	①TKY30R ②TKY25D
GYHR/L2525M00-M25R/L			
GYHR/L3225P00-M25R/L			
GYHR/L3232P00-M25R/L			

Dimensions (mm) *1									Cutting Mode
H	B	LF	LH	LH 2	HF	WF	HBH		
20	20	125	39	60	20	26	5	R	
20	20	125	39	60	20	26	5	R	
25	25	150	39	57	25	28	—	R	
25	25	150	39	57	25	28	—	R	
32	25	170	39	57	32	28	—	R	
32	25	170	39	57	32	28	—	R	
32	32	170	39	57	32	35	—	R	
32	32	170	39	57	32	35	—	R	
20	20	125	39	60	20	26	5	R	
20	20	125	39	60	20	26	5	R	
25	25	150	39	57	25	28	—	R	
25	25	150	39	57	25	28	—	R	
32	25	170	39	57	32	28	—	R	
32	25	170	39	57	32	28	—	R	
32	32	170	39	57	32	35	—	R	
32	32	170	39	57	32	35	—	R	
20	20	125	39	60	20	26	5	L	
20	20	125	39	60	20	26	5	L	
25	25	150	39	57	25	28	—	L	
25	25	150	39	57	25	28	—	L	
32	25	170	39	57	32	28	—	L	
32	25	170	39	57	32	28	—	L	
32	32	170	39	57	32	35	—	L	
32	32	170	39	57	32	35	—	L	
20	20	125	39	60	20	26	5	L	
20	20	125	39	60	20	26	5	L	
25	25	150	39	57	25	28	—	L	
25	25	150	39	57	25	28	—	L	
32	25	170	39	57	32	28	—	L	
32	25	170	39	57	32	28	—	L	
32	32	170	39	57	32	35	—	L	
32	32	170	39	57	32	35	—	L	

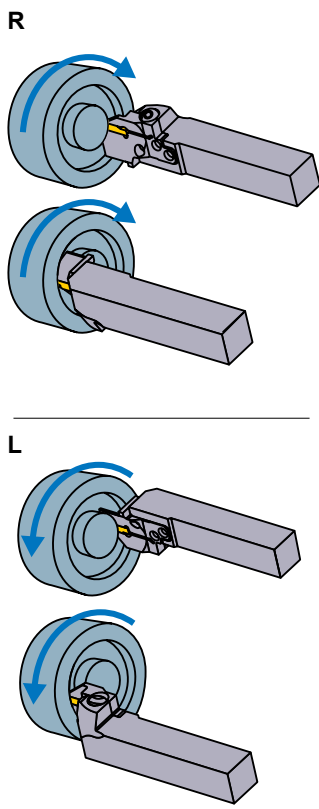

Insert selection

Seat Size	Geometry name
D	GY○○0200/0224D○○○—Breaker shown below

For grooving/cutting off breaker > F012, F013					
Seat Size	Breaker	GU (For gummy steel)	GS (Low)	GM (Medium)	GFGS (Hardened steel)
D	2.00mm	●	●	●	●

For multifunctional grooving breaker > F014, F015					
Seat Size	Breaker	MF (Finish)	MS (Low)	MM (Medium)	BM (Copying) Ball shape
D	2.00mm	●	●	●	●
	2.24mm	●	●	●	●

● : Standard insert with dimensions

IDENTIFICATION > F008, F009
CUTTING CONDITIONS > F104
CAUTION FOR USE > F106

GY SERIES (FACE GROOVING)

4

00° type holder

Note 1) For modular blades and modular holders, please order separately.
 Note 2) Please use right hand modular blade for right hand holder and left hand modular blade for left hand holder.

Insert	GY2M ^{GS} _{GM}	Insert	GY2G ^{MF}
Insert	GY2M ^{GU}	Insert	GY2M ^{MS}
Insert	GY1 ^{GM} _{GFGS}	Insert	GY2M ^{MM}

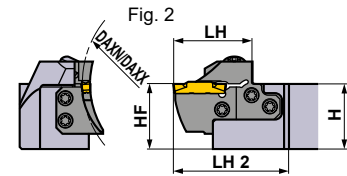
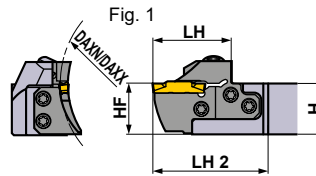
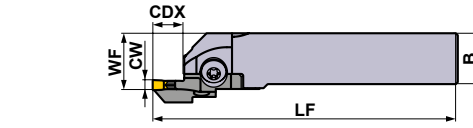
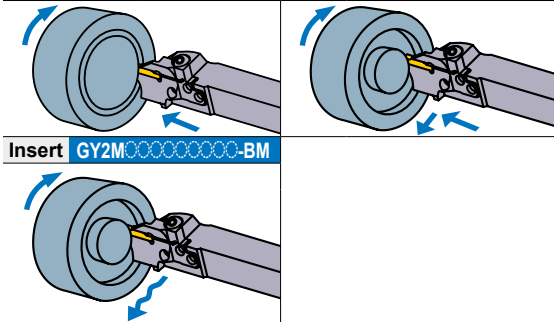

Right hand tool holder shown.

Seat Size	Dimensions (mm)				Type	Hand (R/L)	Order Number				Fig.
	CW	DAXN	DAXX	CDX			Holder	Stock	Modular Blade	Stock	
D	2.00 2.24	100	150	12	Modular	R	GYHR2020K00-M25R	●	GYM25RD-D12-100	●	3
					Modular	L	GYHL2020K00-M25L	●	GYM25LD-D12-100	●	3
					Modular	R	GYHR2525M00-M25R	●	GYM25RD-D12-100	●	1
					Modular	L	GYHL2525M00-M25L	●	GYM25LD-D12-100	●	1
		Modular	R	GYHR3225P00-M25R	●	GYM25RD-D12-100	●	2			
		Modular	L	GYHL3225P00-M25L	●	GYM25LD-D12-100	●	2			
		Modular	R	GYHR3232P00-M25R	●	GYM25RD-D12-100	●	2			
		Modular	L	GYHL3232P00-M25L	●	GYM25LD-D12-100	●	2			
	135	200	12	Modular	R	GYHR2020K00-M25R	●	GYM25RD-D12-135	●	3	
				Modular	L	GYHL2020K00-M25L	●	GYM25LD-D12-135	●	3	
				Modular	R	GYHR2525M00-M25R	●	GYM25RD-D12-135	●	1	
				Modular	L	GYHL2525M00-M25L	●	GYM25LD-D12-135	●	1	
	180	250	12	Modular	R	GYHR3225P00-M25R	●	GYM25RD-D12-135	●	2	
				Modular	L	GYHL3225P00-M25L	●	GYM25LD-D12-135	●	2	
				Modular	R	GYHR3232P00-M25R	●	GYM25RD-D12-135	●	2	
				Modular	L	GYHL3232P00-M25L	●	GYM25LD-D12-135	●	2	
180	250	12	Modular	R	GYHR2020K00-M25R	●	GYM25RD-D12-180	●	3		
			Modular	L	GYHL2020K00-M25L	●	GYM25LD-D12-180	●	3		
			Modular	R	GYHR2525M00-M25R	●	GYM25RD-D12-180	●	1		
			Modular	L	GYHL2525M00-M25L	●	GYM25LD-D12-180	●	1		
180	250	12	Modular	R	GYHR3225P00-M25R	●	GYM25RD-D12-180	●	2		
			Modular	L	GYHL3225P00-M25L	●	GYM25LD-D12-180	●	2		
			Modular	R	GYHR3232P00-M25R	●	GYM25RD-D12-180	●	2		
			Modular	L	GYHL3232P00-M25L	●	GYM25LD-D12-180	●	2		

*1 Dimensions shown are when standard insert is used. If other insert geometries are used then LF, LH, LH2, and WF values may vary.

● : Inventory maintained.

* Wrench : ① : Clamp Screw, ② : Blade Screw

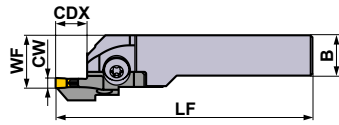
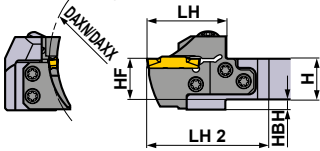





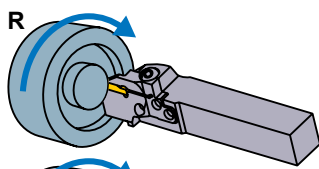
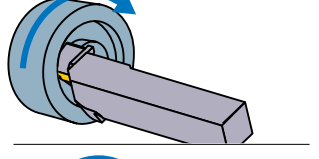
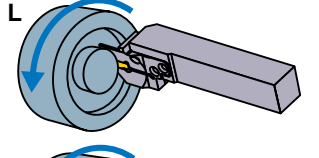
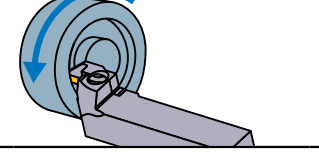

Fig. 3



Right hand tool holder shown.

SPARE PARTS

Holder		 5 pcs.	
	Clamp Screw	Blade Screw	Wrench *
GYHR/L2020K00-M25R/L	GY06013M (Clamp Torque : 6.0N·m)	TS55 (Clamp Torque : 5.0N·m)	①TKY30R ②TKY25D
GYHR/L2525M00-M25R/L			
GYHR/L3225P00-M25R/L			
GYHR/L3232P00-M25R/L			

	Dimensions (mm) *1								Cutting Mode
	H	B	LF	LH	LH 2	HF	WF	HBH	
	20	20	125	39	60	20	26	5	R
	20	20	125	39	60	20	26	5	
	25	25	150	39	57	25	28	—	
	25	25	150	39	57	25	28	—	
	32	25	170	39	57	32	28	—	
	32	25	170	39	57	32	28	—	
	32	32	170	39	57	32	35	—	L
	32	32	170	39	57	32	35	—	
	20	20	125	39	60	20	26	5	
	20	20	125	39	60	20	26	5	
	25	25	150	39	57	25	28	—	
	25	25	150	39	57	25	28	—	
	32	25	170	39	57	32	28	—	
	32	25	170	39	57	32	28	—	
	32	32	170	39	57	32	35	—	
	32	32	170	39	57	32	35	—	

Insert selection

Seat Size	Geometry name
D	GY○○0200/0224D○○○-Breaker shown below

For grooving/cutting off breaker > F012, F013					
Seat Size	Breaker	GU (For gummy steel)	GS (Low)	GM (Medium)	GFGS (Hardened steel)
D	2.00mm	●	●	●	●

For multifunctional grooving breaker > F014, F015					
Seat Size	Breaker	MF (Finish)	MS (Low)	MM (Medium)	BM (Copying) Ball shape
D	2.00mm	●	●	●	●
	2.24mm	●	●	●	●

● : Standard insert with dimensions

GROOVING / CUTTING OFF

IDENTIFICATION > F008, F009
 CUTTING CONDITIONS > F104
 CAUTION FOR USE > F106

GY SERIES (FACE GROOVING)

4

00° type holder

Note 1) For modular blades and modular holders, please order separately.
 Note 2) Please use right hand modular blade for right hand holder and left hand modular blade for left hand holder.

Insert	GY2M ^{GS} _{GM}	Insert	GY2G ^{MF}
Insert	GY2M ^{GU}	Insert	GY2M ^{MS}
Insert	GY1 ^{GM} _{GFGS}	Insert	GY2M ^{MM}

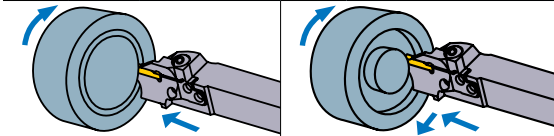

Insert GY2M^{BM}

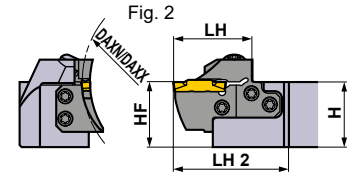
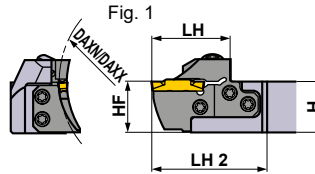
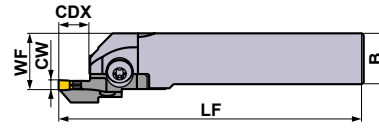
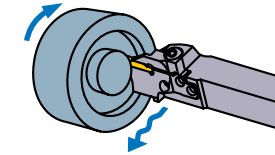

Right hand tool holder shown.

Seat Size	Dimensions (mm)				Type	Hand (R/L)	Order Number				Fig.
	CW	DAXN	DAXX	CDX			Holder	Stock	Modular Blade	Stock	
E	2.39 2.50 2.74	40	50	12	Modular	R	GYHR2020K00-M25R	●	GYM25RD-E12-040	●	3
					Modular	L	GYHL2020K00-M25L	●	GYM25LD-E12-040	●	3
					Modular	R	GYHR2525M00-M25R	●	GYM25RD-E12-040	●	1
					Modular	L	GYHL2525M00-M25L	●	GYM25LD-E12-040	●	1
		Modular	R	GYHR3225P00-M25R	●	GYM25RD-E12-040	●	2			
		Modular	L	GYHL3225P00-M25L	●	GYM25LD-E12-040	●	2			
		Modular	R	GYHR3232P00-M25R	●	GYM25RD-E12-040	●	2			
		Modular	L	GYHL3232P00-M25L	●	GYM25LD-E12-040	●	2			
	50	60	12	Modular	R	GYHR2020K00-M25R	●	GYM25RD-E12-050	●	3	
				Modular	L	GYHL2020K00-M25L	●	GYM25LD-E12-050	●	3	
				Modular	R	GYHR2525M00-M25R	●	GYM25RD-E12-050	●	1	
				Modular	L	GYHL2525M00-M25L	●	GYM25LD-E12-050	●	1	
	60	75	12	Modular	R	GYHR3225P00-M25R	●	GYM25RD-E12-050	●	2	
				Modular	L	GYHL3225P00-M25L	●	GYM25LD-E12-050	●	2	
				Modular	R	GYHR3232P00-M25R	●	GYM25RD-E12-050	●	2	
				Modular	L	GYHL3232P00-M25L	●	GYM25LD-E12-050	●	2	
	75	100	12	Modular	R	GYHR2020K00-M25R	●	GYM25RD-E12-060	●	3	
				Modular	L	GYHL2020K00-M25L	●	GYM25LD-E12-060	●	3	
				Modular	R	GYHR2525M00-M25R	●	GYM25RD-E12-060	●	1	
				Modular	L	GYHL2525M00-M25L	●	GYM25LD-E12-060	●	1	
Modular		R	GYHR3225P00-M25R	●	GYM25RD-E12-060	●	2				
Modular		L	GYHL3225P00-M25L	●	GYM25LD-E12-060	●	2				
Modular		R	GYHR3232P00-M25R	●	GYM25RD-E12-060	●	2				
Modular		L	GYHL3232P00-M25L	●	GYM25LD-E12-060	●	2				
75	100	12	Modular	R	GYHR2020K00-M25R	●	GYM25RD-E12-075	●	3		
			Modular	L	GYHL2020K00-M25L	●	GYM25LD-E12-075	●	3		
			Modular	R	GYHR2525M00-M25R	●	GYM25RD-E12-075	●	1		
			Modular	L	GYHL2525M00-M25L	●	GYM25LD-E12-075	●	1		
Modular	R	GYHR3225P00-M25R	●	GYM25RD-E12-075	●	2					
Modular	L	GYHL3225P00-M25L	●	GYM25LD-E12-075	●	2					
Modular	R	GYHR3232P00-M25R	●	GYM25RD-E12-075	●	2					
Modular	L	GYHL3232P00-M25L	●	GYM25LD-E12-075	●	2					

*1 Dimensions shown are when standard insert is used. If other insert geometries are used then LF, LH, LH2, and WF values may vary.

● : Inventory maintained.

* Wrench : ① : Clamp Screw, ② : Blade Screw

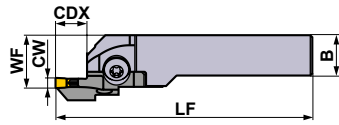
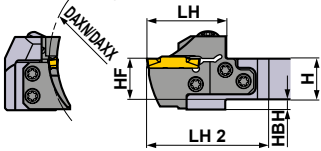





Fig. 3



Right hand tool holder shown.

SPARE PARTS

Holder Number		 5 pcs.	
	Clamp Screw	Blade Screw	Wrench *
GYHR/L2020K00-M25R/L	GY06013M (Clamp Torque : 6.0N·m)	TS55 (Clamp Torque : 5.0N·m)	①TKY30R ②TKY25D
GYHR/L2525M00-M25R/L			
GYHR/L3225P00-M25R/L			
GYHR/L3232P00-M25R/L			

Dimensions (mm) *1									Cutting Mode
H	B	LF	LH	LH 2	HF	WF	HBH		
20	20	125	39	60	20	26	5	R	
20	20	125	39	60	20	26	5		
25	25	150	39	57	25	28	—		
25	25	150	39	57	25	28	—		
32	25	170	39	57	32	28	—		
32	25	170	39	57	32	28	—		
32	32	170	39	57	32	35	—		
32	32	170	39	57	32	35	—		
20	20	125	39	60	20	26	5		
20	20	125	39	60	20	26	5		
25	25	150	39	57	25	28	—		
25	25	150	39	57	25	28	—		
32	25	170	39	57	32	28	—		
32	25	170	39	57	32	28	—		
32	32	170	39	57	32	35	—		
32	32	170	39	57	32	35	—		
20	20	125	39	60	20	26	5		
20	20	125	39	60	20	26	5		
25	25	150	39	57	25	28	—		
25	25	150	39	57	25	28	—		
32	25	170	39	57	32	28	—		
32	25	170	39	57	32	28	—		
32	32	170	39	57	32	35	—		
32	32	170	39	57	32	35	—		
20	20	125	39	60	20	26	5		
20	20	125	39	60	20	26	5		
25	25	150	39	57	25	28	—		
25	25	150	39	57	25	28	—		
32	25	170	39	57	32	28	—		
32	25	170	39	57	32	28	—		
32	32	170	39	57	32	35	—		
32	32	170	39	57	32	35	—		

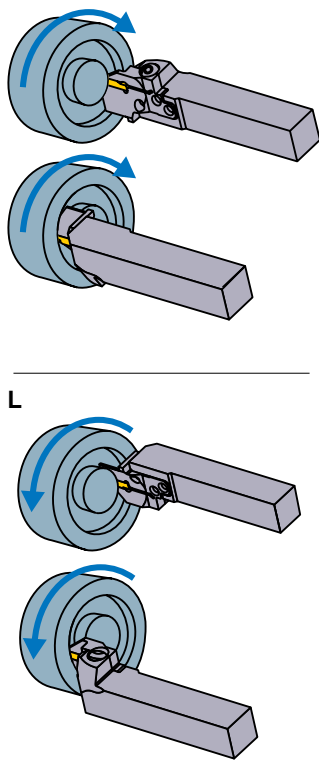

Insert selection

Seat Size	Geometry name
E	GY○○0239/0250/0274E○○○○○Breaker shown below

For grooving/cutting off breaker > F012, F013					
Seat Size	Breaker	GU	GS	GM	GFGS
		(For gummy steel)	(Low)	(Medium)	(Hardened steel)
E	2.39mm	●	●	●	●
	2.50mm	●	●	●	●

For multifunctional grooving breaker > F014, F015					
Seat Size	Breaker	MF	MS	MM	BM
		(Finish)	(Low)	(Medium)	(Copying)
E	2.39mm	●			
	2.50mm	●	●	●	●
	2.74mm	●			

● : Standard insert with dimensions

IDENTIFICATION > F008, F009
 CUTTING CONDITIONS > F104
 CAUTION FOR USE > F106

GY SERIES (FACE GROOVING)

4

00° type holder

Note 1) For modular blades and modular holders, please order separately.

Note 2) Please use right hand modular blade for right hand holder and left hand modular blade for left hand holder.

Insert	GY2M ^{GS} _{GM}	Insert	GY2G ^{MF}
Insert	GY2M ^{GU}	Insert	GY2M ^{MS}
Insert	GY1 ^{GM} _{GFGS}	Insert	GY2M ^{MM}

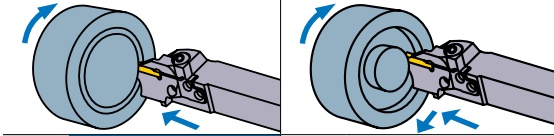

Insert GY2M^{BM}

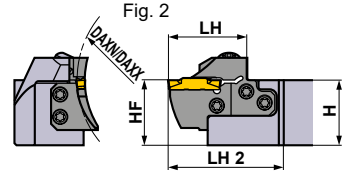
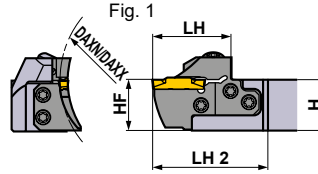
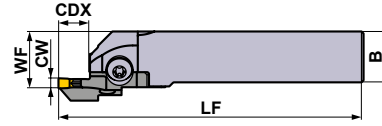
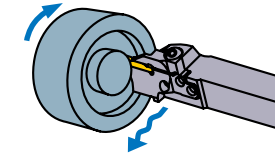

Right hand tool holder shown.

Seat Size	Dimensions (mm)				Type	Hand (R/L)	Order Number				Fig.
	CW	DAXN	DAXX	CDX			Holder	Stock	Modular Blade	Stock	
E	2.39 2.50 2.74	100	150	12	Modular	R	GYHR2020K00-M25R	●	GYM25RD-E12-100	●	3
					Modular	L	GYHL2020K00-M25L	●	GYM25LD-E12-100	●	3
					Modular	R	GYHR2525M00-M25R	●	GYM25RD-E12-100	●	1
					Modular	L	GYHL2525M00-M25L	●	GYM25LD-E12-100	●	1
		Modular	R	GYHR3225P00-M25R	●	GYM25RD-E12-100	●	2			
		Modular	L	GYHL3225P00-M25L	●	GYM25LD-E12-100	●	2			
		Modular	R	GYHR3232P00-M25R	●	GYM25RD-E12-100	●	2			
		Modular	L	GYHL3232P00-M25L	●	GYM25LD-E12-100	●	2			
	135	200	12	Modular	R	GYHR2020K00-M25R	●	GYM25RD-E12-135	●	3	
				Modular	L	GYHL2020K00-M25L	●	GYM25LD-E12-135	●	3	
				Modular	R	GYHR2525M00-M25R	●	GYM25RD-E12-135	●	1	
				Modular	L	GYHL2525M00-M25L	●	GYM25LD-E12-135	●	1	
	Modular	R	GYHR3225P00-M25R	●	GYM25RD-E12-135	●	2				
	Modular	L	GYHL3225P00-M25L	●	GYM25LD-E12-135	●	2				
	Modular	R	GYHR3232P00-M25R	●	GYM25RD-E12-135	●	2				
	Modular	L	GYHL3232P00-M25L	●	GYM25LD-E12-135	●	2				
180	250	12	Modular	R	GYHR2020K00-M25R	●	GYM25RD-E12-180	●	3		
			Modular	L	GYHL2020K00-M25L	●	GYM25LD-E12-180	●	3		
			Modular	R	GYHR2525M00-M25R	●	GYM25RD-E12-180	●	1		
			Modular	L	GYHL2525M00-M25L	●	GYM25LD-E12-180	●	1		
Modular	R	GYHR3225P00-M25R	●	GYM25RD-E12-180	●	2					
Modular	L	GYHL3225P00-M25L	●	GYM25LD-E12-180	●	2					
Modular	R	GYHR3232P00-M25R	●	GYM25RD-E12-180	●	2					
Modular	L	GYHL3232P00-M25L	●	GYM25LD-E12-180	●	2					

*1 Dimensions shown are when standard insert is used. If other insert geometries are used then LF, LH, LH2, and WF values may vary.

● : Inventory maintained.

* Wrench : ① : Clamp Screw, ② : Blade Screw

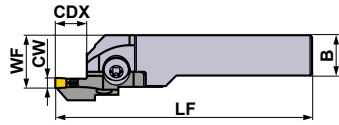
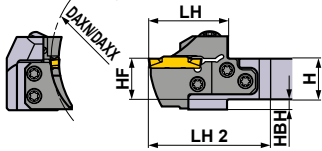





Fig. 3



Right hand tool holder shown.

SPARE PARTS

Holder		 5 pcs.	
	Clamp Screw	Blade Screw	Wrench *
GYHR/L2020K00-M25R/L	GY06013M (Clamp Torque : 6.0N·m)	TS55 (Clamp Torque : 5.0N·m)	①TKY30R ②TKY25D
GYHR/L2525M00-M25R/L			
GYHR/L3225P00-M25R/L			
GYHR/L3232P00-M25R/L			

	Dimensions (mm) *1								Cutting Mode
	H	B	LF	LH	LH 2	HF	WF	HBH	
	20	20	125	39	60	20	26	5	R
	20	20	125	39	60	20	26	5	
	25	25	150	39	57	25	28	—	R
	25	25	150	39	57	25	28	—	
	32	25	170	39	57	32	28	—	R
	32	25	170	39	57	32	28	—	
	32	32	170	39	57	32	35	—	R
	32	32	170	39	57	32	35	—	
	20	20	125	39	60	20	26	5	L
	20	20	125	39	60	20	26	5	
	25	25	150	39	57	25	28	—	L
	25	25	150	39	57	25	28	—	
	32	25	170	39	57	32	28	—	L
	32	25	170	39	57	32	28	—	
	32	32	170	39	57	32	35	—	L
	32	32	170	39	57	32	35	—	
	20	20	125	39	60	20	26	5	L
	20	20	125	39	60	20	26	5	
	25	25	150	39	57	25	28	—	L
	25	25	150	39	57	25	28	—	
	32	25	170	39	57	32	28	—	L
	32	25	170	39	57	32	28	—	
	32	32	170	39	57	32	35	—	L
	32	32	170	39	57	32	35	—	

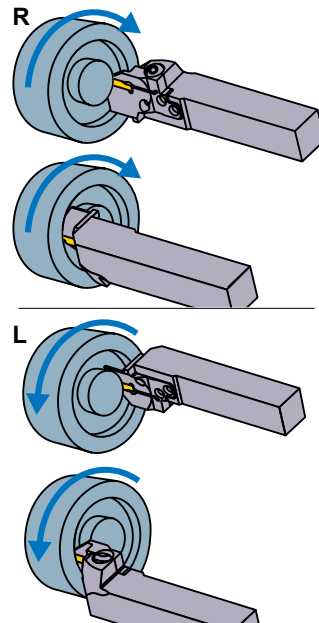

Insert selection

Seat Size	Geometry name
E	GY○○0239/0250/0274E○○○○○Breaker shown below

For grooving/cutting off breaker > F012, F013					
Seat Size	Breaker	GU	GS	GM	GFGS
		(For gummy steel)	(Low)	(Medium)	(Hardened steel)
E	2.39mm	●	●	●	●
	2.50mm	●	●	●	●

For multifunctional grooving breaker > F014, F015					
Seat Size	Breaker	MF	MS	MM	BM
		(Finish)	(Low)	(Medium)	(Copying)
E	2.39mm	●			
	2.50mm	●	●	●	●
	2.74mm	●			

● : Standard insert with dimensions

GROOVING / CUTTING OFF

IDENTIFICATION > F008, F009
 CUTTING CONDITIONS > F104
 CAUTION FOR USE > F106

GY SERIES (FACE GROOVING)

4

00° type holder

Note 1) For modular blades and modular holders, please order separately.

Note 2) Please use right hand modular blade for right hand holder and left hand modular blade for left hand holder.

Insert	GY2M ^{GS} _{GM}	Insert	GY2G ^{MF}
Insert	GY2M ^{GU}	Insert	GY2M ^{MS}
Insert	GY1 ^{GM} _{GFGS}	Insert	GY2M ^{MM}

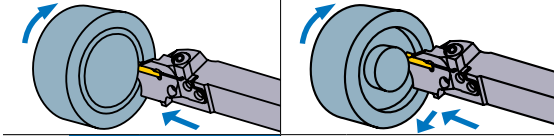

Insert GY2M^{BM}

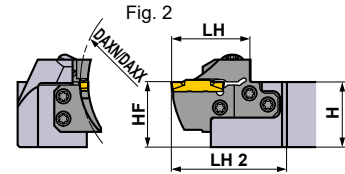
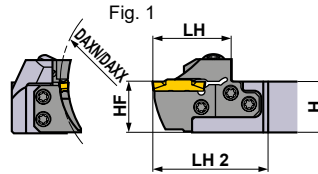
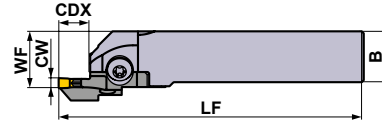
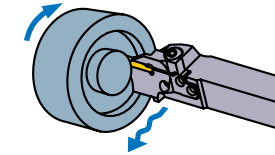

Right hand tool holder shown.

Seat Size	Dimensions (mm)				Type	Hand (R/L)	Order Number				Fig.
	CW	DAXN	DAXX	CDX			Holder	Stock	Modular Blade	Stock	
F	3.00 3.18 3.24	35	40	12	Modular	R	GYHR2020K00-M25R	●	GYM25RD-F12-035	●	3
					Modular	L	GYHL2020K00-M25L	●	GYM25LD-F12-035	●	3
					Modular	R	GYHR2525M00-M25R	●	GYM25RD-F12-035	●	1
					Modular	L	GYHL2525M00-M25L	●	GYM25LD-F12-035	●	1
		Modular	R	GYHR3225P00-M25R	●	GYM25RD-F12-035	●	2			
		Modular	L	GYHL3225P00-M25L	●	GYM25LD-F12-035	●	2			
		Modular	R	GYHR3232P00-M25R	●	GYM25RD-F12-035	●	2			
		Modular	L	GYHL3232P00-M25L	●	GYM25LD-F12-035	●	2			
	50	40	50	12	Modular	R	GYHR2020K00-M25R	●	GYM25RD-F12-040	●	3
					Modular	L	GYHL2020K00-M25L	●	GYM25LD-F12-040	●	3
					Modular	R	GYHR2525M00-M25R	●	GYM25RD-F12-040	●	1
					Modular	L	GYHL2525M00-M25L	●	GYM25LD-F12-040	●	1
		Modular	R	GYHR3225P00-M25R	●	GYM25RD-F12-040	●	2			
		Modular	L	GYHL3225P00-M25L	●	GYM25LD-F12-040	●	2			
		Modular	R	GYHR3232P00-M25R	●	GYM25RD-F12-040	●	2			
		Modular	L	GYHL3232P00-M25L	●	GYM25LD-F12-040	●	2			
60	50	60	12	Modular	R	GYHR2020K00-M25R	●	GYM25RD-F12-050	●	3	
				Modular	L	GYHL2020K00-M25L	●	GYM25LD-F12-050	●	3	
				Modular	R	GYHR2525M00-M25R	●	GYM25RD-F12-050	●	1	
				Modular	L	GYHL2525M00-M25L	●	GYM25LD-F12-050	●	1	
Modular	R	GYHR3225P00-M25R	●	GYM25RD-F12-050	●	2					
Modular	L	GYHL3225P00-M25L	●	GYM25LD-F12-050	●	2					
Modular	R	GYHR3232P00-M25R	●	GYM25RD-F12-050	●	2					
Modular	L	GYHL3232P00-M25L	●	GYM25LD-F12-050	●	2					

*1 Dimensions shown are when standard insert is used. If other insert geometries are used then LF, LH, LH2, and WF values may vary.

● : Inventory maintained.

★ Wrench : ① : Clamp Screw, ② : Blade Screw

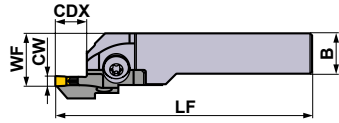
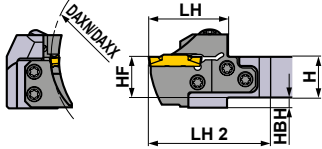





Fig. 3



Right hand tool holder shown.

SPARE PARTS

Holder		 5 pcs.	
	Clamp Screw	Blade Screw	Wrench ★
GYHR/L2020K00-M25R/L	GY06013M (Clamp Torque : 6.0N·m)	TS55 (Clamp Torque : 5.0N·m)	①TKY30R ②TKY25D
GYHR/L2525M00-M25R/L			
GYHR/L3225P00-M25R/L			
GYHR/L3232P00-M25R/L			

Dimensions (mm) ★1								
H	B	LF	LH	LH 2	HF	WF	HBH	
20	20	125	39	60	20	26	5	R
20	20	125	39	60	20	26	5	
25	25	150	39	57	25	28	—	R
25	25	150	39	57	25	28	—	
32	25	170	39	57	32	28	—	R
32	25	170	39	57	32	28	—	
32	32	170	39	57	32	35	—	R
32	32	170	39	57	32	35	—	
20	20	125	39	60	20	26	5	L
20	20	125	39	60	20	26	5	
25	25	150	39	57	25	28	—	L
25	25	150	39	57	25	28	—	
32	25	170	39	57	32	28	—	L
32	25	170	39	57	32	28	—	
32	32	170	39	57	32	35	—	L
32	32	170	39	57	32	35	—	
20	20	125	39	60	20	26	5	L
20	20	125	39	60	20	26	5	
25	25	150	39	57	25	28	—	L
25	25	150	39	57	25	28	—	
32	25	170	39	57	32	28	—	L
32	25	170	39	57	32	28	—	
32	32	170	39	57	32	35	—	L
32	32	170	39	57	32	35	—	

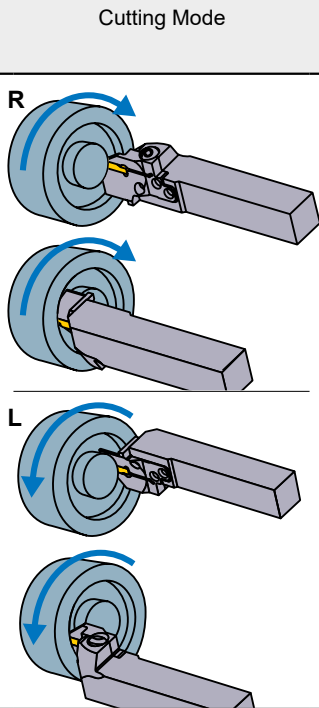

Insert selection

Seat Size	Geometry name				
F	GY○○0300/0318/0324F○○○○—Breaker shown below				

For grooving/cutting off breaker > F012, F013					
Seat Size	Breaker	GU	GS	GM	GFGS
		(For gummy steel)	(Low)	(Medium)	(Hardened steel)
F	3.00mm	●	●	●	●
	3.18mm	●	●	●	●

For multifunctional grooving breaker > F014, F015					
Seat Size	Breaker	MF	MS	MM	BM
		(Finish)	(Low)	(Medium)	(Copying)
F	3.00mm				●
	RE 0.2	●	●	●	
	RE 0.4	●	●	●	
	RE 0.8			●	
	3.18mm				●
	RE 0.2	●			
RE 0.4	●				
3.24mm	●				

● : Standard insert with dimensions

T

GROOVING / CUTTING OFF

IDENTIFICATION > F008, F009
 CUTTING CONDITIONS > F104
 CAUTION FOR USE > F106

GY SERIES (FACE GROOVING)

4

00° type holder

Insert	GY2M ^{GS} _{GM}	Insert	GY2G ^{MF}
Insert	GY2M ^{GU}	Insert	GY2M ^{MS}
Insert	GY1 ^{GM} _{GFGS}	Insert	GY2M ^{MM}

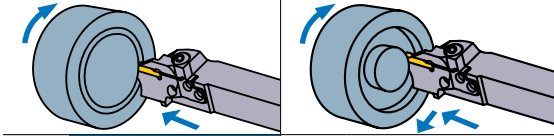

Insert GY2M^{BM}

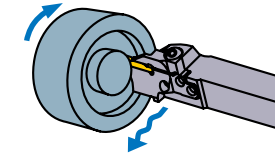

Note 1) For modular blades and modular holders, please order separately.
 Note 2) Please use right hand modular blade for right hand holder and left hand modular blade for left hand holder.

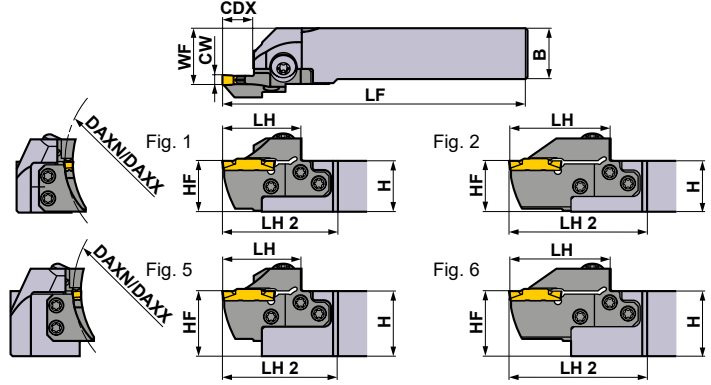

Right hand tool holder shown.

Seat Size	Dimensions (mm)				Type	Hand (R/L)	Order Number				Fig.
	CW	DAXN	DAXX	CDX			Holder	Stock	Modular Blade	Stock	
F	3.00 3.18 3.24	60	75	12	Modular	R	GYHR2020K00-M25R	●	GYM25RD-F12-060	●	3
					Modular	L	GYHL2020K00-M25L	●	GYM25LD-F12-060	●	3
					Modular	R	GYHR2525M00-M25R	●	GYM25RD-F12-060	●	1
					Modular	L	GYHL2525M00-M25L	●	GYM25LD-F12-060	●	1
					Modular	R	GYHR3225P00-M25R	●	GYM25RD-F12-060	●	5
					Modular	L	GYHL3225P00-M25L	●	GYM25LD-F12-060	●	5
					Modular	R	GYHR3232P00-M25R	●	GYM25RD-F12-060	●	5
					Modular	L	GYHL3232P00-M25L	●	GYM25LD-F12-060	●	5
	75	100	12	Modular	R	GYHR2020K00-M25R	●	GYM25RD-F20-060	●	4	
				Modular	L	GYHL2020K00-M25L	●	GYM25LD-F20-060	●	4	
				Modular	R	GYHR2525M00-M25R	●	GYM25RD-F20-060	●	2	
				Modular	L	GYHL2525M00-M25L	●	GYM25LD-F20-060	●	2	
			20 *2	Modular	R	GYHR3225P00-M25R	●	GYM25RD-F20-060	●	6	
				Modular	L	GYHL3225P00-M25L	●	GYM25LD-F20-060	●	6	
				Modular	R	GYHR3232P00-M25R	●	GYM25RD-F20-060	●	6	
				Modular	L	GYHL3232P00-M25L	●	GYM25LD-F20-060	●	6	
	75	100	12	Modular	R	GYHR2020K00-M25R	●	GYM25RD-F12-075	●	3	
				Modular	L	GYHL2020K00-M25L	●	GYM25LD-F12-075	●	3	
				Modular	R	GYHR2525M00-M25R	●	GYM25RD-F12-075	●	1	
				Modular	L	GYHL2525M00-M25L	●	GYM25LD-F12-075	●	1	
20 *2			Modular	R	GYHR3225P00-M25R	●	GYM25RD-F12-075	●	5		
			Modular	L	GYHL3225P00-M25L	●	GYM25LD-F12-075	●	5		
			Modular	R	GYHR3232P00-M25R	●	GYM25RD-F12-075	●	5		
			Modular	L	GYHL3232P00-M25L	●	GYM25LD-F12-075	●	5		
20 *2	Modular	R	GYHR2020K00-M25R	●	GYM25RD-F20-075	●	4				
	Modular	L	GYHL2020K00-M25L	●	GYM25LD-F20-075	●	4				
	Modular	R	GYHR2525M00-M25R	●	GYM25RD-F20-075	●	2				
	Modular	L	GYHL2525M00-M25L	●	GYM25LD-F20-075	●	2				
20 *2	Modular	R	GYHR3225P00-M25R	●	GYM25RD-F20-075	●	6				
	Modular	L	GYHL3225P00-M25L	●	GYM25LD-F20-075	●	6				
	Modular	R	GYHR3232P00-M25R	●	GYM25RD-F20-075	●	6				
	Modular	L	GYHL3232P00-M25L	●	GYM25LD-F20-075	●	6				

*1 Dimensions shown are when standard insert is used. If other insert geometries are used then LF, LH, LH2, and WF values may vary.
 *2 The maximum groove depth (CDX) varies according to the insert used. Please refer to the maximum groove depth (CDX) of inserts on pages F012—F015.

● : Inventory maintained.

GROOVING / CUTTING OFF

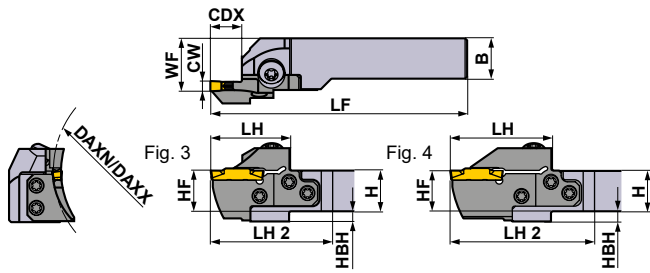

* Wrench : ① : Clamp Screw, ② : Blade Screw

SPARE PARTS			
Holder		5 pcs.	① ②
	Clamp Screw	Blade Screw	Wrench *
GYHR/L2020K00-M25R/L			
GYHR/L2525M00-M25R/L	GY06013M (Clamp Torque : 6.0N·m)	TS55 (Clamp Torque : 5.0N·m)	①TKY30R ②TKY25D
GYHR/L3225P00-M25R/L			
GYHR/L3232P00-M25R/L			

Right hand tool holder shown.

Dimensions (mm) *1									Cutting Mode
H	B	LF	LH	LH 2	HF	WF	HBH		
20	20	125	39	60	20	26	5	R	
20	20	125	39	60	20	26	5	R	
25	25	150	39	57	25	28	—		
25	25	150	39	57	25	28	—		
32	25	170	39	57	32	28	—		
32	25	170	39	57	32	28	—		
32	32	170	39	57	32	35	—		
32	32	170	39	57	32	35	—		
20	20	131	45	66	20	26	5		
20	20	131	45	66	20	26	5		
25	25	156	45	63	25	28	—		
25	25	156	45	63	25	28	—		
32	25	176	45	63	32	28	—		
32	25	176	45	63	32	28	—		
32	32	176	45	63	32	35	—		
32	32	176	45	63	32	35	—		
20	20	125	39	60	20	26	5		
20	20	125	39	60	20	26	5		
25	25	150	39	57	25	28	—		
25	25	150	39	57	25	28	—		
32	25	170	39	57	32	28	—		
32	25	170	39	57	32	28	—		
32	32	170	39	57	32	35	—		
32	32	170	39	57	32	35	—		
20	20	131	45	66	20	26	5		
20	20	131	45	66	20	26	5		
25	25	156	45	63	25	28	—		
25	25	156	45	63	25	28	—		
32	25	176	45	63	32	28	—		
32	25	176	45	63	32	28	—		
32	32	176	45	63	32	35	—		
32	32	176	45	63	32	35	—		

Insert selection

Seat Size	Geometry name
F	GY○○0300/0318/0324F○○○○○Breaker shown below

For grooving/cutting off breaker > F012, F013					
Seat Size	Breaker CW	GU	GS	GM	GFGS
		(For gummy steel)	(Low)	(Medium)	(Hardened steel)
F	3.00mm	●	●	●	●
	3.18mm	●	●	●	●

For multifunctional grooving breaker > F014, F015					
Seat Size	Breaker CW	MF	MS	MM	BM
		(Finish)	(Low)	(Medium)	(Copying) Ball shape
F	3.00mm	●	●	●	●
	RE 0.2	●	●	●	●
	RE 0.4	●	●	●	●
	RE 0.8	●	●	●	●
	3.18mm	●	●	●	●
	RE 0.2	●	●	●	●
	RE 0.4	●	●	●	●
	3.24mm	●	●	●	●

● : Standard insert with dimensions

T

GROOVING / CUTTING OFF

IDENTIFICATION > F008, F009
 CUTTING CONDITIONS > F104
 CAUTION FOR USE > F106

GY SERIES (FACE GROOVING)

4

00° type holder

Note 1) For modular blades and modular holders, please order separately.

Note 2) Please use right hand modular blade for right hand holder and left hand modular blade for left hand holder.

Insert	GY2M ^{GS} _{GM}	Insert	GY2G ^{MF}
Insert	GY2M ^{GU}	Insert	GY2M ^{MS}
Insert	GY1 ^M _G ^{GM} _{GFGS}	Insert	GY2M ^{MM}

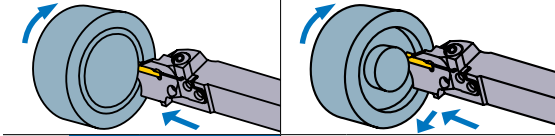

Insert GY2M^{BM}

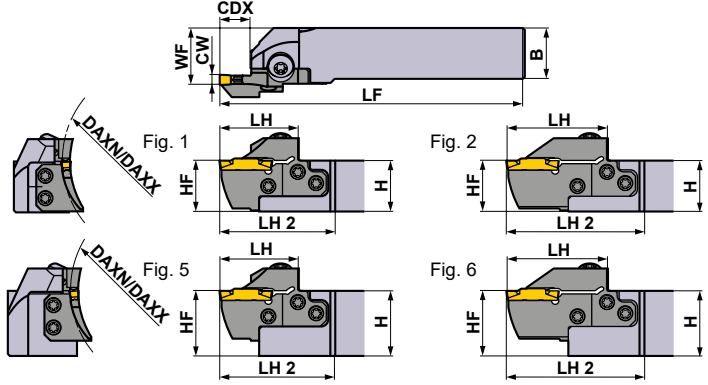
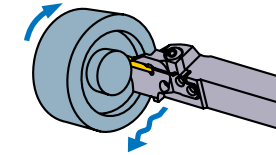

Right hand tool holder shown.

Seat Size	Dimensions (mm)				Type	Hand (R/L)	Order Number				Fig.
	CW	DAXN	DAXX	CDX			Holder	Stock	Modular Blade	Stock	
F	3.00 3.18 3.24	100	150	12	Modular	R	GYHR2020K00-M25R	●	GYM25RD-F12-100	●	3
					Modular	L	GYHL2020K00-M25L	●	GYM25LD-F12-100	●	3
					Modular	R	GYHR2525M00-M25R	●	GYM25RD-F12-100	●	1
					Modular	L	GYHL2525M00-M25L	●	GYM25LD-F12-100	●	1
					Modular	R	GYHR3225P00-M25R	●	GYM25RD-F12-100	●	5
					Modular	L	GYHL3225P00-M25L	●	GYM25LD-F12-100	●	5
		20 *2	Modular	R	GYHR2020K00-M25R	●	GYM25RD-F20-100	●	4		
			Modular	L	GYHL2020K00-M25L	●	GYM25LD-F20-100	●	4		
			Modular	R	GYHR2525M00-M25R	●	GYM25RD-F20-100	●	2		
			Modular	L	GYHL2525M00-M25L	●	GYM25LD-F20-100	●	2		
			Modular	R	GYHR3225P00-M25R	●	GYM25RD-F20-100	●	6		
			Modular	L	GYHL3225P00-M25L	●	GYM25LD-F20-100	●	6		
	135	200	12	Modular	R	GYHR2020K00-M25R	●	GYM25RD-F12-135	●	3	
				Modular	L	GYHL2020K00-M25L	●	GYM25LD-F12-135	●	3	
				Modular	R	GYHR2525M00-M25R	●	GYM25RD-F12-135	●	1	
				Modular	L	GYHL2525M00-M25L	●	GYM25LD-F12-135	●	1	
				Modular	R	GYHR3225P00-M25R	●	GYM25RD-F12-135	●	5	
				Modular	L	GYHL3225P00-M25L	●	GYM25LD-F12-135	●	5	
		20 *2	Modular	R	GYHR2020K00-M25R	●	GYM25RD-F20-135	●	4		
			Modular	L	GYHL2020K00-M25L	●	GYM25LD-F20-135	●	4		
			Modular	R	GYHR2525M00-M25R	●	GYM25RD-F20-135	●	2		
			Modular	L	GYHL2525M00-M25L	●	GYM25LD-F20-135	●	2		
			Modular	R	GYHR3225P00-M25R	●	GYM25RD-F20-135	●	6		
			Modular	L	GYHL3225P00-M25L	●	GYM25LD-F20-135	●	6		

*1 Dimensions shown are when standard insert is used. If other insert geometries are used then LF, LH, LH2, and WF values may vary.

*2 The maximum groove depth (CDX) varies according to the insert used. Please refer to the maximum groove depth (CDX) of inserts on pages F012—F015.

● : Inventory maintained.

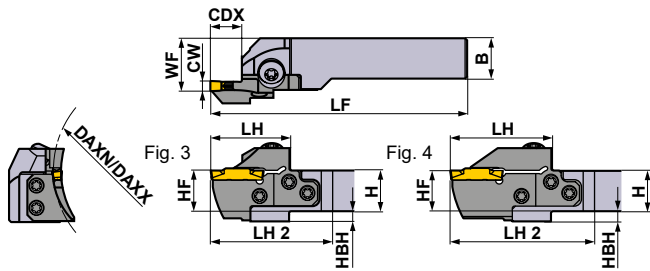

* Wrench : ① : Clamp Screw, ② : Blade Screw

SPARE PARTS			
Holder		5 pcs.	① ②
	Clamp Screw	Blade Screw	Wrench *
GYHR/L2020K00-M25R/L			
GYHR/L2525M00-M25R/L	GY06013M (Clamp Torque : 6.0N·m)	TS55 (Clamp Torque : 5.0N·m)	①TKY30R ②TKY25D
GYHR/L3225P00-M25R/L			
GYHR/L3232P00-M25R/L			

Right hand tool holder shown.

Dimensions (mm) *1									Cutting Mode
H	B	LF	LH	LH 2	HF	WF	HBH		
20	20	125	39	60	20	26	5	R	
20	20	125	39	60	20	26	5	R	
25	25	150	39	57	25	28	—		
25	25	150	39	57	25	28	—		
32	25	170	39	57	32	28	—		
32	25	170	39	57	32	28	—		
32	32	170	39	57	32	35	—		
32	32	170	39	57	32	35	—		
20	20	131	45	66	20	26	5		
20	20	131	45	66	20	26	5		
25	25	156	45	63	25	28	—		
25	25	156	45	63	25	28	—		
32	25	176	45	63	32	28	—		
32	25	176	45	63	32	28	—		
32	32	176	45	63	32	35	—		
32	32	176	45	63	32	35	—		
20	20	125	39	60	20	26	5		
20	20	125	39	60	20	26	5		
25	25	150	39	57	25	28	—		
25	25	150	39	57	25	28	—		
32	25	170	39	57	32	28	—		
32	25	170	39	57	32	28	—		
32	32	170	39	57	32	35	—		
32	32	170	39	57	32	35	—		
20	20	131	45	66	20	26	5		
20	20	131	45	66	20	26	5		
25	25	156	45	63	25	28	—		
25	25	156	45	63	25	28	—		
32	25	176	45	63	32	28	—		
32	25	176	45	63	32	28	—		
32	32	176	45	63	32	35	—		
32	32	176	45	63	32	35	—		

Insert selection

Seat Size	Geometry name
F	GY○○0300/0318/0324F○○○○○Breaker shown below

For grooving/cutting off breaker > F012, F013					
Seat Size	Breaker CW	GU	GS	GM	GFGS
		(For gummy steel)	(Low)	(Medium)	(Hardened steel)
F	3.00mm	●	●	●	●
	3.18mm	●	●	●	●

For multifunctional grooving breaker > F014, F015					
Seat Size	Breaker CW	MF	MS	MM	BM
		(Finish)	(Low)	(Medium)	(Copying) Ball shape
F	3.00mm				●
	RE 0.2	●	●	●	
	RE 0.4	●	●	●	
	RE 0.8			●	
	3.18mm				●
	RE 0.2	●			
	RE 0.4	●			
	3.24mm	●			

● : Standard insert with dimensions

GROOVING / CUTTING OFF

IDENTIFICATION > F008, F009
 CUTTING CONDITIONS > F104
 CAUTION FOR USE > F106

GY SERIES (FACE GROOVING)

4

00° type holder

Note 1) For modular blades and modular holders, please order separately.

Note 2) Please use right hand modular blade for right hand holder and left hand modular blade for left hand holder.

Insert	GY2M ^{GS} _{GM}	Insert	GY2G ^{MF}
Insert	GY2M ^{GU}	Insert	GY2M ^{MS}
Insert	GY1 ^{GM} _{GFGS}	Insert	GY2M ^{MM}

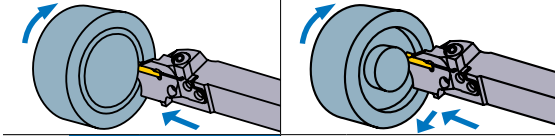

Insert GY2M^{BM}

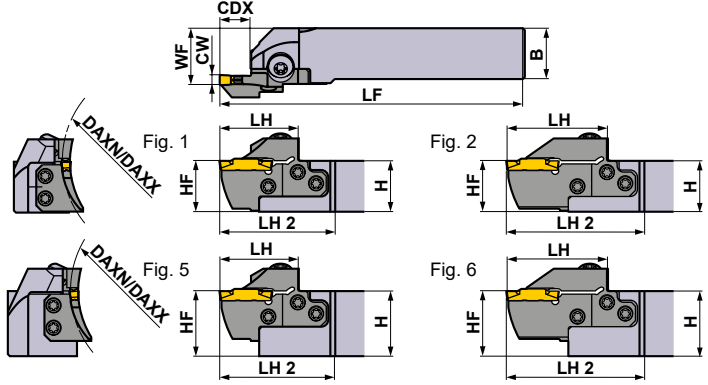
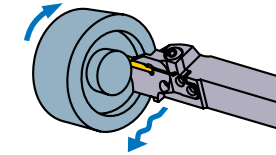

Right hand tool holder shown.

Seat Size	Dimensions (mm)				Type	Hand (R/L)	Order Number				Fig.
	CW	DAXN	DAXX	CDX			Holder	Stock	Modular Blade	Stock	
F	3.00 3.18 3.24	180	250	12	Modular	R	GYHR2020K00-M25R	●	GYM25RD-F12-180	●	3
					Modular	L	GYHL2020K00-M25L	●	GYM25LD-F12-180	●	3
					Modular	R	GYHR2525M00-M25R	●	GYM25RD-F12-180	●	1
					Modular	L	GYHL2525M00-M25L	●	GYM25LD-F12-180	●	1
					Modular	R	GYHR3225P00-M25R	●	GYM25RD-F12-180	●	5
					Modular	L	GYHL3225P00-M25L	●	GYM25LD-F12-180	●	5
					Modular	R	GYHR3232P00-M25R	●	GYM25RD-F12-180	●	5
					Modular	L	GYHL3232P00-M25L	●	GYM25LD-F12-180	●	5
	225	999	12	Modular	R	GYHR2020K00-M25R	●	GYM25RD-F20-180	●	4	
				Modular	L	GYHL2020K00-M25L	●	GYM25LD-F20-180	●	4	
				Modular	R	GYHR2525M00-M25R	●	GYM25RD-F20-180	●	2	
				Modular	L	GYHL2525M00-M25L	●	GYM25LD-F20-180	●	2	
			20 *2	Modular	R	GYHR3225P00-M25R	●	GYM25RD-F20-180	●	6	
				Modular	L	GYHL3225P00-M25L	●	GYM25LD-F20-180	●	6	
				Modular	R	GYHR3232P00-M25R	●	GYM25RD-F20-180	●	6	
				Modular	L	GYHL3232P00-M25L	●	GYM25LD-F20-180	●	6	
225	999	12	Modular	R	GYHR2020K00-M25R	●	GYM25RD-F12-225	●	3		
			Modular	L	GYHL2020K00-M25L	●	GYM25LD-F12-225	●	3		
			Modular	R	GYHR2525M00-M25R	●	GYM25RD-F12-225	●	1		
			Modular	L	GYHL2525M00-M25L	●	GYM25LD-F12-225	●	1		
		20 *2	Modular	R	GYHR3225P00-M25R	●	GYM25RD-F12-225	●	5		
			Modular	L	GYHL3225P00-M25L	●	GYM25LD-F12-225	●	5		
			Modular	R	GYHR3232P00-M25R	●	GYM25RD-F12-225	●	5		
			Modular	L	GYHL3232P00-M25L	●	GYM25LD-F12-225	●	5		
20 *2	Modular	R	GYHR2020K00-M25R	●	GYM25RD-F20-225	●	4				
	Modular	L	GYHL2020K00-M25L	●	GYM25LD-F20-225	●	4				
	Modular	R	GYHR2525M00-M25R	●	GYM25RD-F20-225	●	2				
	Modular	L	GYHL2525M00-M25L	●	GYM25LD-F20-225	●	2				
20 *2	Modular	R	GYHR3225P00-M25R	●	GYM25RD-F20-225	●	6				
	Modular	L	GYHL3225P00-M25L	●	GYM25LD-F20-225	●	6				
	Modular	R	GYHR3232P00-M25R	●	GYM25RD-F20-225	●	6				
	Modular	L	GYHL3232P00-M25L	●	GYM25LD-F20-225	●	6				

*1 Dimensions shown are when standard insert is used. If other insert geometries are used then LF, LH, LH2, and WF values may vary.

*2 The maximum groove depth (CDX) varies according to the insert used. Please refer to the maximum groove depth (CDX) of inserts on pages F012—F015.

● : Inventory maintained.

GROOVING / CUTTING OFF

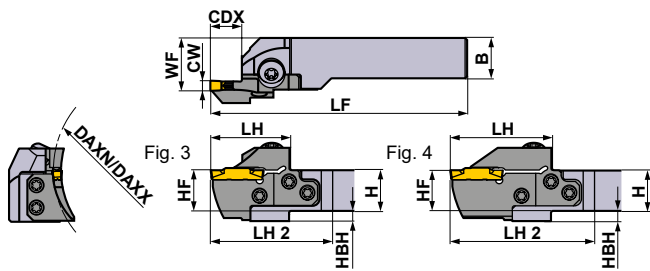

* Wrench : ① : Clamp Screw, ② : Blade Screw

SPARE PARTS			
Holder	Clamp Screw	Blade Screw 5 pcs.	Wrench *
GYHR/L2020K00-M25R/L			
GYHR/L2525M00-M25R/L	GY06013M (Clamp Torque : 6.0N·m)	TS55 (Clamp Torque : 5.0N·m)	①TKY30R ②TKY25D
GYHR/L3225P00-M25R/L			
GYHR/L3232P00-M25R/L			

Right hand tool holder shown.

Dimensions (mm) *1									Cutting Mode
H	B	LF	LH	LH 2	HF	WF	HBH		
20	20	125	39	60	20	26	5	R	
20	20	125	39	60	20	26	5	R	
25	25	150	39	57	25	28	—		
25	25	150	39	57	25	28	—		
32	25	170	39	57	32	28	—		
32	25	170	39	57	32	28	—		
32	32	170	39	57	32	35	—		
32	32	170	39	57	32	35	—		
20	20	131	45	66	20	26	5		
20	20	131	45	66	20	26	5		
25	25	156	45	63	25	28	—		
25	25	156	45	63	25	28	—		
32	25	176	45	63	32	28	—		
32	25	176	45	63	32	28	—		
32	32	176	45	63	32	35	—		
32	32	176	45	63	32	35	—		
20	20	125	39	60	20	26	5		
20	20	125	39	60	20	26	5		
25	25	150	39	57	25	28	—		
25	25	150	39	57	25	28	—		
32	25	170	39	57	32	28	—		
32	25	170	39	57	32	28	—		
32	32	170	39	57	32	35	—		
32	32	170	39	57	32	35	—		
20	20	131	45	66	20	26	5		
20	20	131	45	66	20	26	5		
25	25	156	45	63	25	28	—		
25	25	156	45	63	25	28	—		
32	25	176	45	63	32	28	—		
32	25	176	45	63	32	28	—		
32	32	176	45	63	32	35	—		
32	32	176	45	63	32	35	—		

Insert selection

Seat Size	Geometry name
F	GY○○0300/0318/0324F○○○○○Breaker shown below

For grooving/cutting off breaker > F012, F013					
Seat Size	Breaker CW	GU	GS	GM	GFGS
		(For gummy steel)	(Low)	(Medium)	(Hardened steel)
F	3.00mm	●	●	●	●
	3.18mm	●	●	●	●

For multifunctional grooving breaker > F014, F015					
Seat Size	Breaker CW	MF	MS	MM	BM
		(Finish)	(Low)	(Medium)	(Copying) Ball shape
F	3.00mm				●
	RE 0.2	●	●	●	
	RE 0.4	●	●	●	
	RE 0.8			●	
	3.18mm				●
	RE 0.2	●			
RE 0.4	●				
3.24mm	●				

● : Standard insert with dimensions

GROOVING / CUTTING OFF

IDENTIFICATION > F008, F009
 CUTTING CONDITIONS > F104
 CAUTION FOR USE > F106

GY SERIES (FACE GROOVING)

4

00° type holder

Insert	GY2M ^{GS} _{GM}	Insert	GY2G ^{MF}
Insert	GY2M ^{GU}	Insert	GY2M ^{MS}
Insert	GY1 ^{GM} _{GFGS}	Insert	GY2M ^{MM}

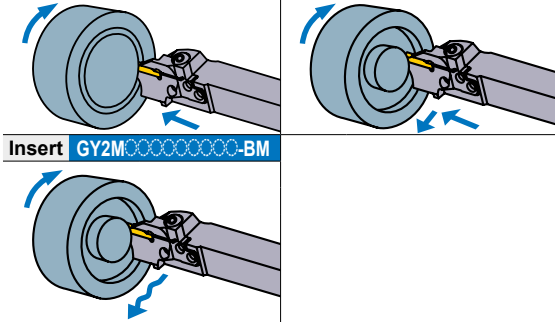

Note 1) For modular blades and modular holders, please order separately.
 Note 2) Please use right hand modular blade for right hand holder and left hand modular blade for left hand holder.

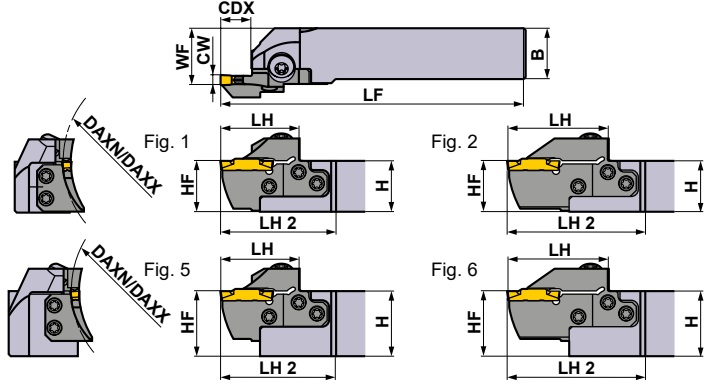

Right hand tool holder shown.

Seat Size	Dimensions (mm)				Type	Hand (R/L)	Order Number				Fig.
	CW	DAXN	DAXX	CDX			Holder	Stock	Modular Blade	Stock	
G	4.00	40	50	14	Modular	R	GYHR2020K00-M25R	●	GYM25RD-G14-040	●	3
					L	GYHL2020K00-M25L	●	GYM25LD-G14-040	●	3	
					R	GYHR2525M00-M25R	●	GYM25RD-G14-040	●	1	
					L	GYHL2525M00-M25L	●	GYM25LD-G14-040	●	1	
		R	GYHR3225P00-M25R	●	GYM25RD-G14-040	●	5				
		L	GYHL3225P00-M25L	●	GYM25LD-G14-040	●	5				
		R	GYHR3232P00-M25R	●	GYM25RD-G14-040	●	5				
		L	GYHL3232P00-M25L	●	GYM25LD-G14-040	●	5				
	4.24	50	60	14	Modular	R	GYHR2020K00-M25R	●	GYM25RD-G14-050	●	3
					L	GYHL2020K00-M25L	●	GYM25LD-G14-050	●	3	
					R	GYHR2525M00-M25R	●	GYM25RD-G14-050	●	1	
					L	GYHL2525M00-M25L	●	GYM25LD-G14-050	●	1	
		R	GYHR3225P00-M25R	●	GYM25RD-G14-050	●	5				
		L	GYHL3225P00-M25L	●	GYM25LD-G14-050	●	5				
		R	GYHR3232P00-M25R	●	GYM25RD-G14-050	●	5				
		L	GYHL3232P00-M25L	●	GYM25LD-G14-050	●	5				
	60	85	14	Modular	R	GYHR2020K00-M25R	●	GYM25RD-G14-060	●	3	
				L	GYHL2020K00-M25L	●	GYM25LD-G14-060	●	3		
				R	GYHR2525M00-M25R	●	GYM25RD-G14-060	●	1		
				L	GYHL2525M00-M25L	●	GYM25LD-G14-060	●	1		
R		GYHR3225P00-M25R	●	GYM25RD-G14-060	●	5					
L		GYHL3225P00-M25L	●	GYM25LD-G14-060	●	5					
R		GYHR3232P00-M25R	●	GYM25RD-G14-060	●	5					
L		GYHL3232P00-M25L	●	GYM25LD-G14-060	●	5					
25*2			Modular	R	GYHR2020K00-M25R	●	GYM25RD-G25-060	●	4		
			L	GYHL2020K00-M25L	●	GYM25LD-G25-060	●	4			
			R	GYHR2525M00-M25R	●	GYM25RD-G25-060	●	2			
			L	GYHL2525M00-M25L	●	GYM25LD-G25-060	●	2			
R	GYHR3225P00-M25R	●	GYM25RD-G25-060	●	6						
L	GYHL3225P00-M25L	●	GYM25LD-G25-060	●	6						
R	GYHR3232P00-M25R	●	GYM25RD-G25-060	●	6						
L	GYHL3232P00-M25L	●	GYM25LD-G25-060	●	6						

*1 Dimensions shown are when standard insert is used. If other insert geometries are used then LF, LH, LH2, and WF values may vary.
 *2 The maximum groove depth (CDX) varies according to the insert used. Please refer to the maximum groove depth (CDX) of inserts on pages F012—F015.

● : Inventory maintained.

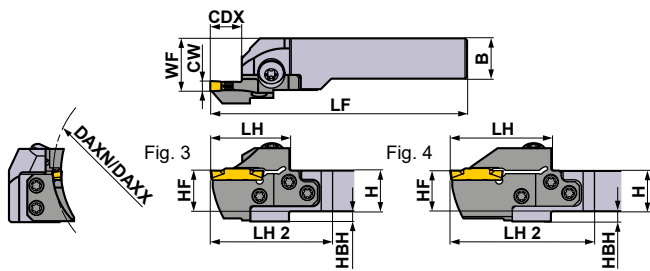

* Wrench : ① : Clamp Screw, ② : Blade Screw

SPARE PARTS			
Holder	Clamp Screw	Blade Screw 5 pcs.	Wrench *
GYHR/L2020K00-M25R/L	GY06013M (Clamp Torque : 6.0N·m)	TS55 (Clamp Torque : 5.0N·m)	①TKY30R ②TKY25D
GYHR/L2525M00-M25R/L			
GYHR/L3225P00-M25R/L			
GYHR/L3232P00-M25R/L			

Right hand tool holder shown.

Dimensions (mm) *1									Cutting Mode
H	B	LF	LH	LH 2	HF	WF	HBH		
20	20	125	39	60	20	26	5	R	
20	20	125	39	60	20	26	5		
25	25	150	39	57	25	28	—		
25	25	150	39	57	25	28	—		
32	25	170	39	57	32	28	—		
32	25	170	39	57	32	28	—		
32	32	170	39	57	32	35	—		
32	32	170	39	57	32	35	—		
20	20	125	39	60	20	26	5	R	
20	20	125	39	60	20	26	5		
25	25	150	39	57	25	28	—		
25	25	150	39	57	25	28	—		
32	25	170	39	57	32	28	—		
32	25	170	39	57	32	28	—		
32	32	170	39	57	32	35	—		
32	32	170	39	57	32	35	—		
20	20	125	39	60	20	26	5	L	
20	20	125	39	60	20	26	5		
25	25	150	39	57	25	28	—		
25	25	150	39	57	25	28	—		
32	25	170	39	57	32	28	—		
32	25	170	39	57	32	28	—		
32	32	170	39	57	32	35	—		
32	32	170	39	57	32	35	—		
20	20	136	50	71	20	26	5	L	
20	20	136	50	71	20	26	5		
25	25	161	50	68	25	28	—		
25	25	161	50	68	25	28	—		
32	25	181	50	68	32	28	—		
32	25	181	50	68	32	28	—		
32	32	181	50	68	32	35	—		
32	32	181	50	68	32	35	—		

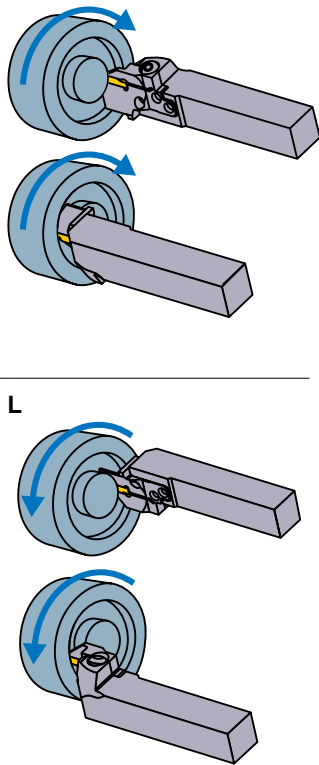

Insert selection

Seat Size	Geometry name
G	GY○○○0400/0424G○○○○○-Breaker shown below

For grooving/cutting off breaker > F012, F013					
Seat Size	Breaker	GU (For gummy steel)	GS (Low)	GM (Medium)	GFGS (Hardened steel)
G	4.00mm	●	●	●	●

For multifunctional grooving breaker > F014, F015					
Seat Size	Breaker	MF (Finish)	MS (Low)	MM (Medium)	BM (Copying) Ball shape
G	4.00mm	●	●	●	●
	RE 0.2	●	●	●	●
	RE 0.4	●	●	●	●
	RE 0.8	●	●	●	●
	4.24mm	●			

● : Standard insert with dimensions

GROOVING / CUTTING OFF

IDENTIFICATION > F008, F009
 CUTTING CONDITIONS > F104
 CAUTION FOR USE > F106

GY SERIES (FACE GROOVING)

4

00° type holder

Insert	GY2M ^{GS} _{GM}	Insert	GY2G ^{MF}
Insert	GY2M ^{GU}	Insert	GY2M ^{MS}
Insert	GY1 ^{GM} _{GFGS}	Insert	GY2M ^{MM}

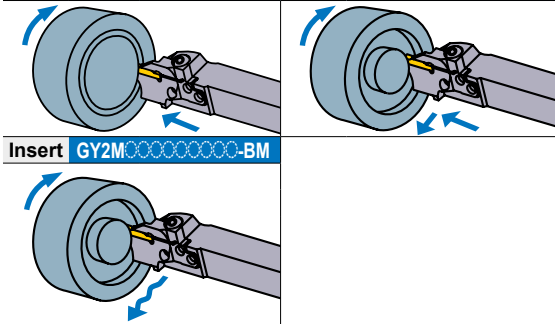

Note 1) For modular blades and modular holders, please order separately.
 Note 2) Please use right hand modular blade for right hand holder and left hand modular blade for left hand holder.

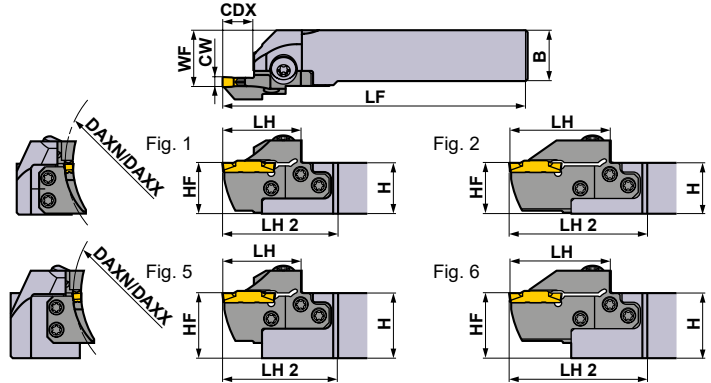

Right hand tool holder shown.

Seat Size	Dimensions (mm)				Type	Hand (R/L)	Order Number				Fig.
	CW	DAXN	DAXX	CDX			Holder	Stock	Modular Blade	Stock	
G	4.00	85	125	14	Modular	R	GYHR2020K00-M25R	●	GYM25RD-G14-085	●	3
					Modular	L	GYHL2020K00-M25L	●	GYM25LD-G14-085	●	3
					Modular	R	GYHR2525M00-M25R	●	GYM25RD-G14-085	●	1
					Modular	L	GYHL2525M00-M25L	●	GYM25LD-G14-085	●	1
					Modular	R	GYHR3225P00-M25R	●	GYM25RD-G14-085	●	5
					Modular	L	GYHL3225P00-M25L	●	GYM25LD-G14-085	●	5
					Modular	R	GYHR3232P00-M25R	●	GYM25RD-G14-085	●	5
					Modular	L	GYHL3232P00-M25L	●	GYM25LD-G14-085	●	5
	4.24	125	200	14	Modular	R	GYHR2020K00-M25R	●	GYM25RD-G25-085	●	4
					Modular	L	GYHL2020K00-M25L	●	GYM25LD-G25-085	●	4
					Modular	R	GYHR2525M00-M25R	●	GYM25RD-G25-085	●	2
					Modular	L	GYHL2525M00-M25L	●	GYM25LD-G25-085	●	2
				25 *2	Modular	R	GYHR3225P00-M25R	●	GYM25RD-G25-085	●	6
					Modular	L	GYHL3225P00-M25L	●	GYM25LD-G25-085	●	6
					Modular	R	GYHR3232P00-M25R	●	GYM25RD-G25-085	●	6
					Modular	L	GYHL3232P00-M25L	●	GYM25LD-G25-085	●	6
	125	200	14	Modular	R	GYHR2020K00-M25R	●	GYM25RD-G14-125	●	3	
				Modular	L	GYHL2020K00-M25L	●	GYM25LD-G14-125	●	3	
				Modular	R	GYHR2525M00-M25R	●	GYM25RD-G14-125	●	1	
				Modular	L	GYHL2525M00-M25L	●	GYM25LD-G14-125	●	1	
25 *2			Modular	R	GYHR3225P00-M25R	●	GYM25RD-G14-125	●	5		
			Modular	L	GYHL3225P00-M25L	●	GYM25LD-G14-125	●	5		
			Modular	R	GYHR3232P00-M25R	●	GYM25RD-G14-125	●	5		
			Modular	L	GYHL3232P00-M25L	●	GYM25LD-G14-125	●	5		
25 *2	Modular	R	GYHR2020K00-M25R	●	GYM25RD-G25-125	●	4				
	Modular	L	GYHL2020K00-M25L	●	GYM25LD-G25-125	●	4				
	Modular	R	GYHR2525M00-M25R	●	GYM25RD-G25-125	●	2				
	Modular	L	GYHL2525M00-M25L	●	GYM25LD-G25-125	●	2				
25 *2	Modular	R	GYHR3225P00-M25R	●	GYM25RD-G25-125	●	6				
	Modular	L	GYHL3225P00-M25L	●	GYM25LD-G25-125	●	6				
	Modular	R	GYHR3232P00-M25R	●	GYM25RD-G25-125	●	6				
	Modular	L	GYHL3232P00-M25L	●	GYM25LD-G25-125	●	6				

*1 Dimensions shown are when standard insert is used. If other insert geometries are used then LF, LH, LH2, and WF values may vary.
 *2 The maximum groove depth (CDX) varies according to the insert used. Please refer to the maximum groove depth (CDX) of inserts on pages F012—F015.

● : Inventory maintained.

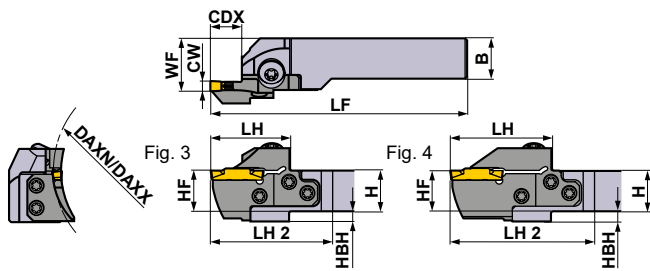

* Wrench : ① : Clamp Screw, ② : Blade Screw

SPARE PARTS			
Holder		5 pcs.	① ②
	Clamp Screw	Blade Screw	Wrench *
GYHR/L2020K00-M25R/L			
GYHR/L2525M00-M25R/L	GY06013M (Clamp Torque : 6.0N·m)	TS55 (Clamp Torque : 5.0N·m)	①TKY30R ②TKY25D
GYHR/L3225P00-M25R/L			
GYHR/L3232P00-M25R/L			

Right hand tool holder shown.

Dimensions (mm) *1									Cutting Mode
H	B	LF	LH	LH 2	HF	WF	HBH		
20	20	125	39	60	20	26	5	R	
20	20	125	39	60	20	26	5	R	
25	25	150	39	57	25	28	—		
25	25	150	39	57	25	28	—		
32	25	170	39	57	32	28	—		
32	25	170	39	57	32	28	—		
32	32	170	39	57	32	35	—		
32	32	170	39	57	32	35	—		
20	20	136	50	71	20	26	5	L	
20	20	136	50	71	20	26	5		
25	25	161	50	68	25	28	—		
25	25	161	50	68	25	28	—		
32	25	181	50	68	32	28	—		
32	25	181	50	68	32	28	—		
32	32	181	50	68	32	35	—		
32	32	181	50	68	32	35	—		
20	20	125	39	60	20	26	5		
20	20	125	39	60	20	26	5		
25	25	150	39	57	25	28	—		
25	25	150	39	57	25	28	—		
32	25	170	39	57	32	28	—		
32	25	170	39	57	32	28	—		
32	32	170	39	57	32	35	—		
32	32	170	39	57	32	35	—		
20	20	136	50	71	20	26	5		
20	20	136	50	71	20	26	5		
25	25	161	50	68	25	28	—		
25	25	161	50	68	25	28	—		
32	25	181	50	68	32	28	—		
32	25	181	50	68	32	28	—		
32	32	181	50	68	32	35	—		
32	32	181	50	68	32	35	—		

Insert selection

Seat Size	Geometry name				
G	GY○○0400/0424G○○○○-Breaker shown below				

For grooving/cutting off breaker > F012, F013					
Seat Size	Breaker	GU (For gummy steel)	GS (Low)	GM (Medium)	GFGS (Hardened steel)
G	4.00mm	●	●	●	●

For multifunctional grooving breaker > F014, F015					
Seat Size	Breaker	MF (Finish)	MS (Low)	MM (Medium)	BM (Copying) Ball shape
G	4.00mm	●	●	●	●
	RE 0.2	●	●	●	●
	RE 0.4	●	●	●	●
	RE 0.8	●	●	●	●
	4.24mm	●			

● : Standard insert with dimensions

GROOVING / CUTTING OFF

IDENTIFICATION > F008, F009
 CUTTING CONDITIONS > F104
 CAUTION FOR USE > F106

GY SERIES (FACE GROOVING)

4

00° type holder

Note 1) For modular blades and modular holders, please order separately.

Note 2) Please use right hand modular blade for right hand holder and left hand modular blade for left hand holder.

Insert	GY2M ^{GS} _{GM}	Insert	GY2G ^{MF}
Insert	GY2M ^{GU}	Insert	GY2M ^{MS}
Insert	GY1 ^{GM} _{GFGS}	Insert	GY2M ^{MM}

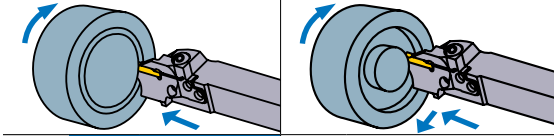

Insert GY2M^{BM}

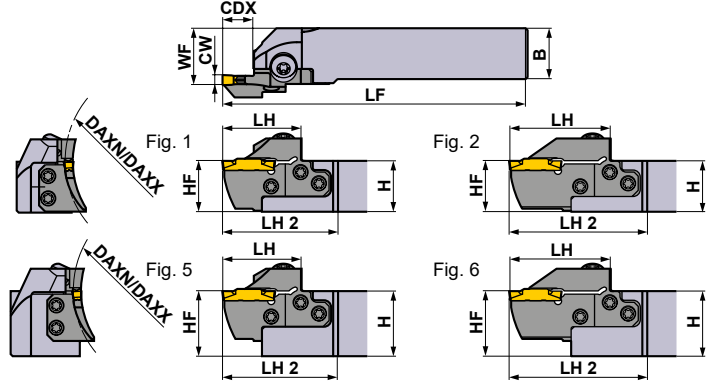
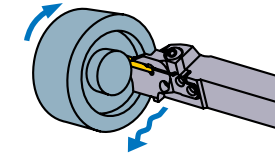

Right hand tool holder shown.

Seat Size	Dimensions (mm)				Type	Hand (R/L)	Order Number				Fig.
	CW	DAXN	DAXX	CDX			Holder	Stock	Modular Blade	Stock	
G	4.00	180	280	14	Modular	R	GYHR2020K00-M25R	●	GYM25RD-G14-180	●	3
					Modular	L	GYHL2020K00-M25L	●	GYM25LD-G14-180	●	3
					Modular	R	GYHR2525M00-M25R	●	GYM25RD-G14-180	●	1
					Modular	L	GYHL2525M00-M25L	●	GYM25LD-G14-180	●	1
					Modular	R	GYHR3225P00-M25R	●	GYM25RD-G14-180	●	5
					Modular	L	GYHL3225P00-M25L	●	GYM25LD-G14-180	●	5
					Modular	R	GYHR3232P00-M25R	●	GYM25RD-G14-180	●	5
					Modular	L	GYHL3232P00-M25L	●	GYM25LD-G14-180	●	5
	4.24	250	999	14	Modular	R	GYHR2020K00-M25R	●	GYM25RD-G25-180	●	4
					Modular	L	GYHL2020K00-M25L	●	GYM25LD-G25-180	●	4
					Modular	R	GYHR2525M00-M25R	●	GYM25RD-G25-180	●	2
					Modular	L	GYHL2525M00-M25L	●	GYM25LD-G25-180	●	2
				25*2	Modular	R	GYHR3225P00-M25R	●	GYM25RD-G25-180	●	6
					Modular	L	GYHL3225P00-M25L	●	GYM25LD-G25-180	●	6
					Modular	R	GYHR3232P00-M25R	●	GYM25RD-G25-180	●	6
					Modular	L	GYHL3232P00-M25L	●	GYM25LD-G25-180	●	6

*1 Dimensions shown are when standard insert is used. If other insert geometries are used then LF, LH, LH2, and WF values may vary.

*2 The maximum groove depth (CDX) varies according to the insert used. Please refer to the maximum groove depth (CDX) of inserts on pages F012—F015.

● : Inventory maintained.

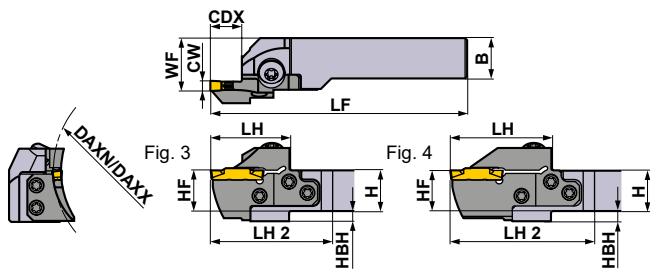

* Wrench : ① : Clamp Screw, ② : Blade Screw

SPARE PARTS			
Holder	Clamp Screw	Blade Screw 5 pcs.	Wrench *
GYHR/L2020K00-M25R/L	GY06013M (Clamp Torque : 6.0N·m)	TS55 (Clamp Torque : 5.0N·m)	①TKY30R ②TKY25D
GYHR/L2525M00-M25R/L			
GYHR/L3225P00-M25R/L			
GYHR/L3232P00-M25R/L			

Right hand tool holder shown.

Dimensions (mm) *1									Cutting Mode
H	B	LF	LH	LH 2	HF	WF	HBH		
20	20	125	39	60	20	26	5	R	
20	20	125	39	60	20	26	5	R	
25	25	150	39	57	25	28	—	R	
25	25	150	39	57	25	28	—		
32	25	170	39	57	32	28	—	R	
32	25	170	39	57	32	28	—		
32	32	170	39	57	32	35	—	R	
32	32	170	39	57	32	35	—		
20	20	136	50	71	20	26	5	R	
20	20	136	50	71	20	26	5		
25	25	161	50	68	25	28	—	R	
25	25	161	50	68	25	28	—		
32	25	181	50	68	32	28	—	R	
32	25	181	50	68	32	28	—		
32	32	181	50	68	32	35	—	R	
32	32	181	50	68	32	35	—		
20	20	125	39	60	20	26	5	L	
20	20	125	39	60	20	26	5		
25	25	150	39	57	25	28	—	L	
25	25	150	39	57	25	28	—		
32	25	170	39	57	32	28	—	L	
32	25	170	39	57	32	28	—		
32	32	170	39	57	32	35	—	L	
32	32	170	39	57	32	35	—		
20	20	136	50	71	20	26	5	L	
20	20	136	50	71	20	26	5		
25	25	161	50	68	25	28	—	L	
25	25	161	50	68	25	28	—		
32	25	181	50	68	32	28	—	L	
32	25	181	50	68	32	28	—		
32	32	181	50	68	32	35	—	L	
32	32	181	50	68	32	35	—		

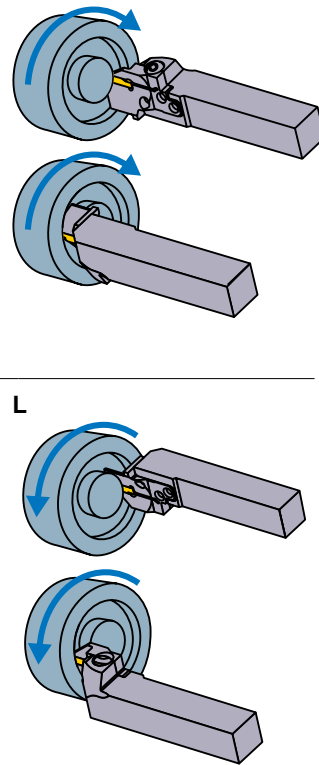

Insert selection

Seat Size	Geometry name
G	GY○○0400/0424G○○○-Breaker shown below

For grooving/cutting off breaker > F012, F013					
Seat Size	Breaker	GU (For gummy steel)	GS (Low)	GM (Medium)	GFGS (Hardened steel)
G	4.00mm	●	●	●	●

For multifunctional grooving breaker > F014, F015					
Seat Size	Breaker	MF (Finish)	MS (Low)	MM (Medium)	BM (Copying) Ball shape
G	4.00mm	●	●	●	●
	RE 0.2	●	●	●	●
	RE 0.4	●	●	●	●
	RE 0.8	●	●	●	●
	4.24mm	●			

● : Standard insert with dimensions

GROOVING / CUTTING OFF

IDENTIFICATION > F008, F009
 CUTTING CONDITIONS > F104
 CAUTION FOR USE > F106

GY SERIES (FACE GROOVING)

4 00° type holder

Insert	GY2M ^{GS} _{GM}	Insert	GY2G ^{MF}
Insert	GY2M ^{GU}	Insert	GY2M ^{MS}
Insert	GY1 ^{GM} _{GFGS}	Insert	GY2M ^{MM}

Note 1) For modular blades and modular holders, please order separately.
 Note 2) Please use right hand modular blade for right hand holder and left hand modular blade for left hand holder.

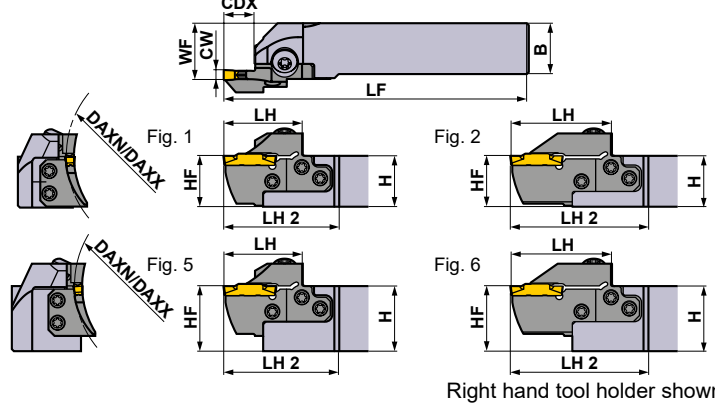

Right hand tool holder shown.

Seat Size	Dimensions (mm)				Type	Hand (R/L)	Order Number				Fig.
	CW	DAXN	DAXX	CDX			Holder	Stock	Modular Blade	Stock	
H	4.75 5.00 5.24	50	60	14	Modular	R	GYHR2020K00-M25R	●	GYM25RD-H14-050	●	3
					Modular	L	GYHL2020K00-M25L	●	GYM25LD-H14-050	●	3
					Modular	R	GYHR2525M00-M25R	●	GYM25RD-H14-050	●	1
					Modular	L	GYHL2525M00-M25L	●	GYM25LD-H14-050	●	1
		Modular	R	GYHR3225P00-M25R	●	GYM25RD-H14-050	●	5			
		Modular	L	GYHL3225P00-M25L	●	GYM25LD-H14-050	●	5			
		Modular	R	GYHR3232P00-M25R	●	GYM25RD-H14-050	●	5			
		Modular	L	GYHL3232P00-M25L	●	GYM25LD-H14-050	●	5			
	60	85	14	Modular	R	GYHR2020K00-M25R	●	GYM25RD-H14-060	●	3	
				Modular	L	GYHL2020K00-M25L	●	GYM25LD-H14-060	●	3	
				Modular	R	GYHR2525M00-M25R	●	GYM25RD-H14-060	●	1	
				Modular	L	GYHL2525M00-M25L	●	GYM25LD-H14-060	●	1	
		Modular	R	GYHR3225P00-M25R	●	GYM25RD-H14-060	●	5			
		Modular	L	GYHL3225P00-M25L	●	GYM25LD-H14-060	●	5			
		Modular	R	GYHR3232P00-M25R	●	GYM25RD-H14-060	●	5			
		Modular	L	GYHL3232P00-M25L	●	GYM25LD-H14-060	●	5			
25 *2			Modular	R	GYHR2020K00-M25R	●	GYM25RD-H25-060	●	4		
			Modular	L	GYHL2020K00-M25L	●	GYM25LD-H25-060	●	4		
			Modular	R	GYHR2525M00-M25R	●	GYM25RD-H25-060	●	2		
			Modular	L	GYHL2525M00-M25L	●	GYM25LD-H25-060	●	2		
Modular	R	GYHR3225P00-M25R	●	GYM25RD-H25-060	●	6					
Modular	L	GYHL3225P00-M25L	●	GYM25LD-H25-060	●	6					
Modular	R	GYHR3232P00-M25R	●	GYM25RD-H25-060	●	6					
Modular	L	GYHL3232P00-M25L	●	GYM25LD-H25-060	●	6					

*1 Dimensions shown are when standard insert is used. If other insert geometries are used then LF, LH, LH2, and WF values may vary.
 *2 The maximum groove depth (CDX) varies according to the insert used. Please refer to the maximum groove depth (CDX) of inserts on pages F012—F015.

● : Inventory maintained.

GROOVING / CUTTING OFF

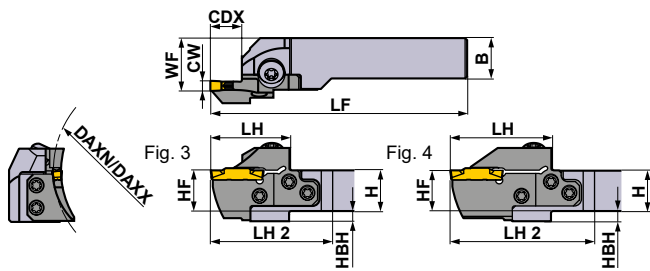

* Wrench : ① : Clamp Screw, ② : Blade Screw

SPARE PARTS			
Holder			
	Clamp Screw	Blade Screw 5 pcs.	Wrench *
GYHR/L2020K00-M25R/L	GY06013M (Clamp Torque : 6.0N·m)	TS55 (Clamp Torque : 5.0N·m)	①TKY30R ②TKY25D
GYHR/L2525M00-M25R/L			
GYHR/L3225P00-M25R/L			
GYHR/L3232P00-M25R/L			

Right hand tool holder shown.

	Dimensions (mm) *1								Cutting Mode
	H	B	LF	LH	LH 2	HF	WF	HBH	
	20	20	125	39	60	20	26	5	R
	20	20	125	39	60	20	26	5	
	25	25	150	39	57	25	28	—	R
	25	25	150	39	57	25	28	—	
	32	25	170	39	57	32	28	—	R
	32	25	170	39	57	32	28	—	
	32	32	170	39	57	32	35	—	R
	32	32	170	39	57	32	35	—	
	20	20	125	39	60	20	26	5	L
	20	20	125	39	60	20	26	5	
	25	25	150	39	57	25	28	—	L
	25	25	150	39	57	25	28	—	
	32	25	170	39	57	32	28	—	L
	32	25	170	39	57	32	28	—	
	32	32	170	39	57	32	35	—	L
	32	32	170	39	57	32	35	—	
	20	20	136	50	71	20	26	5	L
	20	20	136	50	71	20	26	5	
	25	25	161	50	68	25	28	—	L
	25	25	161	50	68	25	28	—	
	32	25	181	50	68	32	28	—	L
	32	25	181	50	68	32	28	—	
	32	32	181	50	68	32	35	—	L
	32	32	181	50	68	32	35	—	

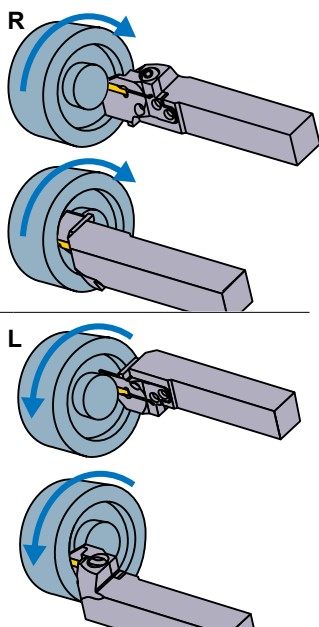

Insert selection

Seat Size	Geometry name
H	GY○○0475/0500/0524H○○○○○Breaker shown below

For grooving/cutting off breaker > F012, F013					
Seat Size	Breaker CW	GU	GS	GM	GFGS
		(For gummy steel)	(Low)	(Medium)	(Hardened steel)
H	4.75mm	●	●	●	●
	5.00mm	●	●	●	●

For multifunctional grooving breaker > F014, F015					
Seat Size	Breaker CW	MF	MS	MM	BM
		(Finish)	(Low)	(Medium)	(Copying)
H	4.75mm				●
	RE 0.2	●			
	RE 0.4	●			
	RE 0.8	●			
	5.00mm				●
	RE 0.2	●			
	RE 0.4	●	●	●	
	RE 0.8	●	●	●	
5.24mm	●				

● : Standard insert with dimensions

T
GROOVING / CUTTING OFF

IDENTIFICATION > F008, F009
CUTTING CONDITIONS > F104
CAUTION FOR USE > F106

GY SERIES (FACE GROOVING)

4

00° type holder

Insert	GY2M ^{GS} _{GM}	Insert	GY2G ^{MF}
Insert	GY2M ^{GU}	Insert	GY2M ^{MS}
Insert	GY1 ^M _G ^{GM} _{GFGS}	Insert	GY2M ^{MM}

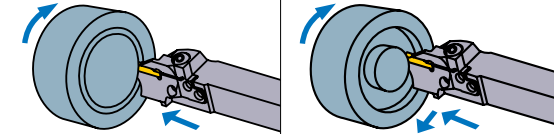

Insert GY2M^{BM}

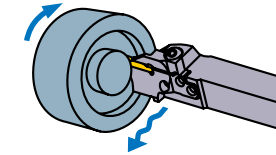

Note 1) For modular blades and modular holders, please order separately.
 Note 2) Please use right hand modular blade for right hand holder and left hand modular blade for left hand holder.

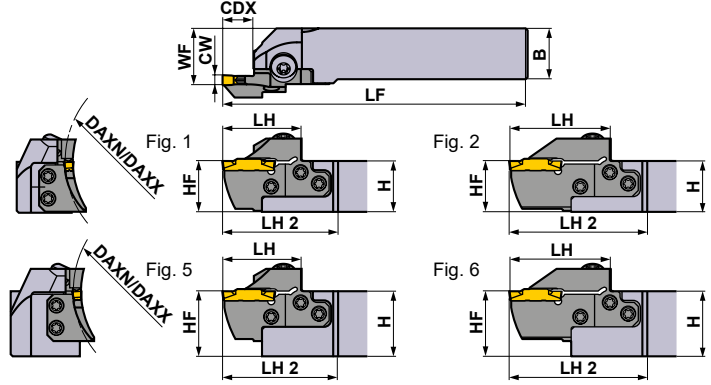

Right hand tool holder shown.

Seat Size	Dimensions (mm)				Type	Hand (R/L)	Order Number				Fig.
	CW	DAXN	DAXX	CDX			Holder	Stock	Modular Blade	Stock	
H	4.75 5.00 5.24	85	125	14	Modular	R	GYHR2020K00-M25R	●	GYM25RD-H14-085	●	3
					Modular	L	GYHL2020K00-M25L	●	GYM25LD-H14-085	●	3
					Modular	R	GYHR2525M00-M25R	●	GYM25RD-H14-085	●	1
					Modular	L	GYHL2525M00-M25L	●	GYM25LD-H14-085	●	1
					Modular	R	GYHR3225P00-M25R	●	GYM25RD-H14-085	●	5
					Modular	L	GYHL3225P00-M25L	●	GYM25LD-H14-085	●	5
		Modular	R	GYHR3232P00-M25R	●	GYM25RD-H14-085	●	5			
		Modular	L	GYHL3232P00-M25L	●	GYM25LD-H14-085	●	5			
		Modular	R	GYHR2020K00-M25R	●	GYM25RD-H25-085	●	4			
		Modular	L	GYHL2020K00-M25L	●	GYM25LD-H25-085	●	4			
		Modular	R	GYHR2525M00-M25R	●	GYM25RD-H25-085	●	2			
		Modular	L	GYHL2525M00-M25L	●	GYM25LD-H25-085	●	2			
	Modular	R	GYHR3225P00-M25R	●	GYM25RD-H25-085	●	6				
	Modular	L	GYHL3225P00-M25L	●	GYM25LD-H25-085	●	6				
	Modular	R	GYHR3232P00-M25R	●	GYM25RD-H25-085	●	6				
	Modular	L	GYHL3232P00-M25L	●	GYM25LD-H25-085	●	6				
	Modular	R	GYHR2020K00-M25R	●	GYM25RD-H14-125	●	3				
	Modular	L	GYHL2020K00-M25L	●	GYM25LD-H14-125	●	3				
	Modular	R	GYHR2525M00-M25R	●	GYM25RD-H14-125	●	1				
	Modular	L	GYHL2525M00-M25L	●	GYM25LD-H14-125	●	1				
	Modular	R	GYHR3225P00-M25R	●	GYM25RD-H14-125	●	5				
	Modular	L	GYHL3225P00-M25L	●	GYM25LD-H14-125	●	5				
	Modular	R	GYHR3232P00-M25R	●	GYM25RD-H14-125	●	5				
	Modular	L	GYHL3232P00-M25L	●	GYM25LD-H14-125	●	5				
Modular	R	GYHR2020K00-M25R	●	GYM25RD-H25-125	●	4					
Modular	L	GYHL2020K00-M25L	●	GYM25LD-H25-125	●	4					
Modular	R	GYHR2525M00-M25R	●	GYM25RD-H25-125	●	2					
Modular	L	GYHL2525M00-M25L	●	GYM25LD-H25-125	●	2					
Modular	R	GYHR3225P00-M25R	●	GYM25RD-H25-125	●	6					
Modular	L	GYHL3225P00-M25L	●	GYM25LD-H25-125	●	6					
Modular	R	GYHR3232P00-M25R	●	GYM25RD-H25-125	●	6					
Modular	L	GYHL3232P00-M25L	●	GYM25LD-H25-125	●	6					

*1 Dimensions shown are when standard insert is used. If other insert geometries are used then LF, LH, LH2, and WF values may vary.
 *2 The maximum groove depth (CDX) varies according to the insert used. Please refer to the maximum groove depth (CDX) of inserts on pages F012—F015.

● : Inventory maintained.

GROOVING / CUTTING OFF

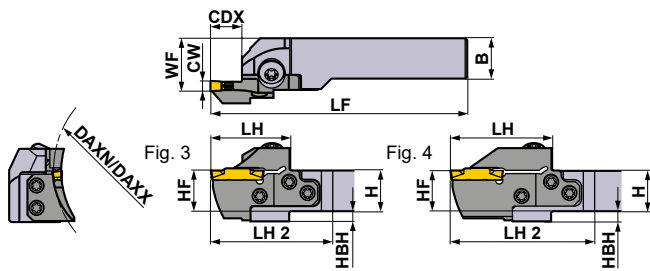

* Wrench : ① : Clamp Screw, ② : Blade Screw

SPARE PARTS			
Holder	Clamp Screw	Blade Screw 5 pcs.	Wrench *
GYHR/L2020K00-M25R/L	GY06013M (Clamp Torque : 6.0N·m)	TS55 (Clamp Torque : 5.0N·m)	①TKY30R ②TKY25D
GYHR/L2525M00-M25R/L			
GYHR/L3225P00-M25R/L			
GYHR/L3232P00-M25R/L			

Right hand tool holder shown.

Dimensions (mm) *1									Cutting Mode
H	B	LF	LH	LH 2	HF	WF	HBH		
20	20	125	39	60	20	26	5	R	
20	20	125	39	60	20	26	5		
25	25	150	39	57	25	28	—		
25	25	150	39	57	25	28	—		
32	25	170	39	57	32	28	—		
32	25	170	39	57	32	28	—		
32	32	170	39	57	32	35	—		
32	32	170	39	57	32	35	—		
20	20	136	50	71	20	26	5		
20	20	136	50	71	20	26	5		
25	25	161	50	68	25	28	—		
25	25	161	50	68	25	28	—		
32	25	181	50	68	32	28	—		
32	25	181	50	68	32	28	—		
32	32	181	50	68	32	35	—		
32	32	181	50	68	32	35	—		
20	20	125	39	60	20	26	5		
20	20	125	39	60	20	26	5		
25	25	150	39	57	25	28	—		
25	25	150	39	57	25	28	—		
32	25	170	39	57	32	28	—		
32	25	170	39	57	32	28	—		
32	32	170	39	57	32	35	—		
32	32	170	39	57	32	35	—		
20	20	136	50	71	20	26	5		
20	20	136	50	71	20	26	5		
25	25	161	50	68	25	28	—		
25	25	161	50	68	25	28	—		
32	25	181	50	68	32	28	—		
32	25	181	50	68	32	28	—		
32	32	181	50	68	32	35	—		
32	32	181	50	68	32	35	—		

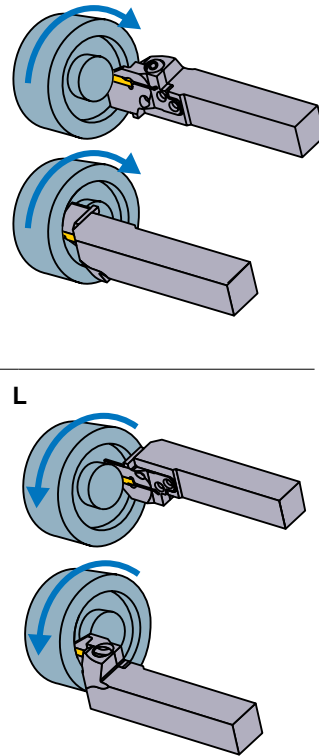

Insert selection

Seat Size	Geometry name
H	GY○○0475/0500/0524H○○○○○Breaker shown below

For grooving/cutting off breaker > F012, F013					
Seat Size	Breaker	GU (For gummy steel)	GS (Low)	GM (Medium)	GFGS (Hardened steel)
H	CW				
	H	4.75mm	●	●	●
		5.00mm	●	●	●

For multifunctional grooving breaker > F014, F015					
Seat Size	Breaker	MF (Finish)	MS (Low)	MM (Medium)	BM (Copying) Ball shape
H	CW	4.75mm			●
		RE 0.2	●		
		RE 0.4	●		
		RE 0.8	●		
	5.00mm	RE 0.2	●		
		RE 0.4	●	●	●
		RE 0.8	●	●	●
		5.24mm	●		

● : Standard insert with dimensions

IDENTIFICATION > F008, F009
CUTTING CONDITIONS > F104
CAUTION FOR USE > F106

GY SERIES (FACE GROOVING)

4

00° type holder

Insert	GY2M ^{GS} _{GM}	Insert	GY2G ^{MF}
Insert	GY2M ^{GU}	Insert	GY2M ^{MS}
Insert	GY1 ^{GM} _{GFGS}	Insert	GY2M ^{MM}

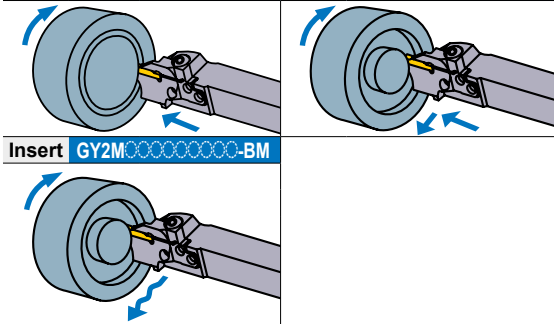

Note 1) For modular blades and modular holders, please order separately.
 Note 2) Please use right hand modular blade for right hand holder and left hand modular blade for left hand holder.

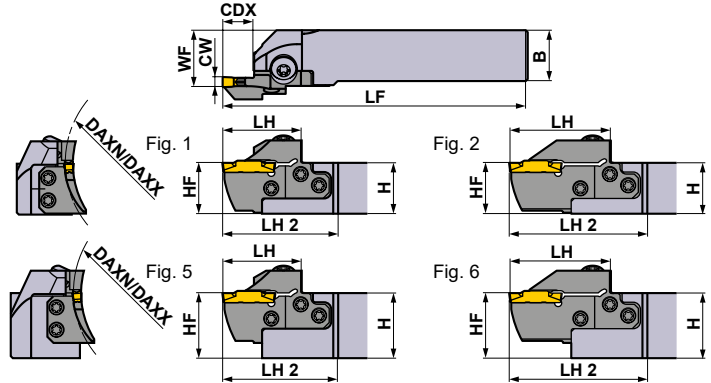

Right hand tool holder shown.

Seat Size	Dimensions (mm)				Type	Hand (R/L)	Order Number				Fig.
	CW	DAXN	DAXX	CDX			Holder	Stock	Modular Blade	Stock	
H	4.75 5.00 5.24	180	280	14	Modular	R	GYHR2020K00-M25R	●	GYM25RD-H14-180	●	3
					Modular	L	GYHL2020K00-M25L	●	GYM25LD-H14-180	●	3
					Modular	R	GYHR2525M00-M25R	●	GYM25RD-H14-180	●	1
					Modular	L	GYHL2525M00-M25L	●	GYM25LD-H14-180	●	1
				Modular	R	GYHR3225P00-M25R	●	GYM25RD-H14-180	●	5	
				Modular	L	GYHL3225P00-M25L	●	GYM25LD-H14-180	●	5	
				Modular	R	GYHR3232P00-M25R	●	GYM25RD-H14-180	●	5	
				Modular	L	GYHL3232P00-M25L	●	GYM25LD-H14-180	●	5	
	25 *2	Modular	R	GYHR2020K00-M25R	●	GYM25RD-H25-180	●	4			
		Modular	L	GYHL2020K00-M25L	●	GYM25LD-H25-180	●	4			
		Modular	R	GYHR2525M00-M25R	●	GYM25RD-H25-180	●	2			
		Modular	L	GYHL2525M00-M25L	●	GYM25LD-H25-180	●	2			
	250	999	14	Modular	R	GYHR3225P00-M25R	●	GYM25RD-H25-180	●	6	
				Modular	L	GYHL3225P00-M25L	●	GYM25LD-H25-180	●	6	
				Modular	R	GYHR3232P00-M25R	●	GYM25RD-H25-180	●	6	
				Modular	L	GYHL3232P00-M25L	●	GYM25LD-H25-180	●	6	
25 *2			Modular	R	GYHR2020K00-M25R	●	GYM25RD-H25-250	●	4		
			Modular	L	GYHL2020K00-M25L	●	GYM25LD-H25-250	●	4		
			Modular	R	GYHR2525M00-M25R	●	GYM25RD-H25-250	●	2		
			Modular	L	GYHL2525M00-M25L	●	GYM25LD-H25-250	●	2		
Modular	R	GYHR3225P00-M25R	●	GYM25RD-H25-250	●	6					
Modular	L	GYHL3225P00-M25L	●	GYM25LD-H25-250	●	6					
Modular	R	GYHR3232P00-M25R	●	GYM25RD-H25-250	●	6					
Modular	L	GYHL3232P00-M25L	●	GYM25LD-H25-250	●	6					

*1 Dimensions shown are when standard insert is used. If other insert geometries are used then LF, LH, LH2, and WF values may vary.
 *2 The maximum groove depth (CDX) varies according to the insert used. Please refer to the maximum groove depth (CDX) of inserts on pages F012—F015.

● : Inventory maintained.

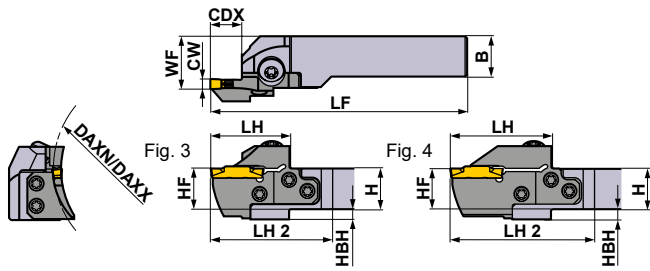

* Wrench : ① : Clamp Screw, ② : Blade Screw

SPARE PARTS			
Holder	Clamp Screw	Blade Screw 5 pcs.	Wrench *
GYHR/L2020K00-M25R/L	GY06013M (Clamp Torque : 6.0N·m)	TS55 (Clamp Torque : 5.0N·m)	①TKY30R ②TKY25D
GYHR/L2525M00-M25R/L			
GYHR/L3225P00-M25R/L			
GYHR/L3232P00-M25R/L			

Right hand tool holder shown.

Dimensions (mm) *1									Cutting Mode
H	B	LF	LH	LH 2	HF	WF	HBH		
20	20	125	39	60	20	26	5	R	
20	20	125	39	60	20	26	5		
25	25	150	39	57	25	28	—		
25	25	150	39	57	25	28	—		
32	25	170	39	57	32	28	—		
32	25	170	39	57	32	28	—		
32	32	170	39	57	32	35	—		
32	32	170	39	57	32	35	—		
20	20	136	50	71	20	26	5		
20	20	136	50	71	20	26	5		
25	25	161	50	68	25	28	—		
25	25	161	50	68	25	28	—		
32	25	181	50	68	32	28	—		
32	25	181	50	68	32	28	—		
32	32	181	50	68	32	35	—		
32	32	181	50	68	32	35	—		
20	20	125	39	60	20	26	5		
20	20	125	39	60	20	26	5		
25	25	150	39	57	25	28	—		
25	25	150	39	57	25	28	—		
32	25	170	39	57	32	28	—		
32	25	170	39	57	32	28	—		
32	32	170	39	57	32	35	—		
32	32	170	39	57	32	35	—		
20	20	136	50	71	20	26	5		
20	20	136	50	71	20	26	5		
25	25	161	50	68	25	28	—		
25	25	161	50	68	25	28	—		
32	25	181	50	68	32	28	—		
32	25	181	50	68	32	28	—		
32	32	181	50	68	32	35	—		
32	32	181	50	68	32	35	—		

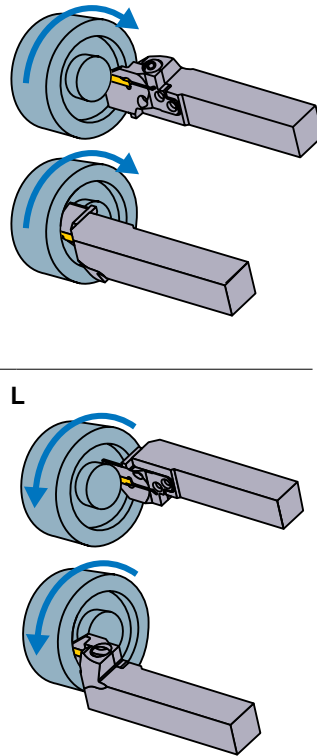

Insert selection

Seat Size	Geometry name
H	GY○○0475/0500/0524H○○○○○Breaker shown below

For grooving/cutting off breaker > F012, F013					
Seat Size	Breaker	GU	GS	GM	GFGS
		(For gummy steel)	(Low)	(Medium)	(Hardened steel)
H	4.75mm	●	●	●	●
	5.00mm	●	●	●	●

For multifunctional grooving breaker > F014, F015					
Seat Size	Breaker	MF	MS	MM	BM
		(Finish)	(Low)	(Medium)	(Copying)
H	4.75mm				●
	RE 0.2	●			
	RE 0.4	●			
	RE 0.8	●			
	5.00mm				●
	RE 0.2	●			
	RE 0.4	●	●	●	
	RE 0.8	●	●	●	
	5.24mm	●			

● : Standard insert with dimensions

IDENTIFICATION > F008, F009
CUTTING CONDITIONS > F104
CAUTION FOR USE > F106

GY SERIES (FACE GROOVING)

4

00° type holder

Insert	GY2M ^{GS} _{GM}	Insert	GY2G ^{MF}
Insert	GY2M ^{GU}	Insert	GY2M ^{MS}
Insert	GY1G ^{GFGS}	Insert	GY2M ^{MM}

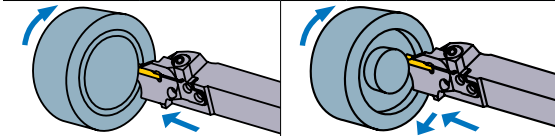

Insert GY2M^{BM}

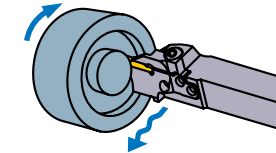

Note 1) For modular blades and modular holders, please order separately.

Note 2) Please use right hand modular blade for right hand holder and left hand modular blade for left hand holder.

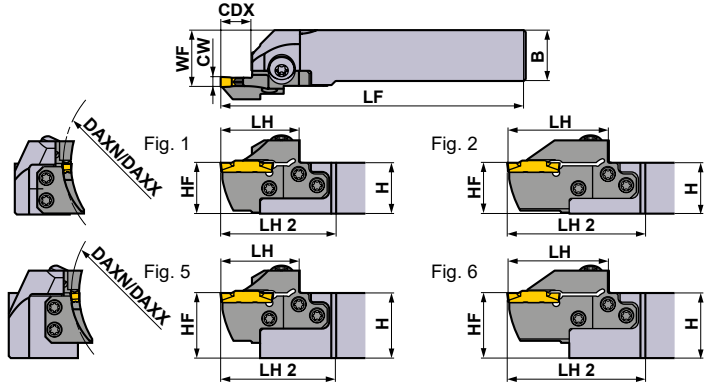

Right hand tool holder shown.

Seat Size	Dimensions (mm)				Type	Hand (R/L)	Order Number				Fig.
	CW	DAXN	DAXX	CDX			Holder	Stock	Modular Blade	Stock	
J	6.00 6.31 6.35	50	70	14	Modular	R	GYHR2020K00-M25R	●	GYM25RD-J14-050	●	3
					Modular	L	GYHL2020K00-M25L	●	GYM25LD-J14-050	●	3
					Modular	R	GYHR2525M00-M25R	●	GYM25RD-J14-050	●	1
					Modular	L	GYHL2525M00-M25L	●	GYM25LD-J14-050	●	1
		Modular	R	GYHR3225P00-M25R	●	GYM25RD-J14-050	●	5			
		Modular	L	GYHL3225P00-M25L	●	GYM25LD-J14-050	●	5			
		Modular	R	GYHR3232P00-M25R	●	GYM25RD-J14-050	●	5			
		Modular	L	GYHL3232P00-M25L	●	GYM25LD-J14-050	●	5			
		Modular	R	GYHR2020K00-M25R	●	GYM25RD-J14-070	●	3			
		Modular	L	GYHL2020K00-M25L	●	GYM25LD-J14-070	●	3			
		Modular	R	GYHR2525M00-M25R	●	GYM25RD-J14-070	●	1			
		Modular	L	GYHL2525M00-M25L	●	GYM25LD-J14-070	●	1			
	Modular	R	GYHR3225P00-M25R	●	GYM25RD-J14-070	●	5				
	Modular	L	GYHL3225P00-M25L	●	GYM25LD-J14-070	●	5				
	Modular	R	GYHR3232P00-M25R	●	GYM25RD-J14-070	●	5				
	Modular	L	GYHL3232P00-M25L	●	GYM25LD-J14-070	●	5				
	Modular	R	GYHR2020K00-M25R	●	GYM25RD-J25-070	●	4				
	Modular	L	GYHL2020K00-M25L	●	GYM25LD-J25-070	●	4				
	Modular	R	GYHR2525M00-M25R	●	GYM25RD-J25-070	●	2				
	Modular	L	GYHL2525M00-M25L	●	GYM25LD-J25-070	●	2				
	Modular	R	GYHR3225P00-M25R	●	GYM25RD-J25-070	●	6				
	Modular	L	GYHL3225P00-M25L	●	GYM25LD-J25-070	●	6				
	Modular	R	GYHR3232P00-M25R	●	GYM25RD-J25-070	●	6				
	Modular	L	GYHL3232P00-M25L	●	GYM25LD-J25-070	●	6				
Modular	R	GYHR2020K00-M25R	●	GYM25RD-J14-110	●	3					
Modular	L	GYHL2020K00-M25L	●	GYM25LD-J14-110	●	3					
Modular	R	GYHR2525M00-M25R	●	GYM25RD-J14-110	●	1					
Modular	L	GYHL2525M00-M25L	●	GYM25LD-J14-110	●	1					
Modular	R	GYHR3225P00-M25R	●	GYM25RD-J14-110	●	5					
Modular	L	GYHL3225P00-M25L	●	GYM25LD-J14-110	●	5					
Modular	R	GYHR3232P00-M25R	●	GYM25RD-J14-110	●	5					
Modular	L	GYHL3232P00-M25L	●	GYM25LD-J14-110	●	5					
Modular	R	GYHR2020K00-M25R	●	GYM25RD-J25-110	●	4					
Modular	L	GYHL2020K00-M25L	●	GYM25LD-J25-110	●	4					
Modular	R	GYHR2525M00-M25R	●	GYM25RD-J25-110	●	2					
Modular	L	GYHL2525M00-M25L	●	GYM25LD-J25-110	●	2					
Modular	R	GYHR3225P00-M25R	●	GYM25RD-J25-110	●	6					
Modular	L	GYHL3225P00-M25L	●	GYM25LD-J25-110	●	6					
Modular	R	GYHR3232P00-M25R	●	GYM25RD-J25-110	●	6					
Modular	L	GYHL3232P00-M25L	●	GYM25LD-J25-110	●	6					

*1 Dimensions shown are when standard insert is used. If other insert geometries are used then LF, LH, LH2, and WF values may vary.

*2 The maximum groove depth (CDX) varies according to the insert used. Please refer to the maximum groove depth (CDX) of inserts on pages F012—F015.

● : Inventory maintained.

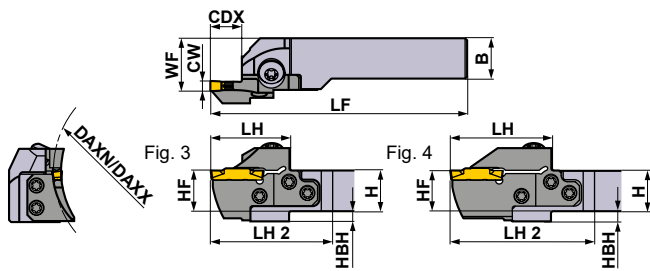

* Wrench : ① : Clamp Screw, ② : Blade Screw

SPARE PARTS			
Holder		5 pcs.	① ②
	Clamp Screw	Blade Screw	Wrench *
GYHR/L2020K00-M25R/L			
GYHR/L2525M00-M25R/L	GY06013M (Clamp Torque : 6.0N·m)	TS55 (Clamp Torque : 5.0N·m)	①TKY30R ②TKY25D
GYHR/L3225P00-M25R/L			
GYHR/L3232P00-M25R/L			

Right hand tool holder shown.

	Dimensions (mm) *1								Cutting Mode
	H	B	LF	LH	LH 2	HF	WF	HBH	
	20	20	125	39	60	20	26	5	R
	20	20	125	39	60	20	26	5	
	25	25	150	39	57	25	28	—	
	25	25	150	39	57	25	28	—	
	32	25	170	39	57	32	28	—	
	32	25	170	39	57	32	28	—	
	32	32	170	39	57	32	35	—	
	32	32	170	39	57	32	35	—	
	20	20	125	39	60	20	26	5	
	20	20	125	39	60	20	26	5	
	25	25	150	39	57	25	28	—	
	25	25	150	39	57	25	28	—	
	32	25	170	39	57	32	28	—	
	32	25	170	39	57	32	28	—	
	32	32	170	39	57	32	35	—	
	32	32	170	39	57	32	35	—	
	20	20	136	50	71	20	26	5	
	20	20	136	50	71	20	26	5	
	25	25	161	50	68	25	28	—	
	25	25	161	50	68	25	28	—	
	32	25	181	50	68	32	28	—	
	32	25	181	50	68	32	28	—	
	32	32	181	50	68	32	35	—	
	32	32	181	50	68	32	35	—	
	20	20	125	39	60	20	26	5	
	20	20	125	39	60	20	26	5	
	25	25	150	39	57	25	28	—	
	25	25	150	39	57	25	28	—	
	32	25	170	39	57	32	28	—	
	32	25	170	39	57	32	28	—	
	32	32	170	39	57	32	35	—	
	32	32	170	39	57	32	35	—	
	20	20	136	50	71	20	26	5	
	20	20	136	50	71	20	26	5	
	25	25	161	50	68	25	28	—	
	25	25	161	50	68	25	28	—	
	32	25	181	50	68	32	28	—	
	32	25	181	50	68	32	28	—	
	32	32	181	50	68	32	35	—	
	32	32	181	50	68	32	35	—	

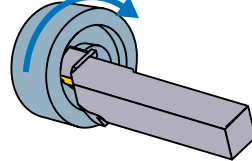
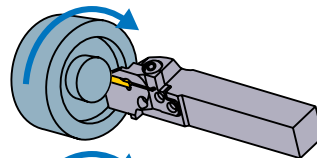

L

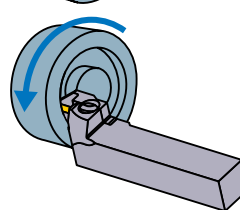
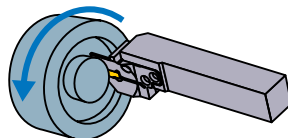

Insert selection

Seat Size	Geometry name
J	GY○○0600/0631/0635J○○○○○-Breaker shown below

For grooving/cutting off breaker > F012, F013					
Seat Size	Breaker CW	GU	GS	GM	GFGS
		(For gummy steel)	(Low)	(Medium)	(Hardened steel)
J	6.00mm	●	●	●	●
J	6.35mm	●	●	●	●

For multifunctional grooving breaker > F014, F015					
Seat Size	Breaker CW	MF	MS	MM	BM
		(Finish)	(Low)	(Medium)	(Copying)
J	6.00mm				●
	RE 0.2	●			
	RE 0.4	●	●	●	
	RE 0.8	●	●	●	
	6.31mm	●			
	6.35mm				●
	RE 0.2	●			
	RE 0.4	●			
RE 0.8	●				

● : Standard insert with dimensions

IDENTIFICATION > F008, F009
 CUTTING CONDITIONS > F104
 CAUTION FOR USE > F106

GY SERIES (FACE GROOVING)

4

00° type holder

Insert	GY2M ^{GS} _{GM}	Insert	GY2G ^{MF}
Insert	GY2M ^{GU}	Insert	GY2M ^{MS}
Insert	GY1G ^{GFGS}	Insert	GY2M ^{MM}

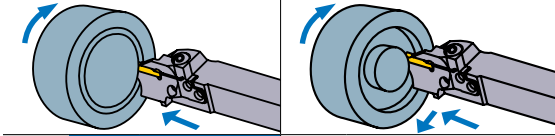

Insert GY2M^{BM}

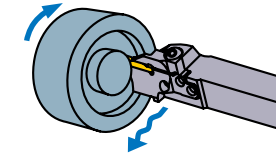

Note 1) For modular blades and modular holders, please order separately.

Note 2) Please use right hand modular blade for right hand holder and left hand modular blade for left hand holder.

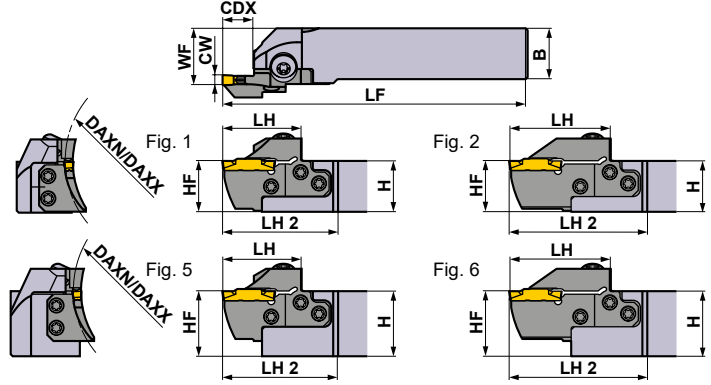

Right hand tool holder shown.

Seat Size	Dimensions (mm)				Type	Hand (R/L)	Order Number				Fig.
	CW	DAXN	DAXX	CDX			Holder	Stock	Modular Blade	Stock	
J	6.00 6.31 6.35	170	280	14	Modular	R	GYHR2020K00-M25R	●	GYM25RD-J14-170	●	3
					Modular	L	GYHL2020K00-M25L	●	GYM25LD-J14-170	●	3
					Modular	R	GYHR2525M00-M25R	●	GYM25RD-J14-170	●	1
					Modular	L	GYHL2525M00-M25L	●	GYM25LD-J14-170	●	1
				Modular	R	GYHR3225P00-M25R	●	GYM25RD-J14-170	●	5	
				Modular	L	GYHL3225P00-M25L	●	GYM25LD-J14-170	●	5	
				Modular	R	GYHR3232P00-M25R	●	GYM25RD-J14-170	●	5	
				Modular	L	GYHL3232P00-M25L	●	GYM25LD-J14-170	●	5	
	25 *2	Modular	R	GYHR2020K00-M25R	●	GYM25RD-J25-170	●	4			
		Modular	L	GYHL2020K00-M25L	●	GYM25LD-J25-170	●	4			
		Modular	R	GYHR2525M00-M25R	●	GYM25RD-J25-170	●	2			
		Modular	L	GYHL2525M00-M25L	●	GYM25LD-J25-170	●	2			
		Modular	R	GYHR3225P00-M25R	●	GYM25RD-J25-170	●	6			
		Modular	L	GYHL3225P00-M25L	●	GYM25LD-J25-170	●	6			
		Modular	R	GYHR3232P00-M25R	●	GYM25RD-J25-170	●	6			
		Modular	L	GYHL3232P00-M25L	●	GYM25LD-J25-170	●	6			
250	999	14	Modular	R	GYHR2020K00-M25R	●	GYM25RD-J14-250	●	3		
			Modular	L	GYHL2020K00-M25L	●	GYM25LD-J14-250	●	3		
			Modular	R	GYHR2525M00-M25R	●	GYM25RD-J14-250	●	1		
			Modular	L	GYHL2525M00-M25L	●	GYM25LD-J14-250	●	1		
		Modular	R	GYHR3225P00-M25R	●	GYM25RD-J14-250	●	5			
		Modular	L	GYHL3225P00-M25L	●	GYM25LD-J14-250	●	5			
		Modular	R	GYHR3232P00-M25R	●	GYM25RD-J14-250	●	5			
		Modular	L	GYHL3232P00-M25L	●	GYM25LD-J14-250	●	5			
25 *2	Modular	R	GYHR2020K00-M25R	●	GYM25RD-J25-250	●	4				
	Modular	L	GYHL2020K00-M25L	●	GYM25LD-J25-250	●	4				
	Modular	R	GYHR2525M00-M25R	●	GYM25RD-J25-250	●	2				
	Modular	L	GYHL2525M00-M25L	●	GYM25LD-J25-250	●	2				
Modular	R	GYHR3225P00-M25R	●	GYM25RD-J25-250	●	6					
Modular	L	GYHL3225P00-M25L	●	GYM25LD-J25-250	●	6					
Modular	R	GYHR3232P00-M25R	●	GYM25RD-J25-250	●	6					
Modular	L	GYHL3232P00-M25L	●	GYM25LD-J25-250	●	6					

*1 Dimensions shown are when standard insert is used. If other insert geometries are used then LF, LH, LH2, and WF values may vary.

*2 The maximum groove depth (CDX) varies according to the insert used. Please refer to the maximum groove depth (CDX) of inserts on pages F012—F015.

● : Inventory maintained.

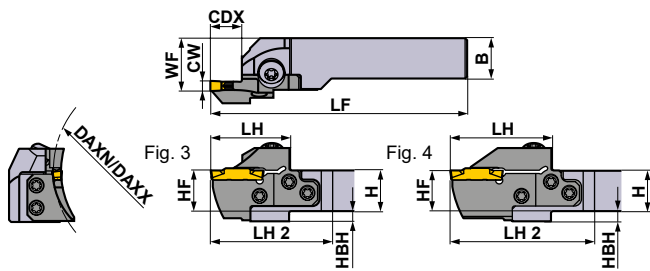

* Wrench : ① : Clamp Screw, ② : Blade Screw

SPARE PARTS			
Holder	Clamp Screw	Blade Screw 5 pcs.	Wrench *
GYHR/L2020K00-M25R/L	GY06013M (Clamp Torque : 6.0N·m)	TS55 (Clamp Torque : 5.0N·m)	①TKY30R ②TKY25D
GYHR/L2525M00-M25R/L			
GYHR/L3225P00-M25R/L			
GYHR/L3232P00-M25R/L			

Right hand tool holder shown.

Dimensions (mm) *1									Cutting Mode
H	B	LF	LH	LH 2	HF	WF	HBH		
20	20	125	39	60	20	26	5	R	
20	20	125	39	60	20	26	5		
25	25	150	39	57	25	28	—	R	
25	25	150	39	57	25	28	—		
32	25	170	39	57	32	28	—		
32	25	170	39	57	32	28	—		
32	32	170	39	57	32	35	—		
32	32	170	39	57	32	35	—		
20	20	136	50	71	20	26	5	L	
20	20	136	50	71	20	26	5		
25	25	161	50	68	25	28	—		
25	25	161	50	68	25	28	—		
32	25	181	50	68	32	28	—		
32	25	181	50	68	32	28	—		
32	32	181	50	68	32	35	—		
32	32	181	50	68	32	35	—		
20	20	125	39	60	20	26	5		
20	20	125	39	60	20	26	5		
25	25	150	39	57	25	28	—		
25	25	150	39	57	25	28	—		
32	25	170	39	57	32	28	—		
32	25	170	39	57	32	28	—		
32	32	170	39	57	32	35	—		
32	32	170	39	57	32	35	—		
20	20	136	50	71	20	26	5		
20	20	136	50	71	20	26	5		
25	25	161	50	68	25	28	—		
25	25	161	50	68	25	28	—		
32	25	181	50	68	32	28	—		
32	25	181	50	68	32	28	—		
32	32	181	50	68	32	35	—		
32	32	181	50	68	32	35	—		

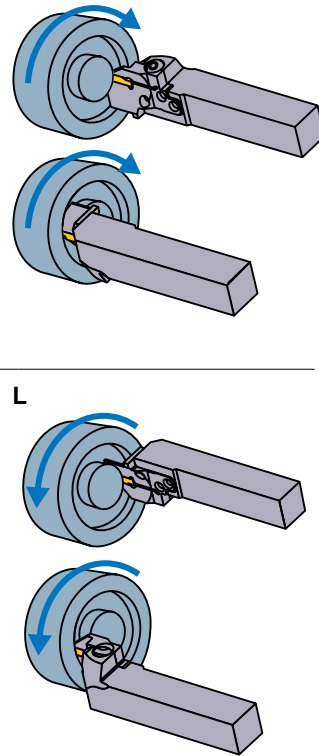

Insert selection

Seat Size	Geometry name
J	GY○○0600/0631/0635J○○○○-Breaker shown below

For grooving/cutting off breaker > F012, F013					
Seat Size	Breaker	GU (For gummy steel)	GS (Low)	GM (Medium)	GFGS (Hardened steel)
J	6.00mm	●	●	●	●
	6.35mm	●	●	●	●

For multifunctional grooving breaker > F014, F015					
Seat Size	Breaker	MF (Finish)	MS (Low)	MM (Medium)	BM (Copying) Ball shape
J	6.00mm				●
	RE 0.2	●			
	RE 0.4	●	●		
	RE 0.8	●	●	●	
	6.31mm	●			
	6.35mm	●			●
	RE 0.2	●			
	RE 0.4	●			
RE 0.8	●				

● : Standard insert with dimensions

IDENTIFICATION > F008, F009
CUTTING CONDITIONS > F104
CAUTION FOR USE > F106

GY SERIES (FACE GROOVING)

5

90° type holder

Note 1) For modular blades and modular holders, please order separately.

Note 2) Please use left hand modular blade for right hand holder and right hand modular blade for left hand holder.

Insert	GY2M ^{GS} _{GM}	Insert	GY2G ^{MF}
Insert	GY2M ^{GU}	Insert	GY2M ^{MS}
Insert	GY1 ^{GM} _{GFGS}	Insert	GY2M ^{MM}

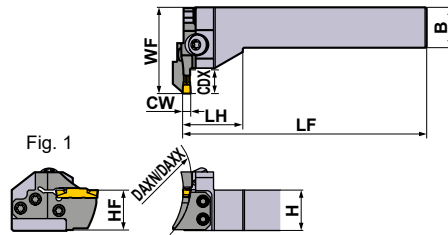
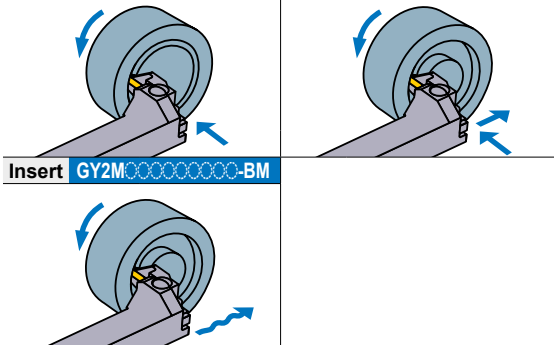

Right hand tool holder shown.

Seat Size	Dimensions (mm)				Type	Hand (R/L)	Order Number				Fig.
	CW	DAXN	DAXX	CDX			Holder	Stock	Modular Blade	Stock	
D	2.00 2.24	40	50	12	Modular	R L	GYHR2525M90-M25L GYHL2525M90-M25R	● ●	GYM25LD-D12-040 GYM25RD-D12-040	● ●	1 1
		50	60	12	Modular	R L	GYHR2525M90-M25L GYHL2525M90-M25R	● ●	GYM25LD-D12-050 GYM25RD-D12-050	● ●	1 1
		60	75	12	Modular	R L	GYHR2525M90-M25L GYHL2525M90-M25R	● ●	GYM25LD-D12-060 GYM25RD-D12-060	● ●	1 1
		75	100	12	Modular	R L	GYHR2525M90-M25L GYHL2525M90-M25R	● ●	GYM25LD-D12-075 GYM25RD-D12-075	● ●	1 1
		100	150	12	Modular	R L	GYHR2525M90-M25L GYHL2525M90-M25R	● ●	GYM25LD-D12-100 GYM25RD-D12-100	● ●	1 1
		135	200	12	Modular	R L	GYHR2525M90-M25L GYHL2525M90-M25R	● ●	GYM25LD-D12-135 GYM25RD-D12-135	● ●	1 1
		180	250	12	Modular	R L	GYHR2525M90-M25L GYHL2525M90-M25R	● ●	GYM25LD-D12-180 GYM25RD-D12-180	● ●	1 1
E	2.39 2.50 2.74	40	50	12	Modular	R L	GYHR2525M90-M25L GYHL2525M90-M25R	● ●	GYM25LD-E12-040 GYM25RD-E12-040	● ●	1 1
		50	60	12	Modular	R L	GYHR2525M90-M25L GYHL2525M90-M25R	● ●	GYM25LD-E12-050 GYM25RD-E12-050	● ●	1 1
		60	75	12	Modular	R L	GYHR2525M90-M25L GYHL2525M90-M25R	● ●	GYM25LD-E12-060 GYM25RD-E12-060	● ●	1 1
		75	100	12	Modular	R L	GYHR2525M90-M25L GYHL2525M90-M25R	● ●	GYM25LD-E12-075 GYM25RD-E12-075	● ●	1 1
		100	150	12	Modular	R L	GYHR2525M90-M25L GYHL2525M90-M25R	● ●	GYM25LD-E12-100 GYM25RD-E12-100	● ●	1 1
		135	200	12	Modular	R L	GYHR2525M90-M25L GYHL2525M90-M25R	● ●	GYM25LD-E12-135 GYM25RD-E12-135	● ●	1 1
		180	250	12	Modular	R L	GYHR2525M90-M25L GYHL2525M90-M25R	● ●	GYM25LD-E12-180 GYM25RD-E12-180	● ●	1 1

*1 Dimensions shown are when standard insert is used. If other insert geometries are used then LF, LH and WF values may vary.

● : Inventory maintained.

GY SERIES (FACE GROOVING)

5

90° type holder

Note 1) For modular blades and modular holders, please order separately.

Note 2) Please use left hand modular blade for right hand holder and right hand modular blade for left hand holder.

Insert	GY2M ^{GS} _{GM}	Insert	GY2G ^{MF}
Insert	GY2M ^{GU}	Insert	GY2M ^{MS}
Insert	GY1 ^{GM} _{GFGS}	Insert	GY2M ^{MM}

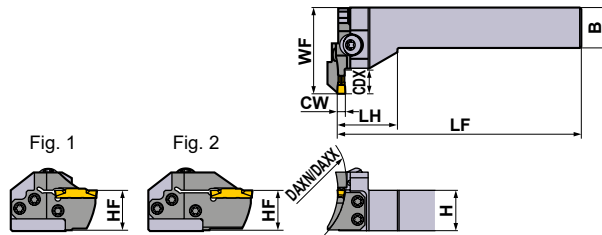
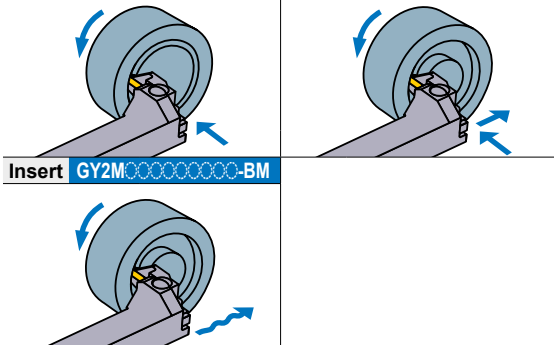

Right hand tool holder shown.

Seat Size	Dimensions (mm)			Type	Hand (R/L)	Order Number				Fig.	
	CW	DAXN	DAXX			CDX	Holder	Stock	Modular Blade		Stock
F	3.00 3.18 3.24	35	40	12	Modular	R	GYHR2525M90-M25L	●	GYM25LD-F12-035	●	1
				L	GYHL2525M90-M25R	●	GYM25RD-F12-035	●	1		
		40	50	12	Modular	R	GYHR2525M90-M25L	●	GYM25LD-F12-040	●	1
				L	GYHL2525M90-M25R	●	GYM25RD-F12-040	●	1		
		50	60	12	Modular	R	GYHR2525M90-M25L	●	GYM25LD-F12-050	●	1
				L	GYHL2525M90-M25R	●	GYM25RD-F12-050	●	1		
		60	75	12	Modular	R	GYHR2525M90-M25L	●	GYM25LD-F12-060	●	1
				L	GYHL2525M90-M25R	●	GYM25RD-F12-060	●	1		
				20 *2	Modular	R	GYHR2525M90-M25L	●	GYM25LD-F20-060	●	2
				L	GYHL2525M90-M25R	●	GYM25RD-F20-060	●	2		
		75	100	12	Modular	R	GYHR2525M90-M25L	●	GYM25LD-F12-075	●	1
				L	GYHL2525M90-M25R	●	GYM25RD-F12-075	●	1		
				20 *2	Modular	R	GYHR2525M90-M25L	●	GYM25LD-F20-075	●	2
				L	GYHL2525M90-M25R	●	GYM25RD-F20-075	●	2		
		100	150	12	Modular	R	GYHR2525M90-M25L	●	GYM25LD-F12-100	●	1
				L	GYHL2525M90-M25R	●	GYM25RD-F12-100	●	1		
				20 *2	Modular	R	GYHR2525M90-M25L	●	GYM25LD-F20-100	●	2
				L	GYHL2525M90-M25R	●	GYM25RD-F20-100	●	2		
135	200	12	Modular	R	GYHR2525M90-M25L	●	GYM25LD-F12-135	●	1		
		L	GYHL2525M90-M25R	●	GYM25RD-F12-135	●	1				
		20 *2	Modular	R	GYHR2525M90-M25L	●	GYM25LD-F20-135	●	2		
		L	GYHL2525M90-M25R	●	GYM25RD-F20-135	●	2				
180	250	12	Modular	R	GYHR2525M90-M25L	●	GYM25LD-F12-180	●	1		
		L	GYHL2525M90-M25R	●	GYM25RD-F12-180	●	1				
		20 *2	Modular	R	GYHR2525M90-M25L	●	GYM25LD-F20-180	●	2		
		L	GYHL2525M90-M25R	●	GYM25RD-F20-180	●	2				
225	999	12	Modular	R	GYHR2525M90-M25L	●	GYM25LD-F12-225	●	1		
		L	GYHL2525M90-M25R	●	GYM25RD-F12-225	●	1				
		20 *2	Modular	R	GYHR2525M90-M25L	●	GYM25LD-F20-225	●	2		
		L	GYHL2525M90-M25R	●	GYM25RD-F20-225	●	2				

*1 Dimensions shown are when standard insert is used. If other insert geometries are used then LF, LH and WF values may vary.

*2 The maximum groove depth (CDX) varies according to the insert used. Please refer to the maximum groove depth (CDX) of inserts on pages F012–F015.

● : Inventory maintained.

GY SERIES (FACE GROOVING)

5

90° type holder

Note 1) For modular blades and modular holders, please order separately.

Note 2) Please use left hand modular blade for right hand holder and right hand modular blade for left hand holder.

Insert	GY2M ^{GS} _{GM}	Insert	GY2G ^{MF}
Insert	GY2M ^{GU}	Insert	GY2M ^{MS}
Insert	GY1 ^{GM} _{GFGS}	Insert	GY2M ^{MM}

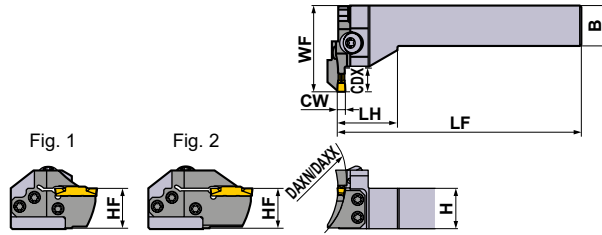
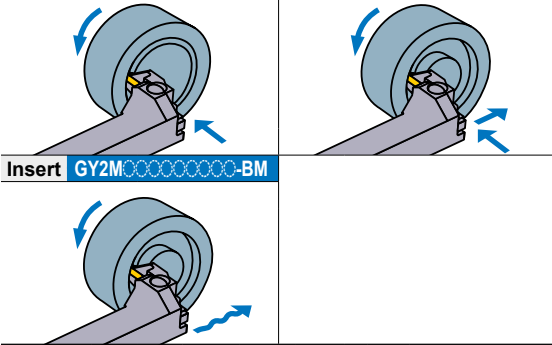

Right hand tool holder shown.



Seat Size	Dimensions (mm)				Type	Hand (R/L)	Order Number				Fig.
	CW	DAXN	DAXX	CDX			Holder	Stock	Modular Blade	Stock	
G	4.00 4.24	40	50	14	Modular	R	GYHR2525M90-M25L	●	GYM25LD-G14-040	●	1
				L	GYHL2525M90-M25R	●	GYM25RD-G14-040	●	1		
		50	60	14	Modular	R	GYHR2525M90-M25L	●	GYM25LD-G14-050	●	1
				L	GYHL2525M90-M25R	●	GYM25RD-G14-050	●	1		
		60	85	14	Modular	R	GYHR2525M90-M25L	●	GYM25LD-G14-060	●	1
				L	GYHL2525M90-M25R	●	GYM25RD-G14-060	●	1		
		25 *2			Modular	R	GYHR2525M90-M25L	●	GYM25LD-G25-060	●	2
					L	GYHL2525M90-M25R	●	GYM25RD-G25-060	●	2	
		85	125	14	Modular	R	GYHR2525M90-M25L	●	GYM25LD-G14-085	●	1
				L	GYHL2525M90-M25R	●	GYM25RD-G14-085	●	1		
		25 *2			Modular	R	GYHR2525M90-M25L	●	GYM25LD-G25-085	●	2
					L	GYHL2525M90-M25R	●	GYM25RD-G25-085	●	2	
		125	200	14	Modular	R	GYHR2525M90-M25L	●	GYM25LD-G14-125	●	1
				L	GYHL2525M90-M25R	●	GYM25RD-G14-125	●	1		
		25 *2			Modular	R	GYHR2525M90-M25L	●	GYM25LD-G25-125	●	2
					L	GYHL2525M90-M25R	●	GYM25RD-G25-125	●	2	
180	280	14	Modular	R	GYHR2525M90-M25L	●	GYM25LD-G14-180	●	1		
		L	GYHL2525M90-M25R	●	GYM25RD-G14-180	●	1				
25 *2			Modular	R	GYHR2525M90-M25L	●	GYM25LD-G25-180	●	2		
			L	GYHL2525M90-M25R	●	GYM25RD-G25-180	●	2			
250	999	14	Modular	R	GYHR2525M90-M25L	●	GYM25LD-G14-250	●	1		
		L	GYHL2525M90-M25R	●	GYM25RD-G14-250	●	1				
25 *2			Modular	R	GYHR2525M90-M25L	●	GYM25LD-G25-250	●	2		
			L	GYHL2525M90-M25R	●	GYM25RD-G25-250	●	2			

*1 Dimensions shown are when standard insert is used. If other insert geometries are used then LF, LH and WF values may vary.

*2 The maximum groove depth (CDX) varies according to the insert used. Please refer to the maximum groove depth (CDX) of inserts on pages F012—F015.

● : Inventory maintained.

* Wrench : ① : Clamp Screw, ② : Blade Screw

SPARE PARTS			
Holder		 5 pcs.	
	Clamp Screw	Blade Screw	Wrench *
GYHR2525M90-M25L	GY06013M (Clamp Torque : 6.0N·m)	TS55 (Clamp Torque : 5.0N·m)	①TKY30R ②TKY25D
GYHL2525M90-M25R			

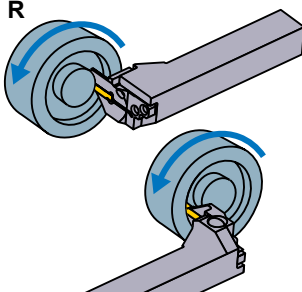
	Dimensions (mm) *1						Cutting Mode
	H	B	LF	LH	HF	WF	
	25	25	150	38	25	53	R 
	25	25	150	38	25	53	
	25	25	150	38	25	53	
	25	25	150	38	25	53	
	25	25	150	38	25	53	
	25	25	150	38	25	64	
	25	25	150	38	25	64	
	25	25	150	38	25	53	
	25	25	150	38	25	53	
	25	25	150	38	25	53	
	25	25	150	38	25	64	
	25	25	150	38	25	64	
	25	25	150	38	25	53	
	25	25	150	38	25	53	
	25	25	150	38	25	53	
	25	25	150	38	25	64	
	25	25	150	38	25	64	
	25	25	150	38	25	53	
	25	25	150	38	25	53	
	25	25	150	38	25	53	
	25	25	150	38	25	64	
	25	25	150	38	25	64	
	25	25	150	38	25	53	
	25	25	150	38	25	53	
	25	25	150	38	25	64	
	25	25	150	38	25	64	
	25	25	150	38	25	53	
	25	25	150	38	25	53	
	25	25	150	38	25	64	
	25	25	150	38	25	64	

Insert selection

Seat Size	Geometry name				
G	GY○○0400/0424G○○○-Breaker shown below				

For grooving/cutting off breaker > F012, F013					
Seat Size	Breaker	GU (For gummy steel)	GS (Low)	GM (Medium)	GFGS (Hardened steel)
G	4.00mm	●	●	●	●

For multifunctional grooving breaker > F014, F015					
Seat Size	Breaker	MF (Finish)	MS (Low)	MM (Medium)	BM (Copying) Ball shape
G	4.00mm				●
	RE 0.2	●	●	●	
	RE 0.4	●	●	●	
	RE 0.8	●		●	
	4.24mm	●			

● : Standard insert with dimensions

GROOVING / CUTTING OFF

IDENTIFICATION > F008, F009
 CUTTING CONDITIONS > F104
 CAUTION FOR USE > F106

GY SERIES (FACE GROOVING)

5

90° type holder

Note 1) For modular blades and modular holders, please order separately.

Note 2) Please use left hand modular blade for right hand holder and right hand modular blade for left hand holder.

Insert	GY2M ^{GS} _{GM}	Insert	GY2G ^{MF}
Insert	GY2M ^{GU}	Insert	GY2M ^{MS}
Insert	GY1 ^{GM} _{GFGS}	Insert	GY2M ^{MM}

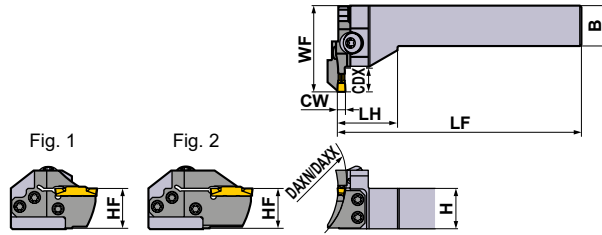
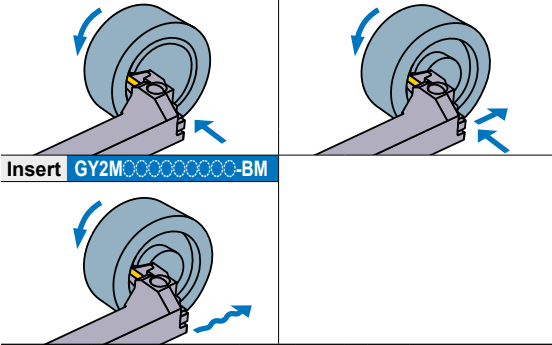

Right hand tool holder shown.



Seat Size	Dimensions (mm)				Type	Hand (R/L)	Order Number				Fig.
	CW	DAXN	DAXX	CDX			Holder	Stock	Modular Blade	Stock	
H	4.75 5.00 5.24	50	60	14	Modular	R	GYHR2525M90-M25L	●	GYM25LD-H14-050	●	1
				L	GYHL2525M90-M25R	●	GYM25RD-H14-050	●	1		
		60	85	14	Modular	R	GYHR2525M90-M25L	●	GYM25LD-H14-060	●	1
				L	GYHL2525M90-M25R	●	GYM25RD-H14-060	●	1		
		25 *2	Modular	R	GYHR2525M90-M25L	●	GYM25LD-H25-060	●	2		
				L	GYHL2525M90-M25R	●	GYM25RD-H25-060	●	2		
		85	125	14	Modular	R	GYHR2525M90-M25L	●	GYM25LD-H14-085	●	1
				L	GYHL2525M90-M25R	●	GYM25RD-H14-085	●	1		
		25 *2	Modular	R	GYHR2525M90-M25L	●	GYM25LD-H25-085	●	2		
				L	GYHL2525M90-M25R	●	GYM25RD-H25-085	●	2		
		125	200	14	Modular	R	GYHR2525M90-M25L	●	GYM25LD-H14-125	●	1
				L	GYHL2525M90-M25R	●	GYM25RD-H14-125	●	1		
		25 *2	Modular	R	GYHR2525M90-M25L	●	GYM25LD-H25-125	●	2		
				L	GYHL2525M90-M25R	●	GYM25RD-H25-125	●	2		
		180	280	14	Modular	R	GYHR2525M90-M25L	●	GYM25LD-H14-180	●	1
				L	GYHL2525M90-M25R	●	GYM25RD-H14-180	●	1		
25 *2	Modular	R	GYHR2525M90-M25L	●	GYM25LD-H25-180	●	2				
		L	GYHL2525M90-M25R	●	GYM25RD-H25-180	●	2				
250	999	14	Modular	R	GYHR2525M90-M25L	●	GYM25LD-H14-250	●	1		
		L	GYHL2525M90-M25R	●	GYM25RD-H14-250	●	1				
25 *2	Modular	R	GYHR2525M90-M25L	●	GYM25LD-H25-250	●	2				
		L	GYHL2525M90-M25R	●	GYM25RD-H25-250	●	2				

*1 Dimensions shown are when standard insert is used. If other insert geometries are used then LF, LH and WF values may vary.

*2 The maximum groove depth (CDX) varies according to the insert used. Please refer to the maximum groove depth (CDX) of inserts on pages F012—F015.

● : Inventory maintained.

* Wrench : ① : Clamp Screw, ② : Blade Screw

SPARE PARTS			
Holder		 5 pcs.	
	Clamp Screw	Blade Screw	Wrench *
GYHR2525M90-M25L	GY06013M (Clamp Torque : 6.0N·m)	TS55 (Clamp Torque : 5.0N·m)	①TKY30R ②TKY25D
GYHL2525M90-M25R			

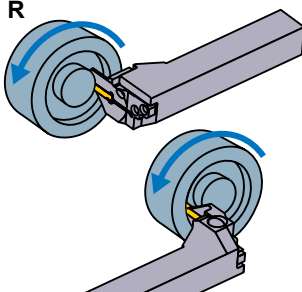
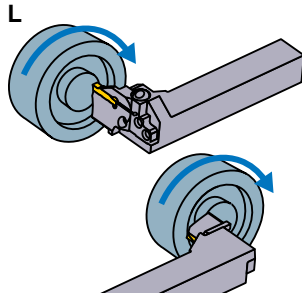
	Dimensions (mm) *1						Cutting Mode
	H	B	LF	LH	HF	WF	
	25	25	150	38	25	53	R 
	25	25	150	38	25	53	
	25	25	150	38	25	53	
	25	25	150	38	25	53	
	25	25	150	38	25	64	
	25	25	150	38	25	64	
	25	25	150	38	25	53	
	25	25	150	38	25	53	
	25	25	150	38	25	64	
	25	25	150	38	25	64	
	25	25	150	38	25	53	L 
	25	25	150	38	25	53	
	25	25	150	38	25	64	
	25	25	150	38	25	64	
	25	25	150	38	25	64	
	25	25	150	38	25	53	
	25	25	150	38	25	53	
	25	25	150	38	25	64	
	25	25	150	38	25	64	
	25	25	150	38	25	53	
	25	25	150	38	25	53	

Insert selection

Seat Size	Geometry name
H	GY○○0475/0500/0524H○○○○○Breaker shown below

For grooving/cutting off breaker > F012, F013					
Seat Size	Breaker	GU	GS	GM	GFGS
		(For gummy steel)	(Low)	(Medium)	(Hardened steel)
H	4.75mm	●	●	●	●
	5.00mm	●	●	●	●

For multifunctional grooving breaker > F014, F015					
Seat Size	Breaker	MF	MS	MM	BM
		(Finish)	(Low)	(Medium)	(Copying)
H	4.75mm				●
	RE 0.2	●			
	RE 0.4	●			
	RE 0.8	●			
	5.00mm				●
	RE 0.2	●			
	RE 0.4	●	●	●	
	RE 0.8	●	●	●	
	5.24mm	●			

● : Standard insert with dimensions

GROOVING / CUTTING OFF

IDENTIFICATION > F008, F009
 CUTTING CONDITIONS > F104
 CAUTION FOR USE > F106

GY SERIES (FACE GROOVING)

5

90° type holder

Note 1) For modular blades and modular holders, please order separately.

Note 2) Please use left hand modular blade for right hand holder and right hand modular blade for left hand holder.

Insert	GY2M ^{GS} _{GM}	Insert	GY2G ^{MF}
Insert	GY2M ^{GU}	Insert	GY2M ^{MS}
Insert	GY1 ^{GM} _{GFGS}	Insert	GY2M ^{MM}

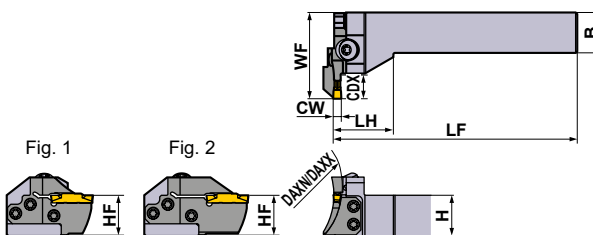
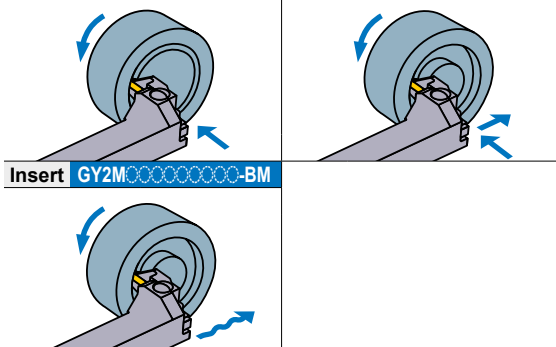

Right hand tool holder shown.



Seat Size	Dimensions (mm)				Type	Hand (R/L)	Order Number				Fig.
	CW	DAXN	DAXX	CDX			Holder	Stock	Modular Blade	Stock	
J	6.00 6.31 6.35	50	70	14	Modular	R	GYHR2525M90-M25L	●	GYM25LD-J14-050	●	1
				L	GYHL2525M90-M25R	●	GYM25RD-J14-050	●	1		
		70	110	14	Modular	R	GYHR2525M90-M25L	●	GYM25LD-J14-070	●	1
				L	GYHL2525M90-M25R	●	GYM25RD-J14-070	●	1		
		110	200	25 *2	Modular	R	GYHR2525M90-M25L	●	GYM25LD-J25-070	●	2
				L	GYHL2525M90-M25R	●	GYM25RD-J25-070	●	2		
	170	280	14	Modular	R	GYHR2525M90-M25L	●	GYM25LD-J14-110	●	1	
			L	GYHL2525M90-M25R	●	GYM25RD-J14-110	●	1			
	250	999	25 *2	Modular	R	GYHR2525M90-M25L	●	GYM25LD-J25-110	●	2	
			L	GYHL2525M90-M25R	●	GYM25RD-J25-110	●	2			
	250	999	14	Modular	R	GYHR2525M90-M25L	●	GYM25LD-J14-170	●	1	
			L	GYHL2525M90-M25R	●	GYM25RD-J14-170	●	1			
250	999	25 *2	Modular	R	GYHR2525M90-M25L	●	GYM25LD-J25-170	●	2		
		L	GYHL2525M90-M25R	●	GYM25RD-J25-170	●	2				
250	999	14	Modular	R	GYHR2525M90-M25L	●	GYM25LD-J14-250	●	1		
		L	GYHL2525M90-M25R	●	GYM25RD-J14-250	●	1				
250	999	25 *2	Modular	R	GYHR2525M90-M25L	●	GYM25LD-J25-250	●	2		
		L	GYHL2525M90-M25R	●	GYM25RD-J25-250	●	2				

*1 Dimensions shown are when standard insert is used. If other insert geometries are used then LF, LH and WF values may vary.

*2 The maximum groove depth (CDX) varies according to the insert used. Please refer to the maximum groove depth (CDX) of inserts on pages F012—F015.

● : Inventory maintained.

* Wrench : ① : Clamp Screw, ② : Blade Screw

SPARE PARTS			
Holder		 5 pcs.	
	Clamp Screw	Blade Screw	Wrench *
GYHR2525M90-M25L	GY06013M (Clamp Torque : 6.0N·m)	TS55 (Clamp Torque : 5.0N·m)	①TKY30R ②TKY25D
GYHL2525M90-M25R			

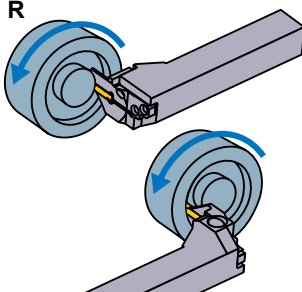
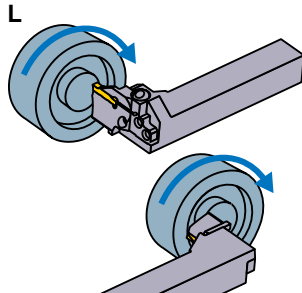
	Dimensions (mm) *1						Cutting Mode
	H	B	LF	LH	HF	WF	
	25	25	150	38	25	53	
	25	25	150	38	25	53	
	25	25	150	38	25	53	
	25	25	150	38	25	53	
	25	25	150	38	25	64	
	25	25	150	38	25	64	
	25	25	150	38	25	53	
	25	25	150	38	25	53	
	25	25	150	38	25	64	
	25	25	150	38	25	64	
	25	25	150	38	25	53	
	25	25	150	38	25	53	
	25	25	150	38	25	64	
	25	25	150	38	25	64	
	25	25	150	38	25	53	
	25	25	150	38	25	53	
	25	25	150	38	25	64	
	25	25	150	38	25	64	

Insert selection

Seat Size	Geometry name
J	GY○○0600/0631/0635J○○○○-Breaker shown below

For grooving/cutting off breaker > F012, F013					
Seat Size	Breaker	GU	GS	GM	GFGS
		(For gummy steel)	(Low)	(Medium)	(Hardened steel)
J	6.00mm	●	●	●	●
	6.35mm	●	●	●	●

For multifunctional grooving breaker > F014, F015					
Seat Size	Breaker	MF	MS	MM	BM
		(Finish)	(Low)	(Medium)	(Copying)
J	6.00mm				●
	RE 0.2	●			
	RE 0.4	●	●	●	
	RE 0.8	●	●	●	
	6.31mm	●			
	6.35mm				●
	RE 0.2	●			
	RE 0.4	●			

● : Standard insert with dimensions

GROOVING / CUTTING OFF

IDENTIFICATION > F008, F009
 CUTTING CONDITIONS > F104
 CAUTION FOR USE > F106

GY SERIES (INTERNAL GROOVING)

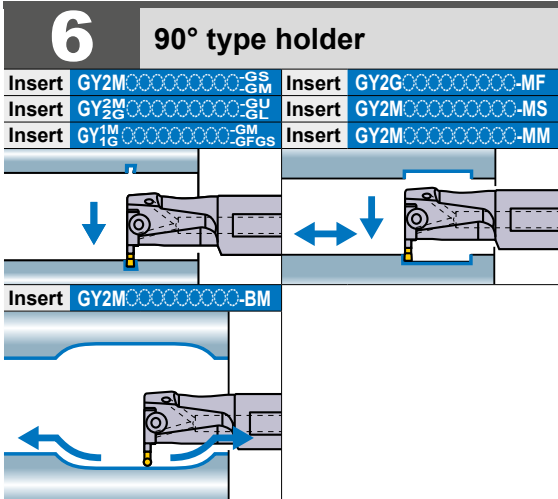

Note 1) For modular blades and modular holders, please order separately.
 Note 2) Please use left hand modular blade for right hand holder and right hand modular blade for left hand holder.

● Monoblock type (Air / coolant through)

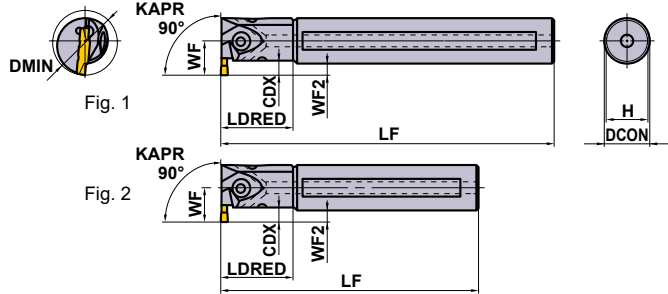

Right hand tool holder shown.

Seat Size	Dimensions (mm)			Type	Hand (R/L)	Order Number				Fig.	
	CW	CDX *3	DMIN			Holder	Stock	Modular Blade	Stock		
D	2.00 2.24	6	25	Monoblock	R	GYAR20K90A-D06	●	—	—	2	
				Monoblock	L	GYAL20K90A-D06	●	—	—	2	
			Monoblock	R	GYAR20Q90A-D06	●	—	—	1		
			Monoblock	L	GYAL20Q90A-D06	●	—	—	1		
		32	Monoblock	R	GYAR25K90B-D06	●	—	—	—	2	
			Monoblock	L	GYAL25K90B-D06	●	—	—	—	2	
		40	4—9.5 *1	Modular	R	GYDR32L90C-M20L	●	GYM20LA-D10	●	4	
				Modular	L	GYDL32L90C-M20R	●	GYM20RA-D10	●	4	
		50	5.5—9.5 *1	Modular	R	GYDR32S90C-M20L	●	GYM20LA-D10	●	3	
				Modular	L	GYDL32S90C-M20R	●	GYM20RA-D10	●	3	
		60	7—11.5 *1	60	Modular	R	GYDR40M90D-M20L	●	GYM20LA-D10	●	4
					Modular	L	GYDL40M90D-M20R	●	GYM20RA-D10	●	4
	70	7—11.5 *1	70	Modular	R	GYDR40T90D-M20L	●	GYM20LA-D10	●	3	
				Modular	L	GYDL40T90D-M20R	●	GYM20RA-D10	●	3	
	70	7—11.5 *1	70	Modular	R	GYDR40M90D-M25L	●	GYM25LA-D12	●	4	
				Modular	L	GYDL40M90D-M25R	●	GYM25RA-D12	●	4	
	70	7—11.5 *1	70	Modular	R	GYDR40T90D-M25L	●	GYM25LA-D12	●	3	
				Modular	L	GYDL40T90D-M25R	●	GYM25RA-D12	●	3	
	70	7—11.5 *1	70	Modular	R	GYDR50P90F-M25L	●	GYM25LA-D12	●	4	
				Modular	L	GYDL50P90F-M25R	●	GYM25RA-D12	●	4	
70	7—11.5 *1	70	Modular	R	GYDR50T90F-M25L	●	GYM25LA-D12	●	3		
			Modular	L	GYDL50T90F-M25R	●	GYM25RA-D12	●	3		

*1 The maximum groove depth (CDX) varies according to the cutting diameter (DMIN). For details, please refer to page F111.
 *2 Dimensions shown are when the standard insert is used. If other insert geometries are used then LF, LDRED, WF and WF2 values may vary.
 *3 The maximum groove depth (CDX) is a value within the dimension LDRED.

● : Inventory maintained.

GROOVING / CUTTING OFF

●Modular blade type (Air / coolant through)

* Wrench : ① : Clamp Screw, ② : Blade Screw

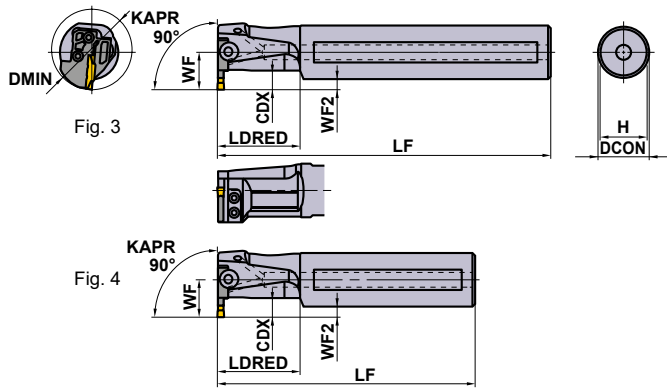

Right hand tool holder shown.

SPARE PARTS

Holder	① Clamp Screw	② Blade Screw 4 pcs.	① Wrench *
GYAR/L20○90A-○06	①GY05016S (Clamp Torque : 5.0N·m)	—	①TKY20R
GYAR/L25○90B-○06	①GY05016S (Clamp Torque : 5.0N·m)	—	①TKY20R
GYDR/L32○90C-M20L/R	②GY06013M (Clamp Torque : 6.0N·m)	TS407 (Clamp Torque : 3.5N·m)	①TKY30R ②TKY15D
GYDR/L40○90D-M20L/R	②GY06013M (Clamp Torque : 6.0N·m)	TS407 (Clamp Torque : 3.5N·m)	①TKY30R ②TKY15D
GYDR/L40○90D-M25L/R	②GY06013M (Clamp Torque : 6.0N·m)	TS55 (Clamp Torque : 5.0N·m)	①TKY30R ②TKY25D
GYDR/L50○90F-M25L/R	②GY06013M (Clamp Torque : 6.0N·m)	TS55 (Clamp Torque : 5.0N·m)	①TKY30R ②TKY25D

	Dimensions (mm) *2						Cutting Mode
	DCON	LF	LDRED	WF	WF2	H	
	20	125	30	14.5	4.5	18	R
	20	125	30	14.5	4.5	18	
	20	180	30	14.5	4.5	18	
	20	180	30	14.5	4.5	18	
	25	125	40	19	6.5	23	L
	25	125	40	19	6.5	23	
	25	200	40	19	6.5	23	
	25	200	40	19	6.5	23	
	32	140	50	22	6	30	L
	32	140	50	22	6	30	
	32	250	50	22	6	30	
	32	250	50	22	6	30	
	40	150	60	28	8	37	L
	40	150	60	28	8	37	
	40	300	60	28	8	37	
	40	300	60	28	8	37	
	40	150	60	28	8	37	L
	40	150	60	28	8	37	
	40	300	60	28	8	37	
	40	300	60	28	8	37	
	50	170	80	34	9	47	L
	50	170	80	34	9	47	
	50	300	80	34	9	47	
	50	300	80	34	9	47	

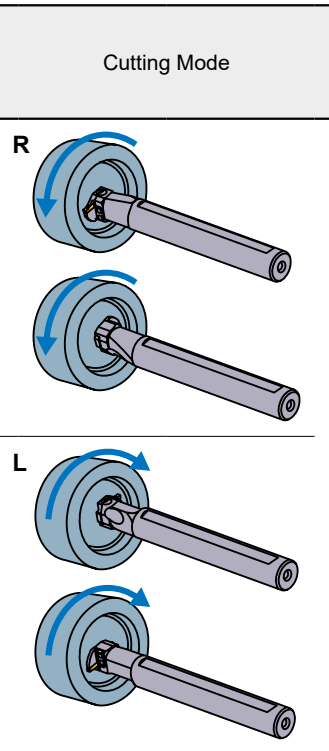

Insert selection

Seat Size	Geometry name
D	GY○○0200/0224D○○○○○-Breaker shown below

For grooving/cutting off breaker > F012, F013						
Seat Size	Breaker	GU (For gummy steel)	GS (Low)	GM (Medium)	GL (Aluminium alloy)	GFGS (Hardened steel)
D	2.00mm	●	●	●	●	●

For multifunctional grooving breaker > F014, F015					
Seat Size	Breaker	MF (Finish)	MS (Low)	MM (Medium)	BM (Copying)
D	2.00mm	●	●	●	●
	2.24mm	●	●	●	●

● : Standard insert with dimensions

IDENTIFICATION > F008, F009
 CUTTING CONDITIONS > F110
 CAUTION FOR USE > F112

GY SERIES (INTERNAL GROOVING)

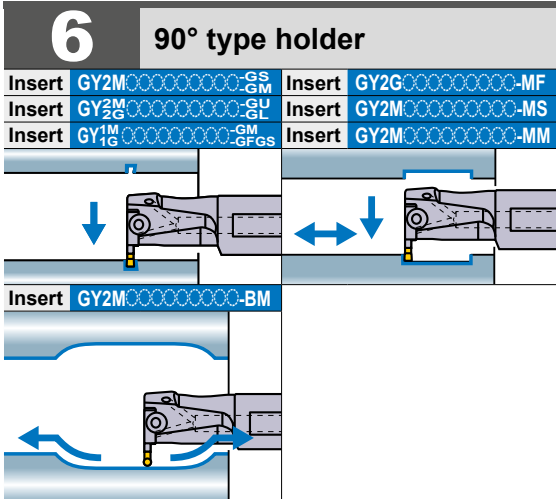

Note 1) For modular blades and modular holders, please order separately.
 Note 2) Please use left hand modular blade for right hand holder and right hand modular blade for left hand holder.

● Monoblock type (Air / coolant through)

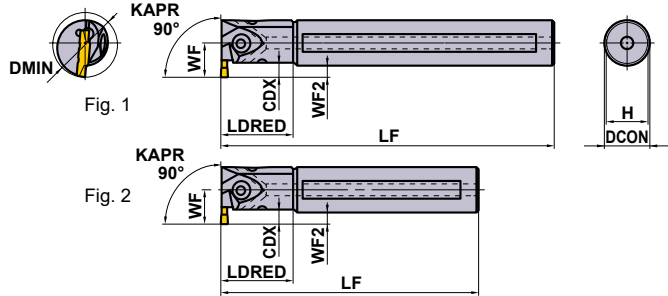

Right hand tool holder shown.

Seat Size	Dimensions (mm)			Type	Hand (R/L)	Order Number				Fig.	
	CW	CDX *3	DMIN			Holder	Stock	Modular Blade	Stock		
E	2.39	6	25	Monoblock	R	GYAR20K90A-E06	●	—	—	2	
				Monoblock	L	GYAL20K90A-E06	●	—	—	2	
			Monoblock	R	GYAR20Q90A-E06	●	—	—	1		
			Monoblock	L	GYAL20Q90A-E06	●	—	—	1		
		32	Monoblock	R	GYAR25K90B-E06	●	—	—	—	2	
			Monoblock	L	GYAL25K90B-E06	●	—	—	—	2	
		4—9.5 *1	40	Modular	R	GYDR32L90C-M20L	●	GYM20LA-E10	●	●	4
				Modular	L	GYDL32L90C-M20R	●	GYM20RA-E10	●	●	4
	Modular		R	GYDR32S90C-M20L	●	GYM20LA-E10	●	●	3		
			L	GYDL32S90C-M20R	●	GYM20RA-E10	●	●	3		
	5.5—9.5 *1	50	Modular	R	GYDR40M90D-M20L	●	GYM20LA-E10	●	●	4	
			Modular	L	GYDL40M90D-M20R	●	GYM20RA-E10	●	●	4	
		Modular	R	GYDR40T90D-M20L	●	GYM20LA-E10	●	●	3		
			L	GYDL40T90D-M20R	●	GYM20RA-E10	●	●	3		
	7—11.5 *1	60	Modular	R	GYDR40M90D-M25L	●	GYM25LA-E12	●	●	4	
			Modular	L	GYDL40M90D-M25R	●	GYM25RA-E12	●	●	4	
		Modular	R	GYDR40T90D-M25L	●	GYM25LA-E12	●	●	3		
			L	GYDL40T90D-M25R	●	GYM25RA-E12	●	●	3		
		70	Modular	R	GYDR50P90F-M25L	●	GYM25LA-E12	●	●	4	
			Modular	L	GYDL50P90F-M25R	●	GYM25RA-E12	●	●	4	
Modular	R	GYDR50T90F-M25L	●	GYM25LA-E12	●	●	●	3			
	L	GYDL50T90F-M25R	●	GYM25RA-E12	●	●	●	3			

*1 The maximum groove depth (CDX) varies according to the cutting diameter (DMIN). For details, please refer to page F111.
 *2 Dimensions shown are when the standard insert is used. If other insert geometries are used then LF, LDRED, WF and WF2 values may vary.
 *3 The maximum groove depth (CDX) is a value within the dimension LDRED.

● : Inventory maintained.

GROOVING / CUTTING OFF

●Modular blade type (Air / coolant through)

* Wrench : ① : Clamp Screw, ② : Blade Screw

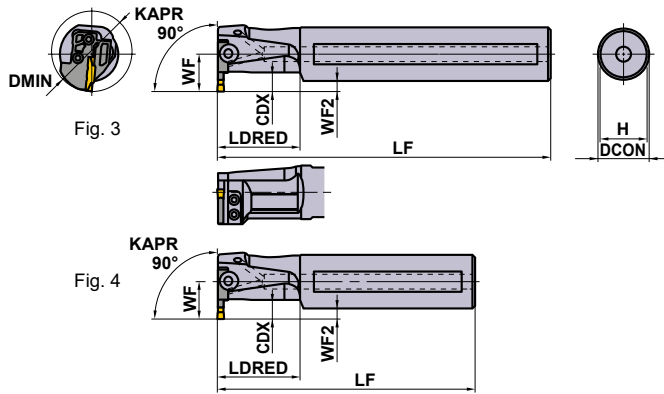

SPARE PARTS

Holder	① Clamp Screw	② Blade Screw 4 pcs.	① Wrench *
GYAR/L20○90A-○06	①GY05016S (Clamp Torque : 5.0N·m)	—	①TKY20R
GYAR/L25○90B-○06	①GY05016S (Clamp Torque : 5.0N·m)	—	①TKY20R
GYDR/L32○90C-M20L/R	②GY06013M (Clamp Torque : 6.0N·m)	TS407 (Clamp Torque : 3.5N·m)	①TKY30R ②TKY15D
GYDR/L40○90D-M20L/R	②GY06013M (Clamp Torque : 6.0N·m)	TS407 (Clamp Torque : 3.5N·m)	①TKY30R ②TKY15D
GYDR/L40○90D-M25L/R	②GY06013M (Clamp Torque : 6.0N·m)	TS55 (Clamp Torque : 5.0N·m)	①TKY30R ②TKY25D
GYDR/L50○90F-M25L/R	②GY06013M (Clamp Torque : 6.0N·m)	TS55 (Clamp Torque : 5.0N·m)	①TKY30R ②TKY25D

Right hand tool holder shown.

	Dimensions (mm) *2						Cutting Mode
	DCON	LF	LDRED	WF	WF2	H	
	20	125	30	14.5	4.5	18	R
	20	125	30	14.5	4.5	18	
	20	180	30	14.5	4.5	18	
	20	180	30	14.5	4.5	18	
	25	125	40	19	6.5	23	L
	25	125	40	19	6.5	23	
	25	200	40	19	6.5	23	
	25	200	40	19	6.5	23	
	32	140	50	22	6	30	L
	32	140	50	22	6	30	
	32	250	50	22	6	30	
	32	250	50	22	6	30	
	40	150	60	28	8	37	
	40	150	60	28	8	37	
	40	300	60	28	8	37	
	40	300	60	28	8	37	
	40	150	60	28	8	37	
	40	150	60	28	8	37	
	40	300	60	28	8	37	
	40	300	60	28	8	37	
	50	170	80	34	9	47	
	50	170	80	34	9	47	
	50	300	80	34	9	47	
	50	300	80	34	9	47	

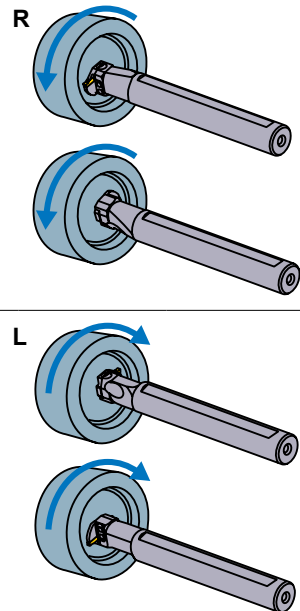

Insert selection

Seat Size	Geometry name
E	GY○○0239/0250/0274E○○○○○-Breaker shown below

For grooving/cutting off breaker > F012, F013						
Seat Size	Breaker	GU (For gummy steel)	GS (Low)	GM (Medium)	GL (Aluminium alloy)	GFGS (Hardened steel)
E	CW					
		2.39mm	●	●	●	●
		2.50mm	●	●	●	●

For multifunctional grooving breaker > F014, F015					
Seat Size	Breaker	MF (Finish)	MS (Low)	MM (Medium)	BM (Copying) Ball nose
E	CW				
		2.39mm	●		
		2.50mm	●	●	
		2.74mm	●		

● : Standard insert with dimensions

IDENTIFICATION > F008, F009
CUTTING CONDITIONS > F110
CAUTION FOR USE > F112

GY SERIES (INTERNAL GROOVING)

6

90° type holder

Note 1) For modular blades and modular holders, please order separately.
 Note 2) Please use left hand modular blade for right hand holder and right hand modular blade for left hand holder.

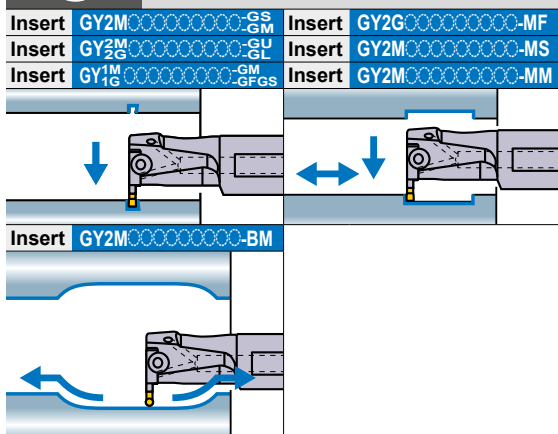

● Monoblock type (Air / coolant through)

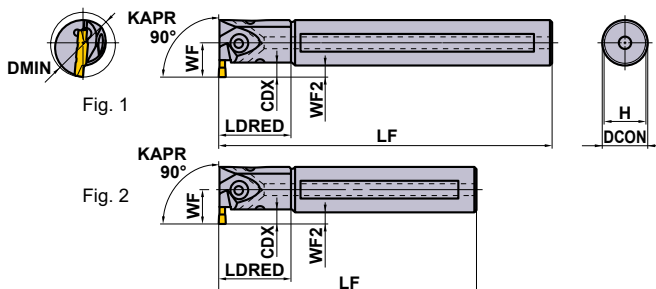

Right hand tool holder shown.

GROOVING / CUTTING OFF

F

Seat Size	Dimensions (mm)			Type	Hand (R/L)	Order Number				Fig.
	CW	CDX *3	DMIN			Holder	Stock	Modular Blade	Stock	
F	3.00 3.18 3.24	6	25	Monoblock	R	GYAR20K90A-F06	●	—	—	2
				L	GYAL20K90A-F06	●	—	—	2	
			Monoblock	R	GYAR20Q90A-F06	●	—	—	1	
			L	GYAL20Q90A-F06	●	—	—	1		
		32	Monoblock	R	GYAR25K90B-F06	●	—	—	2	
			L	GYAL25K90B-F06	●	—	—	2		
		40	Modular	R	GYDR32L90C-M20L	●	GYM20LA-F10	●	4	
			L	GYDL32L90C-M20R	●	GYM20RA-F10	●	4		
	50	Modular	R	GYDR32S90C-M20L	●	GYM20LA-F10	●	3		
		L	GYDL32S90C-M20R	●	GYM20RA-F10	●	3			
	7—11.5 *1	60	Modular	R	GYDR40M90D-M20L	●	GYM20LA-F10	●	4	
			L	GYDL40M90D-M20R	●	GYM20RA-F10	●	4		
		70	Modular	R	GYDR40T90D-M20L	●	GYM20LA-F10	●	3	
			L	GYDL40T90D-M20R	●	GYM20RA-F10	●	3		
		70	Modular	R	GYDR40M90D-M25L	●	GYM25LA-F12	●	4	
			L	GYDL40M90D-M25R	●	GYM25RA-F12	●	4		
G	4.00 4.24	7	Monoblock	R	GYAR25K90B-G07	●	—	—	2	
			L	GYAL25K90B-G07	●	—	—	2		
		32	Monoblock	R	GYAR25R90B-G07	●	—	—	1	
			L	GYAL25R90B-G07	●	—	—	1		
		40	Modular	R	GYDR32L90C-M20L	●	GYM20LA-G12	●	4	
			L	GYDL32L90C-M20R	●	GYM20RA-G12	●	4		
	50	Modular	R	GYDR32S90C-M20L	●	GYM20LA-G12	●	3		
		L	GYDL32S90C-M20R	●	GYM20RA-G12	●	3			
	7.5—13 *1	60	Modular	R	GYDR40M90D-M20L	●	GYM20LA-G12	●	4	
			L	GYDL40M90D-M20R	●	GYM20RA-G12	●	4		
		70	Modular	R	GYDR40T90D-M20L	●	GYM20LA-G12	●	3	
			L	GYDL40T90D-M20R	●	GYM20RA-G12	●	3		
70		Modular	R	GYDR40M90D-M25L	●	GYM25LA-G14	●	4		
		L	GYDL40M90D-M25R	●	GYM25RA-G14	●	4			

*1 The maximum groove depth (CDX) varies according to the cutting diameter (DMIN). For details, please refer to page F111.
 *2 Dimensions shown are when the standard insert is used. If other insert geometries are used then LF, LDRED, WF and WF2 values may vary.
 *3 The maximum groove depth (CDX) is a value within the dimension LDRED.

● : Inventory maintained.

●Modular blade type (Air / coolant through)

* Wrench : ① : Clamp Screw, ② : Blade Screw

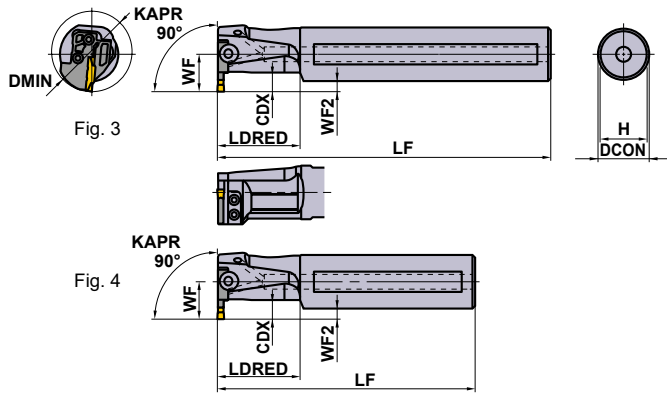

SPARE PARTS

Holder	① Clamp Screw	② Blade Screw 4 pcs.	① Wrench *
GYAR/L20 ○90A-F06	①GY05016S (Clamp Torque : 5.0N·m)	—	①TKY20R
GYAR/L25 ○90B-○○○	—	—	—
GYDR/L32 ○90C-M20L/R	②GY06013M (Clamp Torque : 6.0N·m)	TS407 (Clamp Torque : 3.5N·m)	①TKY30R ②TKY15D
GYDR/L40 ○90D-M20L/R	②GY06013M (Clamp Torque : 6.0N·m)	TS55 (Clamp Torque : 5.0N·m)	①TKY30R ②TKY25D
GYDR/L40 ○90D-M25L/R	②GY06013M (Clamp Torque : 6.0N·m)	TS55 (Clamp Torque : 5.0N·m)	①TKY30R ②TKY25D
GYDR/L50 ○90F-M25L/R	②GY06013M (Clamp Torque : 6.0N·m)	TS55 (Clamp Torque : 5.0N·m)	①TKY30R ②TKY25D

Right hand tool holder shown.

	Dimensions (mm) *2						Cutting Mode
	DCON	LF	LDRED	WF	WF2	H	
	20	125	30	14.5	4.5	18	R
	20	125	30	14.5	4.5	18	
	20	180	30	14.5	4.5	18	
	20	180	30	14.5	4.5	18	
	25	125	40	19	6.5	23	
	25	125	40	19	6.5	23	
	25	200	40	19	6.5	23	
	25	200	40	19	6.5	23	
	32	140	50	22	6	30	
	32	140	50	22	6	30	
	32	250	50	22	6	30	
	32	250	50	22	6	30	
	40	150	60	28	8	37	
	40	150	60	28	8	37	
	40	300	60	28	8	37	
	40	300	60	28	8	37	
	40	150	60	28	8	37	
	40	150	60	28	8	37	
	40	300	60	28	8	37	
	40	300	60	28	8	37	
	50	170	80	34	9	47	
	50	170	80	34	9	47	
	50	300	80	34	9	47	
	50	300	80	34	9	47	
	25	125	40	19	6.5	23	L
	25	125	40	19	6.5	23	
	25	200	40	19	6.5	23	
	25	200	40	19	6.5	23	
	32	140	50	22	6	30	
	32	140	50	22	6	30	
	32	250	50	22	6	30	
	32	250	50	22	6	30	
	40	150	60	28	8	37	
	40	150	60	28	8	37	
	40	300	60	28	8	37	
	40	300	60	28	8	37	
	40	150	60	28	8	37	
	40	150	60	28	8	37	
	40	300	60	28	8	37	
	40	300	60	28	8	37	
	50	170	80	34	9	47	
	50	170	80	34	9	47	
	50	300	80	34	9	47	
	50	300	80	34	9	47	

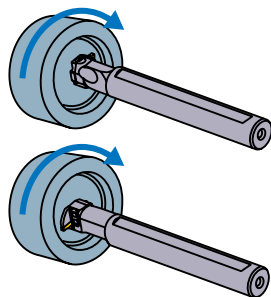
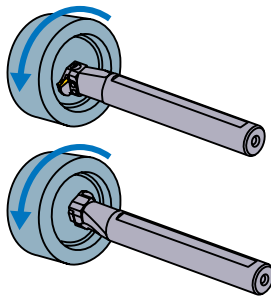

Insert selection

Seat Size	Geometry name
F	GY○○0300/0318/0324F○○○○○-Breaker shown below

For grooving/cutting off breaker > F012, F013						
Seat Size	Breaker	GU (For gummy steel)	GS (Low)	GM (Medium)	GL (Aluminium alloy)	GFGS (Hardened steel)
F	CW					
		3.00mm	●	●	●	●
		3.18mm	●	●	●	●

For multifunctional grooving breaker > F014, F015						
Seat Size	Breaker	MF (Finish)	MS (Low)	MM (Medium)	BM (Copying)	
F	CW				Ball nose	
			3.00mm			●
		RE 0.2	●	●	●	
		RE 0.4	●	●	●	
		RE 0.8			●	
		3.18mm				●
		RE 0.2	●			
		RE 0.4	●			
		3.24mm	●			

Seat Size	Geometry name
G	GY○○0400/0424G○○○○○-Breaker shown below

For grooving/cutting off breaker > F012, F013					
Seat Size	Breaker	GU (For gummy steel)	GS (Low)	GM (Medium)	GFGS (Hardened steel)
G	CW				
		4.00mm	●	●	●

For multifunctional grooving breaker > F014, F015						
Seat Size	Breaker	MF (Finish)	MS (Low)	MM (Medium)	BM (Copying)	
G	CW				Ball nose	
			4.00mm			●
		RE 0.2	●	●	●	
		RE 0.4	●	●	●	
		RE 0.8	●		●	
		4.24mm	●			

● : Standard insert with dimensions

IDENTIFICATION > F008, F009
CUTTING CONDITIONS > F110
CAUTION FOR USE > F112

GY SERIES (INTERNAL GROOVING)

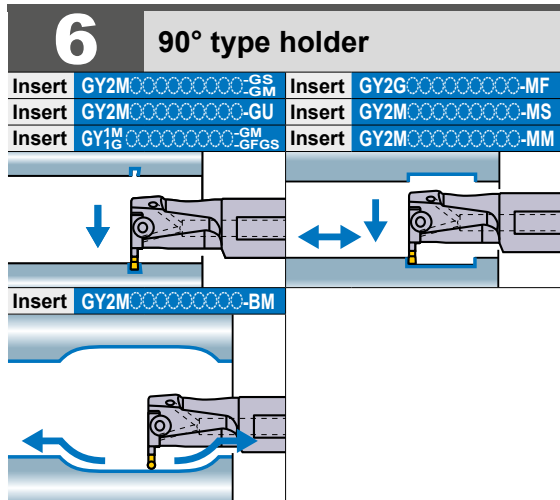

Note 1) For modular blades and modular holders, please order separately.
 Note 2) Please use left hand modular blade for right hand holder and right hand modular blade for left hand holder.

● Monoblock type (Air / coolant through)

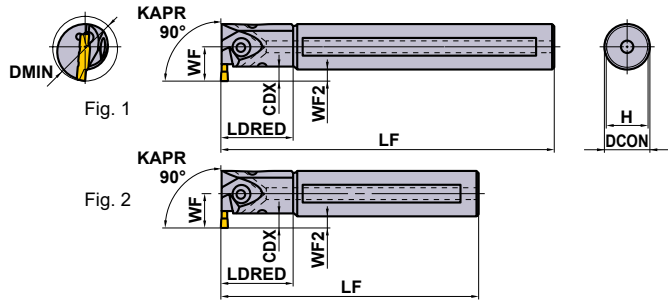

Right hand tool holder shown.

Seat Size	Dimensions (mm)			Type	Hand (R/L)	Order Number				Fig.
	CW	CDX *3	DMIN			Holder	Stock	Modular Blade	Stock	
H	4.75 5.00 5.24	7	32	Monoblock	R	GYAR25K90B-H07	●	—	—	2
				Monoblock	L	GYAL25K90B-H07	●	—	—	2
		4.5—11.5 *1	40	Modular	R	GYDR32L90C-M20L	●	GYM20LA-H12	●	4
				Modular	L	GYDL32L90C-M20R	●	GYM20RA-H12	●	4
		6—11.5 *1	50	Modular	R	GYDR32S90C-M20L	●	GYM20LA-H12	●	3
				Modular	L	GYDL32S90C-M20R	●	GYM20RA-H12	●	3
	7.5—13 *1	60	Modular	R	GYDR40M90D-M20L	●	GYM20LA-H12	●	4	
			Modular	L	GYDL40M90D-M20R	●	GYM20RA-H12	●	4	
		70	Modular	R	GYDR40T90D-M20L	●	GYM20LA-H12	●	3	
			Modular	L	GYDL40T90D-M20R	●	GYM20RA-H12	●	3	
		7.5—13 *1	60	Modular	R	GYDR40M90D-M25L	●	GYM25LA-H14	●	4
				Modular	L	GYDL40M90D-M25R	●	GYM25RA-H14	●	4
J	6.00 6.31 6.35	7.5—13 *1	60	Modular	R	GYDR40M90D-M25L	●	GYM25LA-J14	●	4
				Modular	L	GYDL40M90D-M25R	●	GYM25RA-J14	●	4
		70	Modular	R	GYDR40T90D-M25L	●	GYM25LA-J14	●	3	
			Modular	L	GYDL40T90D-M25R	●	GYM25RA-J14	●	3	
		7.5—13 *1	70	Modular	R	GYDR50P90F-M25L	●	GYM25LA-J14	●	4
				Modular	L	GYDL50P90F-M25R	●	GYM25RA-J14	●	4
	7.5—13 *1	70	Modular	R	GYDR50T90F-M25L	●	GYM25LA-J14	●	3	
			Modular	L	GYDL50T90F-M25R	●	GYM25RA-J14	●	3	

*1 The maximum groove depth (CDX) varies according to the cutting diameter (DMIN). For details, please refer to page F111.
 *2 Dimensions shown are when the standard insert is used. If other insert geometries are used then LF, LDRED, WF and WF2 values may vary.
 *3 The maximum groove depth (CDX) is a value within the dimension LDRED.

● : Inventory maintained.

●Modular blade type (Air / coolant through)

* Wrench : ① : Clamp Screw, ② : Blade Screw

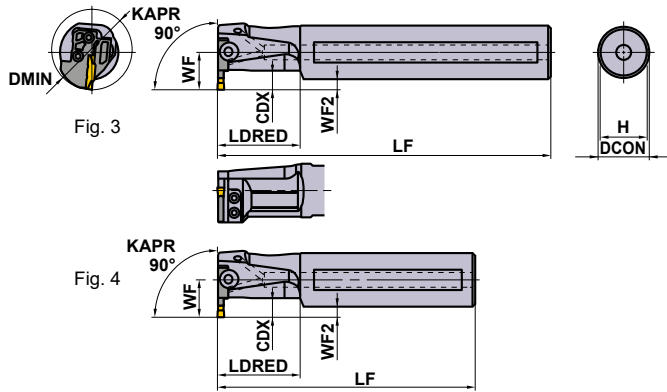

SPARE PARTS

Holder	① Clamp Screw	② Blade Screw 4 pcs.	① Wrench *
GYAR/L25○90B-○07	①GY05016S (Clamp Torque : 5.0N·m)	—	①TKY20R
GYDR/L32○90C-M20L/R	②GY06013M (Clamp Torque : 6.0N·m)	TS407 (Clamp Torque : 3.5N·m)	①TKY30R ②TKY15D
GYDR/L40○90D-M20L/R	②GY06013M (Clamp Torque : 6.0N·m)	TS55 (Clamp Torque : 5.0N·m)	①TKY30R ②TKY25D
GYDR/L50○90F-M25L/R	②GY06013M (Clamp Torque : 6.0N·m)	TS55 (Clamp Torque : 5.0N·m)	①TKY30R ②TKY25D

Right hand tool holder shown.

	Dimensions (mm) *2						Cutting Mode
	DCON	LF	LDRED	WF	WF2	H	
	25	125	40	19	6.5	23	R
	25	125	40	19	6.5	23	
	25	200	40	19	6.5	23	
	25	200	40	19	6.5	23	
	32	140	50	22	6	30	R
	32	140	50	22	6	30	
	32	250	50	22	6	30	
	32	250	50	22	6	30	
	40	150	60	28	8	37	
	40	150	60	28	8	37	
	40	300	60	28	8	37	
	40	300	60	28	8	37	
	40	150	60	28	8	37	
	40	150	60	28	8	37	
	40	300	60	28	8	37	
	40	300	60	28	8	37	
	50	170	80	34	9	47	L
	50	170	80	34	9	47	
	50	300	80	34	9	47	
	50	300	80	34	9	47	
	40	150	60	28	8	37	
	40	150	60	28	8	37	
	40	300	60	28	8	37	
	40	300	60	28	8	37	
	50	170	80	34	9	47	
	50	170	80	34	9	47	
	50	300	80	34	9	47	
	50	300	80	34	9	47	

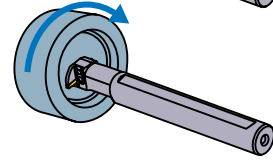
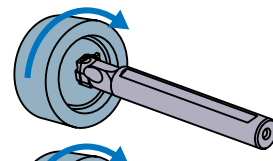
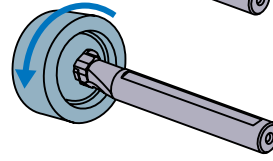
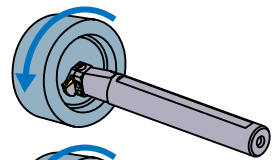

Insert selection

Seat Size	Geometry name
H	GY○○○0475/0500/0524H○○○○○-Breaker shown below

For grooving/cutting off breaker > F012, F013					
Seat Size	Breaker CW	GU	GS	GM	GFGS
		(For gummy steel)	(Low)	(Medium)	(Hardened steel)
H	4.75mm	●	●	●	●
	5.00mm	●	●	●	●

For multifunctional grooving breaker > F014, F015					
Seat Size	Breaker CW	MF	MS	MM	BM
		(Finish)	(Low)	(Medium)	(Copying)
H	4.75mm				●
	RE 0.2	●			
	RE 0.4	●			
	RE 0.8	●			
	5.00mm				●
	RE 0.2	●			
	RE 0.4	●	●	●	
	RE 0.8	●	●	●	
5.24mm	●				

Seat Size	Geometry name
J	GY○○○0600/0631/0635J○○○○○-Breaker shown below

For grooving/cutting off breaker > F012, F013					
Seat Size	Breaker CW	GU	GS	GM	GFGS
		(For gummy steel)	(Low)	(Medium)	(Hardened steel)
J	6.00mm	●	●	●	
	6.35mm	●	●	●	

For multifunctional grooving breaker > F014, F015					
Seat Size	Breaker CW	MF	MS	MM	BM
		(Finish)	(Low)	(Medium)	(Copying)
J	6.00mm				●
	RE 0.2	●			
	RE 0.4	●	●	●	
	RE 0.8	●	●	●	
	6.31mm	●			
	6.35mm				●
	RE 0.2	●			
	RE 0.4	●			
RE 0.8	●				

● : Standard insert with dimensions

IDENTIFICATION > F008, F009
 CUTTING CONDITIONS > F110
 CAUTION FOR USE > F112

GY SERIES (EXTERNAL / FACE GROOVING)

PSC 00° type holder

NEW

Note 1) Please order the modular blade and modular holder separately.

Note 2) Please set the right hand modular blade at the right hand holder and the left hand modular blade at the left hand holder.

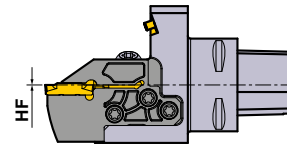
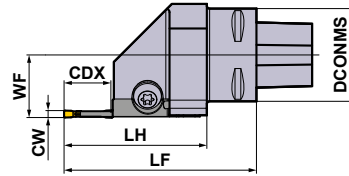

Right hand tool holder shown.

(mm)

Order Number	Stock	Hand (R/L)	Coolant	Mounting Size	DCONMS	CW
C4-GYHERM00-M25R	★	R	External	PSC40	40	2.0–6.35
C4-GYHELM00-M25L	★	L	External	PSC40	40	2.0–6.35
C5-GYHERM00-M25R	★	R	External	PSC50	50	2.0–6.35
C5-GYHELM00-M25L	★	L	External	PSC50	50	2.0–6.35
C6-GYHERM00-M25R	★	R	External	PSC60	60	2.0–6.35
C6-GYHELM00-M25L	★	L	External	PSC60	60	2.0–6.35

GROOVING / CUTTING OFF

Set Dimensions with Modular Blades

Holder Type	Modular Blade Type	Standard CW	CDX	WF	HF	LF	LH
C4-GYHER/LM00-M25R/L	GYM25R/L○-D06	2.0	6	27.0	0	69	47.6
C4-GYHER/LM00-M25R/L	GYM25R/L○-D12	2.0	12	27.0	0	77	55.6
C4-GYHER/LM00-M25R/L	GYM25R/L○-D20	2.0	20	27.0	0	83	61.6
C4-GYHER/LM00-M25R/L	GYM25R/L○-E06	2.5	6	27.0	0	69	47.6
C4-GYHER/LM00-M25R/L	GYM25R/L○-E12	2.5	12	27.0	0	77	55.6
C4-GYHER/LM00-M25R/L	GYM25R/L○-E20	2.5	20	27.0	0	83	61.6
C4-GYHER/LM00-M25R/L	GYM25R/L○-F06	3.0	6	27.0	0	69	47.6
C4-GYHER/LM00-M25R/L	GYM25R/L○-F12	3.0	12	27.0	0	77	55.6
C4-GYHER/LM00-M25R/L	GYM25R/L○-F20	3.0	20	27.0	0	83	61.6
C4-GYHER/LM00-M25R/L	GYM25R/L○-G08	4.0	8	27.0	0	71	49.6
C4-GYHER/LM00-M25R/L	GYM25R/L○-G14	4.0	14	27.0	0	77	55.6
C4-GYHER/LM00-M25R/L	GYM25R/L○-G25	4.0	25	27.0	0	88	66.6
C4-GYHER/LM00-M25R/L	GYM25R/L○-H08	5.0	8	27.0	0	71	49.6
C4-GYHER/LM00-M25R/L	GYM25R/L○-H14	5.0	14	27.0	0	77	55.6
C4-GYHER/LM00-M25R/L	GYM25R/L○-H25	5.0	25	27.0	0	88	66.6
C4-GYHER/LM00-M25R/L	GYM25R/L○-J08	6.0	8	27.0	0	71	49.6
C4-GYHER/LM00-M25R/L	GYM25R/L○-J14	6.0	14	27.0	0	77	55.6
C4-GYHER/LM00-M25R/L	GYM25R/L○-J25	6.0	25	27.0	0	88	66.6

*Modular blade type: Blades for face machining indicate a code for the minimum face grooving diameter. Example: GYM25RD-D12-040

The "○" symbol is a position to insert the letter "A" for external diameter machining or "D" for face machining.

Note 1) The indicated dimensions are values for standard inserts (GM breakers). If other inserts are mounted, LF and LH may differ.

★ : Inventory maintained in Japan.

(mm)







Holder Type	Modular Blade Type	Standard CW	CDX	WF	HF	LF	LH
C5-GYHER/LM00-M25R/L	GYM25R/L-D06	2.0	6	35.0	0	69	47.6
C5-GYHER/LM00-M25R/L	GYM25R/L-D12	2.0	12	35.0	0	77	55.6
C5-GYHER/LM00-M25R/L	GYM25R/L-D20	2.0	20	35.0	0	83	61.6
C5-GYHER/LM00-M25R/L	GYM25R/L-E06	2.5	6	35.0	0	69	47.6
C5-GYHER/LM00-M25R/L	GYM25R/L-E12	2.5	12	35.0	0	77	55.6
C5-GYHER/LM00-M25R/L	GYM25R/L-E20	2.5	20	35.0	0	83	61.6
C5-GYHER/LM00-M25R/L	GYM25R/L-F06	3.0	6	35.0	0	69	47.6
C5-GYHER/LM00-M25R/L	GYM25R/L-F12	3.0	12	35.0	0	77	55.6
C5-GYHER/LM00-M25R/L	GYM25R/L-F20	3.0	20	35.0	0	83	61.6
C5-GYHER/LM00-M25R/L	GYM25R/L-G08	4.0	8	35.0	0	71	49.6
C5-GYHER/LM00-M25R/L	GYM25R/L-G14	4.0	14	35.0	0	77	55.6
C5-GYHER/LM00-M25R/L	GYM25R/L-G25	4.0	25	35.0	0	88	66.6
C5-GYHER/LM00-M25R/L	GYM25R/L-H08	5.0	8	35.0	0	71	49.6
C5-GYHER/LM00-M25R/L	GYM25R/L-H14	5.0	14	35.0	0	77	55.6
C5-GYHER/LM00-M25R/L	GYM25R/L-H25	5.0	25	35.0	0	88	66.6
C5-GYHER/LM00-M25R/L	GYM25R/L-J08	6.0	8	35.0	0	71	49.6
C5-GYHER/LM00-M25R/L	GYM25R/L-J14	6.0	14	35.0	0	77	55.6
C5-GYHER/LM00-M25R/L	GYM25R/L-J25	6.0	25	35.0	0	88	66.6
C6-GYHER/LM00-M25R/L	GYM25R/L-D06	2.0	6	45.0	0	71	47.6
C6-GYHER/LM00-M25R/L	GYM25R/L-D12	2.0	12	45.0	0	79	55.6
C6-GYHER/LM00-M25R/L	GYM25R/L-D20	2.0	20	45.0	0	85	61.6
C6-GYHER/LM00-M25R/L	GYM25R/L-E06	2.5	6	45.0	0	71	47.6
C6-GYHER/LM00-M25R/L	GYM25R/L-E12	2.5	12	45.0	0	79	55.6
C6-GYHER/LM00-M25R/L	GYM25R/L-E20	2.5	20	45.0	0	85	61.6
C6-GYHER/LM00-M25R/L	GYM25R/L-F06	3.0	6	45.0	0	71	47.6
C6-GYHER/LM00-M25R/L	GYM25R/L-F12	3.0	12	45.0	0	79	55.6
C6-GYHER/LM00-M25R/L	GYM25R/L-F20	3.0	20	45.0	0	85	61.6
C6-GYHER/LM00-M25R/L	GYM25R/L-G08	4.0	8	45.0	0	73	49.6
C6-GYHER/LM00-M25R/L	GYM25R/L-G14	4.0	14	45.0	0	79	55.6
C6-GYHER/LM00-M25R/L	GYM25R/L-G25	4.0	25	45.0	0	90	66.6
C6-GYHER/LM00-M25R/L	GYM25R/L-H08	5.0	8	45.0	0	73	49.6
C6-GYHER/LM00-M25R/L	GYM25R/L-H14	5.0	14	45.0	0	79	55.6
C6-GYHER/LM00-M25R/L	GYM25R/L-H25	5.0	25	45.0	0	90	66.6
C6-GYHER/LM00-M25R/L	GYM25R/L-J08	6.0	8	45.0	0	73	49.6
C6-GYHER/LM00-M25R/L	GYM25R/L-J14	6.0	14	45.0	0	79	55.6
C6-GYHER/LM00-M25R/L	GYM25R/L-J25	6.0	25	45.0	0	90	66.6

*Modular blade type: Blades for face machining indicate a code for the minimum face grooving diameter. Example: GYM25RD-D12-040

The "○" symbol is a position to insert the letter "A" for external diameter machining or "D" for face machining.

Note 1) The indicated dimensions are values for standard inserts (GM breakers). If other inserts are mounted, LF and LH may differ.

SPARE PARTS

											
Order Number	Pcs.	Order Number	Pcs.	Order Number	Pcs.	Order Number	Pcs.	Order Number	Order Number		
GY06013M	1	TS55	5	HSD05004S	1	NZ22042080S	1	TKY25D	TKY30R		

* Clamp Torque (N · m) : GY06013M=6.0, TS55=5.0

Nozzle Exchange Key : NZKH050S

IDENTIFICATION	> F008, F010
INSERTS	> F012 – F015
CUTTING CONDITIONS	> F096, F104
CAUTION FOR USE	> F100, F106

GY SERIES (EXTERNAL / FACE GROOVING)

PSC 90° type holder

NEW

Note 1) Please order the modular blade and modular holder separately.

Note 2) Please set the left hand modular blade at the right hand holder and the right hand modular blade at the left hand holder.

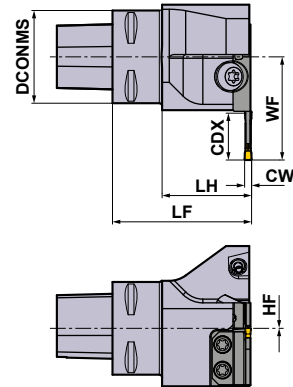

Left hand tool holder shown.

(mm)

Order Number	Stock	Hand (R/L)	Coolant	Mounting Size	DCONMS	CW
C4-GYHERM90-M25L	★	R	External	PSC40	40	2.0–6.35
C4-GYHELM90-M25R	★	L	External	PSC40	40	2.0–6.35
C5-GYHERM90-M25L	★	R	External	PSC50	50	2.0–6.35
C5-GYHELM90-M25R	★	L	External	PSC50	50	2.0–6.35
C6-GYHERM90-M25L	★	R	External	PSC60	60	2.0–6.35
C6-GYHELM90-M25R	★	L	External	PSC60	60	2.0–6.35

GROOVING / CUTTING OFF

Set Dimensions with Modular Blades

Holder Type	Modular Blade Type	Standard CW	CDX	WF	HF	LF	LH
C4-GYHER/LM90-M25L/R	GYM25L/R-D06	2.0	6	30.5	0	60	38.6
C4-GYHER/LM90-M25L/R	GYM25L/R-D12	2.0	12	38.5	0	60	38.6
C4-GYHER/LM90-M25L/R	GYM25L/R-D20	2.0	20	44.5	0	60	38.6
C4-GYHER/LM90-M25L/R	GYM25L/R-E06	2.5	6	30.5	0	60	38.6
C4-GYHER/LM90-M25L/R	GYM25L/R-E12	2.5	12	38.5	0	60	38.6
C4-GYHER/LM90-M25L/R	GYM25L/R-E20	2.5	20	44.5	0	60	38.6
C4-GYHER/LM90-M25L/R	GYM25L/R-F06	3.0	6	30.5	0	60	38.6
C4-GYHER/LM90-M25L/R	GYM25L/R-F12	3.0	12	38.5	0	60	38.6
C4-GYHER/LM90-M25L/R	GYM25L/R-F20	3.0	20	44.5	0	60	38.6
C4-GYHER/LM90-M25L/R	GYM25L/R-G08	4.0	8	32.5	0	60	38.6
C4-GYHER/LM90-M25L/R	GYM25L/R-G14	4.0	14	38.5	0	60	38.6
C4-GYHER/LM90-M25L/R	GYM25L/R-G25	4.0	25	49.5	0	60	38.6
C4-GYHER/LM90-M25L/R	GYM25L/R-H08	5.0	8	32.5	0	60	38.6
C4-GYHER/LM90-M25L/R	GYM25L/R-H14	5.0	14	38.5	0	60	38.6
C4-GYHER/LM90-M25L/R	GYM25L/R-H25	5.0	25	49.5	0	60	38.6
C4-GYHER/LM90-M25L/R	GYM25L/R-J08	6.0	8	32.5	0	60	38.6
C4-GYHER/LM90-M25L/R	GYM25L/R-J14	6.0	14	38.5	0	60	38.6
C4-GYHER/LM90-M25L/R	GYM25L/R-J25	6.0	25	49.5	0	60	38.6

*Modular blade type: Blades for face machining indicate a code for the minimum face grooving diameter. Example: GYM25RD-D12-040

The "○" symbol is a position to insert the letter "A" for external diameter machining or "D" for face machining.

Note 1) The indicated dimensions are values for standard inserts (GM breakers). If other inserts are mounted, LF and LH may differ.

★ : Inventory maintained in Japan.







(mm)

Holder Type	Modular Blade Type	Standard CW	CDX	WF	HF	LF	LH
C5-GYHER/LM90-M25L/R	GYM25L/R○-D06	2.0	6	33.0	0	60	38.6
C5-GYHER/LM90-M25L/R	GYM25L/R○-D12	2.0	12	41.0	0	60	38.6
C5-GYHER/LM90-M25L/R	GYM25L/R○-D20	2.0	20	47.0	0	60	38.6
C5-GYHER/LM90-M25L/R	GYM25L/R○-E06	2.5	6	33.0	0	60	38.6
C5-GYHER/LM90-M25L/R	GYM25L/R○-E12	2.5	12	41.0	0	60	38.6
C5-GYHER/LM90-M25L/R	GYM25L/R○-E20	2.5	20	47.0	0	60	38.6
C5-GYHER/LM90-M25L/R	GYM25L/R○-F06	3.0	6	33.0	0	60	38.6
C5-GYHER/LM90-M25L/R	GYM25L/R○-F12	3.0	12	41.0	0	60	38.6
C5-GYHER/LM90-M25L/R	GYM25L/R○-F20	3.0	20	47.0	0	60	38.6
C5-GYHER/LM90-M25L/R	GYM25L/R○-G08	4.0	8	35.0	0	60	38.6
C5-GYHER/LM90-M25L/R	GYM25L/R○-G14	4.0	14	41.0	0	60	38.6
C5-GYHER/LM90-M25L/R	GYM25L/R○-G25	4.0	25	52.0	0	60	38.6
C5-GYHER/LM90-M25L/R	GYM25L/R○-H08	5.0	8	35.0	0	60	38.6
C5-GYHER/LM90-M25L/R	GYM25L/R○-H14	5.0	14	41.0	0	60	38.6
C5-GYHER/LM90-M25L/R	GYM25L/R○-H25	5.0	25	52.0	0	60	38.6
C5-GYHER/LM90-M25L/R	GYM25L/R○-J08	6.0	8	35.0	0	60	38.6
C5-GYHER/LM90-M25L/R	GYM25L/R○-J14	6.0	14	41.0	0	60	38.6
C5-GYHER/LM90-M25L/R	GYM25L/R○-J25	6.0	25	52.0	0	60	38.6
C6-GYHER/LM90-M25L/R	GYM25L/R○-D06	2.0	6	40.0	0	70	46.6
C6-GYHER/LM90-M25L/R	GYM25L/R○-D12	2.0	12	48.0	0	70	46.6
C6-GYHER/LM90-M25L/R	GYM25L/R○-D20	2.0	20	54.0	0	70	46.6
C6-GYHER/LM90-M25L/R	GYM25L/R○-E06	2.5	6	40.0	0	70	46.6
C6-GYHER/LM90-M25L/R	GYM25L/R○-E12	2.5	12	48.0	0	70	46.6
C6-GYHER/LM90-M25L/R	GYM25L/R○-E20	2.5	20	54.0	0	70	46.6
C6-GYHER/LM90-M25L/R	GYM25L/R○-F06	3.0	6	40.0	0	70	46.6
C6-GYHER/LM90-M25L/R	GYM25L/R○-F12	3.0	12	48.0	0	70	46.6
C6-GYHER/LM90-M25L/R	GYM25L/R○-F20	3.0	20	54.0	0	70	46.6
C6-GYHER/LM90-M25L/R	GYM25L/R○-G08	4.0	8	42.0	0	70	46.6
C6-GYHER/LM90-M25L/R	GYM25L/R○-G14	4.0	14	48.0	0	70	46.6
C6-GYHER/LM90-M25L/R	GYM25L/R○-G25	4.0	25	59.0	0	70	46.6
C6-GYHER/LM90-M25L/R	GYM25L/R○-H08	5.0	8	42.0	0	70	46.6
C6-GYHER/LM90-M25L/R	GYM25L/R○-H14	5.0	14	48.0	0	70	46.6
C6-GYHER/LM90-M25L/R	GYM25L/R○-H25	5.0	25	59.0	0	70	46.6
C6-GYHER/LM90-M25L/R	GYM25L/R○-J08	6.0	8	42.0	0	70	46.6
C6-GYHER/LM90-M25L/R	GYM25L/R○-J14	6.0	14	48.0	0	70	46.6
C6-GYHER/LM90-M25L/R	GYM25L/R○-J25	6.0	25	59.0	0	70	46.6

*Modular blade type: Blades for face machining indicate a code for the minimum face grooving diameter. Example: GYM25RD-D12-040
The "○" symbol is a position to insert the letter "A" for external diameter machining or "D" for face machining.

Note 1) The indicated dimensions are values for standard inserts (GM breakers). If other inserts are mounted, LF and LH may differ.

SPARE PARTS

											
Order Number	Pcs.	Order Number	Pcs.	Order Number	Pcs.	Order Number	Pcs.	Order Number	Order Number		
GY06013M	1	TS55	5	HSD05004S	1	NZ22042080S	1	TKY25D		TKY30R	

* Clamp Torque (N · m) : GY06013M=6.0, TS55=5.0

Nozzle Exchange Key : NZKH050S

IDENTIFICATION	> F008, F010
INSERTS	> F012 – F015
CUTTING CONDITIONS	> F096, F104
CAUTION FOR USE	> F100, F106

GY SERIES (FOR RECESSING)

PSC For 50° recessing holder **NEW**

Note 1) Please order the modular blade and modular holder separately.

Note 2) Please set the left hand modular blade at the right hand holder and the right hand modular blade at the left hand holder.

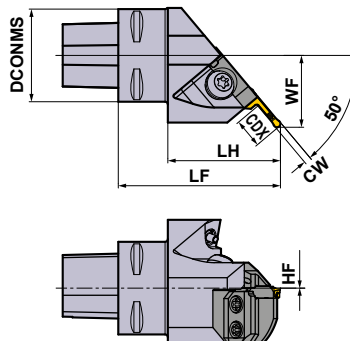

Left hand tool holder shown.

(mm)

Order Number	Stock	Hand (R/L)	Coolant	Mounting Size	DCONMS	CW
C4-GYHERM50-M25L	★	R	External	PSC40	40	2.0-6.35
C4-GYHELM50-M25R	★	L	External	PSC40	40	2.0-6.35
C5-GYHERM50-M25L	★	R	External	PSC50	50	2.0-6.35
C5-GYHELM50-M25R	★	L	External	PSC50	50	2.0-6.35
C6-GYHERM50-M25L	★	R	External	PSC60	60	2.0-6.35
C6-GYHELM50-M25R	★	L	External	PSC60	60	2.0-6.35

GROOVING / CUTTING OFF

SPARE PARTS

*		*									
Order Number	Pcs.	Order Number	Pcs.	Order Number	Pcs.	Order Number	Pcs.	Order Number	Order Number		
GY06013M	1	TS55	4	HSD05004S	1	NZ22042080S	1	TKY25D	TKY30R		

* Clamp Torque (N · m) : GY06013M=6.0, TS55=5.0

Nozzle Exchange Key : NZKH050S

★ : Inventory maintained in Japan.

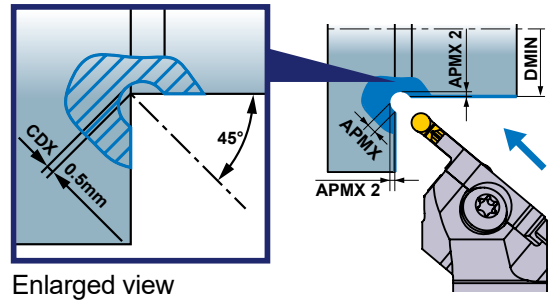

Enlarged view

Set Dimensions with Modular Blades

(mm)

Holder Type	Modular Blade Type	Standard CW	CDX	DMIN	APMX	APMX2	WF	HF	LF	LH
C4-GYHER/LM50-M25L/R	GYM25L/RC-D005	2.0	0.5	30	1.50	0.646	30.6	0	70.2	48.8
C4-GYHER/LM50-M25L/R	GYM25L/RC-E005	2.5	0.5	30	1.75	0.720	30.8	0	70.1	48.7
C4-GYHER/LM50-M25L/R	GYM25L/RC-F005	3.0	0.5	30	2.00	0.793	31.0	0	70.0	48.6
C4-GYHER/LM50-M25L/R	GYM25L/RC-G005	4.0	0.5	20	2.50	0.939	31.4	0	69.8	48.4
C4-GYHER/LM50-M25L/R	GYM25L/RC-H005	5.0	0.5	20	2.88	1.049	31.8	0	69.6	48.2
C4-GYHER/LM50-M25L/R	GYM25L/RC-J005	6.0	0.5	20	3.50	1.232	32.4	0	69.4	48.0
C5-GYHER/LM50-M25L/R	GYM25L/RC-D005	2.0	0.5	30	1.50	0.646	32.6	0	70.2	48.8
C5-GYHER/LM50-M25L/R	GYM25L/RC-E005	2.5	0.5	30	1.75	0.720	32.8	0	70.1	48.7
C5-GYHER/LM50-M25L/R	GYM25L/RC-F005	3.0	0.5	30	2.00	0.793	33.0	0	70.0	48.6
C5-GYHER/LM50-M25L/R	GYM25L/RC-G005	4.0	0.5	20	2.50	0.939	33.4	0	69.8	48.4
C5-GYHER/LM50-M25L/R	GYM25L/RC-H005	5.0	0.5	20	2.88	1.049	33.8	0	69.6	48.2
C5-GYHER/LM50-M25L/R	GYM25L/RC-J005	6.0	0.5	20	3.50	1.232	34.4	0	69.4	48.0
C6-GYHER/LM50-M25L/R	GYM25L/RC-D005	2.0	0.5	30	1.50	0.646	39.6	0	70.2	46.8
C6-GYHER/LM50-M25L/R	GYM25L/RC-E005	2.5	0.5	30	1.75	0.720	39.8	0	70.1	46.7
C6-GYHER/LM50-M25L/R	GYM25L/RC-F005	3.0	0.5	30	2.00	0.793	40.0	0	70.0	46.6
C6-GYHER/LM50-M25L/R	GYM25L/RC-G005	4.0	0.5	20	2.50	0.939	40.4	0	69.8	46.4
C6-GYHER/LM50-M25L/R	GYM25L/RC-H005	5.0	0.5	20	2.88	1.049	40.8	0	69.6	46.2
C6-GYHER/LM50-M25L/R	GYM25L/RC-J005	6.0	0.5	20	3.50	1.232	41.4	0	69.4	46.0

DMIN = Min. Cut Diameter

*Modular blade type: Blades for face machining indicate a code for the minimum face grooving diameter. Example: GYM25RD-D12-040
The "○" symbol is a position to insert the letter "A" for external diameter machining or "D" for face machining.

Note 1) The indicated dimensions are values for standard inserts (BM breakers). If other inserts are mounted, LF and LH may differ.

F

GROOVING / CUTTING OFF

IDENTIFICATION	> F008, F010
INSERTS	> F015
CUTTING CONDITIONS	> F099
CAUTION FOR USE	> F099

F095

GROOVING / CUTTING OFF

RECOMMENDED CUTTING SPEED [For External Grooving / Cutting Off]

Work Material	Hardness	Grade	Cutting Speed (m/min)								
			50	100	150	200	250	300	500		
P Mild Steel	≤160HB	VP20RT		100		220					
		VP10RT		110		230					
		NX2525		90		210					
	Carbon Steel Alloy Steel	160-280HB	VP20RT		80		180				
			VP10RT		90		190				
			MY5015		110		250				
			NX2525		70		170				
		280HB≤	VP20RT		60		140				
			VP10RT		70		150				
			MY5015		90		210				
NX2525		55		135							
M Stainless Steel	≤270HB	VP20RT		60		140					
		VP10RT		70		150					
K Gray Cast Iron	Tensile Strength ≤300MPa	VP20RT		80		180					
		VP10RT		90		180					
		MY5015		140		300					
	Ductile Cast Iron	Tensile Strength ≤800MPa	VP20RT		60		140				
			VP10RT		70		150				
			MY5015		90		210				
S Heat Resistant Alloy Titanium Alloy	-	MP9015		40		100					
		MP9025		30		90					
		VP20RT		30		60					
		VP10RT/ RT9010		40		70					
H Hardened steel	50HRC≤	BC8110		80		120					
N Aluminium Alloy	Content Si<5%	RT9010					200		500		
	Content 5%≤Si≤10%	RT9010					200		500		
	Content Si>10%	RT9010		100		200					

Note 1) For RT9010, VP10RT, VP20RT and MY5015, wet cutting is recommended.

RECOMMENDED CUTTING CONDITIONS [For External Grooving / Cutting Off]

*Below are the recommended cutting conditions when using the modular holder GYHR/L2525M00/90-M25R/L with the modular blade GYM25R/LA-○○○.

Recommended feed rate and depth of cut

GU BREAKER

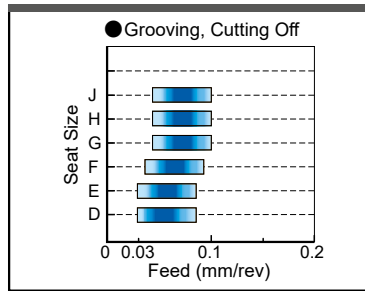

GS BREAKER

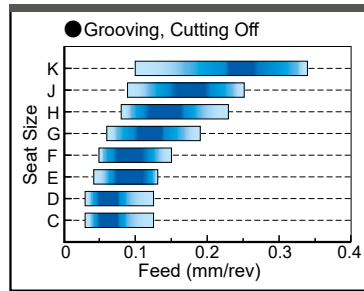

■ : 1st recommended area

Seat Size			
	Insert Width (mm)		Insert Width (mm)
C	1.50	G	4.00
			4.24
D	2.00	H	4.75
	2.24		5.00
E	2.39		6.00
	2.50	J	6.31
	2.74		6.35
F	3.00		
	3.18	K	8.00
	3.24		

GM BREAKER

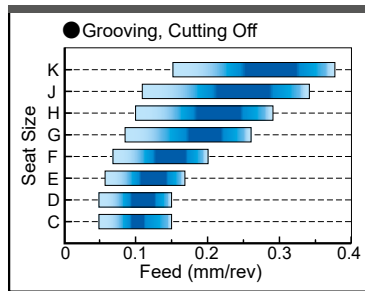

GL BREAKER

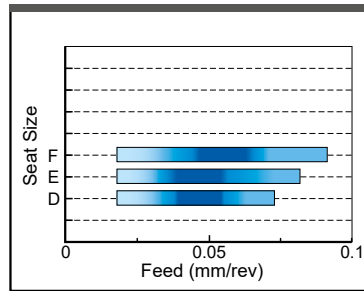

FLAT TOP GFGS (CBN)

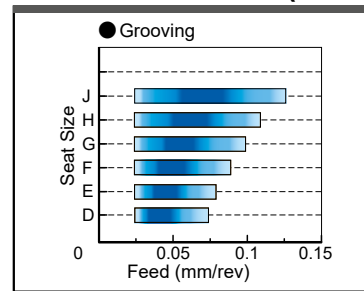

MF BREAKER

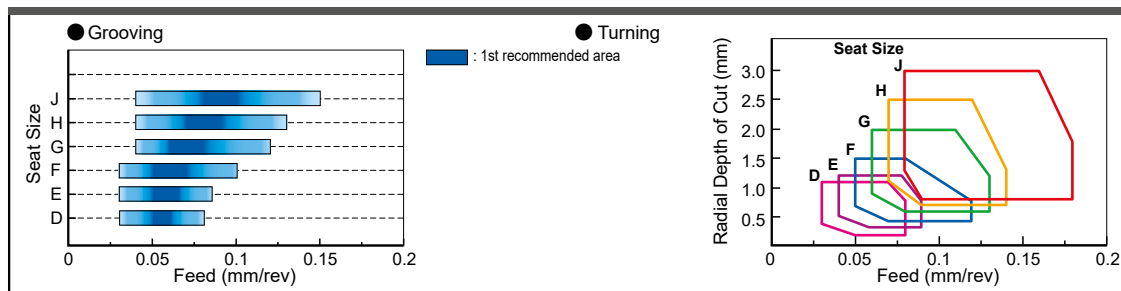

MS BREAKER

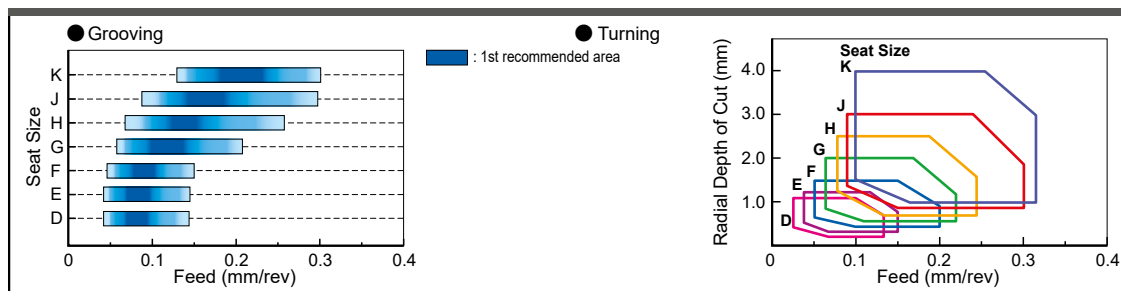

MM BREAKER

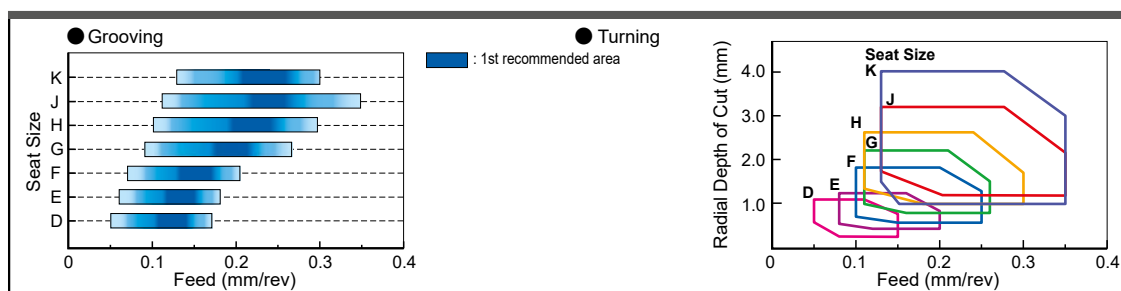

T

GROOVING / CUTTING OFF

GROOVING / CUTTING OFF

Recommended feed rate and depth of cut

BM BREAKER

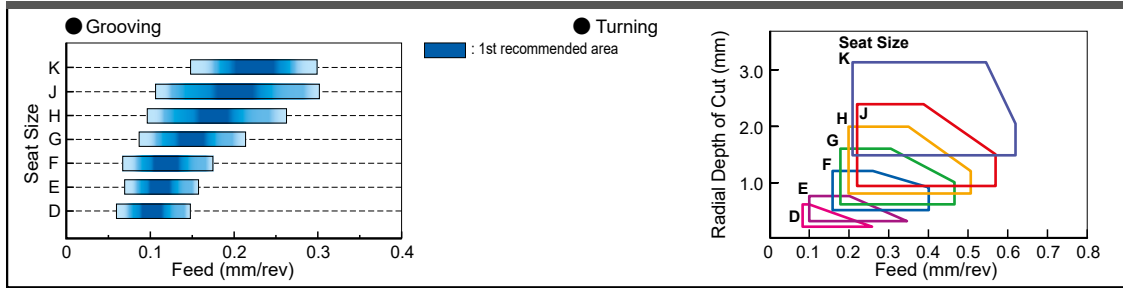

Seat Size	
Insert Width (mm)	
C	1.50
D	2.00
	2.24
E	2.39
	2.50
F	2.74
	3.00
G	3.18
	3.24
H	4.00
	4.24
I	4.75
	5.00
J	5.24
	6.00
K	6.31
	6.35
	8.00

Note 1) When using a combination as shown below, decrease the recommended feed rate by 20% and 40% respectively.

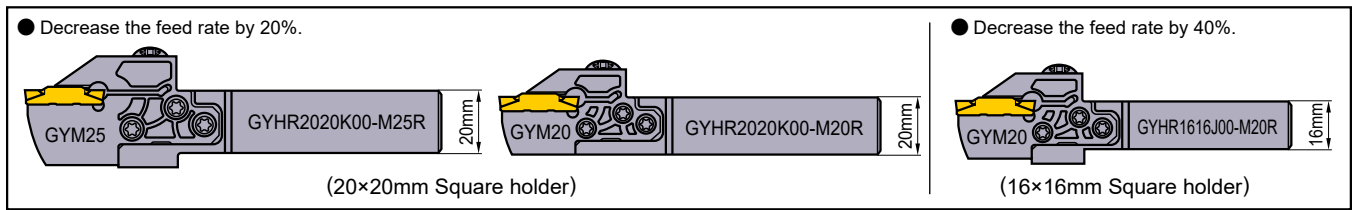

In the case of monoblock type holder for Swiss style lathes

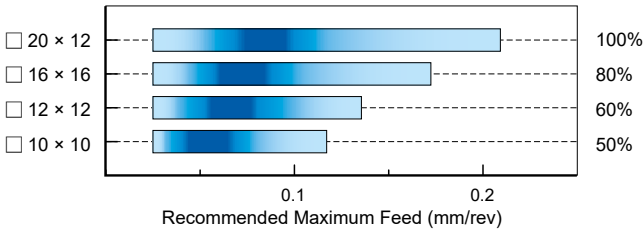

Please refer to the tables above on recommended cutting conditions for external grooving and cutting off. Apply the percentage ratio shown on each shank size with the values in the table.

LIMITATION OF THE MAXIMUM GROOVE DEPTH [For External Grooving]

● When using the modular blade GYM○R/LA-○○○
The maximum groove depth is not limited by the workpiece diameter.

● When using the modular blade GYM○R/LB-○○○
The maximum groove depth is limited by the workpiece diameter.

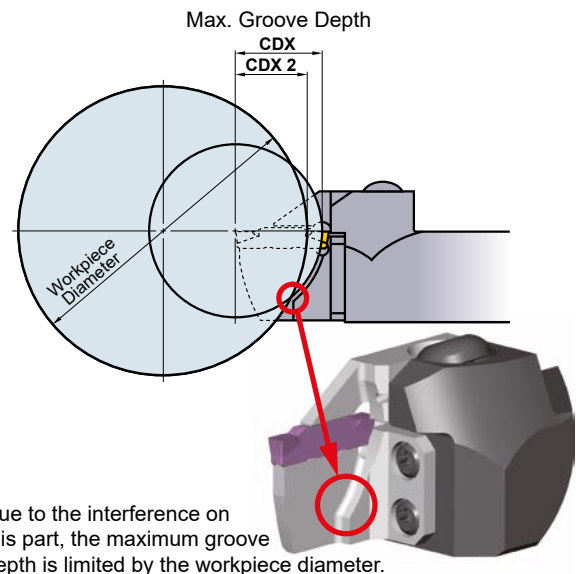
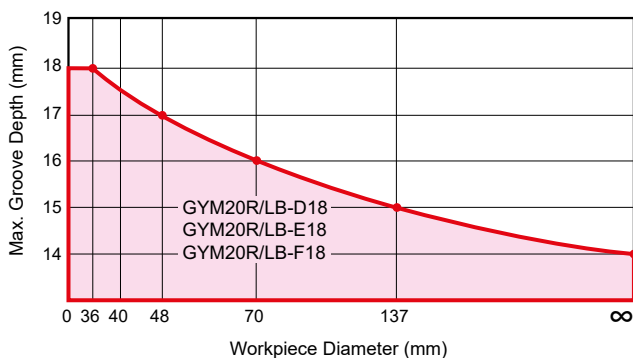

RECOMMENDED CUTTING SPEED (m/min) [For External Recessing]

Work Material	Hardness	Grade	Cutting Speed (m/min)							
			50	100	150	200	250			
P	Mild Steel	VP20RT	80		180					
		VP10RT	90		190					
	Carbon Steel Alloy Steel	VP20RT	60		140					
		VP10RT	70		150					
		MY5015	90		210					
		NX2525	55		135					
	Carbon Steel Alloy Steel	VP20RT	50		110					
		VP10RT	60		120					
		MY5015	80		160					
		NX2525	45		105					
	M	Stainless Steel	VP20RT	50		110				
			VP10RT	60		120				
K	Gray Cast Iron	VP20RT	60		140					
		VP10RT	70		150					
		MY5015	90		210					
	Ductile Cast Iron	VP20RT	50		110					
		VP10RT	60		120					
		MY5015	80		160					
S	Titanium Alloy Heat Resistant Alloy	MP9015	40		100					
		MP9025	30		90					
		VP20RT	30		60					
		VP10RT	40		70					

Note 1) For VP10RT, VP20RT and MY5015, wet cutting is recommended.

DISTANCE FROM THE WORKPIECE TO THE RECESS DEPTH

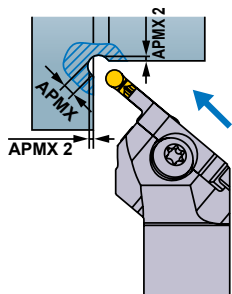

Cutting Width CW (mm)	Recessing Depth APMX (mm)	Distance workpiece to the recess depth APMX 2 (mm)
2.00	1.50	0.646
2.50	1.75	0.720
3.00	2.00	0.793
3.18	2.09	0.819
4.00	2.50	0.939
4.75	2.88	1.049
5.00	3.00	1.086
6.00	3.50	1.232
6.35	3.68	1.283

BM BREAKER

Minimum grooving diameter

Ensure the tool is suitable for the diameter being machined. Refer to the Min. Grooving Diameter DMIN as shown in the table on page F036 to avoid a collision with the workpiece as shown below.

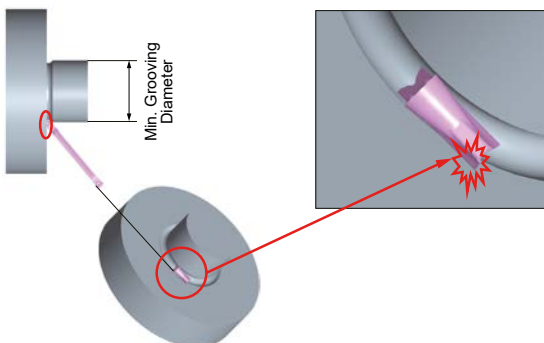

Recommended feed rate and depth of cut

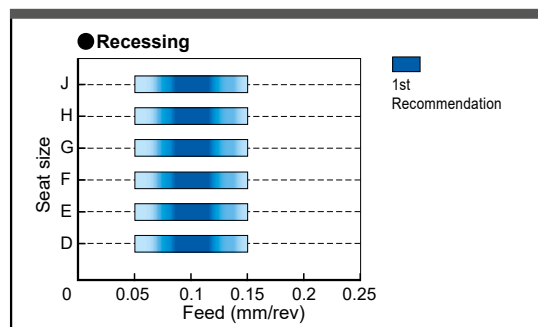

TOOL SELECTION

Notes when selecting the tool body

Modular holder

● To ensure sufficient clamping rigidity, select a modular holder with the largest possible shank size.

Modular blade (1)

● If there is no restriction for use, select the largest modular blade for the same shank size.

Modular blade (2)

● Select the shortest possible blade suitable for the application.

Modular blade (3)

● Select the shortest possible blade suitable for the application.

Notes when setting the tool

Setting of cutting edge height

<Grooving/Cross-feed machining>
Set the cutting edge height to $\pm 0.1\text{mm}$ parallel to the central axis.

<Cutting off>
Set the cutting edge height to $0\text{--}+0.2\text{mm}$ parallel to the central axis.

Tool body setting angle

● Set the insert perpendicular to the central axis.

Overhang



● When setting the tool, ensure that the overhang is as short as possible and avoid contact of the tool post with the top clamp as shown in the figures above.

MACHINING RECOMMENDATIONS

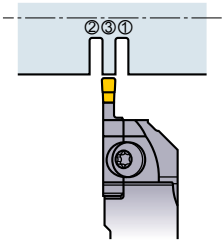
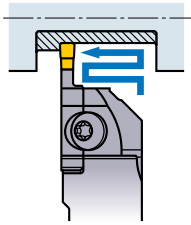
Notes on multi-functional machining (MF, MS and MM breakers)

Machining narrow grooves	Machining wide grooves
 <p>● It is recommended to carry out plunging in several passes. Following the steps above makes it difficult for chips to elongate. This also improves the accuracy of workpiece wall surface.</p>	 <p>● It is recommended that cross-feed machining is used.</p>

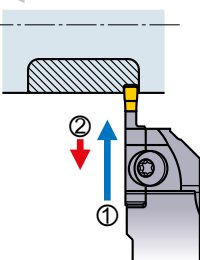
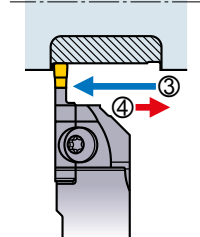
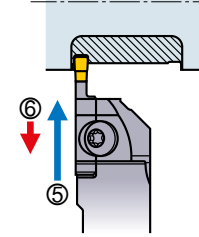
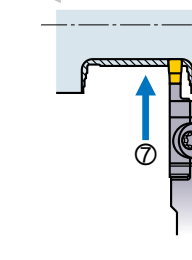
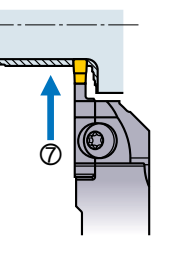
Machining wide grooves

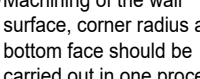
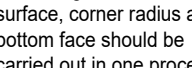
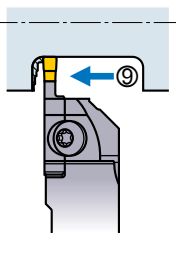
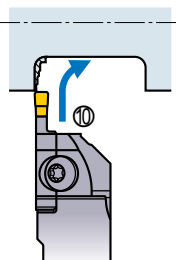
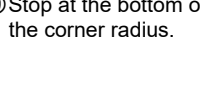
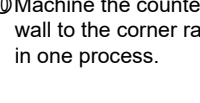
ROUGHING			FINISHING		
 <p>① Carry out grooving.</p>	 <p>② Retract the tool approx 0.1 mm.</p>	 <p>③ Carry out cross feed machining.</p>	 <p>④ Retract the tool approx 0.1 mm.</p>	 <p>⑤ Carry out grooving.</p>	 <p>⑥ Retract the tool approx 0.1 mm. * Repeat the steps ①-⑥.</p>
			 <p>⑦ Carry out grooving to the end point of the corner radius.</p>	 <p>⑧ Machining of the wall surface, corner radius and bottom face should be carried out in one process.</p>	
FINISHING			Precautions when finishing walls		
 <p>⑨ Stop at the bottom of the corner radius.</p>	 <p>⑩ Machine the counter wall to the corner radius in one process.</p>	 <p>⑪ Finish machining.</p>	 <p>● To produce high accuracy walls using MS or MM breaker insert, do not carry out back turning. Plunging is recommended.</p>		

Wall machining

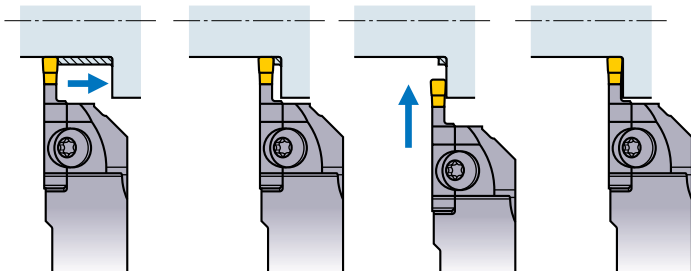

● When machining a wall, chip jamming can occur. In this case, stop cross feed machining just before the wall (at a point less than the insert width) then remove the remaining material by plunging.

Machining of a ring section

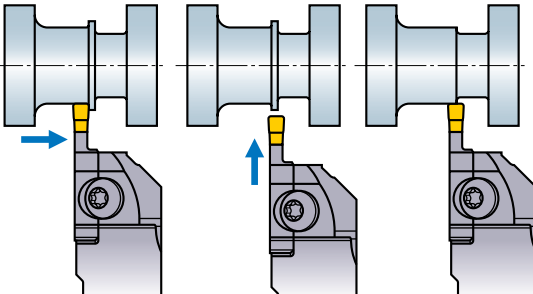

● When a ring remains in a cross feed end process, finish cross feed machining 1–1.5 mm short of the end point, then remove the ring by plunging.

GROOVING / CUTTING OFF

MACHINING RECOMMENDATIONS

Notes on multi-functional machining (BM breaker)

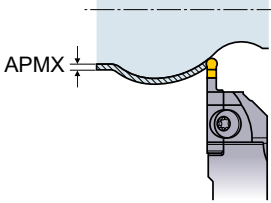
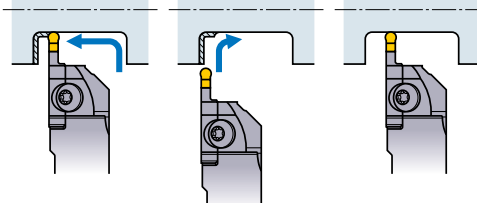
Copying	Roughing
	
<ul style="list-style-type: none"> ● With the BM breaker insert, 3 dimensional copying is possible. Set the depth of cut (APMX) to 40% less than the insert width. 	<ul style="list-style-type: none"> ● Use plunging and cross-feed machining. When machining the corner, vibration is likely to occur. To avoid this, reduce the feed by 50%.

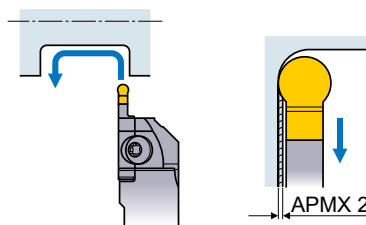
Finishing																					
	<table border="1" style="width: 100%; border-collapse: collapse;"> <thead> <tr> <th style="width: 50%;">Insert</th> <th style="width: 50%;">APMX 2 (mm)</th> </tr> </thead> <tbody> <tr><td>GY2M0200D100N-BM</td><td>0.05</td></tr> <tr><td>GY2M0250E125N-BM</td><td>0.10</td></tr> <tr><td>GY2M0300F150N-BM</td><td rowspan="2">0.15</td></tr> <tr><td>GY2M0318F159N-BM</td></tr> <tr><td>GY2M0400G200N-BM</td><td rowspan="2">0.20</td></tr> <tr><td>GY2M0475H238N-BM</td></tr> <tr><td>GY2M0500H250N-BM</td><td rowspan="2">0.24</td></tr> <tr><td>GY2M0600J300N-BM</td></tr> <tr><td>GY2M0635J318N-BM</td><td rowspan="2">0.30</td></tr> <tr><td>GY2M0800K400N-BM</td></tr> <tr><td></td><td>0.40</td></tr> </tbody> </table>	Insert	APMX 2 (mm)	GY2M0200D100N-BM	0.05	GY2M0250E125N-BM	0.10	GY2M0300F150N-BM	0.15	GY2M0318F159N-BM	GY2M0400G200N-BM	0.20	GY2M0475H238N-BM	GY2M0500H250N-BM	0.24	GY2M0600J300N-BM	GY2M0635J318N-BM	0.30	GY2M0800K400N-BM		0.40
Insert	APMX 2 (mm)																				
GY2M0200D100N-BM	0.05																				
GY2M0250E125N-BM	0.10																				
GY2M0300F150N-BM	0.15																				
GY2M0318F159N-BM																					
GY2M0400G200N-BM	0.20																				
GY2M0475H238N-BM																					
GY2M0500H250N-BM	0.24																				
GY2M0600J300N-BM																					
GY2M0635J318N-BM	0.30																				
GY2M0800K400N-BM																					
	0.40																				
<ul style="list-style-type: none"> ● Carry out finishing in one process. For the depth of cut (APMX 2) when back turning, refer to the table on the right. 																					

Notes for cutting off

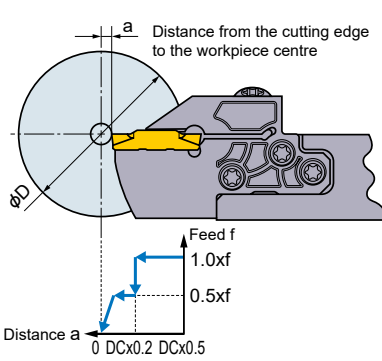
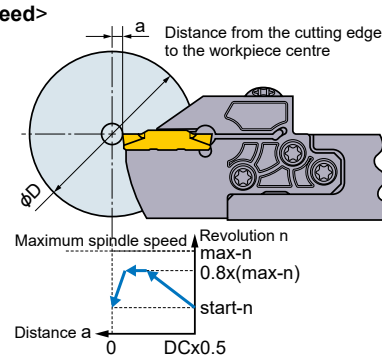
Feed	Revolution
<p><Feed></p> 	<p><Spindle speed></p> 
<ul style="list-style-type: none"> ● When the cutting edge approaches the centre, reduce the feed by 50%. ● If necessary, stop the feed prior to reaching the centre of the workpiece to prevent it falling under its own weight. 	<ul style="list-style-type: none"> ● When using constant cutting speed during a cutting off cycle, it is recommended to limit the spindle speed to 80% of maximum to ensure stability. ● To prevent the workpiece from being expelled, lower the spindle speed before finishing the grooving operation.

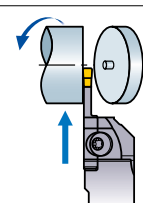
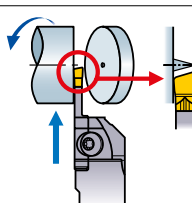
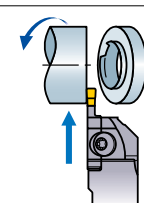
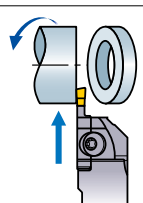
Insert	
 <p>Neutral insert</p>	 <p>Handed insert</p>
 <p>Neutral insert</p>	 <p>Handed insert</p>
<ul style="list-style-type: none"> ● When there is a centre stub on solid bar work or burrs are formed on pipe material, it is possible to decrease them by using a handed insert. With a handed insert, machining tends to be less stable when compared to using a neutral insert. Pay special attention to avoid fracturing of the cutting edge and decrease the feed when necessary. 	

Memo

A series of horizontal dashed lines for writing, spanning the width of the page.

GROOVING / CUTTING OFF

RELATIONSHIP BETWEEN THE MODULAR BLADE AND FEED PER ROTATION [For Face Grooving]

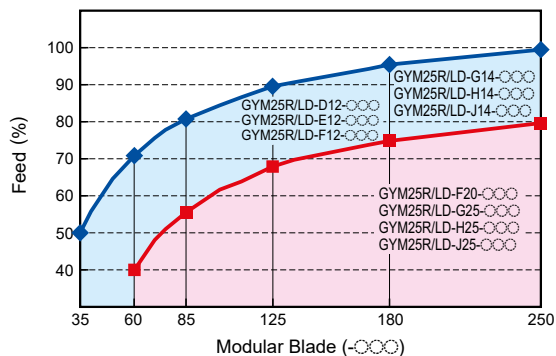

Note 1) Adjust the feed per rotation in the cutting conditions to the percentage shown in the table above.

RECOMMENDED CUTTING SPEED [For Face Grooving]

Work Material	Hardness	Grade	Cutting Speed (m/min)						
			50	100	150	200	250	300	
P Mild Steel	≤160HB	VP20RT	80 — 180						
		VP10RT	90 — 190						
		NX2525	70 — 170						
	Carbon Steel Alloy Steel	160–280HB	VP20RT	60 — 140					
			VP10RT	70 — 150					
			MY5015	90 — 210					
		280HB≤	NX2525	55 — 135					
			VP20RT	50 — 110					
			VP10RT	60 — 120					
			MY5015	80 — 160					
M Stainless Steel	≤270HB	VP20RT	50 — 110						
		VP10RT	60 — 120						
K Gray Cast Iron	Tensile Strength ≤300MPa	VP20RT	60 — 140						
		VP10RT	70 — 150						
		MY5015	90 — 210						
	Ductile Cast Iron	Tensile Strength ≤800MPa	VP20RT	50 — 110					
			VP10RT	60 — 120					
			MY5015	80 — 160					
S Heat Resistant Alloy Titanium Alloy	—	MP9015	40 — 100						
		MP9025	30 — 90						
		VP20RT	30 — 60						
		VP10RT	40 — 70						
		RT9010	40 — 70						
H Hardened Steel	50HRC≤	BC8110	60 — 120						

Note 1) For VP10RT, VP20RT and MY5015, wet cutting is recommended.

RECOMMENDED CUTTING CONDITIONS [For Face Grooving]

GROOVING

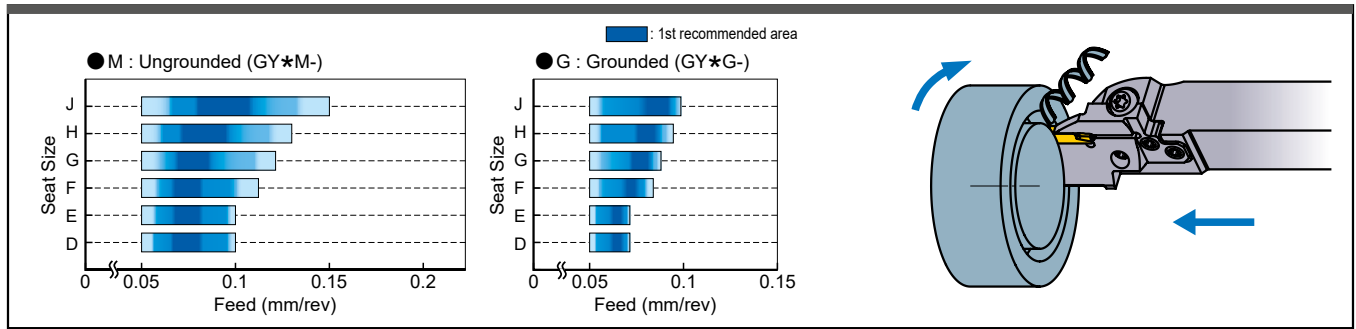

PLUNGING

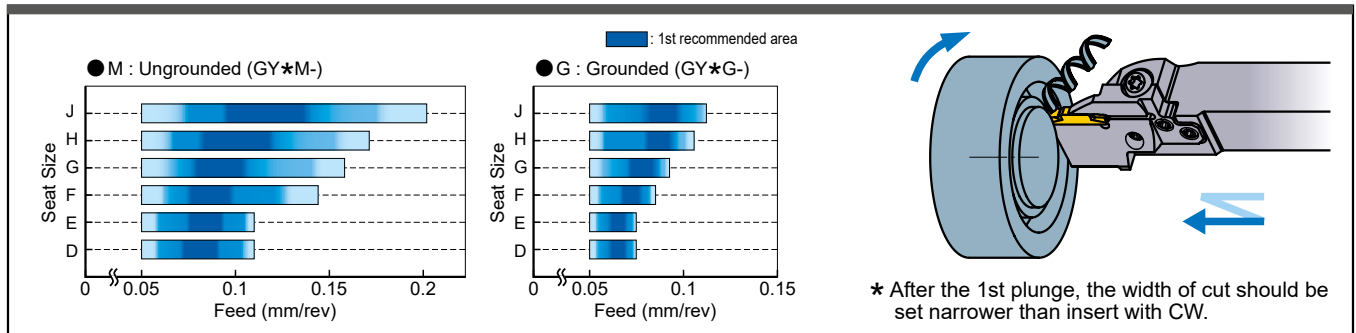

TRAVERSE MACHINING (MF BREAKER)

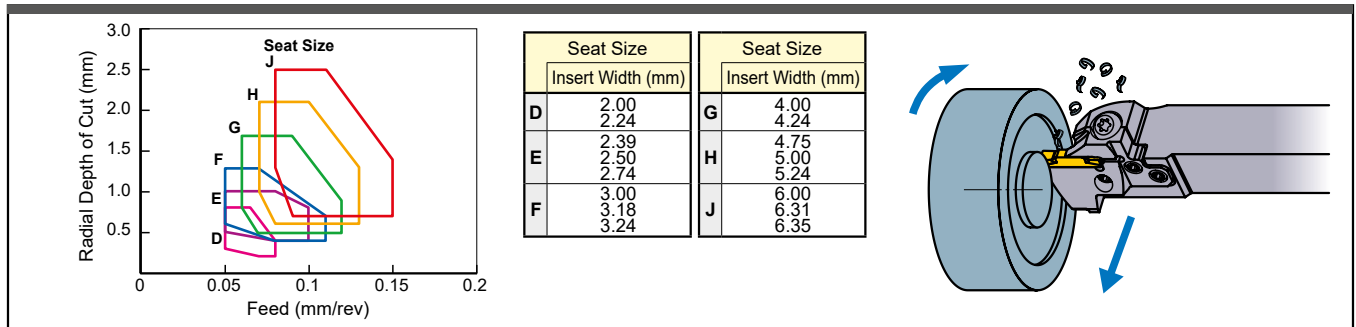

TRAVERSE MACHINING (MM/MS BREAKER)

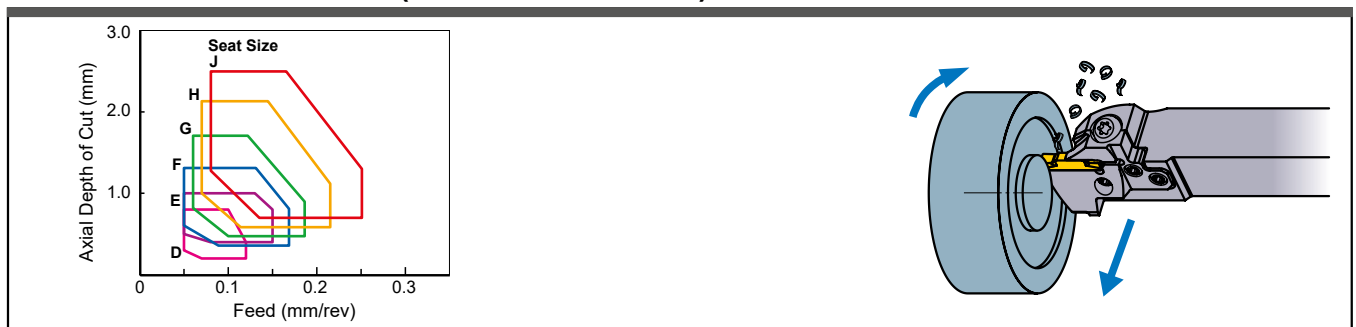

TRAVERSE MACHINING (BM BREAKER)

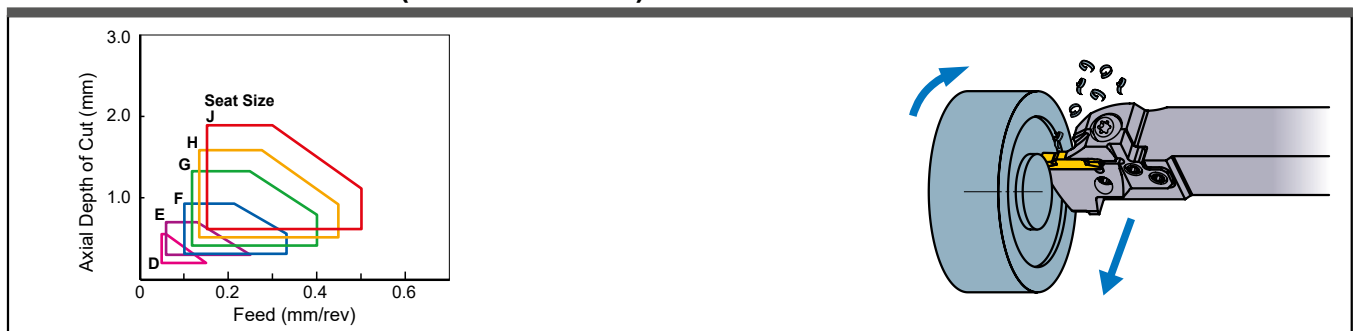

TOOL SELECTION

Notes when selecting the tool body

Modular blade (1)

- Select a modular blade for face grooving, so that the cutting diameter at the first pass is within the range of DAXN minimum and DAXX maximum that are described in the table of dimensions.

Modular blade (2)

- Select the shortest possible blade suitable for the application.

Modular blade (3)

The maximum cutting diameter

- Select the largest size blade within the maximum cutting diameter of the workpiece.
- Machine from the outer diameter towards the centre.

↓

- Increased machining stability and rigidity is possible if a modular blade with the largest possible back metal is used.

At first machine the maximum cutting diameter, there is no restriction in the cutting diameter on the remaining process.

● When plunging in several passes.

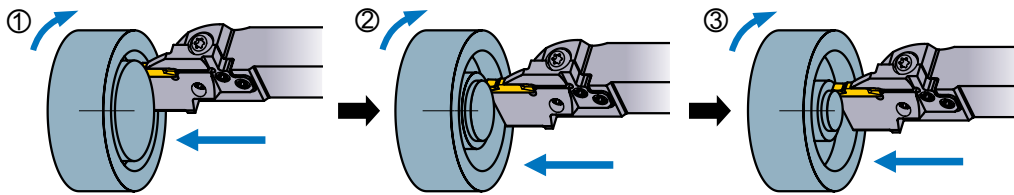

● When combining plunging and infeed machining.

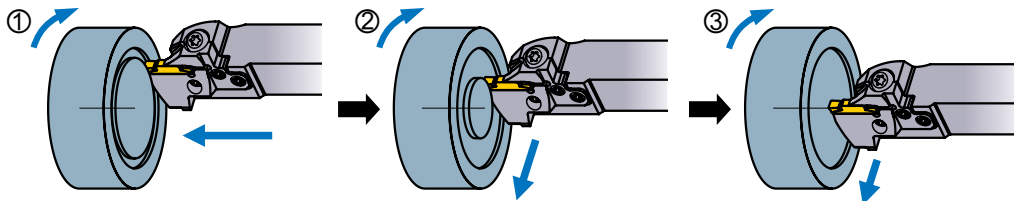

Modular holder

Modular holder

Modular holder

- Select a modular holder with the largest possible shank size to maintain mounting rigidity.

Notes when setting the tool

Setting the cutting edge height

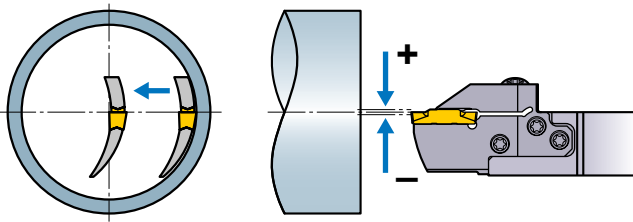

- Set the cutting edge height to $\pm 0.1\text{mm}$ parallel to the central axis.
- Cutting edge centre height check should be done by traverse machining towards the centre with a very small depth of cut and ensure that an even surface and no material remains at the centre point afterwards.

When interfering the wall of groove and the modular blade

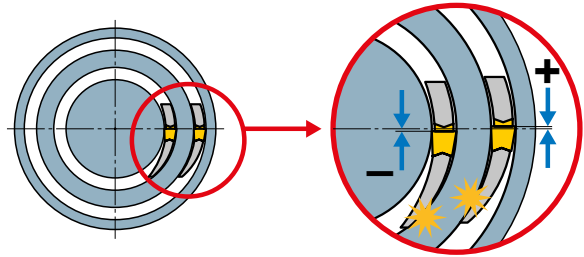

- If interference occurs even when the correct blade is used, the cutting edge height could be incorrect.
 - When interference occurs on the inner side of the blade, the cutting edge height is set too high.
 - When interference occurs on the outer side of the blade, the cutting edge height is set too low.

Setting the tool

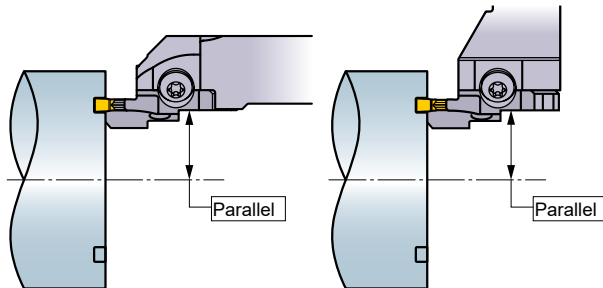

- Set the insert parallel to the central axis.

Tool overhang

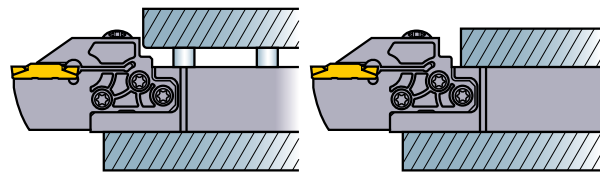

- When setting the tool, ensure that the overhang is as short as possible and avoid contact of the tool post with the top clamp as shown in the figures above.

MACHINING RECOMMENDATIONS

Notes when face grooving

- Always machine from the outer diameter towards the centre.

Machining narrow grooves

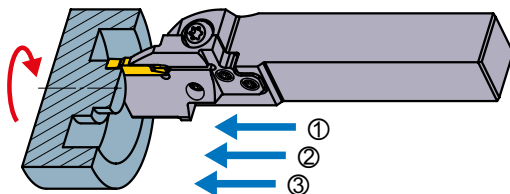

- Plunging in several passes is recommended.

Machining wide grooves

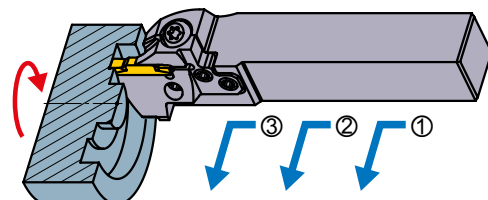

- Cross feed machining is recommended.

MACHINING RECOMMENDATIONS

Notes when face grooving

Notes on the first pass (1)

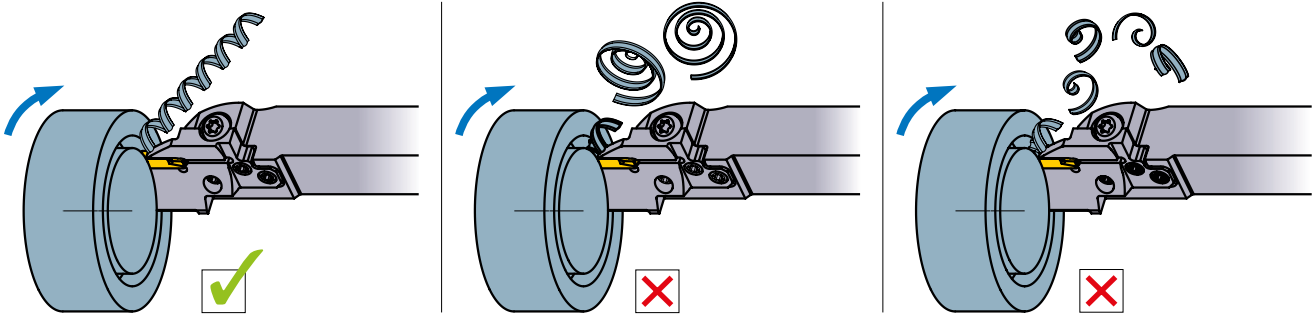

- During the first face grooving pass it is difficult to disperse broken chips and can lead to problems such as a chipped insert. Maintain longer chips that disperse easily by decreasing the feed per rotation.

Notes on the first pass (2)

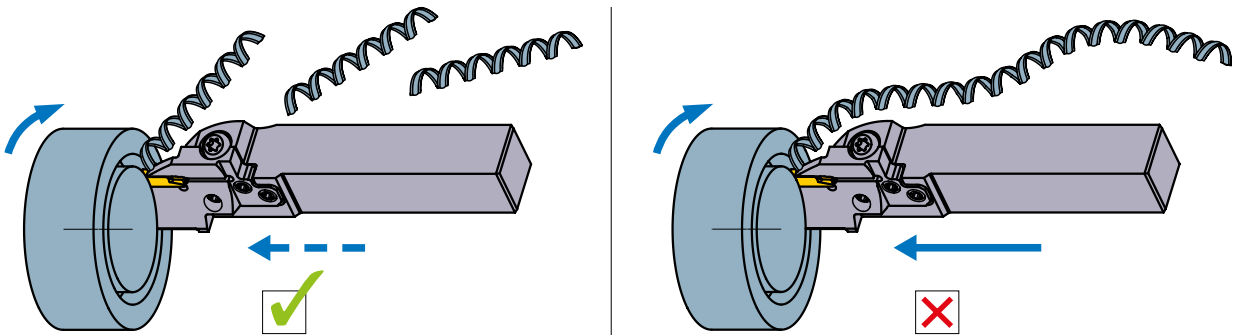

- When chips become too long, use peck feed to break them into a suitable length.

Notes when wide face grooving by plunging in several passes

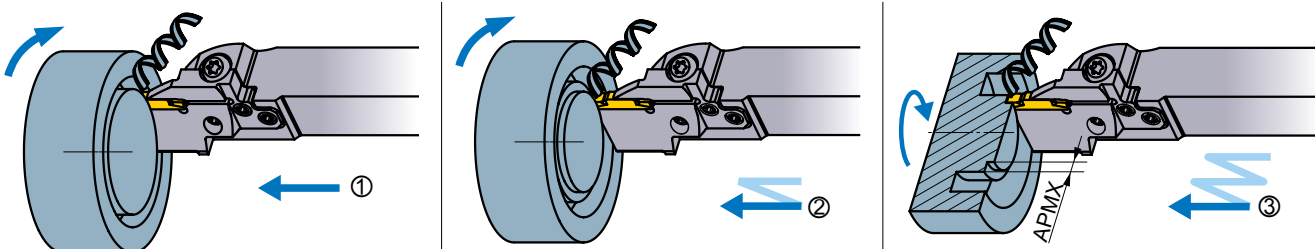

- When machining a face groove in several passes, machine from the outer diameter towards the centre so that space for discharging chips is created to prevent insert damage caused by chip jamming.
- Plunging width of cut is recommended to be set at 60 - 80% of the insert width. This enhances the effect of the chipbreaker by enlarging the width of the groove to improve chip dispersal.

Notes when wide face grooving by combination of plunging and traverse machining (1)

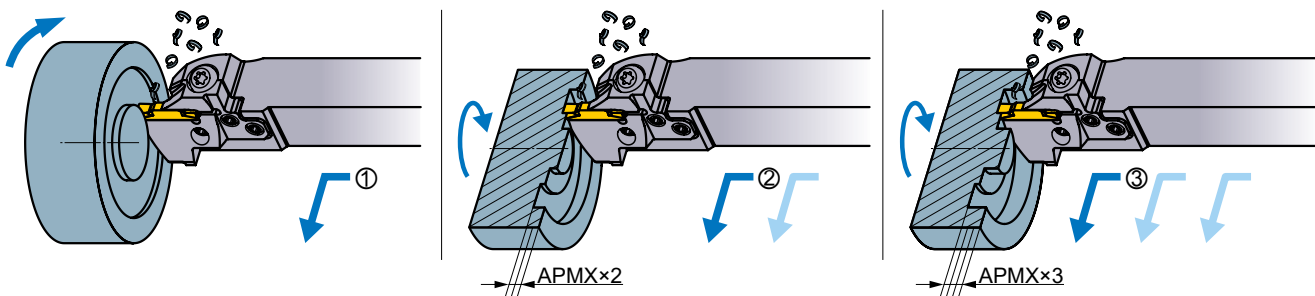

- When face groove machining by using plunge feed and traverse machining, always machine from the outer diameter towards the centre to disperse chips outward to avoid chip jamming problems.
- Set the depth of cut within 40% of the insert width.

Notes when wide face grooving by combination of plunging and traverse machining (2)

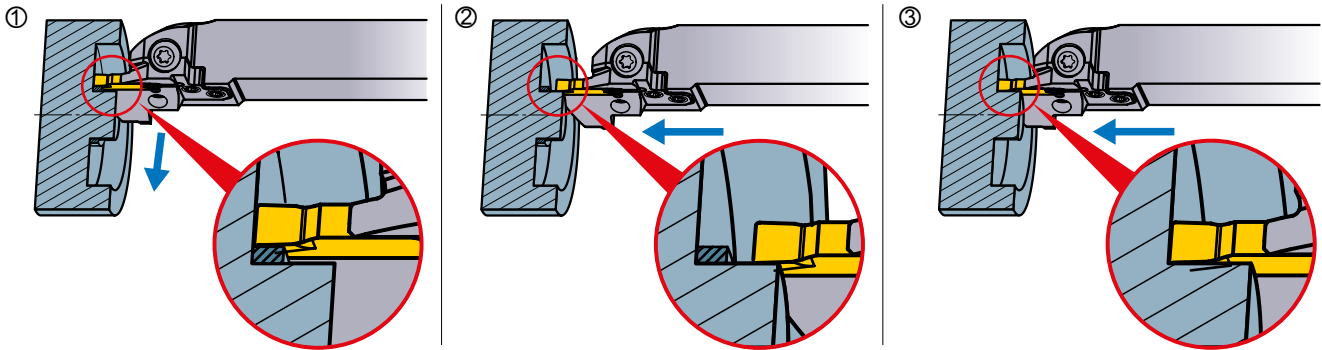

- When infeed machining at the bottom of a deep groove, chips may interfere on the cutting edge near the centre wall. In such cases, stop infeed machining just before the centre wall (at a point less than the insert width) then remove the remaining material by plunging.

Notes when copying (BM Breaker)

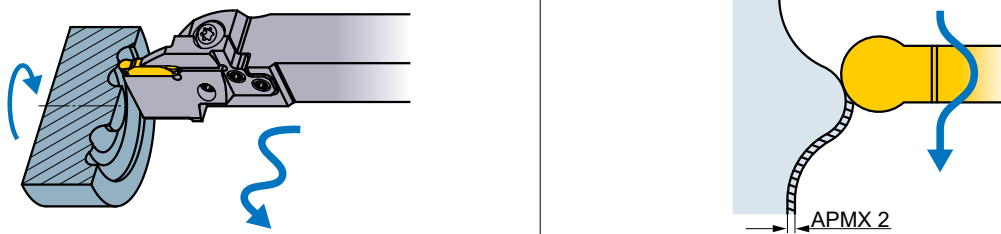

- With the BM breaker insert, 3 dimensional copying is possible. Set the depth of cut (APMX 2) to 30% less than the insert width.

Finishing (1)

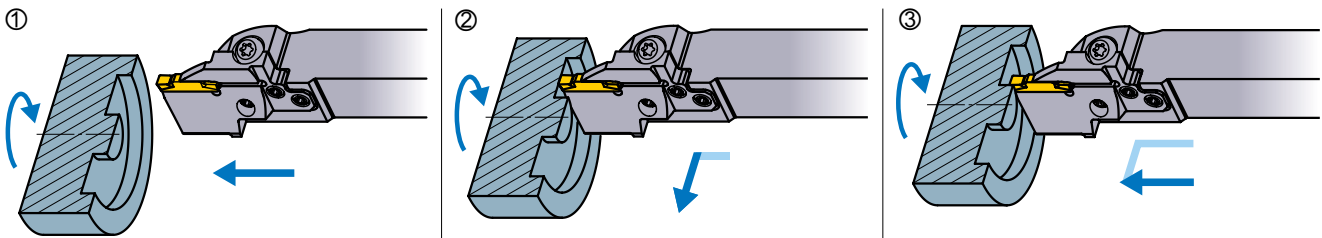

- When finish cutting, machine continuously from the outer wall to the bottom of the groove, then finally plunge cut the centre wall.

Finishing (2) (BM Breaker)

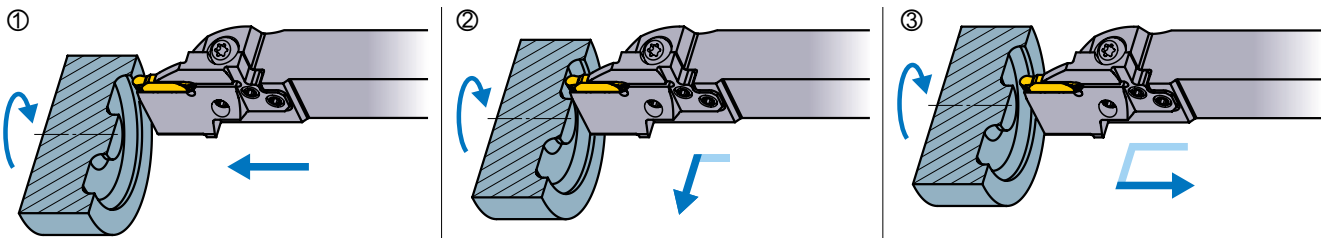

- Carry out finishing in one process. For the depth of cut (APMX 2) when back turning, refer to the table on the right.

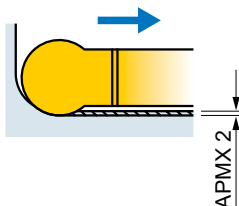

Insert	APMX 2 (mm)
GY2M0200D100N-BM	0.10
GY2M0250E125N-BM	
GY2M0300F150N-BM	
GY2M0318F159N-BM	0.15
GY2M0400G200N-BM	
GY2M0475H238N-BM	0.20
GY2M0500H250N-BM	
GY2M0600J300N-BM	0.25
GY2M0635J318N-BM	

GROOVING / CUTTING OFF

RECOMMENDED CUTTING SPEED [For Internal Grooving]

Work Material	Hardness	Grade	Cutting Speed (m/min)						
			50	100	150	200	250	300	400
P Mild Steel	≤160HB	VP20RT	80 — 180						
		VP10RT	90 — 190						
		NX2525	70 — 170						
	Carbon Steel Alloy Steel	160–280HB	VP20RT	60 — 140					
			VP10RT	70 — 150					
			MY5015	90 — 210					
		280HB≤	VP20RT	50 — 110					
			VP10RT	60 — 120					
M Stainless Steel	≤270HB	VP20RT	50 — 110						
		VP10RT	60 — 120						
	K Gray Cast Iron	Tensile Strength ≤300MPa	VP20RT	60 — 140					
			VP10RT	70 — 150					
			MY5015	90 — 210					
	Ductile Cast Iron	Tensile Strength ≤800MPa	VP20RT	50 — 110					
			VP10RT	60 — 120					
			MY5015	80 — 160					
S Heat Resistant Alloy Titanium Alloy	—	MP9015	40 — 100						
		MP9025	30 — 90						
		VP20RT	30 — 60						
		VP10RT/RT9010	40 — 70						
H Hardened steel	50HRC≤	BC8110	60 — 100						
N Aluminium Alloy	Content Si<5%	RT9010	150 — 400						
	Content 5%≤Si≤10%	RT9010	150 — 400						
	Content Si>10%	RT9010	80 — 160						

Note 1) VP20RT is the first recommended grade for materials other than hardened steels.

Note 2) For RT9010, VP10RT, VP20RT and MY5015, wet cutting is recommended.

RECOMMENDED CUTTING CONDITIONS [For Internal Grooving]

GROOVING

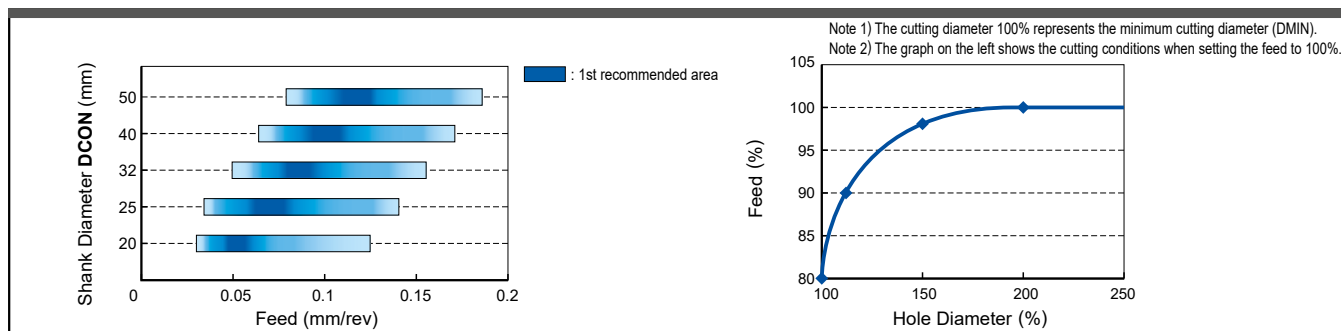

GROOVING (GL BREAKER)

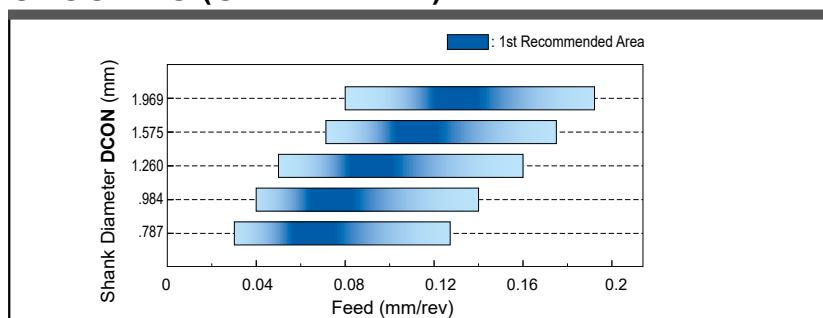

TRAVERSE MACHINING (MF BREAKER)

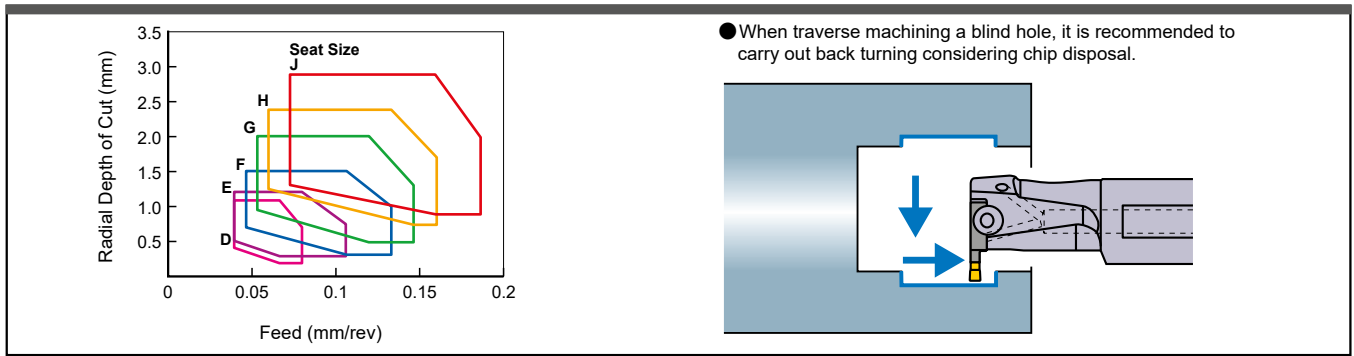

TRAVERSE MACHINING (MM/MS BREAKER)

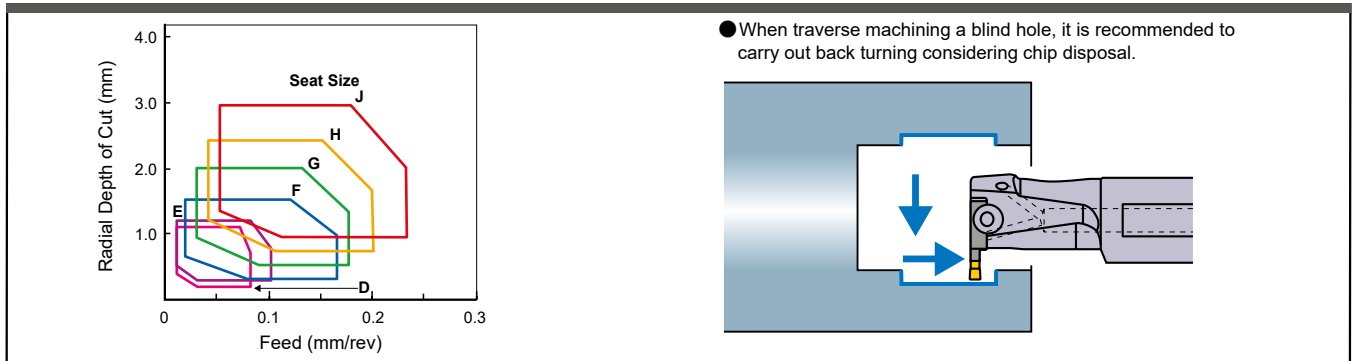

Note 1) The above cutting conditions are for when using the tool overhang (LU) 1.6-2.0 times larger than the shank diameter (DCON). (L/D=1.6-2.0)
When using L/D larger than 2.0, reduce the cutting conditions.

Seat Size			
	Insert Width (mm)		
D	2.00	G	4.00
	2.24		4.24
E	2.39	H	4.75
	2.50		5.00
F	2.74		5.24
	3.00	J	6.00
G	3.18		6.31
	3.24		6.35

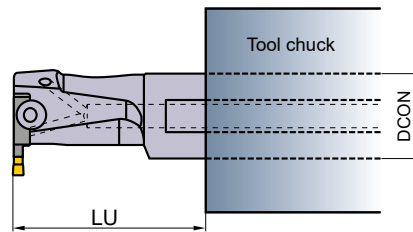

LIMITATION OF THE MAXIMUM GROOVE DEPTH [For Internal Grooving]

- When using the monoblock type
The maximum groove depth is not limited by the cutting diameter.
- When using the modular blade type
The maximum groove depth is limited by the cutting diameter.

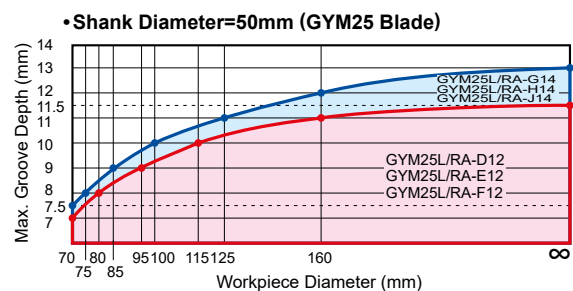
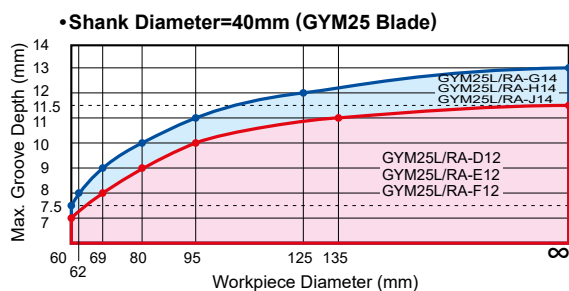
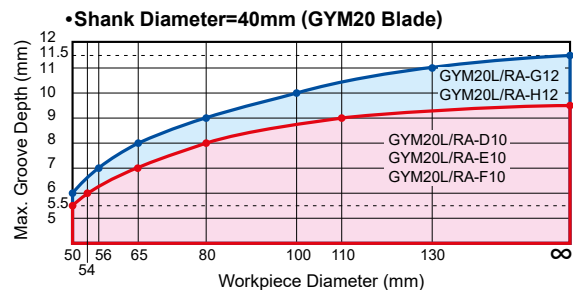
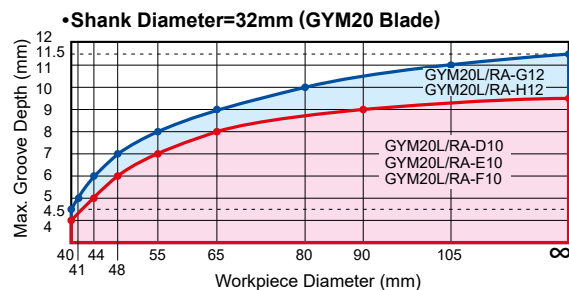
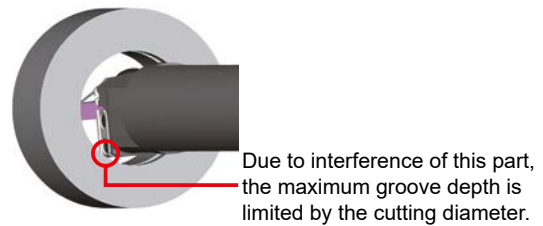

TOOL SELECTION

Notes when selecting the tool body

Holder

● When the overhang is the same, select a holder with the largest possible shank size to ensure sufficient clamping rigidity.

Modular blade (1)

GYM20R/LA-○○○○

GYM20R/LA-D10
GYM20R/LA-E10
GYM20R/LA-F10
GYM20R/LA-G12
GYM20R/LA-H12

GYM25R/LA-○○○○

GYM25R/LA-D12
GYM25R/LA-E12
GYM25R/LA-F12
GYM25R/LA-G14
GYM25R/LA-H14
GYM25R/LA-J14

● For an internal holder, select a modular blade listed above.

Modular blade (2)

● For a $\varnothing 40$ shank holder, if there is no restriction for use, select a holder suitable for GYM25 blade.

Notes when setting the tool

Overhang

● The maximum groove depth is limited to the dimension LDRED. When machining with longer overhangs, refer to the dimension WF2 of the tool used.

MACHINING RECOMMENDATIONS

Notes on multi-function machining (MF, MS and MM breakers)

For internal grooving, the machining methods for external grooving can be used, but please note the following precautions.

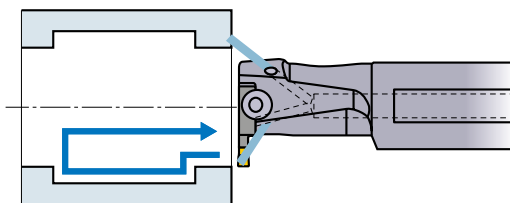
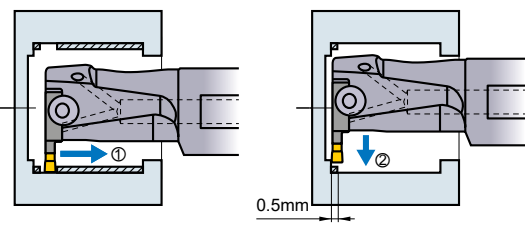
Coolant	Machining blind holes
 <ul style="list-style-type: none"> ● Supply large amounts of coolant for effective chip disposal during cutting. Maintain supply until the tool has been retracted completely for improved chip disposal. 	 <ul style="list-style-type: none"> ● As continuous chips tend to elongate at the back of the bore, the above operation is recommended. The recommended width of cut for \varnothing is 0.5 mm.

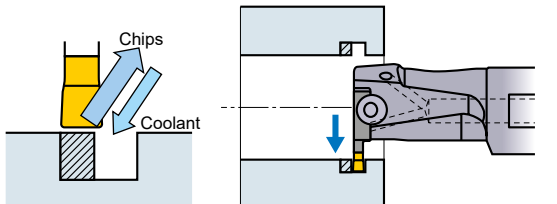
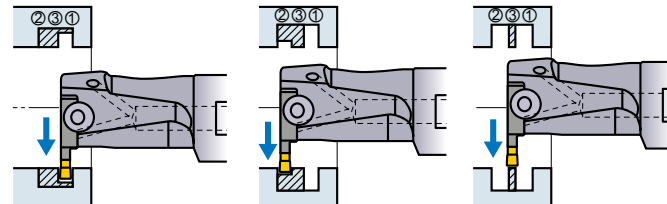
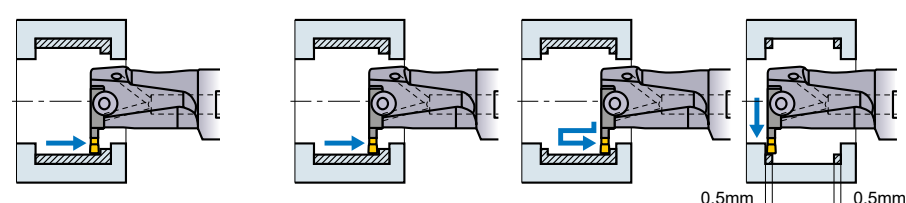
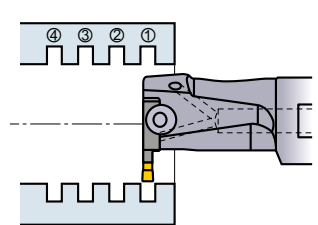
Machining Wide Grooves	
<p style="text-align: center;">Grooving</p> <ul style="list-style-type: none"> ● When the cutting edge width is $x 2 \geq$ groove width  <ul style="list-style-type: none"> ● When the depth of cut is shallower than the cutting edge width, continuous chips are usually produced. When plunging in several passes, it is recommended to carry out machining in the steps above. This ensures that coolant reaches the cutting edge and chips are easily discharged. 	<ul style="list-style-type: none"> ● When the cutting edge width is $x 2 <$ groove width  <ul style="list-style-type: none"> ● When the groove depth is larger than the cutting edge width, carry out plunging in the steps above to break up chips efficiently.
<p style="text-align: center;">Turning</p>  <ul style="list-style-type: none"> ● When chip breaking and disposal are especially important, cross-feed machining is recommended. ● Wide face grooving when the corner R of the work piece is equal to the corner R of the insert, machine as shown above. (When corner R of the work piece is larger than corner R of the insert, refer to the description of external wide grooving.) ● If the groove depth exceeds a given level, chips may elongate at the wall. In such a case, increase the feed and carry out machining as shown above. 	<p style="text-align: center;">Machining instruction</p>  <ul style="list-style-type: none"> ● It is recommended to carry out grooving from the front end of the workpiece. This reduces workpiece deflection.

F
GROOVING / CUTTING OFF

GW SERIES

Easy to Utilise Configuration that Improves Tool Handling

Clamping method

Simple insert clamping method offering high rigidity

To prevent extraction during machining, the insert features a reverse taper angle. Additionally the design also includes 3 large locating faces with the blade offering increased cutting edge reliability.

The blade itself is made from a suitable, special alloy steel. For changing the insert, a unique wrench is supplied to ensure ease of use.



Reverse Taper Angle

Voice of the Developer

Easy insert setting

By using the unique wrench, it is possible to remove the insert with one simple action making it easier for everyday use in the workshop.



Through Coolant Blade

Increased wear resistance due to 2 through coolant holes

2 through holes supply coolant to both the rake and flank face, leading to effective cutting edge cooling and increased wear resistance.

Additionally the blade can also be utilised with both low and high pressure coolant (7MPa).

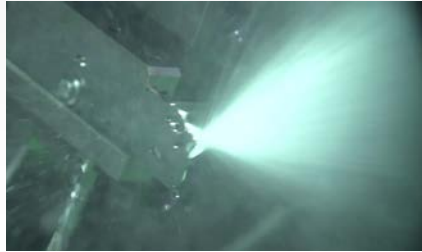

Voice of the Developer

Reduced heat generation

The 2 coolant holes used in the blade are capable of coping with pressures up to 7MPa. This is achieved by using as large as possible hole diameter. The coolant holes are located close to the cutting edge to improve cutting edge cooling effect and increasing wear resistance.

Coolant Ports

Flexibility with the use of 6 coolant ports

There are 6 coolant ports designed into the tool block, making it easy to set up the block and blade to a suitable configuration. The through coolant holes improve cutting edge cooling and chip evacuation.

The use of external coolant hoses is also possible.

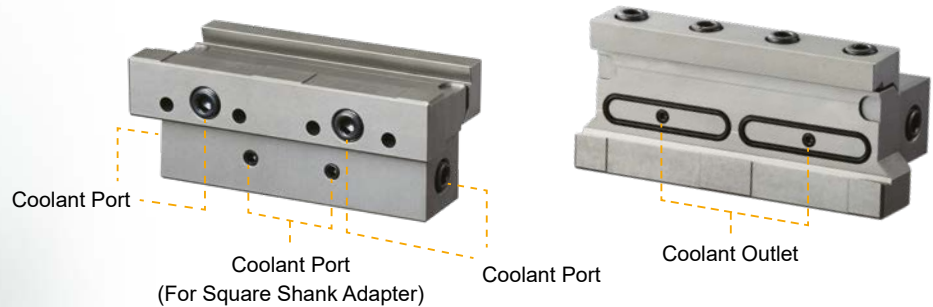

Voice of the Developer

Possible to set up to suit the requirements of the workshop environment.

One of the objectives of this product is to respond to the customers complaints that "the product did not fit and could not be used". Starting with the coolant outlet that prevents leaks even when oil quantity or overhangs change, everything from the material and the shape of the O-ring, to the length of the hose has been tailored to the effective use in the workshop.

Breaker System Offering Excellent Chip Disposal Properties

Low Feeds



Medium Feeds



INSERT GRADE

Work Material / Machining Condition	P Steel	M Stainless Steel	K Cast Iron	S Heat Resistant Alloy / Titanium Alloy
Stable Machining Condition Unstable	MY5015 VP10RT	VP10RT	MY5015 VP10RT	VP10RT
	VP20RT VP30RT	VP20RT VP30RT	VP20RT VP20RT	VP20RT

GROOVING / CUTTING OFF

VP20RT (1st Recommendation)

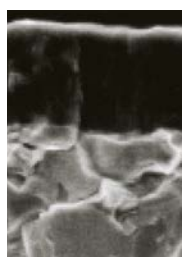

- PVD coated grade suitable for a wide range of applications. The combination of a special tough cemented carbide substrate with MIRACLE coating provides an excellent balance of wear and fracture resistance.

MIRACLE Coating
Carbide Substrate (90.5HRA)

MY5015

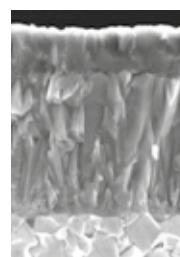

- CVD coated grade with excellent wear resistance even at high temperatures. Providing longer tool life when machining cast and ductile cast irons. Also suitable for high speed continuous cutting of steels.

CVD Coated Carbide
Carbide Substrate

VP10RT

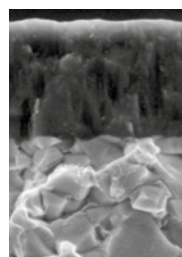

- PVD coated grade with a cemented carbide substrate harder than VP20RT. For use on difficult-to-cut materials and for extending tool life.

MIRACLE Coating
Carbide Substrate (92.0HRA)

VP30RT

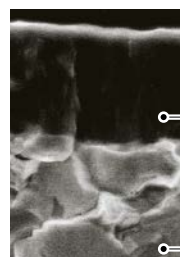

- A combination of a tough, special cemented carbide substrate and MIRACLE coating. Ideal for heavy interrupted cutting of stainless and general steels.

MIRACLE Coating (Al,Ti)N
Carbide Substrate (88.8HRA)

GW SERIES ORDER NUMBER

■ Insert / Blade / Tool Block

● Insert

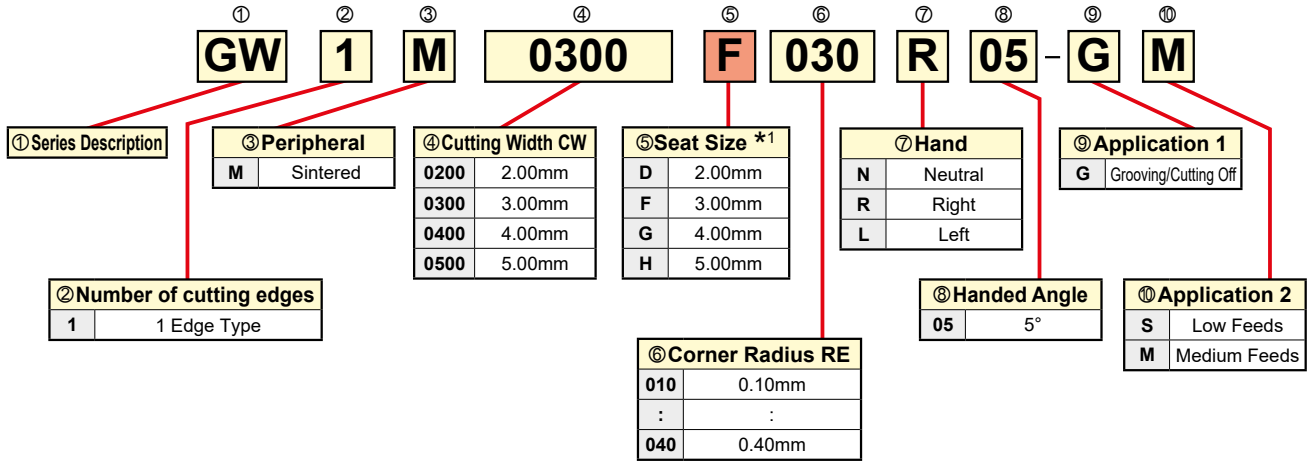

● Blade

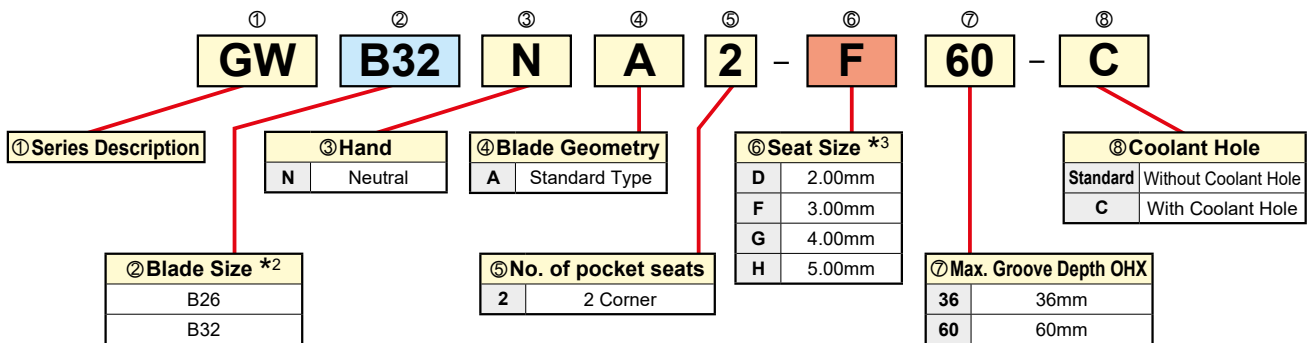

● Tool Block

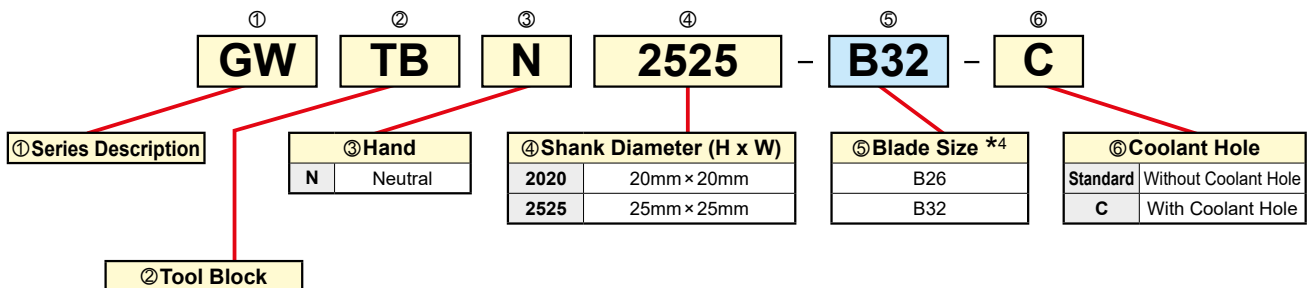

- *1 Select seat size with the same symbol as the blade.
- *2 Select blade size with the same symbol as the tool block.
- *3 Select seat size with the same symbol as the insert.
- *4 Select blade size with the same symbol as the blade.

GROOVING / CUTTING OFF

GW BLADE

- Simple insert clamping method offering high rigidity.
- Possible to use with both external or through coolant.
- Groove Depth CW 2.0—5.0 mm

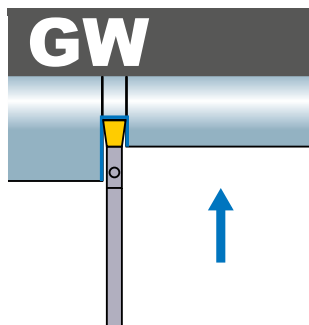

For External Cutting Off / Grooving

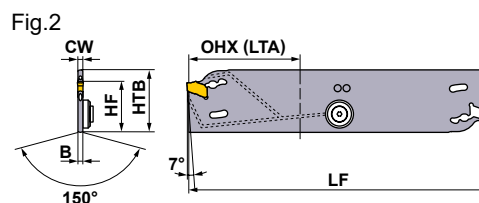
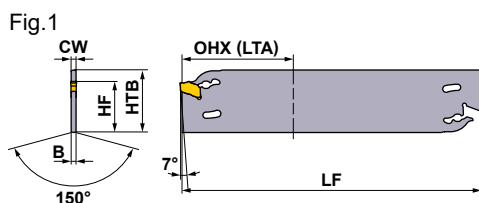

Without Coolant Hole

(mm)

Seat Size	CW	*1 CUTDIA	Order Number	Stock	*2 OHN	*3 OHX (LTA)	B	LF	HTB	HF	Fig.	Insert Type		Wrench	Tool Block Type
												Insert Type	Wrench		
D	2.00	72	GWB26NA2-D36	●	16	36	1.55	110	26	21.4	1	GW1M0200D	GWY39L	GWTBN-B26	
		120	GWB32NA2-D60	●	16	60	1.55	150	32	25	1	GW1M0200D	GWY39L	GWTBN-B32	
F	3.00	72	GWB26NA2-F36	●	16	36	2.45	110	26	21.4	1	GW1M0300F	GWY39L	GWTBN-B26	
		120	GWB32NA2-F60	●	16	60	2.45	150	32	25	1	GW1M0300F	GWY39L	GWTBN-B32	
G	4.00	72	GWB26NA2-G36	●	19	36	3.35	110	26	21.4	1	GW1M0400G	GWY39L	GWTBN-B26	
		120	GWB32NA2-G60	●	19	60	3.35	150	32	25	1	GW1M0400G	GWY39L	GWTBN-B32	
H	5.00	72	GWB26NA2-H36	●	19	36	4.25	110	26	21.4	1	GW1M0500H	GWY39L	GWTBN-B26	
		120	GWB32NA2-H60	●	19	60	4.25	150	32	25	1	GW1M0500H	GWY39L	GWTBN-B32	

With Coolant Hole

(mm)

Seat Size	CW	*1 CUTDIA	Order Number	Stock	*2 OHN	*3 OHX (LTA)	B	LF	HTB	HF	Fig.	Insert Type		Wrench	Tool Block Type
												Insert Type	Wrench		
D	2.00	72	GWB26NA2-D36-C	●	16	36	1.55	110	26	21.4	2	GW1M0200D	GWY39L	GWTBN-B26-C	
		120	GWB32NA2-D60-C	●	26	60	1.55	150	32	25	2	GW1M0200D	GWY39L	GWTBN-B32-C	
F	3.00	72	GWB26NA2-F36-C	●	16	36	2.45	110	26	21.4	2	GW1M0300F	GWY39L	GWTBN-B26-C	
		120	GWB32NA2-F60-C	●	26	60	2.45	150	32	25	2	GW1M0300F	GWY39L	GWTBN-B32-C	
G	4.00	72	GWB26NA2-G36-C	●	19	36	3.35	110	26	21.4	2	GW1M0400G	GWY39L	GWTBN-B26-C	
		120	GWB32NA2-G60-C	●	26	60	3.35	150	32	25	2	GW1M0400G	GWY39L	GWTBN-B32-C	
H	5.00	72	GWB26NA2-H36-C	●	19	36	4.25	110	26	21.4	2	GW1M0500H	GWY39L	GWTBN-B26-C	
		120	GWB32NA2-H60-C	●	26	60	4.25	150	32	25	2	GW1M0500H	GWY39L	GWTBN-B32-C	

*1 CUTDIA: Maximum Cut Off Diameter *2 OHN: Minimum Overhang Length *3 OHX(LTA): Maximum Overhang Length
 Note 1) Recommended Maximum Coolant Pressure : 7MPa

Spare Parts for Blades with Coolant Hole

(mm)

Order Number	CW	Washer		Clamp Screw	Wrench
		①	②		
GWB26NA2-D36-C	2.0	①GWW04038		GW04005F	HKY20R
GWB32NA2-D60-C	2.0	①GWW04038		GW04005F	HKY20R
GWB26NA2-F36-C	3.0	①GWW04038		GW04005F	HKY20R
GWB32NA2-F60-C	3.0	①GWW04038		GW04005F	HKY20R
GWB26NA2-G36-C	4.0	②GWW04026		GW04005F	HKY20R
GWB32NA2-G60-C	4.0	②GWW04026		GW04005F	HKY20R
GWB26NA2-H36-C	5.0	②GWW04026		GW04005F	HKY20R
GWB32NA2-H60-C	5.0	②GWW04026		GW04005F	HKY20R

● : Inventory maintained. ★ : Inventory maintained in Japan.

■ Tool Block

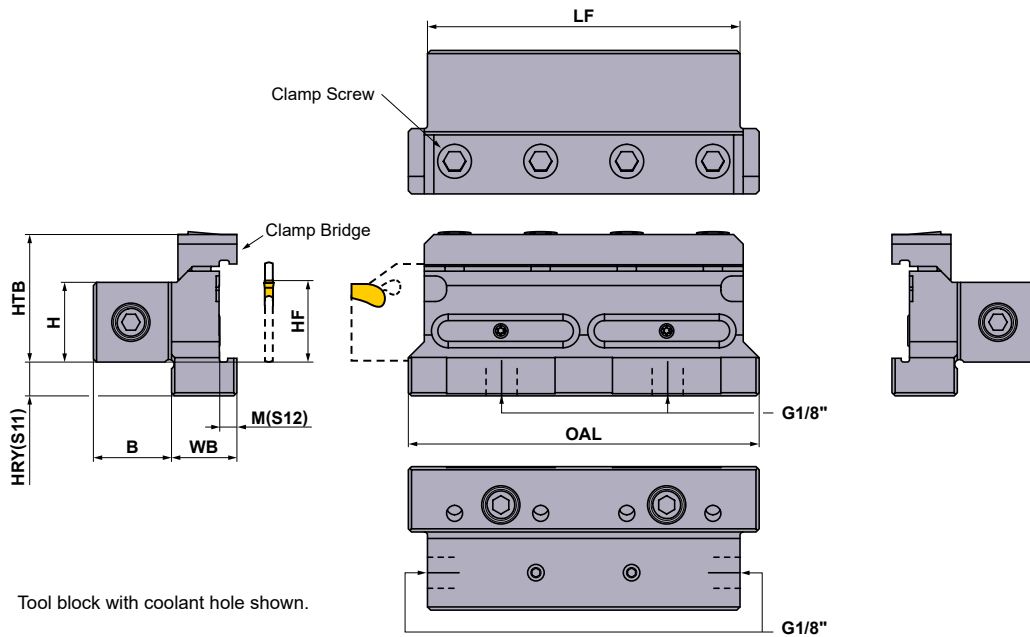

Tool block with coolant hole shown.

Without Coolant Hole

Order Number	Stock	H	HF	HTB	HRY (S11)	B	WB	M (S12)	LF	OAL	(mm)		
											① Clamp Bridge	② Clamp Screw *	③ Wrench
GWTBN2020-B26	★	20	20	33.5	11	19.5	20.0	5.0	75	85	① GWCW1	HSC06020	HKY50R
GWTBN2020-B32	★	20	20	35.0	15.6	19.5	20.5	5.5	100	110	② GWCW2	HSC06020	HKY50R
GWTBN2525-B26	★	25	25	38.5	6	24.5	20.0	5.0	75	85	① GWCW1	HSC06020	HKY50R
GWTBN2525-B32	★	25	25	40.0	10.6	24.5	20.5	5.5	100	110	② GWCW2	HSC06020	HKY50R

With Coolant Hole

Order Number	Stock	H	HF	HTB	HRY (S11)	B	WB	M (S12)	LF	OAL	(mm)		
											① Clamp Bridge	② Clamp Screw *	③ Wrench
GWTBN2020-B26-C	●	20	20	33.5	11	19.5	20.0	5.0	75	85	① GWCW1	HSC06020	HKY50R
GWTBN2020-B32-C	●	20	20	35.0	15.6	19.5	20.5	5.5	100	110	② GWCW2	HSC06020	HKY50R
GWTBN2525-B26-C	●	25	25	38.5	6	24.5	20.0	5.0	75	85	① GWCW1	HSC06020	HKY50R
GWTBN2525-B32-C	●	25	25	40.0	10.6	24.5	20.5	5.5	100	110	② GWCW2	HSC06020	HKY50R

* Clamp Torque (N · m) : HSC06020=7.0

Note 1) Recommended Maximum Coolant Pressure : 7MPa

Spare Parts for Tool Block with Coolant Hole

Order Number	① O-ring	② Plug	③ Plug	④ Wrench	⑤ Plug	⑥ Wrench
GWTBN2020-B26-C	ORGW332N9	HGJ-PT1/8	HSD05004S	HKY25R	CS300590T	TKY08R
GWTBN2020-B32-C	ORGW457N9	HGJ-PT1/8	HSD05004S	HKY25R	CS300590T	TKY08R
GWTBN2525-B26-C	ORGW332N9	HGJ-PT1/8	HSD05004S	HKY25R	CS300590T	TKY08R
GWTBN2525-B32-C	ORGW457N9	HGJ-PT1/8	HSD05004S	HKY25R	CS300590T	TKY08R

GROOVING / CUTTING OFF

Inserts

(mm)

Application	Order Number	Stock						CW		REL	RER	PSIRR PSIRL	Geometry
		Coating				Carbide		Cutting Width	Tolerance				
		MY5015	VP10RT	VP20RT	VP30RT	RT9010	RT9020						
Grooving, Cutting Off	GW1M0200D020N-GS	●	●	●				2.00	±0.03	0.2	0.2	—	
Grooving, Cutting Off	GW1M0300F020N-GS	●	●	●				3.00	±0.03	0.2	0.2	—	
Grooving, Cutting Off	GW1M0400G020N-GS	●	●	●				4.00	±0.04	0.2	0.2	—	
Grooving, Cutting Off	GW1M0500H030N-GS	●	●	●				5.00	±0.04	0.3	0.3	—	
Grooving, Cutting Off	GW1M0200D020N-GM	●	●	●				2.00	±0.03	0.2	0.2	—	
Grooving, Cutting Off	GW1M0300F030N-GM	●	●	●				3.00	±0.03	0.3	0.3	—	
Grooving, Cutting Off	GW1M0400G030N-GM	●	●	●				4.00	±0.04	0.3	0.3	—	
Grooving, Cutting Off	GW1M0500H040N-GM	●	●	●				5.00	±0.04	0.4	0.4	—	
Cutting off, Low Feed	NEW GW1M0200D020R05-GS	★	★	★				2.00	±0.03	0.2	0.2	5	
Cutting off, Low Feed	NEW GW1M0300F020R05-GS	★	★	★				3.00	±0.03	0.2	0.2	5	
Cutting off Low Feed, Lead Angle 8°	NEW GW1M0200D003R08-GS	★	★	★				2.00	±0.03	0.03	0.03	8	
Cutting off Low Feed, Lead Angle 8°	NEW GW1M0300F003R08-GS	★	★	★				3.00	±0.03	0.03	0.03	8	
Cutting Off	GW1M0200D020R05-GM	●	●	●				2.00	±0.03	0.2	0.2	5	 Right hand insert shown.
Cutting Off	GW1M0200D020L05-GM	●	●	●				2.00	±0.03	0.2	0.2	5	
Cutting Off	GW1M0300F030R05-GM	●	●	●				3.00	±0.03	0.3	0.3	5	
Cutting Off	GW1M0300F030L05-GM	●	●	●				3.00	±0.03	0.3	0.3	5	
Cutting Off	GW1M0400G030R05-GM	●	●	●				4.00	±0.04	0.3	0.3	5	
Cutting Off	GW1M0400G030L05-GM	●	●	●				4.00	±0.04	0.3	0.3	5	
Cutting Off	GW1M0500H040R05-GM	●	●	●				5.00	±0.04	0.4	0.4	5	
Cutting Off	GW1M0500H040L05-GM	●	●	●				5.00	±0.04	0.4	0.4	5	
Blank	NEW GW1B0320D020N					★	★	3.24	±0.10	0.2	0.2	—	
Blank	NEW GW1B0440F020N					★	★	4.44	±0.10	0.2	0.2	—	
Blank	NEW GW1B0540G020N					★	★	5.44	±0.10	0.2	0.2	—	
Blank	NEW GW1B0640H020N					★	★	6.44	±0.10	0.2	0.2	—	

Note 1) Blank inserts to be ground by customers.

Proper Use of GW Series Right Hand Inserts

First Recommendation

Improved Fracture Resistance

Reduction of Burrs and Core Residue

GM Breaker

PSIRR=5°
RE=0.20

GS Breaker

PSIRR=5°
RE=0.20

GS Breaker

PSIRR=8°
RE=0.03

Reduction of Cutting Resistance





Improved Fracture Resistance



● : Inventory maintained. ★ : Inventory maintained in Japan.
(10 inserts in one case)

Coolant Hose Kit

(mm)

Connector Type	Order Number	Stock	Hose Length	Kit Details								
												
				Code No.	Code No.	QTY.	Code No.	QTY.	Code No.	QTY.	Code No.	QTY.
Straight	CS-1/8-150SS	●	150	HOSE-1/8-150	—	—	—	—	AD-G1/8	2	WA-M10	2
Straight	CS-1/8-200SS	●	200	HOSE-1/8-200	—	—	—	—	AD-G1/8	2	WA-M10	2
Straight	CS-1/8-250SS	●	250	HOSE-1/8-250	—	—	—	—	AD-G1/8	2	WA-M10	2
Straight	CS-1/8-300SS	●	300	HOSE-1/8-300	—	—	—	—	AD-G1/8	2	WA-M10	2
Elbow Straight	CS-1/8-150BS	●	150	HOSE-1/8-150	AD-BM10	1	BB-G1/8	1	AD-G1/8	1	WA-M10	3
Elbow Straight	CS-1/8-200BS	●	200	HOSE-1/8-200	AD-BM10	1	BB-G1/8	1	AD-G1/8	1	WA-M10	3
Elbow Straight	CS-1/8-250BS	●	250	HOSE-1/8-250	AD-BM10	1	BB-G1/8	1	AD-G1/8	1	WA-M10	3
Elbow Straight	CS-1/8-300BS	●	300	HOSE-1/8-300	AD-BM10	1	BB-G1/8	1	AD-G1/8	1	WA-M10	3
Elbow	CS-1/8-150BB	●	150	HOSE-1/8-150	AD-BM10	2	BB-G1/8	2	—	—	WA-M10	4
Elbow	CS-1/8-200BB	●	200	HOSE-1/8-200	AD-BM10	2	BB-G1/8	2	—	—	WA-M10	4
Elbow	CS-1/8-250BB	●	250	HOSE-1/8-250	AD-BM10	2	BB-G1/8	2	—	—	WA-M10	4
Elbow	CS-1/8-300BB	●	300	HOSE-1/8-300	AD-BM10	2	BB-G1/8	2	—	—	WA-M10	4

Connection Screw Size = G1/8"

Mounting Example

Elbow Straight Type

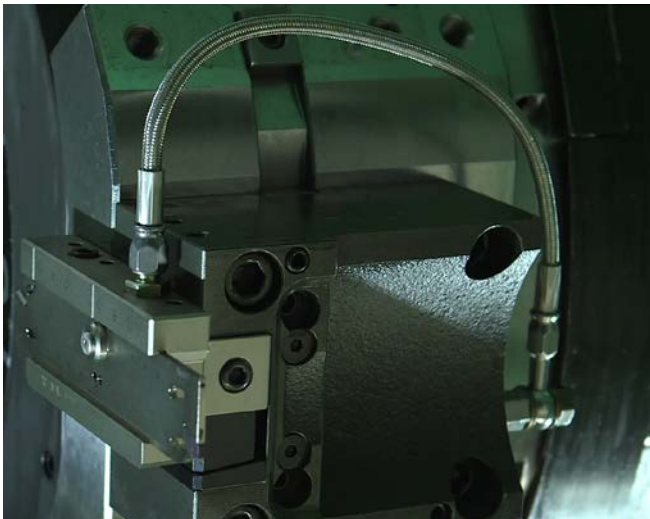

Elbow Type

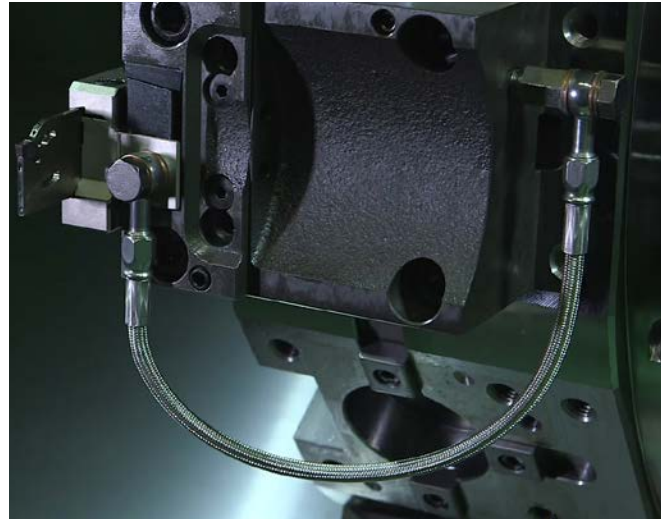

F

GROOVING / CUTTING OFF

RECOMMENDED CUTTING CONDITIONS

■ Cutting Speed

Work Material	Hardness	Grade	Cutting Speed (m/min)					
			50	100	150	200	250	300
P Mild Steel Carbon Steel Alloy Steel	≤160HB	VP20RT		100		240		
		VP10RT		110		250		
	160–280HB	VP20RT	80		200			
		VP10RT	90		210			
		VP30RT	60		180			
		MY5015		110		250		
	≥280HB	VP20RT	60		160			
		VP10RT	70		170			
		VP30RT	40		140			
		MY5015		90		210		
M Stainless Steel	≤270HB	VP20RT	60		180			
		VP10RT	70		190			
		VP30RT	40		160			
K Gray Cast Iron Ductile Cast Iron	Tensile Strength ≤300MPa	VP20RT		80		200		
		VP10RT		90		210		
		MY5015			140		300	
	Tensile Strength ≤800MPa	VP20RT	60		160			
		VP10RT	70		170			
		MY5015		90		210		
S Heat Resistant Alloy Titanium Alloy	—	VP20RT	30	60				
		VP10RT	40	70				

Note 1) VP20RT is the first recommended grade for general materials.

Note 2) For VP10RT, VP20RT, VP30RT and MY5015, wet cutting is recommended.

■ Feed per Revolution

GM Breaker

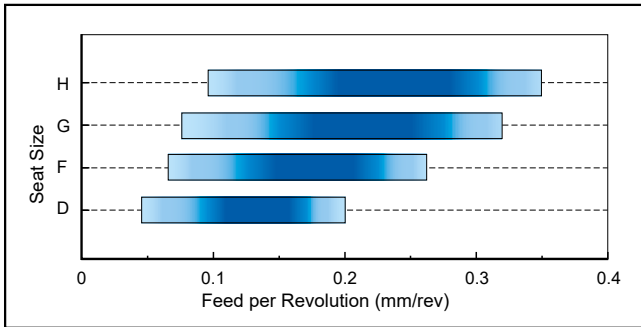

GS Breaker

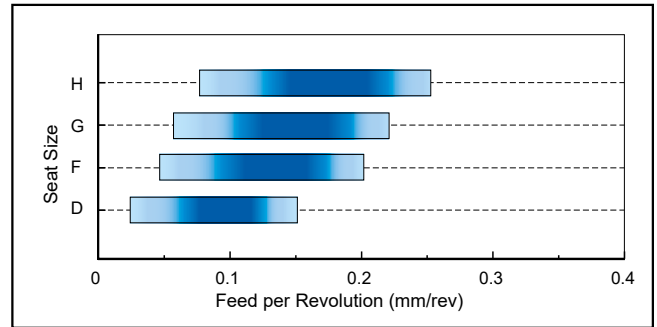

Chipbreaker	Feed per Revolution (mm/rev)			
	Seat Size D	Seat Size F	Seat Size G	Seat Size H
GM Breaker	0.05–0.20	0.07–0.26	0.08–0.32	0.10–0.35
GS Breaker	0.03–0.15	0.05–0.20	0.06–0.22	0.08–0.25

■ Cutting Off Feed per Revolution

R05-GS Breaker

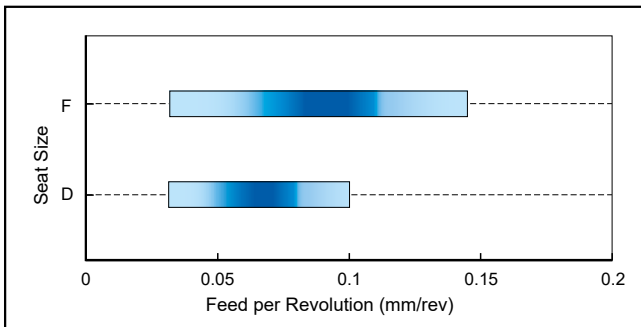

R08-GS Breaker

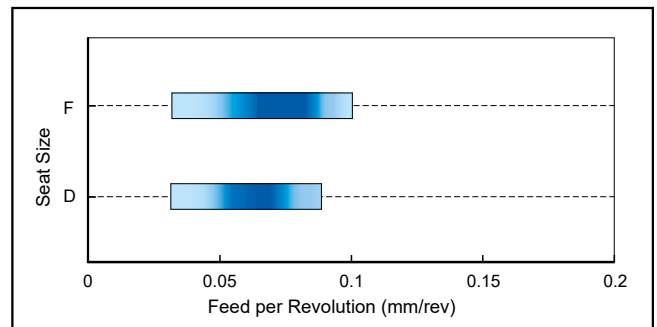

R/L05-GM Breaker

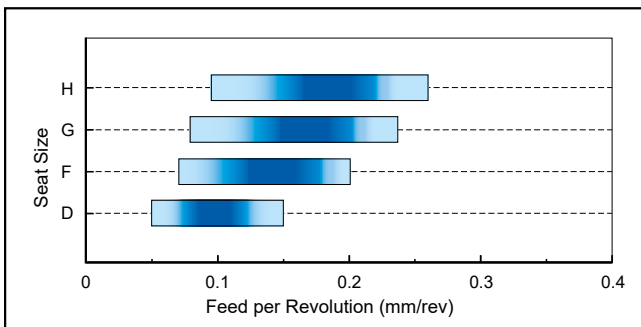

Chipbreaker	PSIPR	Hand	Feed per Revolution (mm/rev)			
			Seat Size D	Seat Size F	Seat Size G	Seat Size H
R05-GS	5°	R	0.03–0.10	0.03–0.14	–	–
R08-GS	8°	R	0.03–0.08	0.03–0.14	–	–
R05-GM	5°	R/L	0.05–0.15	0.07–0.20	0.08–0.23	0.10–0.26

F

GROOVING / CUTTING OFF

GROOVING / CUTTING OFF

MG HOLDER

- Clamp-on type
- Positive insert suffers from negligible chattering and thus produces a good finished surface.
- Cutting width CW 1.25–6.0mm

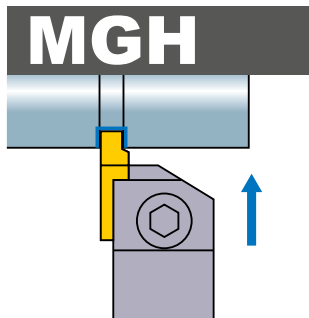

External grooving

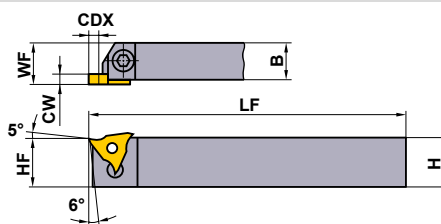

Right hand tool holder shown.

Order Number	Stock		Insert Number	Dimensions(mm)												
	R	L		CW	CDX	H	B	LF	HF	WF						
MGHR/L2020K3315	●	●	MGTR/L 33125 33400	1.25	1.2	20	20	125	20	20.2						
MGHR/L2020K3323	●	●		1.45	1.5											
				1.5 ≤ CW ≤ 2.3	3.0											
MGHR/L2525M3315	●	●	MGTR/L 43125 43470	2.3 < CW ≤ 3.3	3.0	20	20	125	20	20.2						
MGHR/L2525M3315	●	●		1.25	1.2						25	25	150	25	25.2	
MGHR/L2525M3323	●	●		1.45	1.5											
				1.5 ≤ CW ≤ 2.3	3.0											
MGHR/L2525M3333	★	●			2.3 < CW ≤ 3.3						3.0	25	25	150	25	25.2
				3.3 < CW ≤ 4.7	3.0	25	25	150	25	25.2						
MGHR/L2020K4315	●	●	MGTR/L 44500 44600	1.25	1.2 (2.0)*	20	20	125	20	20.2						
MGHR/L2020K4323	●	●		1.45	1.5											
				1.5 ≤ CW ≤ 2.3	3.0 (3.5)*											
MGHR/L2020K4333	●	●		2.3 < CW ≤ 3.3	4.5 (4.0)*						20	20	125	20	20.2	
				3.3 < CW ≤ 4.7 (4.0)*	4.5 (5.0)*											
MGHR/L2525M4315	●	●			1.25						1.2 (2.0)*	25	25	150	25	25.2
					1.45						1.5					
					1.5 ≤ CW ≤ 2.3						3.0 (3.5)*					
MGHR/L2525M4323	●	●			2.3 < CW ≤ 3.3						4.5 (4.0)*					
MGHR/L2525M4333	★	●		3.3 < CW ≤ 4.7 (4.0)*	4.5 (5.0)*											
MGHR/L2525M4447	●	●		4.7 < CW ≤ 6.3	4.5	25	25	150	25	25.2						

* Dimensions when installing the CBN insert.

SPARE PARTS

Order Number		*		
MGHR/L2020K3315 MGHR/L2525M4447	Clamp Bridge MTK1R/L	Clamp Screw HBH06020	Spring MES3	Wrench HKY40R

* Clamp Torque (N · m) : HBH06020=7.0

RECOMMENDED CUTTING CONDITIONS

	Work Material	Hardness	Grade	Cutting Speed (m/min)	Feed (mm/rev)
P	Carbon Steel Alloy Steel	180–280HB	VP20MF	120 (100–140)	0.14 (0.03–0.25)
			NX2525	130 (100–160)	0.12 (0.03–0.2)
M	Stainless Steel	≤200HB	VP20MF	120 (100–140)	0.12 (0.03–0.18)
K	Gray Cast Iron	Tensile Strength ≤350MPa	VP20MF	120 (100–140)	0.12 (0.03–0.18)

Note 1) For machining a narrow groove, apply a lower feed within the recommended range.

● : Inventory maintained. ★ : Inventory maintained in Japan.

(10 inserts in one case) (CBN inserts are available in 1 piece in one case.)

INSERTS

Order Number	Stock						Dimensions (mm)					Geometry
	Coated		Cermet		Carbide		CW	CDX	IC	S	RER/L	
	VP20MF		NX2525		UT120T							
	R	L	R	L	R	L						
MGTR/L33125	★	★	★		●	●	1.25	1.2	9.525	4.76	0.2	MGTR/L...
MGTR/L33145	★	★	★		●	★	1.45	1.5	9.525	4.76	0.2	
MGTR/L33150	★	★	★	★	●	●	1.5	3	9.525	4.76	0.2	
MGTR/L33175	★	★	★	★	●	●	1.75	3	9.525	4.76	0.2	
MGTR/L33200	★	★	★	★	●	●	2	3	9.525	4.76	0.2	
MGTR/L33230	★	★			●	●	2.3	3	9.525	4.76	0.2	
MGTR/L33250	★	★	★	★	●	●	2.5	3	9.525	4.76	0.3	
MGTR/L33270	★	★			●	★	2.7	3	9.525	4.76	0.3	
MGTR/L33280	★	★			●	★	2.8	3	9.525	4.76	0.3	
MGTR/L33300	★	★	★	★	●	●	3	3	9.525	4.76	0.3	
MGTR/L33320	★	★			●		3.2	3	9.525	4.76	0.3	
MGTR/L33330		★			●	★	3.3	3	9.525	4.76	0.3	
MGTR/L33350	★	★	★		●	★	3.5	3	9.525	4.76	0.3	
MGTR/L33400	★	★	★	★	●	●	4	3	9.525	4.76	0.3	
MGTR/L43125	★	★	★	★	●	●	1.25	1.2	12.7	4.76	0.2	
MGTR/L43145	★	★		★	●	★	1.45	1.5	12.7	4.76	0.2	
MGTR/L43150	★	★	★	●	●	●	1.5	3	12.7	4.76	0.2	
MGTR/L43175	★	★	★	★	●	●	1.75	3	12.7	4.76	0.2	
MGTR/L43200	★	★	★	●	●	●	2	3	12.7	4.76	0.2	
MGTR/L43230	★	★	●	★	●	●	2.3	3	12.7	4.76	0.2	
MGTR/L43250	★	★	★	★	●	●	2.5	4.5	12.7	4.76	0.3	
MGTR/L43260	★	★	★		●	●	2.6	4.5	12.7	4.76	0.3	
MGTR/L43270	★	★			●	★	2.7	4.5	12.7	4.76	0.3	
MGTR/L43280		★		★	●	●	2.8	4.5	12.7	4.76	0.3	
MGTR/L43300	★	★	★	★	●	●	3	4.5	12.7	4.76	0.3	
MGTR/L43320	★				●	●	3.2	4.5	12.7	4.76	0.3	
MGTR/L43330		★		★	●	●	3.3	4.5	12.7	4.76	0.3	
MGTR/L43350	★	★	★	★	●	●	3.5	4.5	12.7	4.76	0.3	
MGTR/L43400	★	★	★		●	●	4	4.5	12.7	4.76	0.3	
MGTR/L43420	★	★	★		●	●	4.2	4.5	12.7	4.76	0.4	
MGTR/L43430	★	★	★		●	●	4.3	4.5	12.7	4.76	0.4	
MGTR/L43450	★	★	●	★	●	●	4.5	4.5	12.7	4.76	0.4	
MGTR/L43470	★	★	★	★	●	★	4.7	4.5	12.7	4.76	0.4	
MGTR/L44500	★	★			●	★	5	4.5	12.7	6.35	0.4	
MGTR/L44550	★				●		5.5	4.5	12.7	6.35	0.4	
MGTR/L44600	★				●	●	6	4.5	12.7	6.35	0.4	

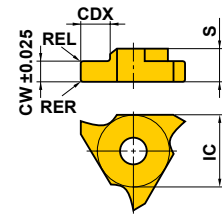

Right hand insert shown.

CBN Insert

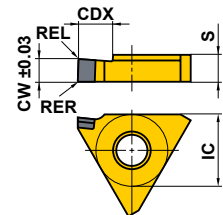

Right hand insert only.
*RER=0.2 REL=0.2

T
GROOVING / CUTTING OFF

GROOVING / CUTTING OFF

MICRO-MINI

- Solid carbide type with min. cutting diameter 3.2mm.
- l/d is 5 times the diameter.
- Insert can be ground to suit the application.
- Suitable for a wide range of tooling including threading and grooving.

MICRO-MINI STANDARD (SOLID CARBIDE BORING BAR)

Order Number	Stock	Dimensions (mm)						Geometry
		TF15	CW	DCON	LF	LDRED	DMIN*	
C03FR-BLS	★	2.0	3	80	15	3.2	1.0	
C04FR-BLS	★	2.5	4	80	20	4.2	1.5	
C05HR-BLS	★	3.0	5	100	25	5.2	2.0	

Right hand tool only.

* DMIN : Min. Cutting Diameter

RECOMMENDED CUTTING CONDITIONS

	Work Material	Cutting Speed (m/min)	Feed (mm/rev)	Depth of Cut (mm)	Excescence Quantity (l/d)	Edge Condition	
						Corner Radius or BCH *	Honing *
P	Carbon Steel · Alloy Steel 180-280HB	40 (30-50)	0.05 (-0.1)	0.2 (0.1-0.3)	5	0.1-0.5	0.01-0.05
M	Stainless Steel ≤200HB	40 (30-50)	0.05 (-0.1)	0.2 (0.1-0.3)	5	≤0.4	≤0.03 (Honing not required)
K	Gray Cast Iron ≤350MPa	40 (30-50)	0.05 (-0.05)	0.2 (0.1-0.3)	5	0.1-0.5	0.01-0.05
N	Non-ferrous Metal	80 (60-100)	0.05 (-0.1)	0.3 (0.1-0.5)	5	0.1-0.5	≤0.03 (Honing not required)

* Cutting edge is not honed. Please hone according to the workpiece before machining.

GRINDING THE CUTTING EDGE OF MICRO-MINI

- MICRO-MINI can be used for boring and grooving as it is. But, it can also be reground as shown below.
- For shaping and regrinding, use diamond whetstone approximately #250-#400. Please grind according to application using the figure below as a reference.

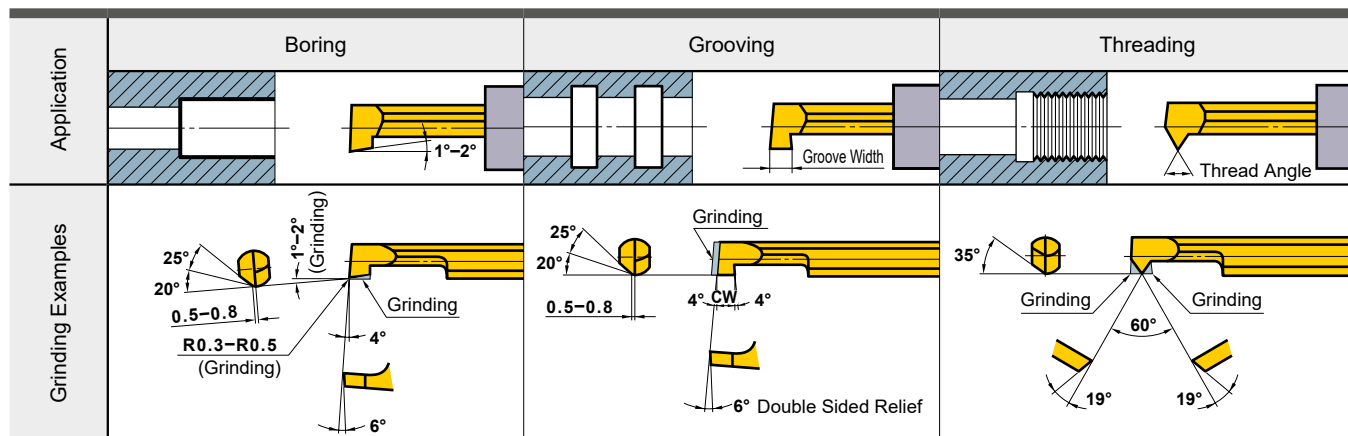

● : Inventory maintained. ★ : Inventory maintained in Japan.

(MICRO MINI is available in 1 piece in one pack.) (MICRO-MINI TWIN is available in 1 piece in one pack.)

MICRO-MINI TWIN

■CG TYPE (Internal Grooving)

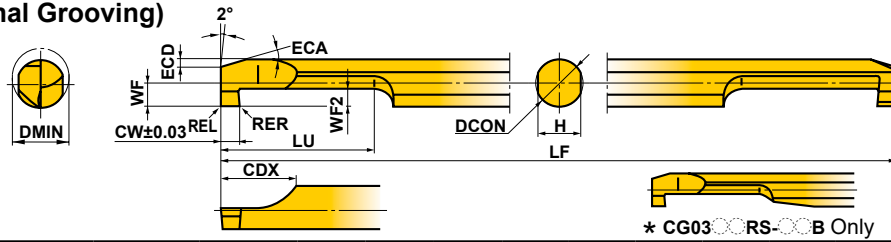

Order Number	Stock		Breaker	Dimensions (mm)											
	Micro Grain Carbide	Coated		DMIN	CW	WF2	RER/L	DCON	LF	LU	CDX	WF	H	ECA	ECD
	TF15	VP15TF													
CG0305RS-10	★	●	Without	3	1	1	0.05	3	50	5	6	1.3	2.7	15°	0.3
CG0305RS-10B	★	★	With	3	1	1	0.05	3	50	5	6	1.3	2.7	15°	0.3
CG0306RS-20	★	★	Without	3	2	1	0.1	3	50	6	6	1.3	2.7	15°	0.3
CG0306RS-20B	★	★	With	3	2	1	0.1	3	50	6	6	1.3	2.7	15°	0.3
CG03RS-10	★	●	Without	3	1	1	0.05	3	50	10	6	1.3	2.7	15°	0.3
CG03RS-10B	★	★	With	3	1	1	0.05	3	50	10	6	1.3	2.7	15°	0.3
CG03RS-20	★	★	Without	3	2	1	0.1	3	50	11	6	1.3	2.7	15°	0.3
CG03RS-20B	★	★	With	3	2	1	0.1	3	50	11	6	1.3	2.7	15°	0.3
CG0407RS-10	★	★	Without	4	1	1.5	0.05	4	60	7	7	1.8	3.6	15°	0.5
CG0407RS-10B	★	★	With	4	1	1.5	0.05	4	60	7	7	1.8	3.6	15°	0.5
CG0408RS-20	★	★	Without	4	2	1.5	0.1	4	60	8	7	1.8	3.6	15°	0.5
CG0408RS-20B	★	★	With	4	2	1.5	0.1	4	60	8	7	1.8	3.6	15°	0.5
CG04RS-10	★	●	Without	4	1	1.5	0.05	4	60	15	7	1.8	3.6	15°	0.5
CG04RS-10B	★	★	With	4	1	1.5	0.05	4	60	15	7	1.8	3.6	15°	0.5
CG04RS-20	★	★	Without	4	2	1.5	0.1	4	60	16	7	1.8	3.6	15°	0.5
CG04RS-20B	★	●	With	4	2	1.5	0.1	4	60	16	7	1.8	3.6	15°	0.5
CG0510RS-10	★	●	Without	5	1	2	0.05	5	70	10	8	2.3	4.5	15°	0.7
CG0510RS-10B	★	●	With	5	1	2	0.05	5	70	10	8	2.3	4.5	15°	0.7
CG0511RS-20	★	●	Without	5	2	2	0.1	5	70	11	8	2.3	4.5	15°	0.7
CG0511RS-20B	★	★	With	5	2	2	0.1	5	70	11	8	2.3	4.5	15°	0.7
CG05RS-10	★	●	Without	5	1	2	0.05	5	70	20	8	2.3	4.5	15°	0.7
CG05RS-10B	★	★	With	5	1	2	0.05	5	70	20	8	2.3	4.5	15°	0.7
CG05RS-20	●	★	Without	5	2	2	0.1	5	70	21	8	2.3	4.5	15°	0.7
CG05RS-20B	★	●	With	5	2	2	0.1	5	70	21	8	2.3	4.5	15°	0.7
CG0610RS-10	★	●	Without	6	1	2	0.05	6	75	10	8	2.8	5.4	15°	0.7
CG0610RS-10B	★	●	With	6	1	2	0.05	6	75	10	8	2.8	5.4	15°	0.7
CG0611RS-20	★	●	Without	6	2	2	0.1	6	75	11	8	2.8	5.4	15°	0.7
CG0611RS-20B	★	●	With	6	2	2	0.1	6	75	11	8	2.8	5.4	15°	0.7
CG06RS-10	★	●	Without	6	1	2	0.05	6	75	20	8	2.8	5.4	15°	0.7
CG06RS-10B	●	●	With	6	1	2	0.05	6	75	20	8	2.8	5.4	15°	0.7
CG06RS-20	★	●	Without	6	2	2	0.1	6	75	21	8	2.8	5.4	15°	0.7
CG06RS-20B	●	●	With	6	2	2	0.1	6	75	21	8	2.8	5.4	15°	0.7
CG0712RS-10	★	●	Without	7	1	2	0.05	7	85	12	8	3.3	6.4	15°	0.7
CG0712RS-10B	★	●	With	7	1	2	0.05	7	85	12	8	3.3	6.4	15°	0.7
CG0713RS-20	★	★	Without	7	2	2	0.1	7	85	13	8	3.3	6.4	15°	0.7
CG0713RS-20B	★	★	With	7	2	2	0.1	7	85	13	8	3.3	6.4	15°	0.7
CG07RS-10	★	★	Without	7	1	2	0.05	7	85	25	8	3.3	6.4	15°	0.7
CG07RS-10B	★	●	With	7	1	2	0.05	7	85	25	8	3.3	6.4	15°	0.7
CG07RS-20	★	●	Without	7	2	2	0.1	7	85	26	8	3.3	6.4	15°	0.7
CG07RS-20B	●	●	With	7	2	2	0.1	7	85	26	8	3.3	6.4	15°	0.7

GROOVING / CUTTING OFF

MICRO-MINI TWIN

RECOMMENDED CUTTING CONDITIONS

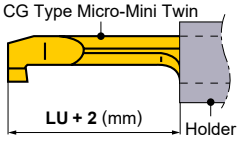
Work Material	Hardness	Cutting Speed (m/min)	Feed (mm/rev)		Recommended Tool Overhang (mm)
			CG03RS/CG04RS	CG05RS/CG06RS/CG07RS	
P Carbon Steel · Alloy Steel	180–280HB	80 (40–120)	0.02 (0.01–0.03)	0.03 (0.01–0.05)	
M Stainless Steel	≤200HB	80 (40–120)	0.02 (0.01–0.03)	0.03 (0.01–0.05)	
K Gray Cast Iron	Tensile Strength ≤350MPa	80 (40–120)	0.03 (0.01–0.05)	0.03 (0.01–0.05)	
N Non-ferrous Metal	—	120 (80–160)	0.03 (0.01–0.05)	0.05 (0.01–0.08)	

Note 1) Wet cutting is recommended.

PRECAUTIONS WHEN USING THE MICRO-MINI TWIN

● When using a holder for general purpose / small automatic lathe:

① To avoid chipping of the 2nd cutting edge take care when inserting the boring bar into the holder. Refer to fig.1. If the 2nd edge contacts the internal face of the holder there is a possibility that it may chip.

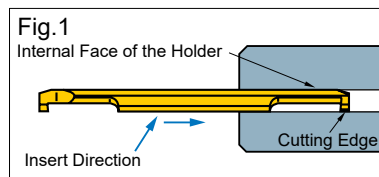

② When using this type of holder, there is a possibility that damage to the shank and the 2nd cutting edge can occur. Make sure that the clamping screws are tightened to the set torque value. Additionally make sure that there is no clamping screw near the 2nd cutting edge as this can break the boring bar.

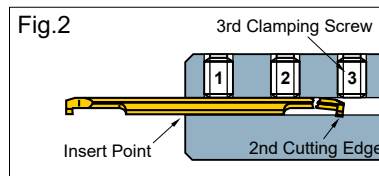

◎ When using Mitsubishi holders

When using holders with a tool overhang of recommended quantity, ensure that the 3rd clamping screw is removed prior to machining. The set torque value for the clamping screw is 2.0 N·m.

● When using a square type holder:

① When installing the boring bar into the holder, tighten the clamp screws after ensuring the flats on the tool holder are parallel to the reference flats on the micro-mini bar. Refer to fig.3.

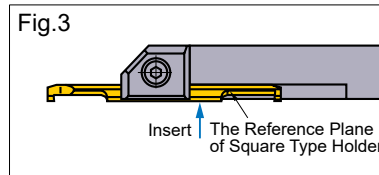

② Make sure that the clamping screws are tightened to the recommended values.

③ Do not tighten the clamp screw without a bar in place, otherwise the bridge will be deformed.

ROUND TYPE HOLDER

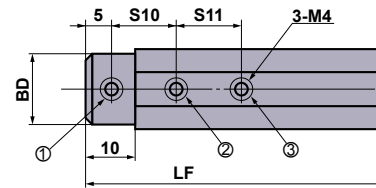
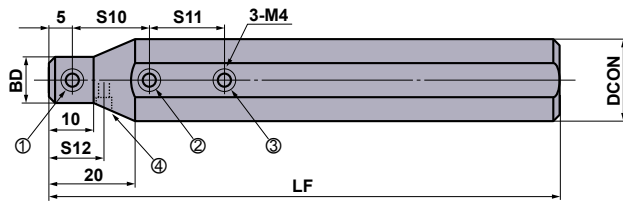

RBH2200N has a temporary set screw for different machine specifications.
(Represented by number 4)

RBH15800N, RBH1600N,
RBH19000N

Order Number	Stock	Dimensions (mm)							MICRO-MINI C	MICRO-MINI TWIN CG	*1 Clamp Screw				Wrench	Torque (N·m)
		DCON	DCONWS	BD	LF	S10	S11	S12			①	②	③	④		
RBH15820N	★	15.875	2	15	100	10	—	—	—	B	B	—	—	HKY20F	2.0	
RBH15830N	★	15.875	3	15	100	10	10	—	03FR-BLS	A	A	A	—	HKY20F	2.0	
RBH15840N	★	15.875	4	15	100	15	15	—	04FR-BLS	A	A	A	—	HKY20F	2.0	
RBH15850N	★	15.875	5	15	100	15	15	—	05HR-BLS	A	A	A	—	HKY20F	2.0	
RBH15860N	★	15.875	6	15	100	15	15	—	—	A	A	A	—	HKY20F	2.0	
RBH15870N	★	15.875	7	15	100	20	20	—	—	A	A	A	—	HKY20F	2.0	
RBH15880N	★	15.875	8	15	100	20	20	—	—	D	D	D	—	HKY20F	2.0	
RBH1620N	●	16	2	15	100	10	—	—	—	B	B	—	—	HKY20F	2.0	
RBH1630N	●	16	3	15	100	10	10	—	03FR-BLS	A	A	A	—	HKY20F	2.0	
RBH1640N	●	16	4	15	100	15	15	—	04FR-BLS	A	A	A	—	HKY20F	2.0	
RBH1650N	●	16	5	15	100	15	15	—	05HR-BLS	A	A	A	—	HKY20F	2.0	
RBH1660N	●	16	6	15	100	15	15	—	—	A	A	A	—	HKY20F	2.0	
RBH1670N	●	16	7	15	100	20	20	—	—	A	A	A	—	HKY20F	2.0	
RBH1680N	★	16	8	15	100	20	20	—	—	D	D	D	—	HKY20F	2.0	
RBH19020N	★	19.05	2	18	125	10	—	—	—	C	C	—	—	HKY20F	2.0	
RBH19030N	★	19.05	3	18	125	10	10	—	03FR-BLS	B	B	B	—	HKY20F	2.0	
RBH19040N	★	19.05	4	18	125	15	15	—	04FR-BLS	B	B	B	—	HKY20F	2.0	
RBH19050N	★	19.05	5	18	125	15	15	—	05HR-BLS	B	B	B	—	HKY20F	2.0	
RBH19060N	★	19.05	6	18	125	15	15	—	—	B	B	B	—	HKY20F	2.0	
RBH19070N	★	19.05	7	18	125	20	20	—	—	B	B	B	—	HKY20F	2.0	
RBH19080N	★	19.05	8	18	125	20	20	—	—	A	A	A	—	HKY20F	2.0	
RBH2020N	★	20	2	11	125	10	—	—	—	A	A	—	—	HKY20F	2.0	
RBH2030N	★	20	3	12	125	10	10	—	03FR-BLS	A	A	B	—	HKY20F	2.0	
RBH2040N	★	20	4	13	125	15	15	—	04FR-BLS	A	B	B	—	HKY20F	2.0	
RBH2050N	★	20	5	14	125	15	15	—	05HR-BLS	A	B	B	—	HKY20F	2.0	
RBH2060N	★	20	6	15	125	15	15	—	—	A	B	B	—	HKY20F	2.0	
RBH2070N	★	20	7	16	125	20	20	—	—	A	B	B	—	HKY20F	2.0	
RBH2080N	★	20	8	17	125	20	20	—	—	A	A	A	—	HKY20F	2.0	
RBH2220N	★	22	2	11	125	10	—	10	—	A	B	—	A	HKY20F	2.0	
RBH2230N	★	22	3	12	125	10	10	10	03FR-BLS	A	B	C	A	HKY20F	2.0	
RBH2240N	★	22	4	13	125	15	15	12.5	04FR-BLS	A	B	B	A	HKY20F	2.0	
RBH2250N	★	22	5	14	125	15	15	12.5	05HR-BLS	A	B	B	A	HKY20F	2.0	
RBH2260N	★	22	6	15	125	15	15	15	—	A	B	B	A	HKY20F	2.0	
RBH2270N	★	22	7	16	125	20	20	15	—	A	B	B	A	HKY20F	2.0	
RBH2280N	★	22	8	17	125	20	20	15	—	A	B	B	A	HKY20F	2.0	
RBH2520N	★	25	2	11	150	10	—	—	—	A	B	—	—	HKY20F	2.0	
RBH2530N	★	25	3	12	150	10	10	—	03FR-BLS	A	B	C	—	HKY20F	2.0	
RBH2540N	★	25	4	13	150	15	15	—	04FR-BLS	A	C	C	—	HKY20F	2.0	
RBH2550N	★	25	5	14	150	15	15	—	05HR-BLS	A	C	C	—	HKY20F	2.0	
RBH2560N	★	25	6	15	150	15	15	—	—	A	C	C	—	HKY20F	2.0	
RBH2570N	★	25	7	16	150	20	20	—	—	A	C	C	—	HKY20F	2.0	
RBH2580N	★	25	8	17	150	20	20	—	—	A	B	B	—	HKY20F	2.0	
RBH25420N	★	25.4	2	11	150	10	—	—	—	A	B	—	—	HKY20F	2.0	
RBH25430N	★	25.4	3	12	150	10	10	—	03FR-BLS	A	B	C	—	HKY20F	2.0	
RBH25440N	★	25.4	4	13	150	15	15	—	04FR-BLS	A	C	C	—	HKY20F	2.0	
RBH25450N	★	25.4	5	14	150	15	15	—	05HR-BLS	A	C	C	—	HKY20F	2.0	
RBH25460N	★	25.4	6	15	150	15	15	—	—	A	C	C	—	HKY20F	2.0	
RBH25470N	★	25.4	7	16	150	20	20	—	—	A	C	C	—	HKY20F	2.0	
RBH25480N	★	25.4	8	17	150	20	20	—	—	A	B	B	—	HKY20F	2.0	

*1 Order number of clamp screw A=HSS04004, B=HSS04006, C=HSS04008

F

GROOVING / CUTTING OFF

SQUARE TYPE HOLDER

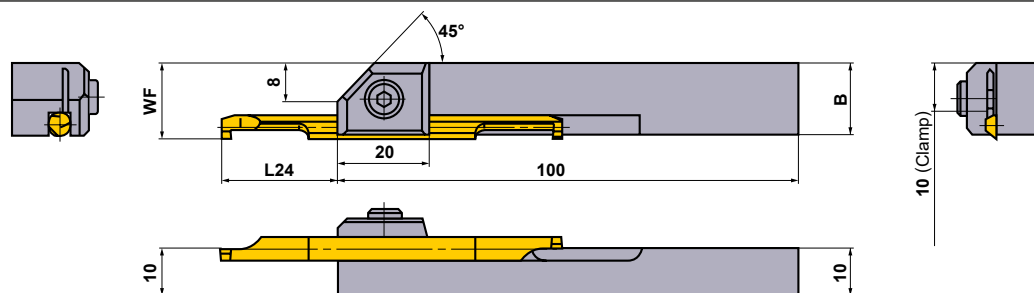

Order Number	Stock	Dimensions (mm)				MICRO-MINI TWIN CG	Clamp Screw	Wrench	Torque (N · m)
		MICRO-MINI TWIN CG							
		B	WF	L24 *					
Width of Cutting Edge 1mm	Width of Cutting Edge 2mm								
SBH1030R	★	13.8	13.8	13—17.5 (14)	14—16.5 (15)	03RS-10(B),03RS-20(B)	HSC05012	HKY40R	9.5
SBH1040R	★	14.7	14.8	18—22.5 (19)	19—21.5 (20)	04RS-10(B),04RS-20(B)	HSC05012	HKY40R	9.5
SBH1050R	★	15.6	15.8	23—27.5 (24)	24—26.5 (25)	05RS-10(B),05RS-20(B)	HSC05012	HKY40R	9.5
SBH1060R	★	16.5	16.8	23—32.5 (24)	24—31.5 (25)	06RS-10(B),06RS-20(B)	HSC05012	HKY40R	9.5
SBH1070R	★	17.4	17.8	28—38 (29)	29—37 (30)	07RS-10(B),07RS-20(B)	HSC05012	HKY40R	9.5

* L24 is the length of overhang for sufficient clamping, and () is the recommended length for steel machining and for general purpose.
 Note 1) The MICRO-DEX and the MICRO-MINI cannot be fitted to square holders.

F

GROOVING / CUTTING OFF

Memo

A series of horizontal dashed lines for writing, spanning the width of the page.

HOW TO READ THE STANDARD OF THREADING TOOLS

● How this section page is organised

- ① Classified according to external or internal applications.
- ② Sub-classified according to product series.
(Refer to the index on the next page.)

FIGURE SHOWING THE TOOLING APPLICATION
Uses illustrations and arrows to depict the available machining applications, such as external and internal threading.

TYPE OF TOOL HOLDER
Indicates the initial letters for the order number and cutting applications.

TITLE OF PRODUCT

INDICATION OF EXTERNAL/INTERNAL APPLICATION

PRODUCT SECTION

PRODUCT FEATURES

STANDARDS FOR APPLICABLE INSERTS
Indicates stock status, dimensions, etc. for applicable inserts.

INTERNAL THREADING
MMTI TYPE BORING BARS
Minimum cutting diameter: 13mm.
Various insert types.
Hollow design insert.
Available with a wiper cutting edge to provide a precise thread geometry.
Able to change lead angle by replacing shim.

Order Number	Insert Number	Dimensions (mm)	Tool Holder
MMTR1316AK11-SP14	MMT11R	1.5 18 125 25 8.7 15 13	TS23
MMTR1316AK11-SP25	MMT11R	2.5 18 125 25 8.7 15 13	TS23
MMTR1316AK11-SP35	MMT11R	3.5 18 125 25 8.7 15 13	TS23
MMTR1916AM11-SP15	MMT11R	1.5 18 150 32 9.7 15 15	TS23
MMTR1916AM11-SP25	MMT11R	2.5 18 150 32 9.7 15 15	TS23
MMTR1916AM11-SP35	MMT11R	3.5 18 150 32 9.7 15 15	TS23
MMTR1916AM16-SP15	MMT11R	1.5 18 150 40 12.2 15 19	CS30860T
MMTR1916AM16-SP25	MMT11R	2.5 18 150 40 12.2 15 19	CS30860T
MMTR1916AM16-SP35	MMT11R	3.5 18 150 40 12.2 15 19	CS30860T
MMTR2420AQ16-C	MMT16R	1.5 20 180 40 14.2 19 24	SETN51 SETS91 CR4
MMTR2925AS16-C	MMT22R	1.5 25 200 60 16.7 23.4 29	SETN51 SETS91 CR4
MMTR3232AP16-C	MMT22R	1.5 32 250 48 20.0 30.2 37	SETN51 SETS91 CR4
MMTR2420AQ22-SP15	MMT22R	1.5 20 180 50 15.5 19 24	TS43
MMTR2420AQ22-SP25	MMT22R	2.5 20 180 50 15.5 19 24	TS43
MMTR2420AQ22-SP35	MMT22R	3.5 20 180 50 15.5 19 24	TS43
MMTR3025AR22-C	MMT22R	1.5 25 200 38 17.8 23.4 30	SETN51 SETS91 CR4
MMTR3832AR22-C	MMT22R	1.5 32 250 48 21.8 30.4 38	SETN51 SETS91 CR4
MMTR4640AZ22-C	MMT22R	1.5 40 300 60 26.2 38 48	SETN51 SETS91 CR4

Note 1) Select and use a shim as shown below (bold separately), depending on the lead angle.
* A screw on tool holder uses no shim. (The holder body has a lead angle.) Use a tool holder with the appropriate lead angle.
* Min. cutting diameter (DMIN) shows the internal hole diameter, not the thread diameter.
* Clamp Torque (N·m): TS25=1.0, CS30860T=3.5, SETS91=3.5, TS43=3.5, SETS61=5.0, HFC03006=1.5, HFC04008=2.2

Lead Angle (°)	Order Number	Shim (mm)	Applicable Holder	Lead Angle (°)	Order Number	Shim (mm)	Applicable Holder
-1.5	CT132TN15	0	CT132TN15	-1.5	CT143TN15	0	CT143TN15
-0.5	CT132TN15	0	CT132TN15	-0.5	CT143TN15	0	CT143TN15
0.5	CT132TP15	0	CT132TP15	0.5	CT143TP15	0	CT143TP15
1.5	CT132TP15	0	CT132TP15	1.5	CT143TP15	0	CT143TP15
2.5	CT132TP25	1	CT16-C	2.5	CT143TP25	1	CT22-C
3.5	CT132TP35	2	CT16-C	3.5	CT143TP35	2	CT22-C
4.5	CT132TP45	3	CT16-C	4.5	CT143TP45	3	CT22-C

RECOMMENDED CUTTING CONDITIONS

Work Material	Hardness	Grade	Cutting Speed (min/m)	Work Material	Hardness	Grade	Cutting Speed (min/m)
Mild Steel	≤180HB	VP16MP	150 (50-250)	Heat-Resistant Alloy	-	VP16SPT	45 (15-30)
Carbon Steel Alloy Steel	180-280HB	VP16MP	140 (50-250)	Titanium Alloy	-	VP16SPT	60 (20-80)
Stainless Steel	≤200HB	VP16SPT	80 (50-100)	Heat-Treated Alloy	45-55HRC	VP16SPT	50 (30-70)
Gray Cast Iron	≤200HB	VP16SPT	80 (50-100)				

Legend for Stock Status Mark: Inventory maintained, Inventory maintained in Japan, (if inserts in one case).
How to Select a Shim: G012, MMT Series Order Number, G016.

MMT M-CLASS INSERTS WITH 3-D CHIP BREAKERS

Type	Order Number	Pitch	IC	S	PDY	PDX	RE	Total Cutting Depth (mm)	Geometry
Partial Profile ISO	MMT11RA60-S	0.5-1.5	48-16	6.35	3.04	0.8	0.9	0.03	Partial form
	MMT16RA60-S	0.5-1.5	48-16	9.525	3.44	0.8	0.9	0.03	Partial form
	MMT16RG60-S	1.75-3.0	14-B	9.525	3.44	1.2	1.7	0.11	Partial form
Partial Profile SP	MMT11RA55-S	0.5-1.5	48-16	6.35	3.04	0.8	0.9	0.07	Partial form
	MMT16RA55-S	0.5-1.5	48-16	9.525	3.44	0.8	0.9	0.07	Partial form
	MMT16RG55-S	1.75-3.0	14-B	9.525	3.44	1.2	1.7	0.21	Partial form
ISO Metric	MMT11R100ISO-S	1.0	6.35	3.04	0.6	0.7	0.06	0.56	Full form
	MMT11R120ISO-S	1.25	6.35	3.04	0.8	0.9	0.08	0.72	Full form
	MMT11R150ISO-S	1.5	6.35	3.04	0.8	1.0	0.10	0.87	Full form
	MMT16R100ISO-S	1.0	9.525	3.44	0.6	0.7	0.06	0.56	Full form
	MMT16R120ISO-S	1.25	9.525	3.44	0.8	0.9	0.08	0.72	Full form
	MMT16R150ISO-S	1.5	9.525	3.44	0.8	1.0	0.10	0.87	Full form
	MMT16R170ISO-S	1.75	9.525	3.44	0.9	1.2	0.11	1.01	Full form
	MMT16R200ISO-S	2.0	9.525	3.44	1.0	1.3	0.13	1.15	Full form
	MMT16R250ISO-S	2.5	9.525	3.44	1.1	1.5	0.17	1.44	Full form
	MMT16R300ISO-S	3.0	9.525	3.44	1.1	1.5	0.20	1.73	Full form
American UN	MMT16R160UN-S	16	9.525	3.44	0.9	1.1	0.11	0.92	Full form
	MMT16R140UN-S	14	9.525	3.44	0.9	1.2	0.12	1.05	Full form
	MMT16R120UN-S	12	9.525	3.44	1.1	1.4	0.14	1.22	Full form
American BSPP	MMT16R100W-S	19	9.525	3.44	0.8	1.0	0.18	0.86	Full form
	MMT16R140W-S	14	9.525	3.44	1.0	1.2	0.25	1.16	Full form
	MMT16R110W-S	11	9.525	3.44	1.1	1.5	0.32	1.48	Full form
BSPT	MMT16R190BSPT-S	19	9.525	3.44	0.8	0.9	0.18	0.86	Full form
	MMT16R140BSPT-S	14	9.525	3.44	1.0	1.2	0.25	1.16	Full form
	MMT16R110BSPT-S	11	9.525	3.44	1.1	1.5	0.32	1.48	Full form

IDENTIFICATION

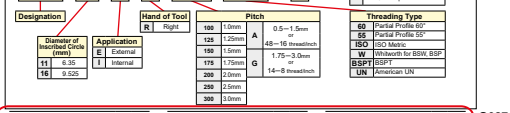

LEGEND FOR STOCK STATUS MARK
Is shown on the left hand page of each double-page spread.

PRODUCT STANDARDS
Indicates order numbers, stock status (per right/left hand), applicable inserts, holder dimensions, and spare parts.

PAGE REFERENCE
Indicates reference pages, including the above, on the right hand page of each double-page spread.

RECOMMENDED CUTTING CONDITIONS
For each work material classification, indicates recommended cutting conditions according to the ISO categories for cutting grades, P, M, K, S and H.

TURNING TOOLS

THREADING

CLASSIFICATION (EXTERNAL).....	G002
CLASSIFICATION (INTERNAL).....	G003
CROSS REFERENCE THREAD PITCH	
EXTERNAL	G004
INTERNAL	G006
STANDARD THREAD AND CORRESPONDING INSERT / HOLDER	G008

STANDARD OF THREADING TOOLS

MMT SERIES

FEATURES	G010
CUTTING CONDITIONS.....	G012
STANDARD OF DEPTH OF CUT.....	G014

EXTERNAL THREADING

MMTE HOLDER	G019
MT HOLDER	G024

INTERNAL THREADING

MMTI TYPE BORING BARS.....	G026
MICRO-MINI TWIN BORING BARS	G031

*Alphabetical order index

G031	CT
G020	MMT (EXTERNAL INSERTS)
G027	MMT (INTERNAL INSERTS)
G019	MMTE
G026	MMTI
G024	MT1
G024	MTH
G025	MTT (EXTERNAL INSERTS)
G033	RBH
G032	SBH



CLASSIFICATION (EXTERNAL)

Name of Tool Holder	Insert Shape	Features	Shank Size (H x W x L) (mm)
MMTE Holder   		<ul style="list-style-type: none"> ● Various insert types. ● Precision class insert. ● Available with a wiper cutting edge to provide a precise thread geometry. ● Able to change lead angle by replacing the shim. 	12 x 12 x 100 16 x 16 x 100 20 x 20 x 125 25 x 25 x 150 32 x 32 x 170
MT Holder   		<ul style="list-style-type: none"> ● Clamp-on type. ● Precision class insert. ● Positive insert suffers from negligible chattering and thus produces a good finished surface. 	16 x 16 x 100 20 x 20 x 125 25 x 25 x 150 32 x 32 x 170
SMALL TOOLS	TTAH   	<ul style="list-style-type: none"> ● Tools to be used on gang type tool posts. ● Small Shank : 8mm—16mm ● High rigidity vertical insert design. ● Screw is designed for use on both front and back to enable back clamping. ● Most suitable for threading diameters of 2mm or smaller. ● Screw-on type. 	8 x 10 x 120 10 x 10 x 120 12 x 12 x 120 16 x 16 x 120
	CSVH   	<ul style="list-style-type: none"> ● Tools to be used on cam type tool posts. ● Small Shank : 7mm—12mm ● Single holder for front turning, back turning, grooving, threading and cutting off operations. ● The most suitable for machining of small parts with diameter 5mm or less. ● Screw-on type. 	7 x 7 x 140 8 x 8 x 140 9.5 x 9.5 x 140 10 x 10 x 140 12 x 12 x 140

CLASSIFICATION (INTERNAL)

Name of Tool Holder	Insert Shape	Features	Shank Size (Dia. x L x Min. Cutting Dia.) (mm)
MMTI  		<ul style="list-style-type: none"> ● Minimum cutting diameter 13mm. ● Various insert types. ● Precision class insert. ● Available with a wiper cutting edge to provide a precise thread geometry. ● Able to change lead angle by replacing shim. 	16 x 125 x 13 16 x 150 x 15 20 x 170 x 24 25 x 200 x 29 32 x 250 x 37 40 x 300 x 46
MICRO-MINI TWIN Boring Bars  	—	<ul style="list-style-type: none"> ● Minimum cutting diameter 3mm. ● Solid carbide type. ● Economical two cutting edges type. 	3 x 50 x 3 4 x 60 x 4.5 5 x 70 x 6 6 x 75 x 7
MICRO-MINI Boring Bars  	—	<ul style="list-style-type: none"> ● Minimum cutting diameter 3.2mm. ● Solid carbide type. ● Insert can be ground to suit the application. 	3 x 80 x 3.2 4 x 80 x 4.2 5 x 100 x 5.2



CROSS REFERENCE THREAD PITCH (EXTERNAL)

Application		General machining				Pipe fittings and couplings for gas and water	
Type	Partial Profile 60°	Partial Profile 55°	ISO Metric	American UN	Parallel Pipe Thread Whitworth for BSW, BSP	American NPT	
Symbol	M UNC UNF	W	M	UNC UNF	G(PF) Rp(PS) W	NPT	
Pitch	mm (thread/inch)	thread/inch	mm	thread/inch	thread/inch	thread/inch	
Holder							
MMT Holder G019	Full form	—	—	0.5 – 5.0	32 – 5	28 – 5	27, 18, 14 11.5, 8
	Partial form	0.5 – 5.0 (48 – 5)	48 – 5	0.5 – 5.0	48 – 5	—	—
MT Holder G024	Partial form	0.25 – 4.5 (64 – 6)	20 – 9	0.25 – 4.5	64 – 6	—	—

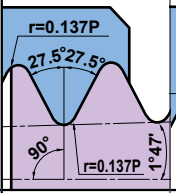
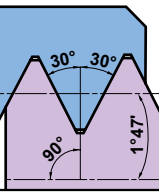
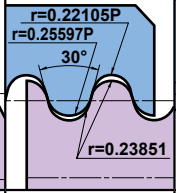
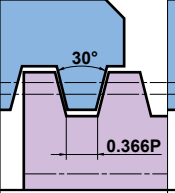
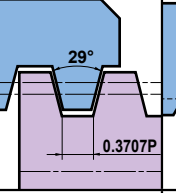
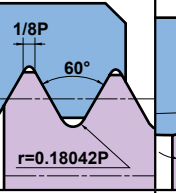
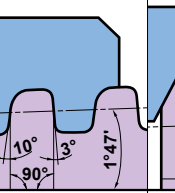
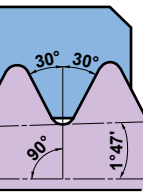

	Steam, gas and water pipes		Pipe couplings for food and fire fighting industries	Motion transmissions		Aircraft and aerospace	Oil and gas	
	Taper Pipe Thread BSPT	American NPTF	Round DIN 405	ISO Trapezoidal 30°	American ACME	UNJ	API Buttress Casing	API Round Casing&Tubing
								
	R(PT) Rc(PT) Rp	NPTF	Rd	Tr (TM)	ACME (Tw)	UNJ	BCSG	CSG LCSG
	thread/inch	thread/inch	thread/inch	mm	thread/inch	thread/inch	thread/inch	thread/inch
	28, 19 14, 11	27, 18, 14 11.5, 8	10, 8, 6, 4	1.5, 2 3, 4, 5	12, 10 8, 6, 5	32–8	5	10, 8
	–	–	–	–	–	–	–	–
	–	–	–	–	–	–	–	–

CROSS REFERENCE THREAD PITCH (INTERNAL)

Application		General machining				Pipe fittings and couplings for gas and water	
Type		Partial Profile 60°	Partial Profile 55°	ISO Metric	American UN	Parallel Pipe Thread Whitworth for BSW, BSP	American NPT
Symbol		M UNC UNF	W	M	UNC UNF	G(PF) Rp(PS) W	NPT
Pitch		mm (thread/inch)	thread/inch	mm	thread/inch	thread/inch	thread/inch
Holder							
MMT Boring Bar 	Full form	—	—	0.5–5.0	32–5	28–5	27, 18, 14 11.5, 8
	Partial form	0.5–5.0 (48–5)	48–5	0.5–5.0	48–5	—	—
MICRO-MINI TWIN 	Partial form	0.5–1.75 (36–16)	—	0.5–1.75	36–16	—	—

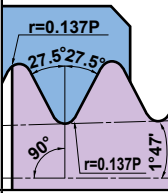
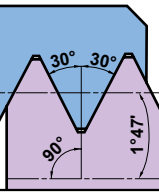
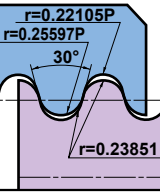
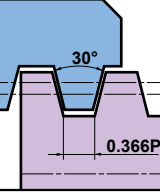
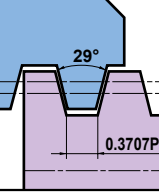
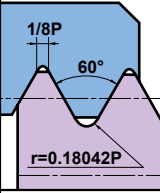
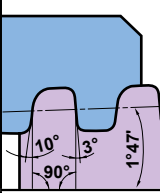
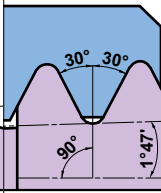

THREADING

	Steam, gas and water pipes		Pipe couplings for food and fire fighting industries	Motion transmissions		Aircraft and aerospace	Oil and gas	
	Taper Pipe Thread BSPT	American NPTF	Round DIN 405	ISO Trapezoidal 30°	American ACME	UNJ	API Buttress Casing	API Round Casing&Tubing
								
	R(PT) Rc(PT) Rp	NPTF	Rd	Tr (TM)	ACME (Tw)	UNJ	BCSG	CSG LCSG
	thread/inch	thread/inch	thread/inch	mm	thread/inch	thread/inch	thread/inch	thread/inch
	19, 14, 11	14, 11.5, 8	10, 8 6, 4	1.5, 2 3, 4, 5	12, 10 8, 6, 5	—	5	10, 8
	—	—	—	—	—	*	—	—
	—	—	—	—	—	—	—	—

* When machining an internal UNJ thread, cut an internal hole with the appropriate diameter. Then machine with 60° American UN. In this case, a full form type insert cannot be used.

STANDARD THREAD AND CORRESPONDING INSERT / HOLDER

Thread Name	Standard Thread Type	Type	Ext./Int.	Insert Number	Wiper/General	Tool Holder	Page		
ISO Metric	<p> $H=0.866025P$ $d_2=d-0.649519P$ $H_1=0.541266P$ $d_1=d-1.082532P$ $D=d$ $D_2=d_2$ $D_1=d_1$ </p>	M	Ext.	MMT $\odot\odot$ ER $\odot\odot$ ISO	Wiper	MMTER $\odot\odot\odot\odot\odot$ -C	G019		
				MMT $\odot\odot$ ER $\odot\odot$ ISO-S	Wiper				
				MMT $\odot\odot$ ER $\odot\odot$ 60	General				
				MMT $\odot\odot$ ER $\odot\odot$ 60-S	General				
		M	Int.	Ext.	MTTR/L4360 $\odot\odot$	General	MTHR/L $\odot\odot\odot\odot\odot$ 4 MT1R/L $\odot\odot\odot\odot\odot$ 4	G024	
					Int.	MMT $\odot\odot$ IR $\odot\odot$ ISO	Wiper	MMTIR $\odot\odot$ A $\odot\odot\odot$ -SP \odot MMTIR $\odot\odot$ A \odot 16-C	G026
						MMT $\odot\odot$ IR $\odot\odot$ ISO-S	Wiper		
						MMT $\odot\odot$ IR $\odot\odot$ 60	General		
MMT $\odot\odot$ IR $\odot\odot$ 60-S	General								
American UN	<p> $H=0.866025 \times 25.4/n$ $d_2=(d-0.649519/n) \times 25.4$ $H_1=0.541266 \times 25.4/n$ $d_1=(d-1.082532/n) \times 25.4$ $d=(d) \times 25.4$ $D=d$ $D_2=d_2$ $D_1=d_1$ $P=25.4/\text{thread}$ </p>	UNC UNF	Ext.	MMT $\odot\odot$ ER $\odot\odot$ UN	Wiper	MMTER $\odot\odot\odot\odot\odot$ -C	G019		
				MMT $\odot\odot$ ER $\odot\odot$ UN-S	Wiper				
				MMT $\odot\odot$ ER $\odot\odot$ 60	General				
				MMT $\odot\odot$ ER $\odot\odot$ 60-S	General				
		UNC UNF	Int.	Ext.	MTTR/L4360 $\odot\odot$	General	MTHR/L $\odot\odot\odot\odot\odot$ 4 MT1R/L $\odot\odot\odot\odot\odot$ 4	G024	
					Int.	MMT $\odot\odot$ IR $\odot\odot$ UN	Wiper	MMTIR $\odot\odot$ A $\odot\odot\odot$ -SP \odot MMTIR $\odot\odot$ A \odot 16-C	G026
						MMT $\odot\odot$ IR $\odot\odot$ UN-S	Wiper		
						MMT $\odot\odot$ IR $\odot\odot$ 60	General		
MMT $\odot\odot$ IR $\odot\odot$ 60-S	General								
Whitworth for BSW, BSP	<p> $H=0.9605P$ $d_2=d-H_1$ $d_1=d-2H_1$ $r=0.1373P$ $H_1=0.6403P$ $D_1=d_1+2 \times 0.0769H$ $D=d$ $D_2=d_2$ $D_1=d_1$ $P=25.4/\text{thread}$ </p>	W	Ext.	MMT $\odot\odot$ ER $\odot\odot$ W	Wiper	MMTER $\odot\odot\odot\odot\odot$ -C	G019		
				MMT $\odot\odot$ ER $\odot\odot$ W-S	Wiper				
				MMT $\odot\odot$ ER $\odot\odot$ 55	General				
				MMT $\odot\odot$ ER $\odot\odot$ 55-S	General				
		W	Int.	Ext.	MTTR/L4355 $\odot\odot$	General	MTHR/L $\odot\odot\odot\odot\odot$ 4 MT1R/L $\odot\odot\odot\odot\odot$ 4	G024	
					Int.	MMT $\odot\odot$ IR $\odot\odot$ W	Wiper	MMTIR $\odot\odot$ A $\odot\odot\odot$ -SP \odot MMTIR $\odot\odot$ A \odot 16-C	G026
						MMT $\odot\odot$ IR $\odot\odot$ W-S	Wiper		
						MMT $\odot\odot$ IR $\odot\odot$ 55	General		
MMT $\odot\odot$ IR $\odot\odot$ 55-S	General								

Wiper : Insert order number is determined by the selected pitch.
 General : An insert is applicable to several pitch types.

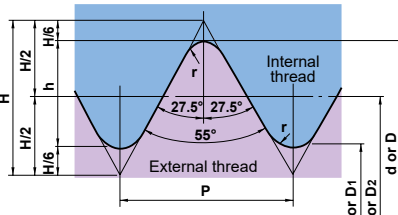
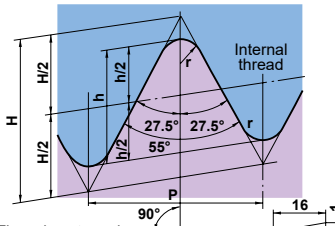
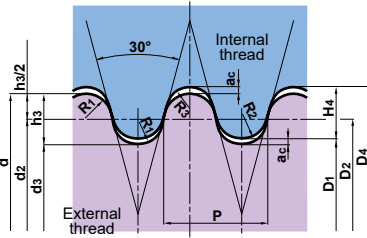
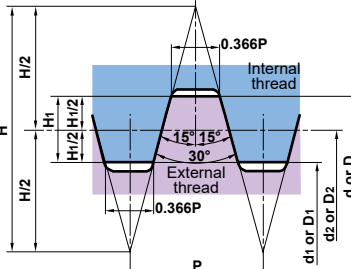
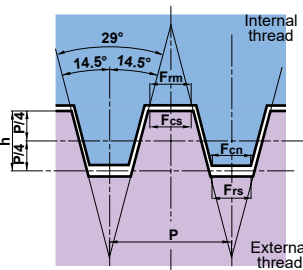
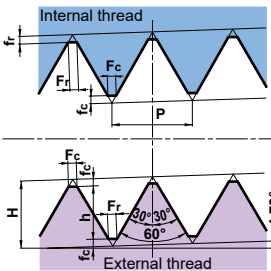

Thread Name	Standard Thread Type	Type	Ext./Int.	Insert Number	Wiper/General	Tool Holder	Page
Parallel Pipe Thread	 <p>$H=0.960491P$ $d_2=d-h$ $d_1=d-2h$ $r=0.137329P$ $h=0.640327$ $D=d$ $D_2=d_2$ $D_1=d_1$ 25.4/ thread</p>	PF G Rp	Ext.	MMT $\odot\odot$ ER $\odot\odot\odot$ W	Wiper	MMTER $\odot\odot\odot\odot\odot\odot$ -C	G019
				MMT $\odot\odot$ ER $\odot\odot\odot$ W-S	Wiper		
			Int.	MMT $\odot\odot$ IR $\odot\odot\odot$ W	Wiper	MMTIR $\odot\odot$ A $\odot\odot\odot$ -SP \odot MMTIR $\odot\odot$ A $\odot\odot$ 16-C	G026
				MMT $\odot\odot$ IR $\odot\odot\odot$ W-S	Wiper		
BSPT	 <p>$H=0.960237P$ $h=0.640327$ $r=0.137278P$ $P=25.4/$ thread</p>	BSPT	Ext.	MMT $\odot\odot$ ER $\odot\odot\odot$ BSPT	Wiper	MMTER $\odot\odot\odot\odot\odot\odot$ -C	G019
				MMT $\odot\odot$ ER $\odot\odot\odot$ BSPT-S	Wiper		
			Int.	MMT $\odot\odot$ IR $\odot\odot\odot$ BSPT	Wiper	MMTIR $\odot\odot$ A $\odot\odot\odot$ -SP \odot MMTIR $\odot\odot$ A $\odot\odot$ 16-C	G026
				MMT $\odot\odot$ IR $\odot\odot\odot$ BSPT-S	Wiper		
Round DIN 405	 <p>$a_c=0.05 \times P$ $h_3=H_4=0.5 \times P$ $R_1=0.238507 \times P$ $R_2=0.255967 \times P$ $R_3=0.221047 \times P$</p>	Rd	Ext.	MMT $\odot\odot$ ER $\odot\odot\odot$ RD	Wiper	MMTER $\odot\odot\odot\odot\odot\odot$ -C	G019
			Int.	MMT $\odot\odot$ IR $\odot\odot\odot$ RD	Wiper	MMTIR $\odot\odot$ A $\odot\odot\odot$ -SP \odot MMTIR $\odot\odot$ A $\odot\odot$ 16-C	G026
ISO Trapezoidal 30°		Tr	Ext.	MMT $\odot\odot$ ER $\odot\odot\odot$ TR	Wiper	MMTER $\odot\odot\odot\odot\odot\odot$ -C	G019
			Int.	MMT $\odot\odot$ IR $\odot\odot\odot$ TR	Wiper	MMTIR $\odot\odot$ A $\odot\odot\odot$ -SP \odot MMTIR $\odot\odot$ A $\odot\odot$ 16-C	G026
American ACME		ACME	Ext.	MMT $\odot\odot$ ER $\odot\odot\odot$ ACME	Wiper	MMTER $\odot\odot\odot\odot\odot\odot$ -C	G019
			Int.	MMT $\odot\odot$ IR $\odot\odot\odot$ TACME	Wiper	MMTIR $\odot\odot$ A $\odot\odot\odot$ -SP \odot MMTIR $\odot\odot$ A $\odot\odot$ 16-C	G026
American NPT	 <p>$H=0.866025P$ $h=0.800000p$</p>	NPT	Ext.	MMT $\odot\odot$ ER $\odot\odot\odot$ NPT	Wiper	MMTER $\odot\odot\odot\odot\odot\odot$ -C	G019
			Int.	MMT $\odot\odot$ IR $\odot\odot\odot$ NPT	Wiper	MMTIR $\odot\odot$ A $\odot\odot\odot$ -SP \odot MMTIR $\odot\odot$ A $\odot\odot$ 16-C	G026

Wiper : Insert order number is determined by the selected pitch.
General : An insert is applicable to several pitch types.

FEATURES OF MMT SERIES

■ A WIDE VARIETY OF PRODUCTS

Mitsubishi Miracle Threading (MMT) series.

M-CLASS INSERTS WITH 3-D CHIPBREAKERS



M UNC UNF W
G Rp R Rc

G-CLASS GROUND INSERTS

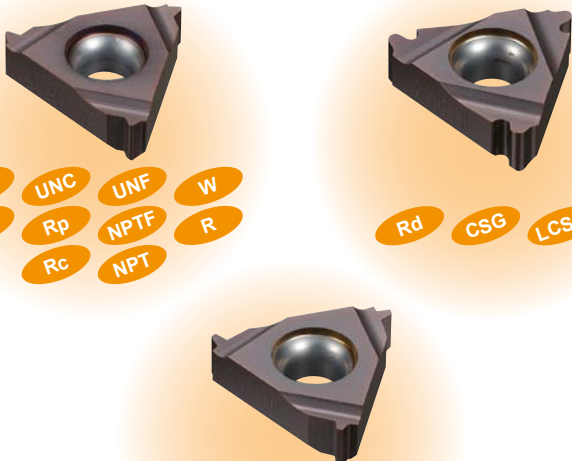

M UNC UNF W
G Rp NPTF R
Rc NPT
Rd CSG LCSG
Tr ACME BCSG

THREADING

■ IDEAL CHIP CONTROL EVEN DURING THE LATTER HALF OF PASSES WHEN CONTINUOUS CHIPS ARE USUALLY PRODUCED. (M-CLASS INSERTS WITH 3-D CHIPBREAKERS)

ISO metric external thread pitch 1.5mm Final pass (6th pass)

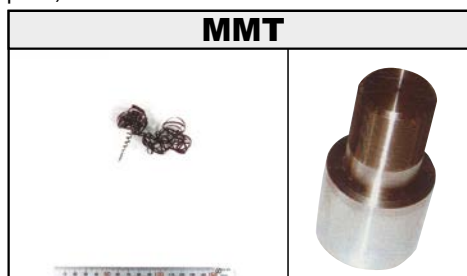
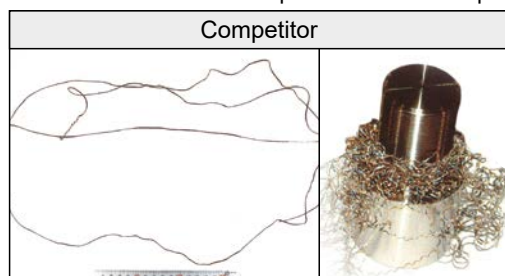

<Cutting Conditions>
 Workpiece : DIN 41CrMo4
 Insert : MMT16ER150ISO-S
 Grade : VP15TF
 Cutting speed : 120m/min
 Cutting method : Radial Infeed
 Depth of cut : Fixed cut area
 Pass : 6 times
 Coolant : Wet

■ A HIGHER LEVEL OF PRECISION THAN CONVENTIONAL INSERTS (G-CLASS GROUND INSERTS)

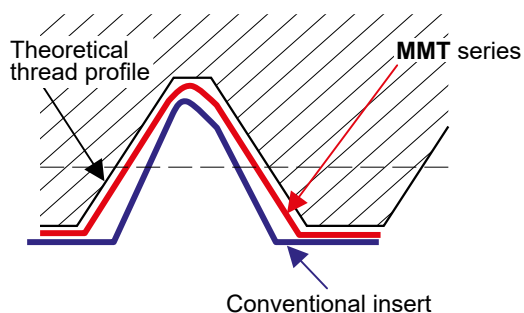

High precision threading can be achieved by using MMT inserts that feature a ground rake faces and peripheral cutting edges.

Thread Type	Threading Tolerance
ISO Metric	6g / 6H
American UN	2A / 2B
Whitworth for BSW, BSP	Medium Class A
BSPT	Standard BSPT
Round DIN 405	7h / 7H
ISO Trapezoidal 30°	7e / 7H
American ACME	3G
UNJ	3A
API Buttress Casing	Standard API
API Rounded Casing & Tubing	Standard API RD
American NPT	Standard NPT
American NPTF	Class2

■ HOLDER (Use of special surface treatment)

External

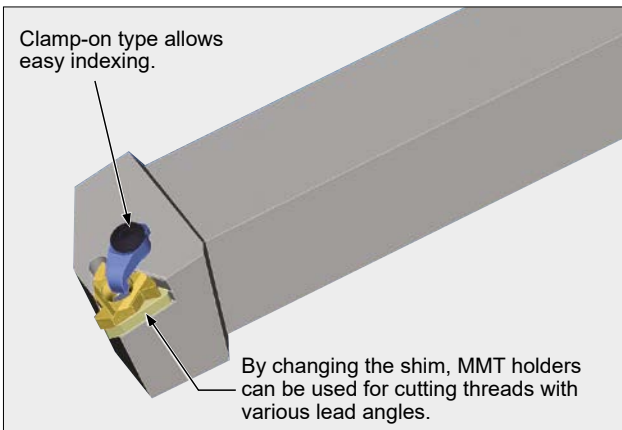

Internal

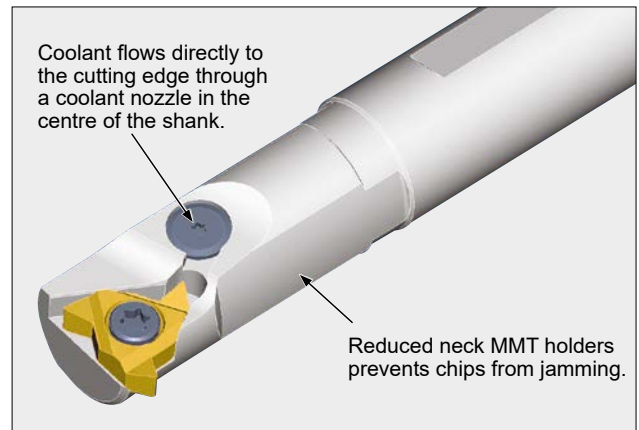

* Order number of coolant guide screw: TFS03006 (Except MMTIR1316/MMTIR1516)

■ SUITABLE FOR THREADING WITH A LARGE LEAD ANGLE

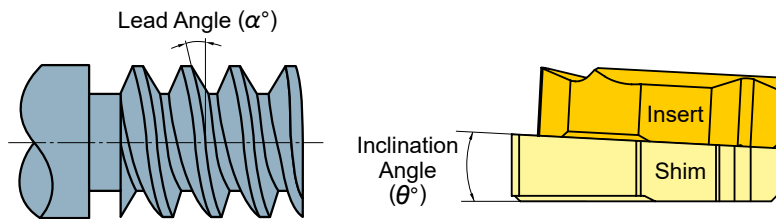

By changing only the shim, MMT holders can be used for turning of threads with various lead angles as well as the turning of left hand threads.

Lead Angle (α°)	Inclination Angle (θ°)
-1.5°	-3°
-0.5°	-2°
0.5°	-1°
1.5°	0°
2.5°	1°
3.5°	2°
4.5°	3°

□ Standard shim delivered with the holder.

■ GRADE

VP10MF (G-class ground inserts only)

● Superior wear and plastic deformation resistance

- High wear and plastic deformation resistance for threading when maintaining the thread form is important. Suitable for continuous high precision machining with extensive tool life.
- Effective in combination with G-class inserts for high precision threading.

VP15TF (G-class ground inserts, M-class inserts with 3-D chipbreakers)

● Wide versatility

- High fracture resistance during low rigidity applications such as bar feed machining. Able to withstand harsh conditions for long periods where conventional inserts would be liable to breakage.
- Effective combination of high cost performance M-class inserts with 3-D chipbreakers.

VP20RT (M-class inserts with 3-D chipbreakers)

● Excellent fracture resistance

- Suitable for stainless steel boring and unstable machining where inserts are vulnerable to fracturing.
- Effective combination of high cost performance M-class inserts with 3-D chipbreakers.

■ CHOOSING M-CLASS INSERTS WITH 3-D CHIPBREAKERS OR G-CLASS INSERTS

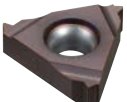
Insert	Chip control	Precision of thread	Insert	Chip control	Precision of thread
M-class inserts with 3-D chipbreakers 	◎	○	G-class inserts 	○	◎

- For ideal chip control and a high cost performance ratio, M-class inserts with 3-D chipbreakers are recommended.
- G-class inserts are recommended where higher precision is required.

CUTTING CONDITIONS OF MMT SERIES

SELECTING A SHIM FOR THE MMT SERIES

FLANK ANGLE AND LEAD ANGLE

Lead angle (α) depends on a combination of thread diameter and pitch. Select a shim so that the lead angle of the thread can coincide with the flank angles of the thread and insert (β_1, β_2). No need to change a shim for general threading with an MMT holder. When threading with a small diameter or large pitch, change the shim depending on the lead angle, referring to the table and graph below. When threading left hand threads, change to a shim with a negative inclination angle.

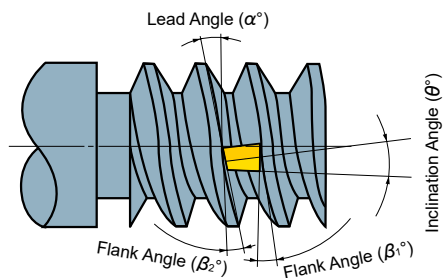

SHIM REFERENCE TABLE (THREADING DIAMETER) (Thread angle 60° and 55°)

Lead Angle	Right Hand Thread (mm)					Left Hand Thread (mm) *			
	Pitch (mm)	Threading impossible	4.5°	3.5°	2.5°	1.5°	0.5°	Threading impossible	-1.5°
0.5	$\leq \phi 1.7$	$\phi 1.7 - \phi 2.3$	$\phi 2.3 - \phi 3.0$	$\phi 3.0 - \phi 4.6$	$\phi 4.6 - \phi 9.1$	$\geq \phi 9.1$	$\leq \phi 3.6$	$\phi 3.6 - \phi 9.1$	$\geq \phi 9.1$
0.75	$\leq \phi 2.5$	$\phi 2.5 - \phi 3.4$	$\phi 3.4 - \phi 4.6$	$\phi 4.6 - \phi 6.8$	$\phi 6.8 - \phi 13.7$	$\geq \phi 13.7$	$\leq \phi 5.5$	$\phi 5.5 - \phi 13.7$	$\geq \phi 13.7$
1	$\leq \phi 3.3$	$\phi 3.3 - \phi 4.6$	$\phi 4.6 - \phi 6.1$	$\phi 6.1 - \phi 9.1$	$\phi 9.1 - \phi 18.2$	$\geq \phi 18.2$	$\leq \phi 7.3$	$\phi 7.3 - \phi 18.2$	$\geq \phi 18.2$
1.25	$\leq \phi 4.1$	$\phi 4.1 - \phi 5.7$	$\phi 5.7 - \phi 7.6$	$\phi 7.6 - \phi 11.4$	$\phi 11.4 - \phi 22.8$	$\geq \phi 22.8$	$\leq \phi 9.1$	$\phi 9.1 - \phi 22.8$	$\geq \phi 22.8$
1.5	$\leq \phi 5.0$	$\phi 5.0 - \phi 6.8$	$\phi 6.8 - \phi 9.1$	$\phi 9.1 - \phi 13.7$	$\phi 13.7 - \phi 27.4$	$\geq \phi 27.4$	$\leq \phi 10.9$	$\phi 10.9 - \phi 27.4$	$\geq \phi 27.4$
1.75	$\leq \phi 5.8$	$\phi 5.8 - \phi 8.0$	$\phi 8.0 - \phi 10.6$	$\phi 10.6 - \phi 16.0$	$\phi 16.0 - \phi 31.9$	$\geq \phi 31.9$	$\leq \phi 12.8$	$\phi 12.8 - \phi 31.9$	$\geq \phi 31.9$
2	$\leq \phi 6.6$	$\phi 6.6 - \phi 9.1$	$\phi 9.1 - \phi 12.1$	$\phi 12.1 - \phi 18.2$	$\phi 18.2 - \phi 36.5$	$\geq \phi 36.5$	$\leq \phi 14.6$	$\phi 14.6 - \phi 36.5$	$\geq \phi 36.5$
2.5	$\leq \phi 8.3$	$\phi 8.3 - \phi 11.4$	$\phi 11.4 - \phi 15.2$	$\phi 15.2 - \phi 22.8$	$\phi 22.8 - \phi 45.6$	$\geq \phi 45.6$	$\leq \phi 18.2$	$\phi 18.2 - \phi 45.6$	$\geq \phi 45.6$
3	$\leq \phi 9.9$	$\phi 9.9 - \phi 13.7$	$\phi 13.7 - \phi 18.2$	$\phi 18.2 - \phi 27.3$	$\phi 27.3 - \phi 54.7$	$\geq \phi 54.7$	$\leq \phi 21.9$	$\phi 21.9 - \phi 54.7$	$\geq \phi 54.7$
3.5	$\leq \phi 11.6$	$\phi 11.6 - \phi 15.9$	$\phi 15.9 - \phi 21.3$	$\phi 21.3 - \phi 31.9$	$\phi 31.9 - \phi 63.8$	$\geq \phi 63.8$	$\leq \phi 25.5$	$\phi 25.5 - \phi 63.8$	$\geq \phi 63.8$
4	$\leq \phi 13.2$	$\phi 13.2 - \phi 18.2$	$\phi 18.2 - \phi 24.3$	$\phi 24.3 - \phi 36.5$	$\phi 36.5 - \phi 72.9$	$\geq \phi 72.9$	$\leq \phi 29.2$	$\phi 29.2 - \phi 72.9$	$\geq \phi 72.9$
4.5	$\leq \phi 14.9$	$\phi 14.9 - \phi 20.5$	$\phi 20.5 - \phi 27.3$	$\phi 27.3 - \phi 41.0$	$\phi 41.0 - \phi 82.1$	$\geq \phi 82.1$	$\leq \phi 32.8$	$\phi 32.8 - \phi 82.1$	$\geq \phi 82.1$
5	$\leq \phi 16.5$	$\phi 16.5 - \phi 22.8$	$\phi 22.8 - \phi 30.4$	$\phi 30.4 - \phi 45.6$	$\phi 45.6 - \phi 91.2$	$\geq \phi 91.2$	$\leq \phi 36.5$	$\phi 36.5 - \phi 91.2$	$\geq \phi 91.2$

* Back turning in the case of left hand threads.

SHIM REFERENCE GRAPH (Thread angle 60° and 55°)

Right Hand Thread

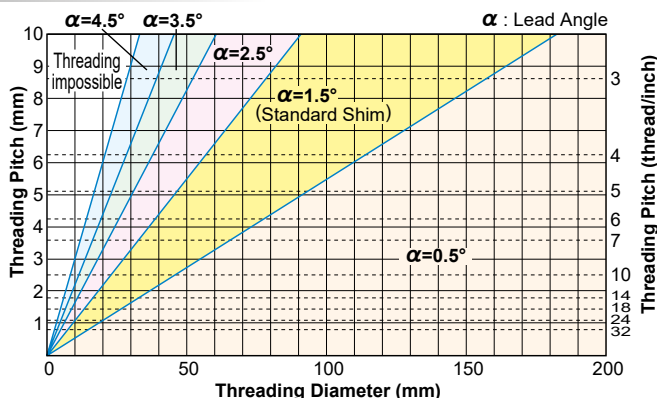

Left Hand Thread

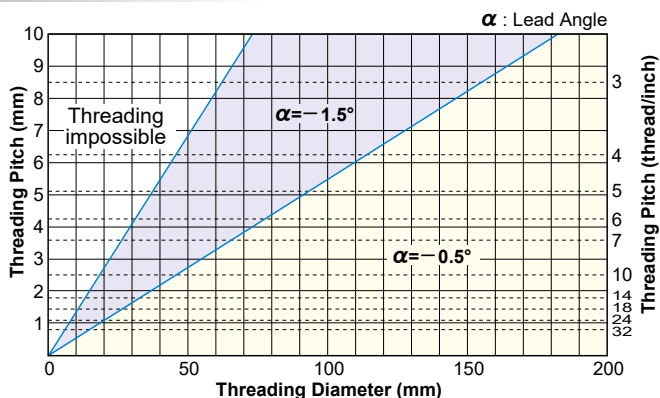

Note 1) When a thread lead angle \leq the tool flank angle, change the shim to prevent side interference with the insert.
(Refer to the table on page G013 for the calculation of thread lead angle and tool flank angle.)

SHIM REFERENCE TABLE (THREADING DIAMETER) (Thread angle 30° and 29°)

Lead Angle	Right Hand Thread (mm)					Left Hand Thread (mm) *			
	Pitch (mm)	Threading impossible	4.5°	3.5°	2.5°	1.5°	0.5°	Threading impossible	-1.5°
0.5	$\leq \phi 1.8$	$\phi 1.8 - \phi 2.3$	$\phi 2.3 - \phi 3.0$	$\phi 3.0 - \phi 4.6$	$\phi 4.6 - \phi 9.1$	$\geq \phi 9.1$	$\leq \phi 4.6$	$\phi 4.6 - \phi 9.1$	$\geq \phi 9.1$
0.75	$\leq \phi 2.7$	$\phi 2.7 - \phi 3.4$	$\phi 3.4 - \phi 4.6$	$\phi 4.6 - \phi 6.8$	$\phi 6.8 - \phi 13.7$	$\geq \phi 13.7$	$\leq \phi 6.8$	$\phi 6.8 - \phi 13.7$	$\geq \phi 13.7$
1	$\leq \phi 3.6$	$\phi 3.6 - \phi 4.6$	$\phi 4.6 - \phi 6.1$	$\phi 6.1 - \phi 9.1$	$\phi 9.1 - \phi 18.2$	$\geq \phi 18.2$	$\leq \phi 9.1$	$\phi 9.1 - \phi 18.2$	$\geq \phi 18.2$
1.25	$\leq \phi 4.5$	$\phi 4.5 - \phi 5.7$	$\phi 5.7 - \phi 7.6$	$\phi 7.6 - \phi 11.4$	$\phi 11.4 - \phi 22.8$	$\geq \phi 22.8$	$\leq \phi 11.4$	$\phi 11.4 - \phi 22.8$	$\geq \phi 22.8$
1.5	$\leq \phi 5.5$	$\phi 5.5 - \phi 6.8$	$\phi 6.8 - \phi 9.1$	$\phi 9.1 - \phi 13.7$	$\phi 13.7 - \phi 27.4$	$\geq \phi 27.4$	$\leq \phi 13.7$	$\phi 13.7 - \phi 27.4$	$\geq \phi 27.4$
1.75	$\leq \phi 6.4$	$\phi 6.4 - \phi 8.0$	$\phi 8.0 - \phi 10.6$	$\phi 10.6 - \phi 16.0$	$\phi 16.0 - \phi 31.9$	$\geq \phi 31.9$	$\leq \phi 16.0$	$\phi 16.0 - \phi 31.9$	$\geq \phi 31.9$
2	$\leq \phi 7.3$	$\phi 7.3 - \phi 9.1$	$\phi 9.1 - \phi 12.1$	$\phi 12.1 - \phi 18.2$	$\phi 18.2 - \phi 36.5$	$\geq \phi 36.5$	$\leq \phi 18.2$	$\phi 18.2 - \phi 36.5$	$\geq \phi 36.5$
2.5	$\leq \phi 9.1$	$\phi 9.1 - \phi 11.4$	$\phi 11.4 - \phi 15.2$	$\phi 15.2 - \phi 22.8$	$\phi 22.8 - \phi 45.6$	$\geq \phi 45.6$	$\leq \phi 22.8$	$\phi 22.8 - \phi 45.6$	$\geq \phi 45.6$
3	$\leq \phi 10.9$	$\phi 10.9 - \phi 13.7$	$\phi 13.7 - \phi 18.2$	$\phi 18.2 - \phi 27.3$	$\phi 27.3 - \phi 54.7$	$\geq \phi 54.7$	$\leq \phi 27.3$	$\phi 27.3 - \phi 54.7$	$\geq \phi 54.7$
3.5	$\leq \phi 12.7$	$\phi 12.7 - \phi 15.9$	$\phi 15.9 - \phi 21.3$	$\phi 21.3 - \phi 31.9$	$\phi 31.9 - \phi 63.8$	$\geq \phi 63.8$	$\leq \phi 31.9$	$\phi 31.9 - \phi 63.8$	$\geq \phi 63.8$
4	$\leq \phi 14.6$	$\phi 14.6 - \phi 18.2$	$\phi 18.2 - \phi 24.3$	$\phi 24.3 - \phi 36.5$	$\phi 36.5 - \phi 72.9$	$\geq \phi 72.9$	$\leq \phi 36.5$	$\phi 36.5 - \phi 72.9$	$\geq \phi 72.9$
4.5	$\leq \phi 16.4$	$\phi 16.4 - \phi 20.5$	$\phi 20.5 - \phi 27.3$	$\phi 27.3 - \phi 41.0$	$\phi 41.0 - \phi 82.1$	$\geq \phi 82.1$	$\leq \phi 41.0$	$\phi 41.0 - \phi 82.1$	$\geq \phi 82.1$
5	$\leq \phi 18.2$	$\phi 18.2 - \phi 22.8$	$\phi 22.8 - \phi 30.4$	$\phi 30.4 - \phi 45.6$	$\phi 45.6 - \phi 91.2$	$\geq \phi 91.2$	$\leq \phi 45.6$	$\phi 45.6 - \phi 91.2$	$\geq \phi 91.2$

* Back turning in the case of left hand threads.

SHIM REFERENCE GRAPH (Thread angle 30° and 29°)

Right Hand Thread

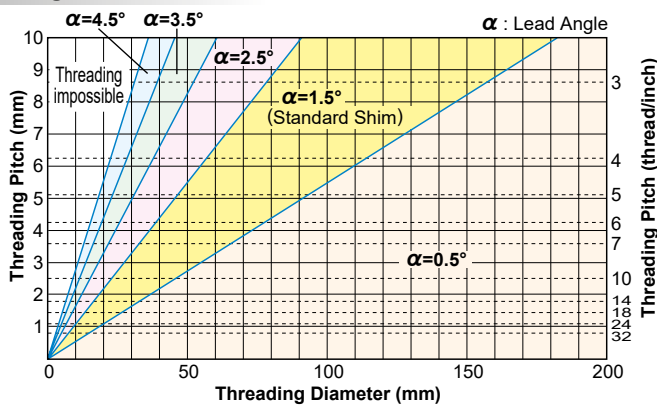

Left Hand Thread

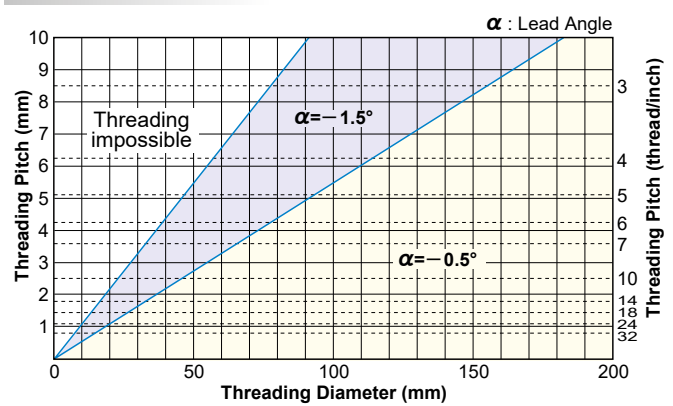

Note 1) When a thread lead angle \leq the tool flank angle, change the shim to prevent side interference with the insert.
(Refer to the table below for the calculation of thread lead angle and tool flank angle.)

SELECTION TABLE

Lead Angle	Opening angle 60°/55° Right Hand Thread		Opening angle 60°/55° Left Hand Thread *		Opening angle 30°/29° Right Hand Thread		Opening angle 30°/29° Left Hand Thread *	
0	P05	P05	N05	N05	P05	P05	N05	N05
0.5	P05	P05	N05	N05	P05	P05	N05	N05
1	P15	P15	N15	N15	P15	P15	N15	N15
1.5	P15	P15	N15	N15	P15	P15	N15	N15
2	P25	P25	N15	N15	P25	P25	Compatible	Compatible
2.5	P25	P25	Compatible	Compatible	P25	P25	Compatible	Compatible
3	P35	P35	Compatible	Compatible	P35	P35	Compatible	Compatible
3.5	P35	P35	Compatible	Compatible	P35	P35	Compatible	Compatible
4	P45	P45	Compatible	Compatible	P45	P45	Compatible	Compatible
4.5	P45	P45	Compatible	Compatible	P45	P45	Compatible	Compatible
5	P45	P45	Compatible	Compatible	Compatible	Compatible	Compatible	Compatible
5.5	Compatible	Compatible	Compatible	Compatible	Compatible	Compatible	Compatible	Compatible

* Back turning in the case of left hand threads.

When replacing a shim, check if the difference between the thread lead angle and shim inclination angle is within:

2.5° – 0.5° where thread helix angle is 60° (55°)

2° – 1° where thread helix angle is 30° (29°)

* Inclination angle of a standard shim is 0°.

* The holder has a 1.5° lead angle.

CALCULATION OF THREAD LEAD ANGLE

$$\tan \alpha = \frac{l}{\pi d} = \frac{nP}{\pi d}$$

α : Lead angle

l : Lead

n : Number of threads

P : Pitch

d : Effective diameter of thread

EXAMPLE OF SELECTING A SHIM

- When the thread lead angle is 2.2°

① In the case when the thread helix angle is 60°

(2.2° lead angle) – (2.5° – 0.5°) = -0.3° – 1.7° shim inclination angle is appropriate.

Threading with a standard shim (0° inclination angle) is possible. But, replacing with a shim with a 1° inclination angle is recommended, refer to the Standard Shim List on pages G019 and G026.

② In the case when the thread helix angle is 30°

(2.2° lead angle) – (2° – 1°) = -0.2° – 1.2° shim inclination angle is appropriate.

Replacing with a shim with a 1° inclination angle is recommended, referring to the Standard Shim List on pages G019 and G026.

RELIEF ANGLE OF AN INSERT SET ON A HOLDER

Thread Helix Angle	Internal Relief Angle	External Relief Angle
60°	8.8°	5.8°
55°	7.9°	5.2°
30°	4.1°	2.7°
29°	4°	2.6°

- Relief angles (β_2 , β_1) of an insert become small when the thread helix angle of a trapezoidal, round, or other thread is small. Take care when selecting a shim.

THREADING

STANDARD OF DEPTH OF CUT EXTERNAL (RADIAL INFEEED)

ISO Metric

Pitch (mm)	Total Cutting Depth	Number of Passes														Insert Type		
		1	2	3	4	5	6	7	8	9	10	11	12	13	14	G-class ground inserts	M-class inserts with 3-D chipbreakers	
0.5	0.31	0.10	0.08	0.07	0.06												MMT16ER050ISO	—
0.75	0.46	0.16	0.14	0.10	0.06												MMT16ER075ISO	—
1.0	0.61	0.18	0.15	0.12	0.10	0.06											MMT16ER100ISO	MMT16ER100ISO-S
1.25	0.77	0.19	0.17	0.14	0.11	0.10	0.06										MMT16ER125ISO	MMT16ER125ISO-S
1.5	0.92	0.22	0.21	0.17	0.14	0.12	0.06										MMT16ER150ISO	MMT16ER150ISO-S
1.75	1.07	0.22	0.21	0.16	0.13	0.11	0.09	0.09	0.06								MMT16ER175ISO	MMT16ER175ISO-S
2.0	1.23	0.24	0.23	0.17	0.16	0.14	0.12	0.11	0.06								MMT16ER200ISO	MMT16ER200ISO-S
2.5	1.53	0.26	0.23	0.19	0.17	0.15	0.13	0.12	0.11	0.11	0.06						MMT16ER250ISO	MMT16ER250ISO-S
3.0	1.84	0.27	0.25	0.20	0.18	0.16	0.14	0.13	0.12	0.12	0.11	0.10	0.06				MMT16ER300ISO	MMT16ER300ISO-S
3.5	2.15	0.33	0.30	0.24	0.21	0.18	0.17	0.15	0.14	0.14	0.12	0.11	0.06				MMT22ER350ISO	—
4.0	2.45	0.34	0.31	0.24	0.22	0.19	0.17	0.16	0.14	0.14	0.13	0.12	0.12	0.11	0.06		MMT22ER400ISO	—
4.5	2.76	0.38	0.34	0.28	0.24	0.22	0.20	0.18	0.16	0.16	0.15	0.14	0.13	0.12	0.06		MMT22ER450ISO	—
5.0	3.07	0.42	0.38	0.32	0.27	0.24	0.22	0.20	0.18	0.18	0.17	0.16	0.15	0.12	0.06		MMT22ER500ISO	—

American UN

Pitch (thread/inch)	Total Cutting Depth	Number of Passes														Insert Type		
		1	2	3	4	5	6	7	8	9	10	11	12	13	14	G-class ground inserts	M-class inserts with 3-D chipbreakers	
32	0.49	0.17	0.15	0.11	0.06												MMT16ER320UN	—
28	0.56	0.17	0.14	0.10	0.09	0.06											MMT16ER280UN	—
24	0.65	0.18	0.16	0.14	0.11	0.06											MMT16ER240UN	—
20	0.78	0.20	0.18	0.13	0.11	0.10	0.06										MMT16ER200UN	—
18	0.87	0.22	0.20	0.15	0.13	0.11	0.06										MMT16ER180UN	—
16	0.97	0.22	0.20	0.15	0.12	0.11	0.11	0.06									MMT16ER160UN	MMT16ER160UN-S
14	1.11	0.23	0.21	0.16	0.13	0.11	0.11	0.10	0.06								MMT16ER140UN	MMT16ER140UN-S
13	1.20	0.25	0.22	0.17	0.14	0.13	0.12	0.11	0.06								MMT16ER130UN	—
12	1.30	0.28	0.23	0.18	0.16	0.14	0.13	0.12	0.06								MMT16ER120UN	MMT16ER120UN-S
11	1.42	0.28	0.23	0.19	0.16	0.14	0.13	0.12	0.11	0.06							MMT16ER110UN	—
10	1.56	0.28	0.24	0.19	0.16	0.14	0.13	0.13	0.12	0.11	0.06						MMT16ER100UN	—
9	1.73	0.34	0.29	0.22	0.17	0.15	0.14	0.13	0.12	0.11	0.06						MMT16ER090UN	—
8	1.95	0.35	0.30	0.24	0.19	0.16	0.15	0.14	0.13	0.12	0.11	0.06					MMT16ER080UN	—
7	2.22	0.37	0.33	0.28	0.24	0.20	0.17	0.16	0.15	0.14	0.12	0.06					MMT22ER070UN	—
6	2.60	0.42	0.35	0.29	0.25	0.21	0.18	0.17	0.16	0.15	0.13	0.12	0.11	0.06			MMT22ER060UN	—
5	3.12	0.43	0.39	0.31	0.27	0.24	0.22	0.20	0.19	0.19	0.18	0.17	0.15	0.12	0.06		MMT22ER050UN	—

Whitworth for BSW, BSP

Pitch (thread/inch)	Total Cutting Depth	Number of Passes														Insert Type		
		1	2	3	4	5	6	7	8	9	10	11	12	13	14	G-class ground inserts	M-class inserts with 3-D chipbreakers	
28	0.58	0.17	0.14	0.11	0.10	0.06											MMT16ER280W	—
26	0.63	0.18	0.15	0.13	0.11	0.06											MMT16ER260W	—
20	0.81	0.20	0.18	0.14	0.12	0.11	0.06										MMT16ER200W	—
19	0.86	0.21	0.19	0.15	0.13	0.12	0.06										MMT16ER190W	MMT16ER190W-S
18	0.90	0.25	0.19	0.15	0.13	0.12	0.06										MMT16ER180W	—
16	1.02	0.21	0.18	0.15	0.13	0.11	0.09	0.09	0.06								MMT16ER160W	—
14	1.16	0.23	0.21	0.17	0.14	0.12	0.12	0.11	0.06								MMT16ER140W	MMT16ER140W-S
12	1.36	0.27	0.25	0.20	0.16	0.15	0.14	0.13	0.06								MMT16ER120W	—
11	1.48	0.27	0.24	0.20	0.17	0.15	0.14	0.13	0.12	0.06							MMT16ER110W	MMT16ER110W-S
10	1.63	0.27	0.25	0.20	0.17	0.15	0.15	0.13	0.13	0.12	0.06						MMT16ER100W	—
9	1.81	0.28	0.26	0.21	0.18	0.16	0.15	0.14	0.13	0.12	0.12	0.06					MMT16ER090W	—
8	2.03	0.30	0.27	0.22	0.19	0.17	0.16	0.15	0.14	0.13	0.12	0.12	0.06				MMT16ER080W	—
7	2.32	0.34	0.32	0.26	0.22	0.20	0.18	0.17	0.16	0.15	0.14	0.12	0.06				MMT22ER070W	—
6	2.71	0.35	0.33	0.27	0.23	0.21	0.20	0.19	0.17	0.16	0.15	0.14	0.13	0.12	0.06		MMT22ER060W	—
5	3.25	0.42	0.40	0.35	0.29	0.26	0.24	0.22	0.20	0.19	0.18	0.17	0.15	0.12	0.06		MMT22ER050W	—

BSPT

Pitch (thread/inch)	Total Cutting Depth	Number of Passes														Insert Type		
		1	2	3	4	5	6	7	8	9						G-class ground inserts	M-class inserts with 3-D chipbreakers	
28	0.58	0.17	0.14	0.11	0.10	0.06											MMT16ER280BSPT	—
19	0.86	0.22	0.19	0.15	0.12	0.12	0.06										MMT16ER190BSPT	MMT16ER190BSPT-S
14	1.16	0.24	0.20	0.17	0.14	0.12	0.12	0.11	0.06								MMT16ER140BSPT	MMT16ER140BSPT-S
11	1.48	0.25	0.23	0.21	0.18	0.16	0.14	0.13	0.12	0.06							MMT16ER110BSPT	MMT16ER110BSPT-S

Note 1) • Set the finishing allowance on a diameter at approx. 0.1mm when using a full form insert.

- Please note the cutting depth and the number of passes when a corner radius of a partial form insert or of an internal threading insert is small to prevent damage to the insert corner.
- Please set the cutting depth sufficiently deep enough on materials such as hardened steel or austenitic stainless steel to help prevent premature wear and chipping caused by the outer layer of the material.

■ Round DIN 405

Pitch (thread/ inch)	Total Cutting Depth	Number of Passes														Insert Type		
		1	2	3	4	5	6	7	8	9	10	11	12	13	14			
10	1.27	0.23	0.21	0.20	0.19	0.16	0.12	0.10	0.06									MMT16ER100RD
8	1.59	0.23	0.21	0.20	0.19	0.18	0.16	0.14	0.12	0.10	0.06							MMT16ER080RD
6	2.12	0.26	0.25	0.24	0.22	0.21	0.19	0.17	0.16	0.14	0.12	0.10	0.06					MMT16ER060RD
4	3.18	0.34	0.33	0.32	0.30	0.28	0.26	0.24	0.22	0.20	0.19	0.17	0.15	0.12	0.06			MMT22ER040RD

■ ISO Trapezoidal 30°

Pitch (mm)	Total Cutting Depth	Number of Passes														Insert Type		
		1	2	3	4	5	6	7	8	9	10	11	12	13	14			
1.5	0.90	0.23	0.21	0.16	0.13	0.11	0.06											MMT16ER150TR
2.0	1.25	0.29	0.26	0.21	0.17	0.14	0.12	0.06										MMT16ER200TR
3.0	1.75	0.32	0.31	0.24	0.19	0.18	0.17	0.15	0.13	0.06								MMT16ER300TR
4.0	2.25	0.33	0.32	0.24	0.22	0.21	0.17	0.16	0.15	0.14	0.13	0.12	0.16					MMT22ER400TR
5.0	2.75	0.35	0.32	0.26	0.24	0.22	0.21	0.19	0.19	0.17	0.15	0.14	0.13	0.12	0.06			MMT22ER500TR

■ American ACME

Pitch (thread/ inch)	Total Cutting Depth	Number of Passes														Insert Type		
		1	2	3	4	5	6	7	8	9	10	11	12	13	14			
12	1.19	0.27	0.23	0.20	0.17	0.14	0.12	0.06										MMT16ER120ACME
10	1.52	0.29	0.25	0.21	0.18	0.16	0.14	0.12	0.11	0.06								MMT16ER100ACME
8	1.84	0.30	0.26	0.22	0.19	0.16	0.15	0.14	0.13	0.12	0.11	0.06						MMT16ER080ACME
6	2.37	0.34	0.30	0.27	0.24	0.21	0.19	0.16	0.14	0.12	0.12	0.11	0.11	0.06				MMT22ER060ACME
5	2.79	0.36	0.33	0.30	0.26	0.23	0.20	0.18	0.17	0.16	0.15	0.14	0.13	0.12	0.06			MMT22ER050ACME

■ UNJ

Pitch (thread/ inch)	Total Cutting Depth	Number of Passes														Insert Type		
		1	2	3	4	5	6	7	8	9	10	11						
32	0.46	0.16	0.14	0.10	0.06													MMT16ER320UNJ
28	0.52	0.16	0.12	0.09	0.09	0.06												MMT16ER280UNJ
24	0.61	0.17	0.14	0.14	0.10	0.06												MMT16ER240UNJ
20	0.73	0.19	0.16	0.13	0.10	0.09	0.06											MMT16ER200UNJ
18	0.81	0.23	0.18	0.14	0.10	0.10	0.06											MMT16ER180UNJ
16	0.92	0.26	0.21	0.14	0.12	0.10	0.09											MMT16ER160UNJ
14	1.05	0.26	0.23	0.17	0.12	0.11	0.10	0.06										MMT16ER140UNJ
12	1.22	0.28	0.27	0.20	0.17	0.13	0.11	0.06										MMT16ER120UNJ
10	1.47	0.30	0.29	0.21	0.15	0.13	0.12	0.11	0.10	0.06								MMT16ER100UNJ
8	1.83	0.31	0.30	0.23	0.18	0.15	0.14	0.13	0.12	0.11	0.10	0.06						MMT16ER080UNJ

■ API Buttress Casing

Pitch (thread/ inch)	Total Cutting Depth	Number of Passes														Insert Type		
		1	2	3	4	5	6	7	8	9	10	11						
5	1.55	0.25	0.23	0.17	0.15	0.13	0.12	0.12	0.11	0.11	0.10	0.06						MMT22ER050APBU

■ API Round Casing&Tubing

Pitch (thread/ inch)	Total Cutting Depth	Number of Passes														Insert Type		
		1	2	3	4	5	6	7	8	9	10	11	12					
10	1.41	0.25	0.23	0.16	0.14	0.12	0.12	0.12	0.11	0.10	0.06							MMT16ER100APRD
8	1.81	0.25	0.24	0.19	0.16	0.14	0.14	0.13	0.13	0.13	0.13	0.13	0.11	0.06				MMT16ER080APRD

■ American NPT

Pitch (thread/ inch)	Total Cutting Depth	Number of Passes															Insert Type	
		1	2	3	4	5	6	7	8	9	10	11	12	13	14	15		
27	0.66	0.15	0.13	0.12	0.11	0.09	0.06											MMT16ER270NPT
18	1.01	0.20	0.16	0.14	0.13	0.12	0.11	0.09	0.06									MMT16ER180NPT
14	1.33	0.23	0.19	0.16	0.14	0.13	0.12	0.11	0.10	0.09	0.06							MMT16ER140NPT
11.5	1.64	0.24	0.19	0.17	0.15	0.15	0.13	0.13	0.12	0.11	0.10	0.09	0.06					MMT16ER115NPT
8	2.42	0.33	0.28	0.23	0.20	0.18	0.16	0.15	0.14	0.13	0.12	0.12	0.11	0.11	0.10	0.06		MMT16ER080NPT

■ American NPTF

Pitch (thread/ inch)	Total Cutting Depth	Number of Passes															Insert Type	
		1	2	3	4	5	6	7	8	9	10	11	12	13	14	15		
27	0.64	0.16	0.14	0.11	0.09	0.08	0.06											MMT16ER270NPTF
18	1.00	0.19	0.16	0.14	0.13	0.12	0.11	0.09	0.06									MMT16ER180NPTF
14	1.35	0.23	0.21	0.16	0.14	0.13	0.12	0.11	0.10	0.09	0.06							MMT16ER140NPTF
11.5	1.63	0.24	0.23	0.19	0.15	0.13	0.11	0.11	0.11	0.10	0.10	0.10	0.06					MMT16ER115NPTF
8	2.38	0.32	0.27	0.23	0.19	0.17	0.16	0.15	0.14	0.13	0.12	0.12	0.11	0.11	0.10	0.06		MMT16ER080NPTF

Note 1) • Set the finishing allowance on a diameter at approx. 0.1mm when using a full form insert.

- Please note the cutting depth and the number of passes when a corner radius of a partial form insert or of an internal threading insert is small to prevent damage to the insert corner.
- Please set the cutting depth sufficiently deep enough on materials such as hardened steel or austenitic stainless steel to help prevent premature wear and chipping caused by the outer layer of the material.

THREADING

STANDARD OF DEPTH OF CUT INTERNAL (RADIAL INFED)

ISO Metric

Pitch (mm)	Total Cutting Depth	Number of Passes														Insert Type			
		1	2	3	4	5	6	7	8	9	10	11	12	13	14	G-class ground inserts		M-class inserts with 3-D chipbreakers	
0.5	0.29	0.09	0.07	0.07	0.06											MMT11R050ISO	MMT16R050ISO	—	—
0.75	0.43	0.15	0.13	0.09	0.06											MMT11R075ISO	MMT16R075ISO	—	—
1.0	0.58	0.17	0.15	0.11	0.09	0.06										MMT11R100ISO	MMT16R100ISO	MMT11R100ISO-S	MMT16R100ISO-S
1.25	0.72	0.18	0.16	0.12	0.11	0.09	0.06									MMT11R125ISO	MMT16R125ISO	MMT11R125ISO-S	MMT16R125ISO-S
1.5	0.87	0.21	0.20	0.16	0.13	0.11	0.06									MMT11R150ISO	MMT16R150ISO	MMT11R150ISO-S	MMT16R150ISO-S
1.75	1.01	0.21	0.20	0.15	0.12	0.10	0.09	0.08	0.06							MMT11R175ISO	MMT16R175ISO	—	MMT16R175ISO-S
2.0	1.15	0.24	0.22	0.18	0.14	0.12	0.10	0.09	0.06							MMT11R200ISO	MMT16R200ISO	—	MMT16R200ISO-S
2.5	1.44	0.25	0.24	0.21	0.15	0.13	0.12	0.10	0.09	0.09	0.06					—	MMT16R250ISO	—	MMT16R250ISO-S
3.0	1.73	0.26	0.25	0.22	0.17	0.14	0.13	0.12	0.11	0.10	0.09	0.08	0.06			—	MMT16R300ISO	—	MMT16R300ISO-S
3.5	2.02	0.32	0.30	0.23	0.19	0.17	0.15	0.14	0.13	0.12	0.11	0.10	0.06			—	MMT22R350ISO	—	—
4.0	2.31	0.33	0.31	0.24	0.22	0.18	0.15	0.14	0.13	0.12	0.12	0.11	0.10	0.10	0.06	—	MMT22R400ISO	—	—
4.5	2.60	0.36	0.33	0.28	0.24	0.21	0.19	0.16	0.15	0.14	0.13	0.12	0.12	0.11	0.06	—	MMT22R450ISO	—	—
5.0	2.89	0.41	0.38	0.32	0.27	0.24	0.21	0.18	0.16	0.15	0.14	0.13	0.12	0.12	0.06	—	MMT22R500ISO	—	—

American UN

Pitch (thread/inch)	Total Cutting Depth	Number of Passes														Insert Type			
		1	2	3	4	5	6	7	8	9	10	11	12	13	14	G-class ground inserts		M-class inserts with 3-D chipbreakers	
32	0.46	0.16	0.14	0.10	0.06											MMT11R320UN	MMT16R320UN	—	—
28	0.52	0.16	0.13	0.09	0.08	0.06										MMT11R280UN	MMT16R280UN	—	—
24	0.61	0.17	0.15	0.13	0.10	0.06										MMT11R240UN	MMT16R240UN	—	—
20	0.73	0.18	0.15	0.13	0.11	0.10	0.06									MMT11R200UN	MMT16R200UN	—	—
18	0.81	0.20	0.18	0.14	0.12	0.11	0.06									MMT11R180UN	MMT16R180UN	—	—
16	0.92	0.20	0.18	0.15	0.12	0.11	0.10	0.06								MMT11R160UN	MMT16R160UN	MMT16R160UN-S	—
14	1.05	0.21	0.18	0.15	0.13	0.11	0.11	0.10	0.06							MMT11R140UN	MMT16R140UN	MMT16R140UN-S	—
13	1.13	0.22	0.19	0.16	0.14	0.13	0.12	0.11	0.06							—	MMT16R130UN	—	—
12	1.22	0.24	0.22	0.18	0.16	0.13	0.12	0.11	0.06							—	MMT16R120UN	MMT16R120UN-S	—
11	1.33	0.24	0.22	0.20	0.15	0.12	0.12	0.11	0.11	0.06						—	MMT16R110UN	—	—
10	1.47	0.25	0.22	0.21	0.14	0.13	0.12	0.12	0.11	0.11	0.06					—	MMT16R100UN	—	—
9	1.63	0.31	0.23	0.21	0.17	0.15	0.14	0.13	0.12	0.11	0.06					—	MMT16R090UN	—	—
8	1.83	0.31	0.26	0.21	0.18	0.16	0.15	0.14	0.13	0.12	0.11	0.06				—	MMT16R080UN	—	—
7	2.09	0.36	0.30	0.24	0.21	0.18	0.17	0.16	0.15	0.14	0.12	0.06				—	MMT22R070UN	—	—
6	2.44	0.40	0.33	0.25	0.23	0.19	0.17	0.16	0.15	0.14	0.13	0.12	0.11	0.06		—	MMT22R060UN	—	—
5	2.93	0.41	0.35	0.31	0.26	0.23	0.21	0.20	0.19	0.17	0.15	0.14	0.13	0.12	0.06	—	MMT22R050UN	—	—

Whitworth for BSW, BSP

Pitch (thread/inch)	Total Cutting Depth	Number of Passes														Insert Type			
		1	2	3	4	5	6	7	8	9	10	11	12	13	14	G-class ground inserts		M-class inserts with 3-D chipbreakers	
28	0.58	0.17	0.14	0.11	0.10	0.06										—	MMT16R280W	—	—
26	0.63	0.18	0.15	0.13	0.11	0.06										—	MMT16R260W	—	—
20	0.81	0.20	0.18	0.14	0.12	0.11	0.06									—	MMT16R200W	—	—
19	0.86	0.21	0.19	0.15	0.13	0.12	0.06									MMT11R190W	MMT16R190W	MMT16R190W-S	—
18	0.90	0.25	0.19	0.15	0.13	0.12	0.06									—	MMT16R180W	—	—
16	1.02	0.21	0.18	0.15	0.13	0.11	0.09	0.09	0.06							—	MMT16R160W	—	—
14	1.16	0.23	0.21	0.17	0.14	0.12	0.12	0.11	0.06							MMT11R140W	MMT16R140W	MMT16R140W-S	—
12	1.36	0.27	0.25	0.20	0.16	0.15	0.14	0.13	0.06							—	MMT16R120W	MMT16R120W-S	—
11	1.48	0.27	0.24	0.20	0.17	0.15	0.14	0.13	0.12	0.06						—	MMT16R110W	—	—
10	1.63	0.27	0.25	0.20	0.17	0.15	0.15	0.13	0.13	0.12	0.06					—	MMT16R100W	—	—
9	1.81	0.28	0.26	0.21	0.18	0.16	0.15	0.14	0.13	0.12	0.12	0.06				—	MMT16R090W	—	—
8	2.03	0.30	0.27	0.22	0.19	0.17	0.16	0.15	0.14	0.13	0.12	0.12	0.06			—	MMT16R080W	—	—
7	2.32	0.34	0.32	0.26	0.22	0.20	0.18	0.17	0.16	0.15	0.14	0.12	0.06			—	MMT22R070W	—	—
6	2.71	0.35	0.33	0.27	0.23	0.21	0.20	0.19	0.17	0.16	0.15	0.14	0.13	0.12	0.06	—	MMT22R060W	—	—
5	3.25	0.42	0.40	0.35	0.29	0.26	0.24	0.22	0.20	0.19	0.18	0.17	0.15	0.12	0.06	—	MMT22R050W	—	—

Note 1) • Set the finishing allowance on a diameter at approx. 0.1mm when using a full form insert.

- Please note the cutting depth and the number of passes when a corner radius of a partial form insert or of an internal threading insert is small to prevent damage to the insert corner.
- Please set the cutting depth sufficiently deep enough on materials such as hardened steel or austenitic stainless steel to help prevent premature wear and chipping caused by the outer layer of the material.

■ BSPT

Pitch (thread/ inch)	Total Cutting Depth	Number of Passes													Insert Type					
		1	2	3	4	5	6	7	8	9								G-class ground inserts	M-class inserts with 3-D chipbreakers	
19	0.86	0.22	0.19	0.15	0.12	0.12	0.06											MMT11R190BSPT	MMT16R190BSPT	MMT16R190BSPT-S
14	1.16	0.24	0.20	0.17	0.14	0.12	0.12	0.11	0.06									MMT11R140BSPT	MMT16R140BSPT	MMT16R140BSPT-S
11	1.48	0.25	0.23	0.21	0.18	0.16	0.14	0.13	0.12	0.06								—	MMT16R110BSPT	MMT16R110BSPT-S

■ Round DIN 405

Pitch (thread/ inch)	Total Cutting Depth	Number of Passes														Insert Type				
		1	2	3	4	5	6	7	8	9	10	11	12	13	14					
10	1.27	0.23	0.21	0.20	0.19	0.16	0.12	0.10	0.06											MMT16R100RD
8	1.59	0.23	0.21	0.20	0.19	0.18	0.16	0.14	0.12	0.10	0.06									MMT16R080RD
6	2.12	0.26	0.25	0.24	0.22	0.21	0.19	0.17	0.16	0.14	0.12	0.10	0.06							MMT16R060RD
4	3.18	0.34	0.33	0.32	0.30	0.28	0.26	0.24	0.22	0.20	0.19	0.17	0.15	0.12	0.06					MMT22R040RD

■ ISO Trapezoidal 30°

Pitch (mm)	Total Cutting Depth	Number of Passes														Insert Type				
		1	2	3	4	5	6	7	8	9	10	11	12	13	14					
1.5	0.90	0.23	0.21	0.16	0.13	0.11	0.06													MMT16R150TR
2	1.25	0.29	0.26	0.21	0.17	0.14	0.12	0.06												MMT16R200TR
3	1.75	0.32	0.31	0.24	0.19	0.18	0.17	0.15	0.13	0.06										MMT16R300TR
4	2.25	0.33	0.32	0.24	0.22	0.21	0.17	0.16	0.15	0.14	0.13	0.12	0.06							MMT22R400TR
5	2.75	0.35	0.32	0.26	0.24	0.22	0.21	0.19	0.19	0.17	0.15	0.14	0.13	0.12	0.06					MMT22R500TR

■ American ACME

Pitch (thread/ inch)	Total Cutting Depth	Number of Passes														Insert Type				
		1	2	3	4	5	6	7	8	9	10	11	12	13	14					
12	1.19	0.27	0.23	0.20	0.17	0.14	0.12	0.06												MMT16R120ACME
10	1.52	0.29	0.25	0.21	0.18	0.16	0.14	0.12	0.11	0.06										MMT16R100ACME
8	1.84	0.30	0.26	0.22	0.19	0.16	0.15	0.14	0.13	0.12	0.11	0.06								MMT16R080ACME
6	2.37	0.34	0.30	0.27	0.24	0.21	0.19	0.16	0.14	0.12	0.12	0.11	0.11	0.06						MMT22R060ACME
5	2.79	0.36	0.33	0.30	0.26	0.23	0.20	0.18	0.17	0.16	0.15	0.14	0.13	0.12	0.06					MMT22R050ACME

■ API Buttress Casing

Pitch (thread/ inch)	Total Cutting Depth	Number of Passes														Insert Type				
		1	2	3	4	5	6	7	8	9	10	11								
5	1.55	0.25	0.23	0.17	0.15	0.13	0.12	0.12	0.11	0.11	0.10	0.06								MMT22R050APBU

■ API Round Casing&Tubing

Pitch (thread/ inch)	Total Cutting Depth	Number of Passes												Insert Type						
		1	2	3	4	5	6	7	8	9	10	11	12							
10	1.41	0.25	0.23	0.16	0.14	0.12	0.12	0.12	0.11	0.10	0.06									MMT16R100APRD
8	1.81	0.25	0.24	0.19	0.16	0.14	0.14	0.13	0.13	0.13	0.13	0.11	0.06							MMT16R080APRD

■ American NPT

Pitch (thread/ inch)	Total Cutting Depth	Number of Passes															Insert Type			
		1	2	3	4	5	6	7	8	9	10	11	12	13	14	15				
27	0.66	0.15	0.13	0.12	0.11	0.09	0.06													MMT16R270NPT
18	1.01	0.20	0.16	0.14	0.13	0.12	0.11	0.09	0.06											MMT16R180NPT
14	1.33	0.23	0.19	0.16	0.14	0.13	0.12	0.11	0.10	0.09	0.06									MMT16R140NPT
11.5	1.64	0.24	0.19	0.17	0.15	0.15	0.13	0.13	0.12	0.11	0.10	0.09	0.06							MMT16R115NPT
8	2.42	0.33	0.28	0.23	0.20	0.18	0.16	0.15	0.14	0.13	0.12	0.12	0.11	0.11	0.10	0.06				MMT16R080NPT

■ American NPTF

Pitch (thread/ inch)	Total Cutting Depth	Number of Passes															Insert Type			
		1	2	3	4	5	6	7	8	9	10	11	12	13	14	15				
14	1.35	0.23	0.21	0.16	0.14	0.13	0.12	0.11	0.10	0.09	0.06									MMT16R140NPTF
11.5	1.63	0.24	0.23	0.19	0.15	0.13	0.11	0.11	0.11	0.10	0.10	0.10	0.06							MMT16R115NPTF
8	2.38	0.32	0.27	0.23	0.19	0.17	0.16	0.15	0.14	0.13	0.12	0.12	0.11	0.11	0.10	0.06				MMT16R080NPTF

Note 1) • Set the finishing allowance on a diameter at approx. 0.1mm when using a full form insert.

- Please note the cutting depth and the number of passes when a corner radius of a partial form insert or of an internal threading insert is small to prevent damage to the insert corner.
- Please set the cutting depth sufficiently deep enough on materials such as hardened steel or austenitic stainless steel to help prevent premature wear and chipping caused by the outer layer of the material.

MMT SERIES ORDER NUMBER

HOLDERS

EXTERNAL

MMT E R 12 12 H 16 - C

Designation	Application	Tool Size (mm) (Height and Width)		Tool Length (mm)		Insert Size (mm)		Method of Holding
E	External	12	12	H	100	16	9.525	C
	Hand of Tool	16	16	K	125	22	12.7	
	R	20	20	M	150			
		25	25	P	170			
		32	32					

INTERNAL

MMT I R 13 16 A K 11 - S P15

Designation	Application	Min. Cutting Diameter (mm)	Tool Length (mm)				Insert Size (mm)		Lead Angle	
I	Internal	13	K	125	R	200	11	6.35	P15	1.5°
	Hand of Tool	Shank Diameter (mm)	M	150	S	250	16	9.525	P25	2.5°
	R	A	Q	180	T	300	22	12.7	P35	3.5°
		Shank Material							Holding Method	
		Steel Shank with Coolant Hole							S	Screw-on
									C	Clamp-on

G

THREADING

INSERTS

M-CLASS

MMT 16 E R 100 ISO - S

Designation	Diameter of Incribed Circle (mm)	Application	Hand of Tool	Pitch		Threading Type
16	9.525	E	R	100	1.0mm	S
		I		125	1.25mm	60
				150	1.5mm	55
				175	1.75mm	ISO
				200	2.0mm	W
				250	2.5mm	BSPT
				300	3.0mm	UN

G-CLASS

MMT 16 E R 050 ISO

Designation	Diameter of Incribed Circle (mm)	Application	Hand of Tool	Pitch		Threading Type
16	9.525	E	R	050	0.5mm	60
		I		075	0.75mm	55
				100	1.0mm	ISO
				125	1.25mm	W
				150	1.5mm	BSPT
				175	1.75mm	UN
				200	2.0mm	RD
				250	2.5mm	TR
				300	3.0mm	ACME
				350	3.5mm	UNJ
				400	4.0mm	APBU
				450	4.5mm	APRD
				500	5.0mm	NPT
						NPTF

EXTERNAL THREADING

MMTE HOLDER

- Various insert types.
- Precision class insert.
- Available with a wiper cutting edge to provide a precise thread geometry.
- Able to change lead angle by replacing the shim.

MMTE

External threading

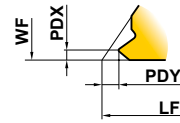
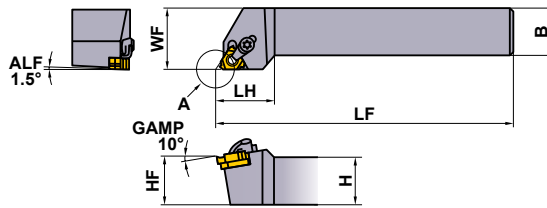
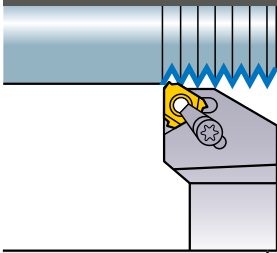

Details of position A
Refer to page G020—G023,
for size PDX, PDY.

Right hand tool holder only.

Order Number	Stock R	Insert Number	Dimensions (mm)						Clamp Bridge	Clamp Screw *	Stop Ring	Shim Screw *	Shim	Wrench
			H	B	LF	LH	HF	WF						
MMTER1212H16-C	●	MMT16ER ○○○○○	12	12	100	25	12	16	SETK51	SETS51	CR4	HFC03008	CTE32TP15	①TKY15F ②HKY20R
MMTER1616H16-C	●		16	16	100	25	16	20	SETK51	SETS51	CR4	HFC03008	CTE32TP15	①TKY15F ②HKY20R
MMTER2020K16-C	●		20	20	125	26	20	25	SETK51	SETS51	CR4	HFC03008	CTE32TP15	①TKY15F ②HKY20R
MMTER2525M16-C	●		25	25	150	28	25	32	SETK51	SETS51	CR4	HFC03008	CTE32TP15	①TKY15F ②HKY20R
MMTER3232P16-C	●		32	32	170	32	32	40	SETK51	SETS51	CR4	HFC03008	CTE32TP15	①TKY15F ②HKY20R
MMTER2525M22-C	●	MMT22ER ○○○○○	25	25	150	32	25	32	SETK61	SETS61	CR5	HFC04010	CTE43TP15	①TKY20F ②HKY25R
MMTER3232P22-C	●		32	32	170	32	32	40	SETK61	SETS61	CR5	HFC04010	CTE43TP15	①TKY20F ②HKY25R

Note 1) Select and use a shim as shown below (sold separately), dependant on the lead angle.

* Clamp Torque (N • m) : SETS51=3.5, SETS61=5.0, HFC03008=1.5, HFC04010=2.2

SHIM

Lead Angle (α°)	Order Number	Stock R	Inclination Angle (θ°)	Applicable Holder
-1.5°	CTE32TN15	●	-3°	MMTER ○○○○○ 16-C
-0.5°	CTE32TN05	●	-2°	
0.5°	CTE32TP05	●	-1°	
1.5°	CTE32TP15	●	0°	
2.5°	CTE32TP25	●	1°	
3.5°	CTE32TP35	●	2°	
4.5°	CTE32TP45	●	3°	

Standard shim delivered with the holder.

Lead Angle (α°)	Order Number	Stock R	Inclination Angle (θ°)	Applicable Holder
-1.5°	CTE43TN15	●	-3°	MMTER ○○○○○ 22-C
-0.5°	CTE43TN05	●	-2°	
0.5°	CTE43TP05	●	-1°	
1.5°	CTE43TP15	●	0°	
2.5°	CTE43TP25	●	1°	
3.5°	CTE43TP35	●	2°	
4.5°	CTE43TP45	●	3°	

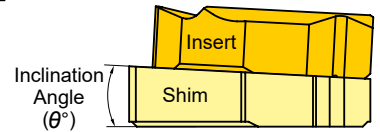

G

THREADING

RECOMMENDED CUTTING CONDITIONS

	Work Material	Hardness	Grade	Cutting Speed (m/min)
P	Mild Steel	≤180HB	VP10MF	150 (70—230)
			VP15TF	100 (60—140)
			VP20RT	80 (60—100)
M	Carbon Steel Alloy Steel	180—280HB	VP10MF	140 (80—200)
			VP15TF	100 (60—140)
			VP20RT	80 (60—100)
M	Stainless Steel	≤200HB	VP15TF VP20RT	80 (40—120)
K	Gray Cast Iron	Tensile Strength ≤350MPa	VP10MF	140 (80—200)
			VP15TF	90 (60—120)

● : Inventory maintained.

	Work Material	Hardness	Grade	Cutting Speed (m/min)
S	Heat-Resistant Alloy	—	VP10MF	45 (15—70)
			VP15TF	30 (20—40)
			VP20RT	
H	Titanium Alloy	—	VP10MF	60 (40—80)
			VP15TF	45 (25—65)
			VP20RT	
H	Heat-Treated Alloy	45—55HRC	VP10MF VP15TF	50 (30—70) 40 (20—60)

HOW TO SELECT A SHIM > G012
SPARE PARTS > N001
TECHNICAL DATA > P001

G019

EXTERNAL THREADING

MMT M-CLASS INSERTS WITH 3-D CHIPBREAKERS

INSERTS

Type	Order Number	Coated		Pitch		Dimensions (mm)					Total Cutting Depth (mm)	Geometry
		VP15TF	VP20RT	mm	thread/inch	IC	S	PDY	PDX	RE		
Partial Profile 60°	MMT16ERA60-S	●		0.5–1.5	48–16	9.525	3.44	0.8	0.9	0.06	—	
	MMT16ERG60-S	●		1.75–3.0	14–8	9.525	3.44	1.2	1.7	0.23	—	
Partial Profile 55°	MMT16ERA55-S	●			48–16	9.525	3.44	0.8	0.9	0.07	—	
	MMT16ERG55-S	●			14–8	9.525	3.44	1.2	1.7	0.23	—	
ISO Metric	MMT16ER100ISO-S	●	●	1.0		9.525	3.44	0.7	0.7	0.13	0.61	
	MMT16ER125ISO-S	●	●	1.25		9.525	3.44	0.8	0.9	0.16	0.77	
	MMT16ER150ISO-S	●	●	1.5		9.525	3.44	0.8	1.0	0.20	0.92	
	MMT16ER175ISO-S	●	●	1.75		9.525	3.44	0.9	1.2	0.22	1.07	
	MMT16ER200ISO-S	●	●	2.0		9.525	3.44	1.0	1.3	0.26	1.23	
	MMT16ER250ISO-S	●	●	2.5		9.525	3.44	1.1	1.5	0.33	1.53	
	MMT16ER300ISO-S	●	●	3.0		9.525	3.44	1.2	1.6	0.40	1.84	
American UN	MMT16ER160UN-S	●			16	9.525	3.44	0.9	1.1	0.23	0.97	
	MMT16ER140UN-S	●			14	9.525	3.44	1.0	1.2	0.26	1.11	
	MMT16ER120UN-S	●			12	9.525	3.44	1.1	1.4	0.30	1.30	
Whitworth for BSW, BSP	MMT16ER190W-S	●			19	9.525	3.44	0.8	1.0	0.18	0.86	
	MMT16ER140W-S	●			14	9.525	3.44	1.0	1.2	0.25	1.16	
	MMT16ER110W-S	●			11	9.525	3.44	1.1	1.5	0.32	1.48	
BSPT	MMT16ER190BSPT-S	●			19	9.525	3.44	0.8	0.9	0.18	0.86	
	MMT16ER140BSPT-S	●			14	9.525	3.44	1.0	1.2	0.25	1.16	
	MMT16ER110BSPT-S	●			11	9.525	3.44	1.1	1.5	0.32	1.48	

G
THREADING

IDENTIFICATION

MMT	16	E	R	100	ISO	-	S	M-class inserts with 3-D chipbreakers
Designation	Diameter of Inscribed Circle (mm)	Application	Hand of Tool	Pitch		Threading Type		
	11 6.35 16 9.525	E External I Internal	R Right	100 1.0mm 125 1.25mm 150 1.5mm 175 1.75mm 200 2.0mm 250 2.5mm 300 3.0mm	A 0.5–1.5mm or 48–16 thread/inch G 1.75–3.0mm or 14–8 thread/inch	60 Partial Profile 60° 55 Partial Profile 55° ISO ISO Metric W Whitworth for BSW, BSP BSPT BSPT UN American UN		

● : Inventory maintained.
(5 inserts in one case)

MMT G-CLASS GROUND INSERTS

INSERTS

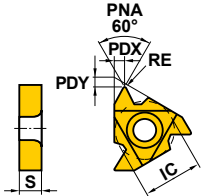
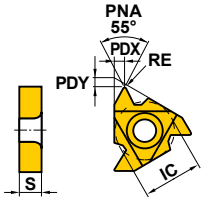
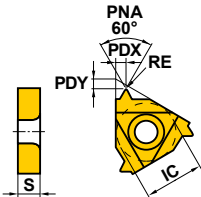
Type	Thread Tolerance	Order Number	Coated		Pitch		Dimensions (mm)					Total Cutting Depth (mm)	Geometry											
			VP10MF	VP15TF	mm	thread/inch	IC	S	PDY	PDX	RE													
Partial Profile 60°	—	MMT16ERA60	●	●	0.5—1.5	48—16	9.525	3.44	0.8	0.9	0.05	—	Partial form 											
		MMT16ERG60	●	●	1.75—3.0	14—8	9.525	3.44	1.2	1.7	0.27													
		MMT16ERAG60	●	●	0.5—3.0	48—8	9.525	3.44	1.2	1.7	0.08													
		MMT22ERN60	●	●	3.5—5.0	7—5	12.7	4.64	1.7	2.5	0.53													
Partial Profile 55°	—	MMT16ERA55	●	●		48—16	9.525	3.44	0.8	0.9	0.05	—	Partial form 											
		MMT16ERG55	●	●		14—8	9.525	3.44	1.2	1.7	0.21													
		MMT16ERAG55	●	●		48—8	9.525	3.44	1.2	1.7	0.07													
		MMT22ERN55	●	●		7—5	12.7	4.64	1.7	2.5	0.44													
ISO Metric 6g	—	MMT16ER050ISO	●	●	0.5		9.525	3.44	0.6	0.4	0.06	0.31	Full form 											
		MMT16ER075ISO	●	●	0.75		9.525	3.44	0.6	0.6	0.10			0.46										
		MMT16ER100ISO	●	●	1.0		9.525	3.44	0.7	0.7	0.16				0.61									
		MMT16ER125ISO	●	●	1.25		9.525	3.44	0.8	0.9	0.19					0.77								
		MMT16ER150ISO	●	●	1.5		9.525	3.44	0.8	1.0	0.23						0.92							
		MMT16ER175ISO	●	●	1.75		9.525	3.44	0.9	1.2	0.21							1.07						
		MMT16ER200ISO	●	●	2.0		9.525	3.44	1.0	1.3	0.31								1.23					
		MMT16ER250ISO	●	●	2.5		9.525	3.44	1.1	1.5	0.32									1.53				
		MMT16ER300ISO	●	●	3.0		9.525	3.44	1.2	1.6	0.46										1.84			
		MMT22ER350ISO	●	●	3.5		12.7	4.64	1.6	2.3	0.45											2.15		
		MMT22ER400ISO	●	●	4.0		12.7	4.64	1.6	2.3	0.52												2.45	
		MMT22ER450ISO	●	●	4.5		12.7	4.64	1.7	2.4	0.58													2.76
		MMT22ER500ISO	●	●	5.0		12.7	4.64	1.7	2.5	0.63													

G

THREADING

IDENTIFICATION

MMT	16	E	R	050	ISO
Designation	Diameter of Inscribed Circle (mm)	Application	Hand of Tool	Pitch	Threading Type
	11 6.35	E External	R Right	050 0.5mm	60 Partial Profile 60°
	16 9.525	I Internal		075 0.75mm	55 Partial Profile 55°
	22 12.7			100 1.0mm	ISO ISO Metric
				125 1.25mm	W Whitworth for BSW, BSP
				150 1.5mm	BSPT BSPT
				175 1.75mm	UN American UN
				200 2.0mm	RD Round DIN 405
				250 2.5mm	TR ISO Trapezoidal 30°
				300 3.0mm	ACME American ACME
				350 3.5mm	UNJ UNJ
				400 4.0mm	APBU API Buttress Casing
				450 4.5mm	APRD API Round Casing & Tubing
				500 5.0mm	NPT NPT
					NPTF NPTF

MMT G-CLASS GROUND INSERTS

INSERTS

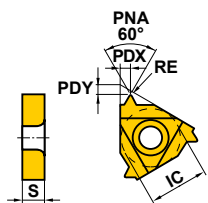
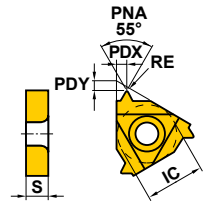
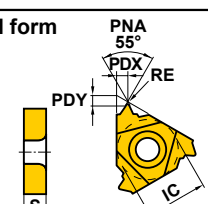
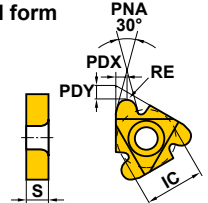
Type	Thread Tolerance	Order Number	Coated		Pitch		Dimensions (mm)					Total Cutting Depth (mm)	Geometry
			VP10MF	VP15TF	mm	thread/inch	IC	S	PDY	PDX	RE		
American UN	2A	MMT16ER320UN	●			32	9.525	3.44	0.6	0.6	0.09	0.49	Full form 
		MMT16ER280UN	●			28	9.525	3.44	0.6	0.7	0.10	0.56	
		MMT16ER240UN	●			24	9.525	3.44	0.7	0.8	0.16	0.65	
		MMT16ER200UN	●			20	9.525	3.44	0.8	0.9	0.19	0.78	
		MMT16ER180UN	●			18	9.525	3.44	0.8	1.0	0.21	0.87	
		MMT16ER160UN	●	●		16	9.525	3.44	0.9	1.1	0.24	0.97	
		MMT16ER140UN	●	●		14	9.525	3.44	1.0	1.2	0.22	1.11	
		MMT16ER130UN	★			13	9.525	3.44	1.0	1.3	0.24	1.20	
		MMT16ER120UN	●	●		12	9.525	3.44	1.1	1.4	0.32	1.30	
		MMT16ER110UN	★			11	9.525	3.44	1.1	1.5	0.29	1.42	
		MMT16ER100UN	●			10	9.525	3.44	1.1	1.5	0.32	1.56	
		MMT16ER090UN	★			9	9.525	3.44	1.2	1.7	0.35	1.73	
		MMT16ER080UN	●			8	9.525	3.44	1.2	1.6	0.48	1.95	
		MMT22ER070UN	●			7	12.7	4.64	1.6	2.3	0.47	2.22	
		MMT22ER060UN	●			6	12.7	4.64	1.6	2.3	0.53	2.60	
MMT22ER050UN	●			5	12.7	4.64	1.7	2.5	0.64	3.12			
Whitworth for BSW, BSP	Medium Class A	MMT16ER280W	●			28	9.525	3.44	0.6	0.7	0.09	0.58	Full form 
		MMT16ER260W	●			26	9.525	3.44	0.7	0.8	0.10	0.63	
		MMT16ER200W	●			20	9.525	3.44	0.8	0.9	0.18	0.81	
		MMT16ER190W	●	●		19	9.525	3.44	0.8	1.0	0.19	0.86	
		MMT16ER180W	●			18	9.525	3.44	0.8	1.0	0.20	0.90	
		MMT16ER160W	●			16	9.525	3.44	0.9	1.1	0.23	1.02	
		MMT16ER140W	●	●		14	9.525	3.44	1.0	1.2	0.26	1.16	
		MMT16ER120W	★			12	9.525	3.44	1.1	1.4	0.30	1.36	
		MMT16ER110W	●	●		11	9.525	3.44	1.1	1.5	0.33	1.48	
		MMT16ER100W	★			10	9.525	3.44	1.1	1.5	0.37	1.63	
		MMT16ER090W	★			9	9.525	3.44	1.2	1.7	0.34	1.81	
		MMT16ER080W	●			8	9.525	3.44	1.2	1.5	0.39	2.03	
		MMT22ER070W	●			7	12.7	4.64	1.6	2.3	0.46	2.32	
		MMT22ER060W	●			6	12.7	4.64	1.6	2.3	0.53	2.71	
MMT22ER050W	●			5	12.7	4.64	1.7	2.4	0.66	3.25			
BSPT	Standard BSPT	MMT16ER280BSPT	●			28	9.525	3.44	0.6	0.6	0.09	0.58	Full form 
		MMT16ER190BSPT	●	●		19	9.525	3.44	0.8	0.9	0.14	0.86	
		MMT16ER140BSPT	●	●		14	9.525	3.44	1.0	1.2	0.26	1.16	
		MMT16ER110BSPT	●	●		11	9.525	3.44	1.1	1.5	0.33	1.48	
Round DIN 405	7h	MMT16ER100RD	●			10	9.525	3.44	1.1	1.2	0.60	1.27	Full form 
		MMT16ER080RD	●			8	9.525	3.44	1.4	1.3	0.75	1.59	
		MMT16ER060RD	●			6	9.525	3.44	1.5	1.7	1.00	2.12	
		MMT22ER040RD	●			4	9.525	3.44	2.2	2.3	1.51	3.18	

G
THREADING

● : Inventory maintained. ★ : Inventory maintained in Japan.
(5 inserts in one case)

INSERTS

Type	Thread Tolerance	Order Number	Coated VP10MF	Pitch		Dimensions (mm)					Total Cutting Depth (mm)	Geometry
				mm	thread/inch	IC	S	PDY	PDX	RE		
ISO Trapezoidal 30°	7e	MMT16ER150TR	●	1.5		9.525	3.44	1.0	1.1	0.08	0.90	
		MMT16ER200TR	●	2.0		9.525	3.44	1.1	1.3	0.15	1.25	
		MMT16ER300TR	●	3.0		9.525	3.44	1.3	1.5	0.15	1.75	
		MMT22ER400TR	●	4.0		12.7	4.64	1.7	1.9	0.15	2.25	
		MMT22ER500TR	●	5.0		12.7	4.64	2.1	2.5	0.15	2.75	
American ACME	3G	MMT16ER120ACME	●		12	9.525	3.44	1.1	1.2	0.08	1.19	
		MMT16ER100ACME	●		10	9.525	3.44	1.3	1.4	0.08	1.52	
		MMT16ER080ACME	●		8	9.525	3.44	1.4	1.5	0.10	1.84	
		MMT22ER060ACME	●		6	12.7	4.64	1.8	2.1	0.10	2.37	
		MMT22ER050ACME	●		5	12.7	4.64	2.0	2.3	0.10	2.79	
UNJ	3A	MMT16ER320UNJ	●		32	9.525	3.44	0.6	0.7	0.13	0.46	
		MMT16ER280UNJ	●		28	9.525	3.44	0.7	0.7	0.14	0.52	
		MMT16ER240UNJ	●		24	9.525	3.44	0.7	0.8	0.17	0.61	
		MMT16ER200UNJ	●		20	9.525	3.44	0.8	0.9	0.20	0.73	
		MMT16ER180UNJ	●		18	9.525	3.44	0.8	1.0	0.22	0.81	
		MMT16ER160UNJ	●		16	9.525	3.44	0.9	1.1	0.25	0.92	
		MMT16ER140UNJ	●		14	9.525	3.44	1.0	1.2	0.29	1.05	
		MMT16ER120UNJ	●		12	9.525	3.44	1.1	1.3	0.33	1.22	
		MMT16ER100UNJ	★		10	9.525	3.44	1.2	1.5	0.40	1.47	
		MMT16ER080UNJ	★		8	9.525	3.44	1.2	1.6	0.51	1.83	
API Buttress Casing	Standard API	MMT22ER050APBU	★		5	12.7	4.64	3.1	1.9	0.18	1.55	
API Round Casing & Tubing	Standard API RD	MMT16ER100APRD	●		10	9.525	3.44	1.2	1.4	0.34	1.41	
		MMT16ER080APRD	●		8	9.525	3.44	1.3	1.5	0.41	1.81	
American NPT	Standard NPT	MMT16ER270NPT	★		27	9.525	3.44	0.7	0.8	0.04	0.66	
		MMT16ER180NPT	●		18	9.525	3.44	0.8	1.0	0.08	1.01	
		MMT16ER140NPT	●		14	9.525	3.44	0.9	1.2	0.09	1.33	
		MMT16ER115NPT	●		11.5	9.525	3.44	1.1	1.5	0.11	1.64	
		MMT16ER080NPT	●		8	9.525	3.44	1.3	1.8	0.14	2.42	
American NPTF	Class 2	MMT16ER270NPTF	★		27	9.525	3.44	0.7	0.8	0.04	0.64	
		MMT16ER180NPTF	●		18	9.525	3.44	0.8	1.0	0.04	1.00	
		MMT16ER140NPTF	●		14	9.525	3.44	0.9	1.2	0.04	1.35	
		MMT16ER115NPTF	●		11.5	9.525	3.44	1.1	1.5	0.04	1.63	
		MMT16ER080NPTF	●		8	9.525	3.44	1.3	1.8	0.04	2.38	

G

THREADING

EXTERNAL THREADING

MT HOLDER

- Clamp-on type.
- Positive insert suffers from negligible chattering and thus produces good finished surfaces.
- Thread pitch $\leq 4.5\text{mm}$.

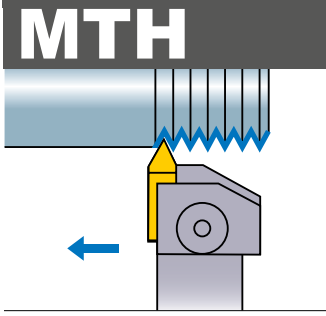

External threading

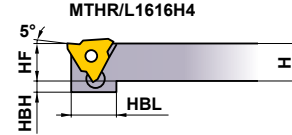
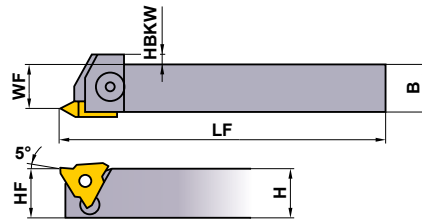

Note 1) Cutting in the opposite direction is not possible.

Right hand tool holder shown.

Order Number	Stock		Insert Number	Dimensions (mm)							Clamp Bridge	Clamp Screw *	Spring	Wrench	
	R	L		H	B	LF	HF	WF	HBKW	HBH					HBL
MTHR/L1616H4	★	★	MTTR/L43○○○○	16	16	100	16	13.8	3	3	21	MTK1R/L	HBH06020	MES3	HKY40R
MTHR/L2020K4	●	★		20	20	125	20	17.8	—	—	—	MTK1R/L	HBH06020	MES3	HKY40R
MTHR/L2525M4	●	★		25	25	150	25	22.8	—	—	—	MTK1R/L	HBH06020	MES3	HKY40R

* Clamp Torque (N · m) : HBH06020=7.0

MT1

External threading

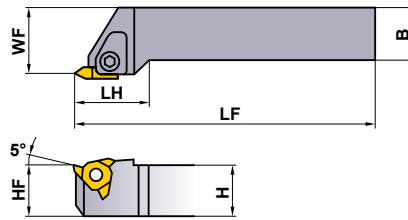
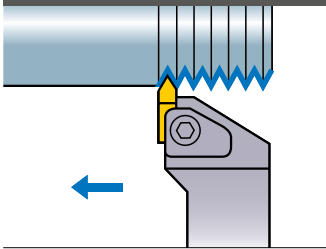

Note 1) Cutting in the opposite direction is not possible.

Right hand tool holder shown.

Order Number	Stock		Insert Number	Dimensions (mm)							Clamp Bridge	Clamp Screw *	Spring	Wrench
	R	L		H	B	LF	LH	HF	WF					
MT1R/L2020K4	★	★	MTTR/L43○○○○	20	20	125	30	20	25	MTK1R/L	HBH06020	MES3	HKY40R	
MT1R/L2525M4	★	★		25	25	150	30	25	32	MTK1R/L	HBH06020	MES3	HKY40R	
MT1R/L3232P4	★	★		32	32	170	30	32	40	MTK1R/L	HBH06020	MES3	HKY40R	

* Clamp Torque (N · m) : HBH06020=7.0

RECOMMENDED CUTTING CONDITIONS

Work Material	Hardness	Grade	Cutting Speed (m/min)
P Mild Steel	$\leq 180\text{HB}$	UP20M	140 (100–180)
		NX2525	200 (150–250)
		UTi20T	120 (100–150)
Carbon Steel Alloy Steel	180–280HB	UP20M	120 (100–150)
		NX2525	170 (150–200)
		UTi20T	100 (70–120)

Work Material	Hardness	Grade	Cutting Speed (m/min)
M Stainless Steel	$\leq 200\text{HB}$	UP20M	120 (80–150)
		UTi20T	100 (70–130)
K Gray Cast Iron	Tensile Strength $\leq 350\text{MPa}$	UP20M	80 (60–100)
		UTi20T	80 (60–100)
		HTi10	100 (70–130)

● : Inventory maintained. ★ : Inventory maintained in Japan.
(10 inserts in one case)

INSERTS

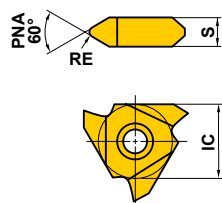
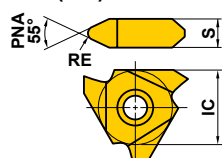
Type	Order Number	Class	Coated		Cermet		Carbide		ISO Pitch mm (thread/inch)	Dimensions (mm)			Geometry
			UP20M	NX2525	UTi20T	HTi10	IC	S		RE			
Partial Profile 60°	MTTR436000	G		●	●			-0.8	12.7	4.76	0	MTTR/L(60°)  Right hand insert shown.	
	MTTR436001	G	★	●	●	★		1.0-1.75	12.7	4.76	0.1		
	MTTL436001	G	★		●	●	★	1.0-1.75	12.7	4.76	0.1		
	MTTR436002	G	★	●	●	●	★	2.0-2.5	12.7	4.76	0.2		
	MTTL436002	G		●	●	●		2.0-2.5	12.7	4.76	0.2		
	MTTR436003	G	★	●	●	●	★	3.0-3.5	12.7	4.76	0.3		
	MTTL436003	G		●	●	●		3.0-3.5	12.7	4.76	0.3		
	MTTR436004	G		●	●	●		4.0-4.5	12.7	4.76	0.4		
Partial Profile 55°	MTTR435501	G		●	●	★		(28-10)	12.7	4.76	0.1	MTTR(55°)  Right hand insert only.	
	MTTR435502	G		●	●	●		(16-8)	12.7	4.76	0.2		
	MTTR435503	G		●	●	●		(11-8)	12.7	4.76	0.3		

STANDARD OF DEPTH OF CUT

- The chart on the right shows the cutting depths when machining external ISO metric screw threads.
- When using cermet grades or cutting stainless steel, please increase the number of passes by 2-3 times.

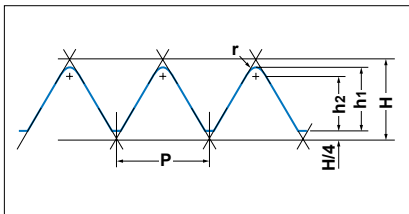

METRIC SCREW THREAD

P (Pitch)	0.75	1.00	1.25	1.50	1.75	2.00	2.50	3.00	3.50	4.00	4.50	
h1	0.46	0.61	0.77	0.92	1.07	1.23	1.53	1.84	2.15	2.45	2.76	
h2	0.35	0.47	0.59	0.70	0.82	0.94	1.17	1.41	1.65	1.87	2.11	
r (Corner Radius)	0.11	0.14	0.18	0.22	0.25	0.29	0.36	0.43	0.50	0.58	0.65	
Number of Passes	1	0.18	0.20	0.20	0.25	0.25	0.25	0.30	0.30	0.35	0.35	0.40
	2	0.13	0.15	0.18	0.20	0.20	0.25	0.25	0.25	0.30	0.30	0.35
	3	0.10	0.10	0.12	0.15	0.20	0.20	0.20	0.25	0.25	0.25	0.30
	4	0.05	0.10	0.12	0.15	0.15	0.15	0.20	0.20	0.20	0.25	0.25
	5		0.06	0.10	0.10	0.12	0.15	0.15	0.20	0.20	0.25	0.25
	6			0.05	0.07	0.10	0.10	0.10	0.15	0.20	0.20	0.20
	7					0.05	0.08	0.10	0.15	0.15	0.20	0.20
	8						0.05	0.10	0.10	0.15	0.15	0.15
	9							0.08	0.10	0.10	0.15	0.15
	10								0.05	0.09	0.10	0.10
	11									0.05	0.10	0.10
	12										0.05	0.10
	13											0.05
	14											

Note 1) The first pass causes a high load on the cutting edge. In order to avoid damage, keep the depth of cut to 0.4-0.5mm maximum.

INTERNAL THREADING

MMTI TYPE BORING BARS

- Minimum cutting diameter 13mm.
- Various insert types.
- Precision class insert.
- Available with a wiper cutting edge to provide a precise thread geometry.
- Able to change lead angle by replacing the shim.

MMTI

Internal threading

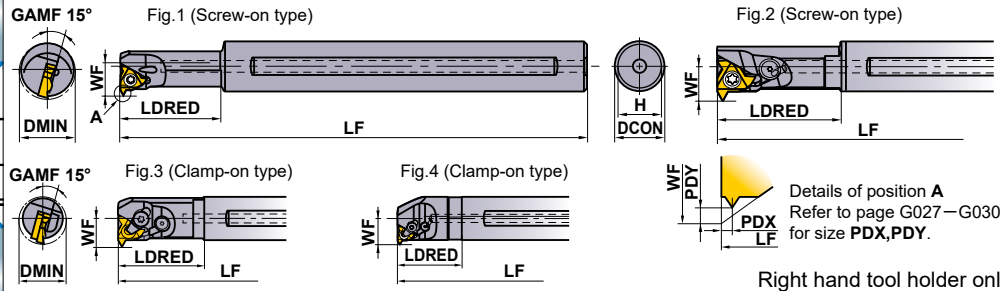

Right hand tool holder only.

Order Number	Stock R	Insert Number	Lead Angle	Dimensions (mm)						Clamp Bridge	Clamp Screw *	Stop Ring	① Shim Screw ② Embedded Seal Screw	Shim	Wrench	Fig
				DCON	LF	LDRED	WF	H	DMIN							
MMTIR1316AK11-SP15	●	MMT111R	1.5°	16	125	25	8.7	15	13	—	TS25	—	—	—	①TKY08F	1
MMTIR1316AK11-SP25	★		2.5°	16	125	25	8.7	15	13	—	TS25	—	—	—	①TKY08F	1
MMTIR1316AK11-SP35	★		3.5°	16	125	25	8.7	15	13	—	TS25	—	—	—	①TKY08F	1
MMTIR1516AM11-SP15	●		1.5°	16	150	32	9.7	15	15	—	TS25	—	—	—	①TKY08F	1
MMTIR1516AM11-SP25	★		2.5°	16	150	32	9.7	15	15	—	TS25	—	—	—	①TKY08F	1
MMTIR1516AM11-SP35	★		3.5°	16	150	32	9.7	15	15	—	TS25	—	—	—	①TKY08F	1
MMTIR1916AM16-SP15	●	MMT161R	1.5°	16	150	40	12.2	15	19	—	CS350860T	—	—	—	①TKY15F	2
MMTIR1916AM16-SP25	★		2.5°	16	150	40	12.2	15	19	—	CS350860T	—	—	—	①TKY15F	2
MMTIR1916AM16-SP35	★		3.5°	16	150	40	12.2	15	19	—	CS350860T	—	—	—	①TKY15F	2
MMTIR2420AQ16-C	●		1.5°	20	180	40	14.2	19	24	SETK51	SETS51	CR4	①HFC03006 ②TFS03006	CTI32TP15	①TKY15F ②HKY20R	3
MMTIR2925AS16-C	●		1.5°	25	250	60	16.7	23.4	29	SETK51	SETS51	CR4	①HFC03006 ②TFS03006	CTI32TP15	①TKY15F ②HKY20R	3
MMTIR3732AS16-C	●		1.5°	32	250	48	20.5	30.4	37	SETK51	SETS51	CR4	①HFC03006 ②TFS03006	CTI32TP15	①TKY15F ②HKY20R	4
MMTIR2420AQ22-SP15	●	MMT221R	1.5°	20	180	50	15.5	19	24	—	TS43	—	—	—	①TKY15F	2
MMTIR2420AQ22-SP25	★		2.5°	20	180	50	15.5	19	24	—	TS43	—	—	—	①TKY15F	2
MMTIR2420AQ22-SP35	★		3.5°	20	180	50	15.5	19	24	—	TS43	—	—	—	①TKY15F	2
MMTIR3025AR22-C	●		1.5°	25	200	38	17.8	23.4	30	SETK61	SETS61	CR5	①HFC04008 ②TFS03006	CTI43TP15	①TKY20F ②HKY25R	4
MMTIR3832AS22-C	●		1.5°	32	250	48	21.8	30.4	38	SETK61	SETS61	CR5	①HFC04008 ②TFS03006	CTI43TP15	①TKY20F ②HKY25R	4
MMTIR4640AT22-C	★		1.5°	40	300	60	26.2	38	46	SETK61	SETS61	CR5	①HFC04008 ②TFS03006	CTI43TP15	①TKY20F ②HKY25R	4

Note 1) Select and use a shim as shown below (sold separately), dependant on the lead angle.

- A screw-on tool holder uses no shim. (The holder body has a lead angle.) Use a tool holder with the appropriate lead angle.
- Min. cutting diameter (DMIN) shows the internal hole diameter, not the thread diameter.

* Clamp Torque (N · m) : TS25=1.0, CS350860T=3.5, SETS51=3.5, TS43=3.5, SETS61=5.0, HFC03006=1.5, HFC04008=2.2

SHIM

Lead Angle (α°)	Order Number	Stock R	Inclination Angle (θ°)	Applicable Holder	Lead Angle (α°)	Order Number	Stock R	Inclination Angle (θ°)	Applicable Holder
-1.5°	CTI32TN15	●	-3°	MMTIR ○○○ ○○16-C	-1.5°	CTI43TN15	●	-3°	MMTIR ○○○ ○○22-C
-0.5°	CTI32TN05	●	-2°		-0.5°	CTI43TN05	●	-2°	
0.5°	CTI32TP05	●	-1°		0.5°	CTI43TP05	●	-1°	
1.5°	CTI32TP15	●	0°		1.5°	CTI43TP15	●	0°	
2.5°	CTI32TP25	●	1°		2.5°	CTI43TP25	●	1°	
3.5°	CTI32TP35	●	2°		3.5°	CTI43TP35	●	2°	
4.5°	CTI32TP45	●	3°	4.5°	CTI43TP45	●	3°		

Standard shim delivered with the holder.

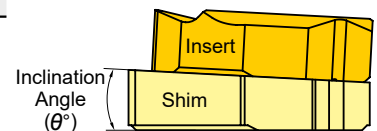

RECOMMENDED CUTTING CONDITIONS

Work Material	Hardness	Grade	Cutting Speed (m/min)
P Mild Steel	≤180HB	VP10MF	150 (70-230)
		VP15TF	100 (60-140)
		VP20RT	80 (60-100)
Carbon Steel Alloy Steel	180-280HB	VP10MF	140 (80-200)
		VP15TF	100 (60-140)
		VP20RT	80 (60-100)
M Stainless Steel	≤200HB	VP15TF	80 (40-120)
K Gray Cast Iron	Tensile Strength ≤350MPa	VP10MF	140 (80-200)
		VP15TF	90 (60-120)

Work Material	Hardness	Grade	Cutting Speed (m/min)
S Heat-Resistant Alloy	—	VP10MF	45 (15-70)
		VP15TF	30 (20-40)
		VP20RT	—
Titanium Alloy	—	VP10MF	60 (40-80)
		VP15TF	45 (25-65)
		VP20RT	—
H Heat-Treated Alloy	45-55HRC	VP10MF	50 (30-70)
		VP15TF	40 (20-60)

● : Inventory maintained. ★ : Inventory maintained in Japan.
(5 inserts in one case)

HOW TO SELECT A SHIM > G012
MMT SERIES ORDER NUMBER > G018

MMT M-CLASS INSERTS WITH 3-D CHIPBREAKERS

INSERTS

Type	Order Number	Coated		Pitch		Dimensions (mm)					Total Cutting Depth (mm)	Geometry
		VP15TF	VP20RT	mm	thread/inch	IC	S	PDY	PDX	RE		
Partial Profile 60°	MMT11IRA60-S	●		0.5-1.5	48-16	6.35	3.04	0.8	0.9	0.03	—	
	MMT16IRA60-S	●		0.5-1.5	48-16	9.525	3.44	0.8	0.9	0.03	—	
	MMT16IRG60-S	●		1.75-3.0	14-8	9.525	3.44	1.2	1.7	0.11	—	
Partial Profile 55°	MMT11IRA55-S	●			48-16	6.35	3.04	0.8	0.9	0.07	—	
	MMT16IRA55-S	●			48-16	9.525	3.44	0.8	0.9	0.07	—	
	MMT16IRG55-S	●			14-8	9.525	3.44	1.2	1.7	0.21	—	
ISO Metric	MMT11IR100ISO-S	●		1.0		6.35	3.04	0.6	0.7	0.06	0.58	
	MMT11IR125ISO-S	●		1.25		6.35	3.04	0.8	0.9	0.08	0.72	
	MMT11IR150ISO-S	●		1.5		6.35	3.04	0.8	1.0	0.10	0.87	
	MMT16IR100ISO-S	●	●	1.0		9.525	3.44	0.6	0.7	0.06	0.58	
	MMT16IR125ISO-S	●	●	1.25		9.525	3.44	0.8	0.9	0.08	0.72	
	MMT16IR150ISO-S	●	●	1.5		9.525	3.44	0.8	1.0	0.10	0.87	
	MMT16IR175ISO-S	●	●	1.75		9.525	3.44	0.9	1.2	0.11	1.01	
	MMT16IR200ISO-S	●	●	2.0		9.525	3.44	1.0	1.3	0.13	1.15	
	MMT16IR250ISO-S	●	●	2.5		9.525	3.44	1.1	1.5	0.17	1.44	
	MMT16IR300ISO-S	●	●	3.0		9.525	3.44	1.1	1.5	0.20	1.73	
American UN	MMT16IR160UN-S	●			16	9.525	3.44	0.9	1.1	0.11	0.92	
	MMT16IR140UN-S	●			14	9.525	3.44	0.9	1.2	0.12	1.05	
	MMT16IR120UN-S	●			12	9.525	3.44	1.1	1.4	0.14	1.22	
Whitworth for BSW, BSP	MMT16IR190W-S	●			19	9.525	3.44	0.8	1.0	0.18	0.86	
	MMT16IR140W-S	●			14	9.525	3.44	1.0	1.2	0.25	1.16	
	MMT16IR110W-S	●			11	9.525	3.44	1.1	1.5	0.32	1.48	
BSPT	MMT16IR190BSPT-S	●			19	9.525	3.44	0.8	0.9	0.18	0.86	
	MMT16IR140BSPT-S	●			14	9.525	3.44	1.0	1.2	0.25	1.16	
	MMT16IR110BSPT-S	●			11	9.525	3.44	1.1	1.5	0.32	1.48	

G
THREADING

IDENTIFICATION

MMT	16	I	R	100	ISO	-	S	M-class inserts with 3-D chipbreakers
Designation	Diameter of Inscribed Circle (mm)	Application	Hand of Tool	Pitch		Threading Type		
	11 6.35 16 9.525	E External I Internal	R Right	100 1.0mm 125 1.25mm 150 1.5mm 175 1.75mm 200 2.0mm 250 2.5mm 300 3.0mm	A 0.5-1.5mm or 48-16 thread/inch G 1.75-3.0mm or 14-8 thread/inch	60 Partial Profile 60° 55 Partial Profile 55° ISO ISO Metric W Whitworth for BSW, BSP BSPT BSPT UN American UN		

INTERNAL THREADING

MMT G-CLASS GROUND INSERTS

INSERTS

Type	Thread Tolerance	Order Number	Coated		Pitch		Dimensions (mm)					Total Cutting Depth (mm)	Geometry
			VP10MF	VP15TF	mm	thread/inch	IC	S	PDY	PDX	RE		
Partial Profile 60°	—	MMT11IRA60	●	●	0.5—1.5	48—16	6.35	3.04	0.8	0.9	0.05	—	
		MMT16IRA60	●	●	0.5—1.5	48—16	9.525	3.44	0.8	0.9	0.05	—	
		MMT16IRG60	●	●	1.75—3.0	14—8	9.525	3.44	1.2	1.7	0.16	—	
		MMT16IRAG60	●	●	0.5—3.0	48—8	9.525	3.44	1.2	1.7	0.05	—	
		MMT22IRN60	●	●	3.5—5.0	7—5	12.7	4.64	1.7	2.5	0.30	—	
Partial Profile 55°	—	MMT11IRA55	●	●		48—16	6.35	3.04	0.8	0.9	0.05	—	
		MMT16IRA55	●	●		48—16	9.525	3.44	0.8	0.9	0.05	—	
		MMT16IRG55	●	●		14—8	9.525	3.44	1.2	1.7	0.21	—	
		MMT16IRAG55	●	●		48—8	9.525	3.44	1.2	1.7	0.07	—	
		MMT22IRN55	●	●		7—5	12.7	4.64	1.7	2.5	0.44	—	
ISO Metric	6H	MMT11IR050ISO	●	●	0.5		6.35	3.04	0.6	0.4	0.03	0.29	
		MMT11IR075ISO	●	●	0.75		6.35	3.04	0.6	0.6	0.04	0.43	
		MMT11IR100ISO	●	●	1.0		6.35	3.04	0.6	0.7	0.10	0.58	
		MMT11IR125ISO	●	●	1.25		6.35	3.04	0.8	0.9	0.12	0.72	
		MMT11IR150ISO	●	●	1.5		6.35	3.04	0.8	1.0	0.14	0.87	
		MMT11IR175ISO	●	●	1.75		6.35	3.04	0.9	1.1	0.10	1.01	
		MMT11IR200ISO	●	●	2.0		6.35	3.04	0.9	1.1	0.18	1.15	
		MMT16IR050ISO	●	●	0.5		9.525	3.44	0.6	0.4	0.03	0.29	
		MMT16IR075ISO	●	●	0.75		9.525	3.44	0.6	0.6	0.04	0.43	
		MMT16IR100ISO	●	●	1.0		9.525	3.44	0.6	0.7	0.10	0.58	
		MMT16IR125ISO	●	●	1.25		9.525	3.44	0.8	0.9	0.12	0.72	
		MMT16IR150ISO	●	●	1.5		9.525	3.44	0.8	1.0	0.14	0.87	
		MMT16IR175ISO	●	●	1.75		9.525	3.44	0.9	1.2	0.10	1.01	
		MMT16IR200ISO	●	●	2.0		9.525	3.44	1.0	1.3	0.18	1.15	
		MMT16IR250ISO	●	●	2.5		9.525	3.44	1.1	1.5	0.15	1.44	
		MMT16IR300ISO	●	●	3.0		9.525	3.44	1.1	1.5	0.26	1.73	
		MMT22IR350ISO	●	●	3.5		12.7	4.64	1.6	2.3	0.22	2.02	
		MMT22IR400ISO	●	●	4.0		12.7	4.64	1.6	2.3	0.25	2.31	
		MMT22IR450ISO	●	●	4.5		12.7	4.64	1.6	2.4	0.28	2.60	
MMT22IR500ISO	●	●	5.0		12.7	4.64	1.6	2.3	0.32	2.89			

G
THREADING

IDENTIFICATION

MMT	16	I	R	050	ISO																																																																
Designation	Diameter of Inscribed Circle (mm)	Application	Hand of Tool	Pitch	Threading Type																																																																
	11 6.35 16 9.525 22 12.7	E External I Internal	R Right	<table border="1"> <tr> <td>050</td> <td>0.5mm</td> <td rowspan="2">A</td> <td rowspan="2">0.5—1.5mm or 48—16 thread/inch</td> </tr> <tr> <td>075</td> <td>0.75mm</td> </tr> <tr> <td>100</td> <td>1.0mm</td> <td rowspan="3">G</td> <td rowspan="3">1.75—3.0mm or 14—8 thread/inch</td> </tr> <tr> <td>125</td> <td>1.25mm</td> </tr> <tr> <td>150</td> <td>1.5mm</td> </tr> <tr> <td>175</td> <td>1.75mm</td> <td rowspan="4">AG</td> <td rowspan="4">0.5—3.0mm or 48—8 thread/inch</td> </tr> <tr> <td>200</td> <td>2.0mm</td> </tr> <tr> <td>250</td> <td>2.5mm</td> </tr> <tr> <td>300</td> <td>3.0mm</td> </tr> <tr> <td>350</td> <td>3.5mm</td> <td rowspan="3">N</td> <td rowspan="3">3.5—5.0mm or 7—5 thread/inch</td> </tr> <tr> <td>400</td> <td>4.0mm</td> </tr> <tr> <td>450</td> <td>4.5mm</td> </tr> <tr> <td>500</td> <td>5.0mm</td> <td></td> <td></td> </tr> </table>	050	0.5mm	A	0.5—1.5mm or 48—16 thread/inch	075	0.75mm	100	1.0mm	G	1.75—3.0mm or 14—8 thread/inch	125	1.25mm	150	1.5mm	175	1.75mm	AG	0.5—3.0mm or 48—8 thread/inch	200	2.0mm	250	2.5mm	300	3.0mm	350	3.5mm	N	3.5—5.0mm or 7—5 thread/inch	400	4.0mm	450	4.5mm	500	5.0mm			<table border="1"> <tr> <td>60</td> <td>Partial Profile 60°</td> </tr> <tr> <td>55</td> <td>Partial Profile 55°</td> </tr> <tr> <td>ISO</td> <td>ISO Metric</td> </tr> <tr> <td>W</td> <td>Whitworth for BSW, BSP</td> </tr> <tr> <td>BSPT</td> <td>BSPT</td> </tr> <tr> <td>UN</td> <td>American UN</td> </tr> <tr> <td>RD</td> <td>Round DIN 405</td> </tr> <tr> <td>TR</td> <td>ISO Trapezoidal 30°</td> </tr> <tr> <td>ACME</td> <td>American ACME</td> </tr> <tr> <td>UNJ</td> <td>UNJ</td> </tr> <tr> <td>APBU</td> <td>API Buttress Casing</td> </tr> <tr> <td>APRD</td> <td>API Round Casing&Tubing</td> </tr> <tr> <td>NPT</td> <td>NPT</td> </tr> <tr> <td>NPTF</td> <td>NPTF</td> </tr> </table>	60	Partial Profile 60°	55	Partial Profile 55°	ISO	ISO Metric	W	Whitworth for BSW, BSP	BSPT	BSPT	UN	American UN	RD	Round DIN 405	TR	ISO Trapezoidal 30°	ACME	American ACME	UNJ	UNJ	APBU	API Buttress Casing	APRD	API Round Casing&Tubing	NPT	NPT	NPTF	NPTF
050	0.5mm	A	0.5—1.5mm or 48—16 thread/inch																																																																		
075	0.75mm																																																																				
100	1.0mm	G	1.75—3.0mm or 14—8 thread/inch																																																																		
125	1.25mm																																																																				
150	1.5mm																																																																				
175	1.75mm	AG	0.5—3.0mm or 48—8 thread/inch																																																																		
200	2.0mm																																																																				
250	2.5mm																																																																				
300	3.0mm																																																																				
350	3.5mm	N	3.5—5.0mm or 7—5 thread/inch																																																																		
400	4.0mm																																																																				
450	4.5mm																																																																				
500	5.0mm																																																																				
60	Partial Profile 60°																																																																				
55	Partial Profile 55°																																																																				
ISO	ISO Metric																																																																				
W	Whitworth for BSW, BSP																																																																				
BSPT	BSPT																																																																				
UN	American UN																																																																				
RD	Round DIN 405																																																																				
TR	ISO Trapezoidal 30°																																																																				
ACME	American ACME																																																																				
UNJ	UNJ																																																																				
APBU	API Buttress Casing																																																																				
APRD	API Round Casing&Tubing																																																																				
NPT	NPT																																																																				
NPTF	NPTF																																																																				

● : Inventory maintained. ★ : Inventory maintained in Japan.
(5 inserts in one case)

INSERTS

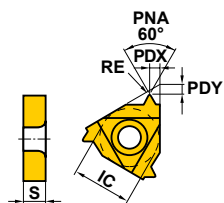
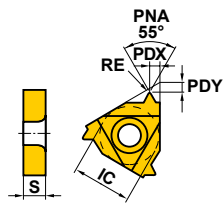
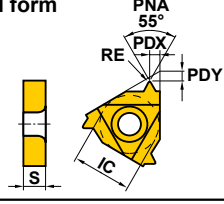
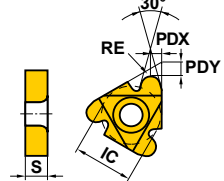
Type	Thread Tolerance	Order Number	Coated		Pitch		Dimensions (mm)					Total Cutting Depth (mm)	Geometry
			VP10MF	VP15TF	mm	thread/inch	IC	S	PDY	PDX	RE		
American UN	2B	MMT11IR320UN	★			32	6.35	3.04	0.6	0.6	0.04	0.46	Full form 
		MMT11IR280UN	★			28	6.35	3.04	0.6	0.7	0.05	0.52	
		MMT11IR240UN	●			24	6.35	3.04	0.7	0.8	0.09	0.61	
		MMT11IR200UN	●			20	6.35	3.04	0.8	0.9	0.11	0.73	
		MMT11IR180UN	●			18	6.35	3.04	0.8	1.0	0.12	0.81	
		MMT11IR160UN	●			16	6.35	3.04	0.9	1.1	0.14	0.92	
		MMT11IR140UN	●			14	6.35	3.04	0.9	1.1	0.11	1.05	
		MMT16IR320UN	●			32	9.525	3.44	0.6	0.6	0.04	0.46	
		MMT16IR280UN	●			28	9.525	3.44	0.6	0.7	0.05	0.52	
		MMT16IR240UN	●			24	9.525	3.44	0.7	0.8	0.09	0.61	
		MMT16IR200UN	●			20	9.525	3.44	0.8	0.9	0.11	0.73	
		MMT16IR180UN	●			18	9.525	3.44	0.8	1.0	0.12	0.81	
		MMT16IR160UN	● ●			16	9.525	3.44	0.9	1.1	0.14	0.92	
		MMT16IR140UN	● ●			14	9.525	3.44	0.9	1.2	0.11	1.05	
		MMT16IR130UN	● ●			13	9.525	3.44	1.0	1.3	0.10	1.13	
		MMT16IR120UN	● ●			12	9.525	3.44	1.1	1.4	0.18	1.22	
		MMT16IR110UN	●			11	9.525	3.44	1.1	1.5	0.13	1.33	
		MMT16IR100UN	●			10	9.525	3.44	1.1	1.5	0.15	1.47	
		MMT16IR090UN	●			9	9.525	3.44	1.2	1.7	0.17	1.63	
		MMT16IR080UN	●			8	9.525	3.44	1.1	1.5	0.27	1.83	
MMT22IR070UN	●			7	12.7	4.64	1.6	2.3	0.23	2.09			
MMT22IR060UN	●			6	12.7	4.64	1.6	2.3	0.26	2.44			
MMT22IR050UN	●			5	12.7	4.64	1.6	2.3	0.32	2.93			
Whitworth for BSW, BSP	Medium Class A	MMT11IR190W	●			19	6.35	3.04	0.8	1.0	0.19	0.86	Full form 
		MMT11IR140W	●			14	6.35	3.04	0.9	1.1	0.26	1.16	
		MMT16IR280W	●			28	9.525	3.44	0.6	0.7	0.09	0.58	
		MMT16IR260W	●			26	9.525	3.44	0.7	0.8	0.10	0.63	
		MMT16IR200W	●			20	9.525	3.44	0.8	0.9	0.18	0.81	
		MMT16IR190W	● ●			19	9.525	3.44	0.8	1.0	0.19	0.86	
		MMT16IR180W	●			18	9.525	3.44	0.8	1.0	0.20	0.90	
		MMT16IR160W	●			16	9.525	3.44	0.9	1.1	0.23	1.02	
		MMT16IR140W	● ●			14	9.525	3.44	1.0	1.2	0.26	1.16	
		MMT16IR120W	● ●			12	9.525	3.44	1.1	1.4	0.30	1.36	
		MMT16IR110W	● ●			11	9.525	3.44	1.1	1.5	0.33	1.48	
		MMT16IR100W	●			10	9.525	3.44	1.1	1.5	0.37	1.63	
		MMT16IR090W	●			9	9.525	3.44	1.2	1.7	0.34	1.81	
		MMT16IR080W	●			8	9.525	3.44	1.2	1.5	0.39	2.03	
		MMT22IR070W	●			7	12.7	4.64	1.6	2.3	0.46	2.32	
MMT22IR060W	●			6	12.7	4.64	1.6	2.3	0.53	2.71			
MMT22IR050W	●			5	12.7	4.64	1.7	2.4	0.66	3.25			
BSPT	Standard BSPT	MMT11IR190BSPT	●			19	6.35	3.04	0.8	0.9	0.14	0.86	Full form 
		MMT11IR140BSPT	●			14	6.35	3.04	0.9	1.0	0.26	1.16	
		MMT16IR190BSPT	★ ★			19	9.525	3.44	0.8	0.9	0.14	0.86	
		MMT16IR140BSPT	★ ★			14	9.525	3.44	1.0	1.2	0.26	1.16	
		MMT16IR110BSPT	★ ★			11	9.525	3.44	1.1	1.5	0.33	1.48	
Round DIN 405	7H	MMT16IR100RD	●			10	9.525	3.44	1.1	1.2	0.55	1.27	Full form 
		MMT16IR080RD	●			8	9.525	3.44	1.4	1.4	0.70	1.59	
		MMT16IR060RD	●			6	9.525	3.44	1.4	1.5	0.93	2.12	
		MMT22IR040RD	●			4	12.7	4.64	2.2	2.3	1.40	3.18	

G

THREADING

INTERNAL THREADING

MMT G-CLASS GROUND INSERTS

INSERTS

Type	Thread Tolerance	Order Number	Coated VP10MF	Pitch		Dimensions (mm)					Total Cutting Depth (mm)	Geometry
				mm	thread/inch	IC	S	PDY	PDX	RE		
ISO Trapezoidal 30°	7H	MMT16IR150TR	●	1.5		9.525	3.44	1.0	1.1	0.08	0.90	
		MMT16IR200TR	●	2.0		9.525	3.44	1.1	1.3	0.15	1.25	
		MMT16IR300TR	●	3.0		9.525	3.44	1.3	1.5	0.15	1.75	
		MMT22IR400TR	●	4.0		12.7	4.64	1.7	1.9	0.15	2.25	
		MMT22IR500TR	●	5.0		12.7	4.64	2.1	2.5	0.15	2.75	
American ACME	3G	MMT16IR120ACME	●		12	9.525	3.44	1.2	1.3	0.05	1.19	
		MMT16IR100ACME	●		10	9.525	3.44	1.2	1.3	0.08	1.52	
		MMT16IR080ACME	●		8	9.525	3.44	1.4	1.5	0.10	1.84	
		MMT22IR060ACME	●		6	12.7	4.64	1.8	2.1	0.10	2.37	
		MMT22IR050ACME	●		5	12.7	4.64	2.0	2.3	0.10	2.79	
UNJ		When machining an internal UNJ thread, cut an internal hole with the appropriate diameter. Then machine with 60° American UN. In this case, a full form type insert cannot be used.										
API Buttress Casing	Standard API	MMT22IR050APBU	●		5	12.7	4.64	2.8	1.9	0.18	1.55	
API Round Casing & Tubing	Standard API RD	MMT16IR100APRD	●		10	9.525	3.44	1.2	1.4	0.34	1.41	
		MMT16IR080APRD	●		8	9.525	3.44	1.3	1.5	0.41	1.81	
American NPT	Standard NPT	MMT16IR270NPT	★		27	9.525	3.44	0.7	0.8	0.04	0.66	
		MMT16IR180NPT	★		18	9.525	3.44	0.8	1.0	0.08	1.01	
		MMT16IR140NPT	●		14	9.525	3.44	0.9	1.2	0.09	1.33	
		MMT16IR115NPT	●		11.5	9.525	3.44	1.1	1.5	0.11	1.64	
		MMT16IR080NPT	●		8	9.525	3.44	1.3	1.8	0.14	2.42	
American NPTF	Class 2	MMT16IR140NPTF	★		14	9.525	3.44	0.9	1.2	0.04	1.35	
		MMT16IR115NPTF	★		11.5	9.525	3.44	1.1	1.5	0.04	1.63	
		MMT16IR080NPTF	★		8	9.525	3.44	1.3	1.8	0.04	2.38	

G THREADING

● : Inventory maintained. ★ : Inventory maintained in Japan.
(5 inserts in one case)

MICRO-MINI TWIN

CT STANDARD

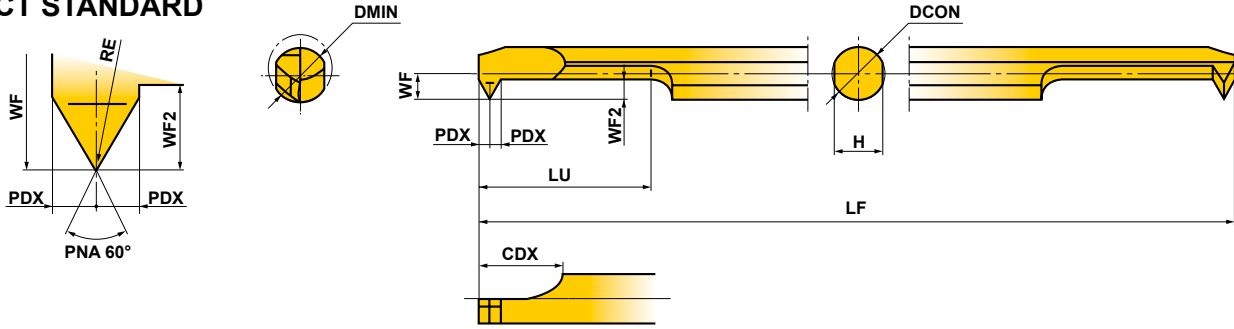

Order Number	Stock		Breaker	Threads				Dimensions (mm)									
	Micro Grain Carbide	Coated		Metric Screw		Unified Coarse Screw		DMIN	RE	DCON	LF	LU	CDX	WF	PDX	WF2	H
				Thread	Pitch (mm)	Thread	Pitch (thread/inch)										
	TF15	VP15TF															
CT0305RS-M4	★	★	Without	≥ M4	0.5-1.0	≥ NO.8-32UNC	36-24	3	0.03	3	50	5.2	6	1.3	0.6	1.2	2.7
CT03RS-M4	●	●	Without	≥ M4	0.5-1.0	≥ NO.8-36UNF	36-24	3	0.03	3	50	10.2	6	1.3	0.6	1.2	2.7
CT03RS-M4B	●	●	With	≥ M4	0.5-1.0		36-24	3	0.03	3	50	10.2	6	1.3	0.6	1.2	2.7
CT0407RS-M6	★	★	Without	≥ M6	0.75-1.25	≥ 1/4-20UNC	28-20	4.5	0.05	4	60	7.6	7	1.8	0.8	1.7	3.6
CT04RS-M6	●	●	Without	≥ M6	0.75-1.25	≥ 1/4-28UNF	28-20	4.5	0.05	4	60	15.6	7	1.8	0.8	1.7	3.6
CT04RS-M6B	●	●	With	≥ M6	0.75-1.25		28-20	4.5	0.05	4	60	15.6	7	1.8	0.8	1.7	3.6
CT0511RS-M8	★	★	Without	≥ M8	0.75-1.5	≥ 5/16-18UNC	24-18	6	0.05	5	70	11	8	2.3	1	2.2	4.5
CT05RS-M8	●	●	Without	≥ M8	0.75-1.5	≥ 5/16-24UNF	24-18	6	0.05	5	70	21	8	2.3	1	2.2	4.5
CT05RS-M8B	●	●	With	≥ M8	0.75-1.5		24-18	6	0.05	5	70	21	8	2.3	1	2.2	4.5
CT0611RS-M10	★	★	Without	≥ M10	0.75-1.75	≥ 3/8-16UNC	24-16	7	0.05	6	75	11	8	2.8	1	2.2	5.4
CT06RS-M10	●	●	Without	≥ M10	0.75-1.75	≥ 3/8-24UNF	24-16	7	0.05	6	75	21	8	2.8	1	2.2	5.4
CT06RS-M10B	●	●	With	≥ M10	0.75-1.75		24-16	7	0.05	6	75	21	8	2.8	1	2.2	5.4

RECOMMENDED CUTTING CONDITIONS

Work Material	Cutting Speed (m/min)	Recommended Tool Overhang (mm)
P Carbon Steel Alloy Steel	50 (30-80)	
M Stainless Steel	50 (30-80)	
K Cast Iron	50 (30-80)	
N Non-Ferrous Metal	80 (50-100)	

(Note 1) Wet cutting is recommended.
 (Note 2) Pay special attention to machining of small diameters at high revolutions as the feed rate cannot keep up with the speed.

STANDARD OF DEPTH OF CUT

● The chart on the right shows the cutting depths when machining external ISO metric screw threads.

Metric

P(Pitch)	0.50	0.75	1.00	1.25	1.50	1.75
Total Cutting Depth	0.29	0.43	0.58	0.72	0.87	1.01
Number of Passes	1	0.06	0.06	0.07	0.07	0.07
	2	0.05	0.06	0.06	0.07	0.07
	3	0.05	0.05	0.06	0.07	0.07
	4	0.04	0.05	0.05	0.07	0.07
	5	0.03	0.04	0.05	0.06	0.06
	6	0.03	0.04	0.05	0.06	0.06
	7	0.02	0.04	0.04	0.05	0.06
	8	0.01	0.03	0.04	0.05	0.06
	9	-	0.03	0.04	0.05	0.05
	10	-	0.02	0.03	0.04	0.05
	11	-	0.01	0.03	0.04	0.05
	12	-	-	0.03	0.03	0.04
	13	-	-	0.02	0.03	0.04
	14	-	-	0.01	0.02	0.03
	15	-	-	-	0.01	0.03
	16	-	-	-	-	0.03
	17	-	-	-	-	0.02
	18	-	-	-	-	0.01
	19	-	-	-	-	-
	20	-	-	-	-	-
	21	-	-	-	-	-

● : Inventory maintained. ★ : Inventory maintained in Japan.
 (MICRO-MINI TWIN is available in 1 piece in one pack.)

SPARE PARTS > N001
 TECHNICAL DATA > P001

INTERNAL THREADING

PRECAUTIONS WHEN USING THE MICRO-MINI TWIN

● When using a holder for general purpose / small automatic lathe:

① To avoid chipping of the 2nd cutting edge take care when inserting the boring bar into the holder. Refer to fig.1. If the 2nd edge contacts the internal face of the holder there is a possibility that it may chip.

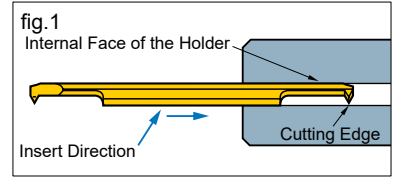

② When using this type of holder, there is a possibility that damage to the shank and the 2nd cutting edge can occur. Make sure that the clamping screws are tightened to the set torque value. Additionally make sure that there is no clamping screw near the 2nd cutting edge as this can break the boring bar.

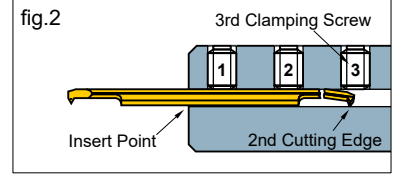

◎ When using Mitsubishi holders

When using holders with a tool overhang of recommended quantity, ensure that the 3rd clamping screw is removed prior to machining. The set torque value for the clamping screw is 2.0 N · m.

● When using a square type holder:

① When installing the boring bar into the holder, tighten the clamp screws after ensuring the flats on the tool holder are parallel to the reference flats on the micro-mini bar. Refer to fig.3.

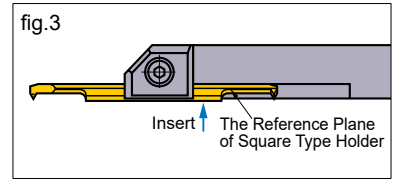

② Make sure that the clamping screws are tightened to the recommended values.

③ Do not tighten the clamp screw without a bar in place, otherwise the bridge will be deformed.

G

SQUARE TYPE HOLDER

THREADING

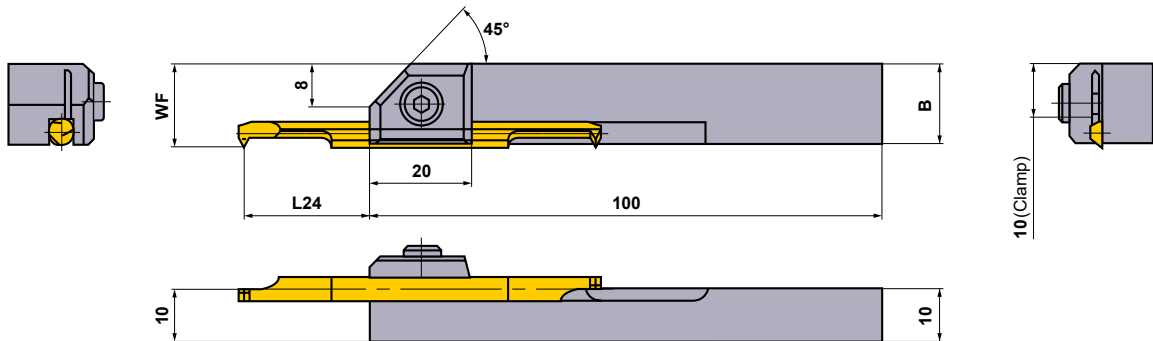

Order Number	Stock	Dimensions (mm)			Micro-Mini Twin CT	Clamp Screw	Wrench	Torque (N·m)
		Micro-Mini Twin CT						
		B	WF	L24 *				
SBH1030R	★	13.8	13.8	13—17.5(14)	0305RS-M4, 03RS-M4(B)	HSC05012	HKY40R	9.5
SBH1040R	★	14.7	14.8	18.5—22(19.5)	0407RS-M6, 04RS-M6(B)	HSC05012	HKY40R	9.5
SBH1050R	★	15.6	15.8	24—26.5(25)	0511RS-M8, 05RS-M8(B)	HSC05012	HKY40R	9.5
SBH1060R	★	16.5	16.8	24—31.5(25)	0611RS-M10, 06RS-M10(B)	HSC05012	HKY40R	9.5

* L24 is the length of overhang for sufficient clamping, and () is the recommended length for machining of carbon and alloy steel.

ROUND TYPE HOLDER

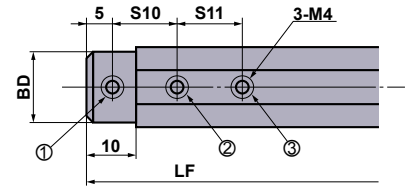
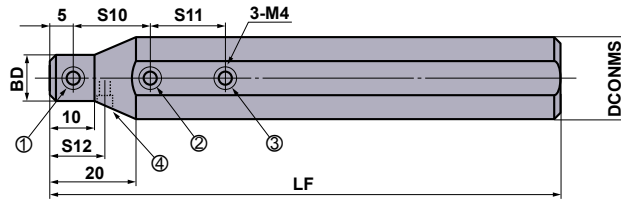
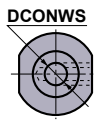

RBH158○N, RBH16○N,
RBH190○N

RBH22○N has a temporary set screw for different machine specifications.
(Represented by number 4)

Order Number	Stock	Dimensions (mm)						Micro-Mini Twin CT	★1 Clamp Screw				Wrench	Torque (N·m)	
		DCONMS	DCONWS	BD	LF	S10	S11		S12	①	②	③			④
RBH15830N	★	15.875	3	15	100	10	10	—	0305RS-M4, 03RS-M4(B)	A	A	A	—	HKY20F	2.0
RBH15840N	★	15.875	4	15	100	15	15	—	0407RS-M6, 04RS-M6(B)	A	A	A	—	HKY20F	2.0
RBH15850N	★	15.875	5	15	100	15	15	—	0511RS-M8, 05RS-M8(B)	A	A	A	—	HKY20F	2.0
RBH15860N	★	15.875	6	15	100	15	15	—	0611RS-M10, 06RS-M10(B)	A	A	A	—	HKY20F	2.0
RBH1630N	●	16	3	15	100	10	10	—	0305RS-M4, 03RS-M4(B)	A	A	A	—	HKY20F	2.0
RBH1640N	●	16	4	15	100	15	15	—	0407RS-M6, 04RS-M6(B)	A	A	A	—	HKY20F	2.0
RBH1650N	●	16	5	15	100	15	15	—	0511RS-M8, 05RS-M8(B)	A	A	A	—	HKY20F	2.0
RBH1660N	●	16	6	15	100	15	15	—	0611RS-M10, 06RS-M10(B)	A	A	A	—	HKY20F	2.0
*2 RBH19030N	★	19.05	3	18	125	10	10	—	0305RS-M4, 03RS-M4(B)	B	B	B	—	HKY20F	2.0
*2 RBH19040N	★	19.05	4	18	125	15	15	—	0407RS-M6, 04RS-M6(B)	B	B	B	—	HKY20F	2.0
*2 RBH19050N	★	19.05	5	18	125	15	15	—	0511RS-M8, 05RS-M8(B)	B	B	B	—	HKY20F	2.0
*2 RBH19060N	★	19.05	6	18	125	15	15	—	0611RS-M10, 06RS-M10(B)	B	B	B	—	HKY20F	2.0
RBH2030N	★	20	3	12	125	10	10	—	0305RS-M4, 03RS-M4(B)	A	A	B	—	HKY20F	2.0
RBH2040N	★	20	4	13	125	15	15	—	0407RS-M6, 04RS-M6(B)	A	B	B	—	HKY20F	2.0
RBH2050N	★	20	5	14	125	15	15	—	0511RS-M8, 05RS-M8(B)	A	B	B	—	HKY20F	2.0
RBH2060N	★	20	6	15	125	15	15	—	0611RS-M10, 06RS-M10(B)	A	B	B	—	HKY20F	2.0
RBH2230N	★	22	3	12	125	10	10	10	0305RS-M4, 03RS-M4(B)	A	B	C	A	HKY20F	2.0
RBH2240N	★	22	4	13	125	15	15	12.5	0407RS-M6, 04RS-M6(B)	A	B	B	A	HKY20F	2.0
RBH2250N	★	22	5	14	125	15	15	12.5	0511RS-M8, 05RS-M8(B)	A	B	B	A	HKY20F	2.0
RBH2260N	★	22	6	15	125	15	15	15	0611RS-M10, 06RS-M10(B)	A	B	B	A	HKY20F	2.0
RBH2530N	★	25	3	12	150	10	10	—	0305RS-M4, 03RS-M4(B)	A	B	C	—	HKY20F	2.0
RBH2540N	★	25	4	13	150	15	15	—	0407RS-M6, 04RS-M6(B)	A	C	C	—	HKY20F	2.0
RBH2550N	★	25	5	14	150	15	15	—	0511RS-M8, 05RS-M8(B)	A	C	C	—	HKY20F	2.0
RBH2560N	★	25	6	15	150	15	15	—	0611RS-M10, 06RS-M10(B)	A	C	C	—	HKY20F	2.0
RBH25430N	★	25.4	3	12	150	10	10	—	0305RS-M4, 03RS-M4(B)	A	B	C	—	HKY20F	2.0
RBH25440N	★	25.4	4	13	150	15	15	—	0407RS-M6, 04RS-M6(B)	A	C	C	—	HKY20F	2.0
RBH25450N	★	25.4	5	14	150	15	15	—	0511RS-M8, 05RS-M8(B)	A	C	C	—	HKY20F	2.0
RBH25460N	★	25.4	6	15	150	15	15	—	0611RS-M10, 06RS-M10(B)	A	C	C	—	HKY20F	2.0

*1 Order number of clamp screw A=HSS04004, B=HSS04006, C=HSS04008

*2 Revised order number.

Conventional Order Number	Revised Order Number
RBH1930N	RBH19030N
RBH1940N	RBH19040N
RBH1950N	RBH19050N
RBH1960N	RBH19060N

● : Inventory maintained. ★ : Inventory maintained in Japan.

SPARE PARTS > N001
TECHNICAL DATA > P001

Memo

A series of horizontal dashed lines for writing, spanning the width of the page.

Memo

A series of horizontal dashed lines for writing, spanning the width of the page.

HOW TO READ THE STANDARD OF HSK-T TOOLS

●How this section page is organised

- ①Organised by product series.
(Refer to the index on the next page.)

PRODUCT TYPE

Indicates the first four letters of the order number, as well as cutting applications.

TITLE OF PRODUCT SERIES

PRODUCT SECTION

● HSK-T TOOLS

● HSK-T SYSTEM

● PCLN

External turning • Facing

Order Number	Stock	Insert Number	Dimensions (mm)		#1	#2	Shim	Shim Pin	Clamp Lever	Clamp Screw	Wrench	
			DCOM	LF								
H63TH-PCLNRIL-DX12	●	CN/GA CN/G CN/M	1204	63	65	45	1.3	LLSCN42	LLP14	LLCL14	LLCS108	HKY30R

Right hand tool holder shown.

*1 Clamp Torque (N • m) : LLCS108x3.3
*2 WT : Tool Weight
Note 1) Dimensions shown for insert corner RE 0.8.

● DCLN

External turning • DOUBLE CLAMP type

Order Number	Stock	Insert Number	Dimensions (mm)		#1	#2	Shim	Shim Pin	Clamp Bridge	Spring	Clamp Screw	Wrench	
			DCOM	LF									
H63TH-DCLNRIL-DX12	●	CN/GA CN/G CN/M	1204	63	65	45	1.3	LLSCN42	LLP14	DCK2613	DCS1	DC0621T	TKY20F

Right hand tool holder shown.

*1 Clamp Torque (N • m) : DC0621T=5.0
*2 WT : Tool Weight
Note 1) Dimensions shown for insert corner RE 0.8.

H006 ● Inventory maintained.

LEGEND FOR STOCK STATUS MARK
Is shown on the left hand page of each double-page spread.

PRODUCT STANDARDS
Indicates order numbers, stock status (per right/left hand), applicable inserts, dimensions, and spare parts.

FIGURE SHOWING THE TOOLING APPLICATION
Uses illustrations and arrows to depict available machining applications along with cutting edge lead angles.

GEOMETRY

CHIPBREAKER BY CUTTING APPLICATION

● PCMN

External turning • Facing

Order Number	Stock	Insert Number	Dimensions (mm)		#1	#2	Shim	Shim Pin	Clamp Lever	Clamp Screw	Plug	Wrench
			DCOM	LF								
H63TH-PCMNN-H12	●	CN/GA CN/G CN/M	1204	63	100	1.7	LLSCN42	LLP14	LLCL14	LLCS108	HGM-P118	HKY30R
H63TH-PCMNN-L12	●	CN/GA CN/G CN/M	1204	63	140	2.7	LLSCN42	LLP14	LLCL14	LLCS108	HGM-P118	HKY30R

Right hand tool holder shown.

*1 Clamp Torque (N • m) : LLCS108x3.3
*2 WT : Tool Weight
Note 1) Dimensions shown for insert corner RE 0.8.

● DCMN

External turning • DOUBLE CLAMP type

Order Number	Stock	Insert Number	Dimensions (mm)		#1	#2	Shim	Shim Pin	Clamp Bridge	Spring	Clamp Screw	Wrench
			DCOM	LF								
H63TH-DCMNN-H12	●	CN/GA CN/G CN/M	1204	63	100	1.7	LLSCN42	LLP14	DCK2613	DCS1	DC0621T	TKY20F
H63TH-DCMNN-L12	●	CN/GA CN/G CN/M	1204	63	140	2.7	LLSCN42	LLP14	DCK2613	DCS1	DC0621T	TKY20F

Right hand tool holder shown.

*1 Clamp Torque (N • m) : DC0621T=5.0
*2 WT : Tool Weight
Note 1) Dimensions shown for insert corner RE 0.8.

PCMN type inserts > A98-A104
DCMN type inserts > A98-A104
PCLN & PCD inserts > B036-B038, B064
RECOMMENDED CUTTING CONDITIONS > A074
RECOMMENDED CUTTING CONDITIONS > A074
SPARE PARTS > N091
TECHNICAL DATA > P001

REFERENCE PAGE FOR APPLICABLE INSERTS
Indicates reference pages for details of inserts that are applicable to the product.

PAGE REFERENCE • SPARE PARTS • TECHNICAL DATA
Indicates reference pages, including the above, on the right hand page of each double-page spread.

- To Order : Please specify
- ① order number and hand of tool (right/left).

HSK-T TOOLS

OVERVIEW OF HSK-T TOOLS.....	H002
CLASSIFICATION OF HSK-T TOOLS.....	H004
HSK-T TOOL STANDARDS	
EXTERNAL TURNING • FACING	
CN ^{○○} INSERTS TOOL HOLDERS.....	H006
DN ^{○○} INSERTS TOOL HOLDERS.....	H011
EXTERNAL TURNING • FACING • BORING	
CN ^{○○} INSERTS TOOL HOLDERS.....	H008
EXTERNAL TURNING • COPYING	
DN ^{○○} INSERTS TOOL HOLDERS.....	H009
EXTERNAL TURNING • FACING • COPYING	
RC ^{○○} INSERTS TOOL HOLDERS.....	H012
FACING • COPYING	
VB ^{○○} INSERTS TOOL HOLDERS.....	H013
GROOVING	
MG INSERTS TOOL HOLDERS.....	H014
THREADING	
MMT INSERTS TOOL HOLDERS.....	H016
MT INSERTS TOOL HOLDERS.....	H017
EXTERNAL TURNING TOOL HOLDERS.....	H019
BORING BAR HOLDERS.....	H021
BORING BAR SLEEVES.....	H022

*Alphabetical order index

H022 H100TH-B ^{○○○○}	H014 H63TH-MGHR/L-DX43 ^{○○}
H020 H100TH-EN3232R/L-130	H016 H63TH-MMTER-H/L16
H019 H100TH-EV3232R/L-180	H016 H63TH-MMTER-DX16
H008 H63TH-A ^{○○○○} DCLNR/L12	H017 H63TH-MTHR/L-DX43
H021 H63TH-B ^{○○○○}	H006 H63TH-PCLNR/L-DX12
H008 H63TH-DCLNL-L12-3	H007 H63TH-PCMNN-H/L12
H006 H63TH-DCLNR/L-DX12	H009 H63TH-PDJNR/L-DX15
H007 H63TH-DCMNN-H/L12	H010 H63TH-PDNNN-H/L15
H011 H63TH-DDJNL-L15-3	H012 H63TH-PRDCN-H/L12
H009 H63TH-DDJNR/L-DX15	H012 H63TH-PRGCR/L-DX12
H010 H63TH-DDNNN-H/L15	H013 H63TH-SVPBR/L-DX16
H020 H63TH-EN2525R/L-115	H013 H63TH-SVVBH-H/L16
H021 H63TH-EV2020R/L-105-3	H022 SL32 ^{○○} -90
H019 H63TH-EV2525R/L-112	



Tooling system
for turning on
multi-task machines

HSK TOOLS

HSK-T System

HSK-T is a new type of HSK system designed for turning on multi-task machines that are compatible with HSK-A type (ISO standard: ISO12164-1:2001). The HSK system was developed by a consortium of 17 Japanese manufacturers and registered in ISO standard (ISO12164-3:2008) under the name HSK-T type in 2008 and JIS standard (JIS B6064-3) in 2013.



High accuracy cutting edge positioning

The HSK-T type has a closer tolerance between the spindle key and tool holder keyway than the HSK-A type. This results in higher cutting edge positional accuracy. For milling, the conventional HSK-A type tools can be still used.

Compatible with both multi-task machines and machining centres

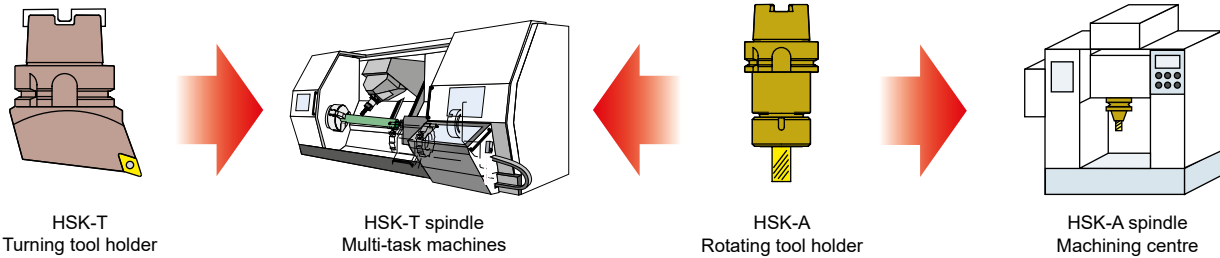

HSK-T
Turning tool holder

HSK-T spindle
Multi-task machines

HSK-A
Rotating tool holder

HSK-A spindle
Machining centre

HSK-T TOOLS

***Note**
Short neck length from the flange with thick body of the HSK-T turning tool as shown in the figure at the left. Because there are machines which cannot be mounted depending on the ATC specifications of the multi-task machine (HSK-A type), please check beforehand. Also be careful of interference in the magazine with adjacent tools.

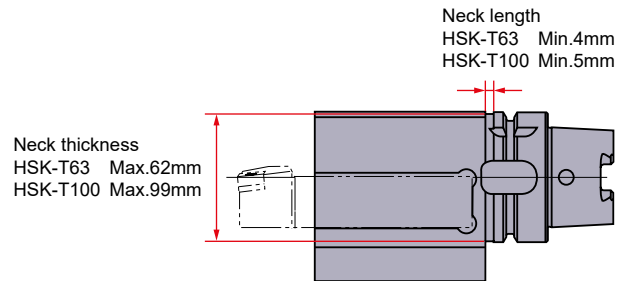

HSK-T turning tool standard (Example)

Improved keyway tolerance

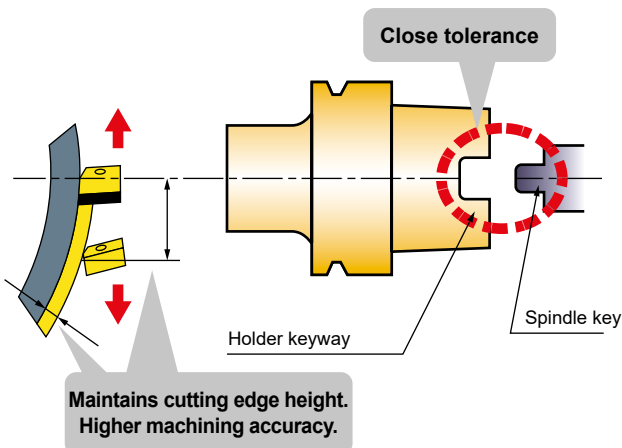

Tolerance comparison (Example) (mm)

	12.2	12.3	12.4	12.5	12.6
HSK A63		12.25	12.35	12.58	
		Key tolerance 0.10			
		Minimum clearance 0.15			
			0.08		
			12.5		
			Keyway tolerance		
			0.33 Maximum clearance		
HSK T63		12.385	12.41	12.46	
		Minimum clearance 0.015			
			0.025		
			0.035		
			12.425		
			Keyway tolerance		
			0.075 Maximum clearance		

High accuracy and rigidity HSK-T type tooling system developed for use on multi-task machines.

Straight type tools suitable for use on multi-task machines

Avoid workpiece interference with improved tool accessibility.

By tilting the machines B spindle (main axis of the tool) at 45 deg, interference between the spindle, holder, workpiece and chuck can be avoided.

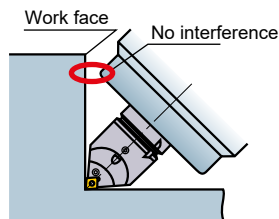

Improve centreline height by positioning the cutting edge at the centre of the spindle.

Increased stability and accuracy can be achieved because the cutting edge centreline height is not affected by the gap between the spindle and the key.

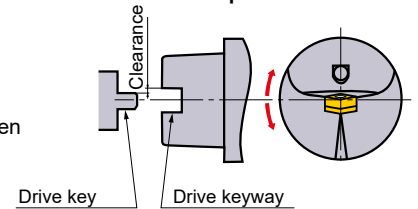

New one-action type double clamp series

The double clamp mechanism offers high rigidity, accuracy and reliability for secure insert clamping. Making it suitable for difficult to machine materials such as stainless and heat resistant alloys.



Handed type for turning and facing



Straight type for turning and facing



For turning, facing and boring

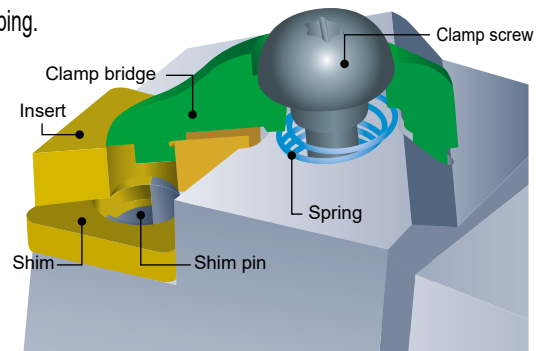

3 on 1 tool for process and tool consolidation

3 turning inserts of the same geometry can be installed on a single tool.

The same type of inserts can be installed for quick tool changes.

Different types of inserts can be installed for different applications (roughing, semi finishing and finishing)

Different grade inserts can be installed to cover various types of workpieces.



New HSK-T100 size for large workpieces

Larger tool holder sizes for high efficiency machining.

Square shank holder type



Boring bar / Drill type



Sleeve







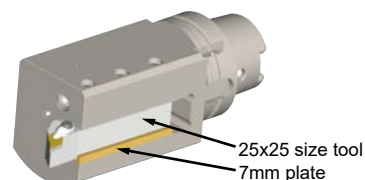





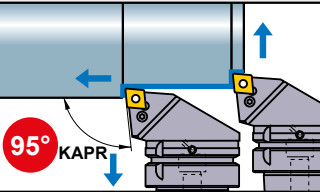

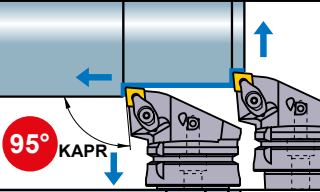

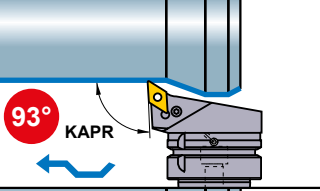
A single tool can be used with different sized tool holders.

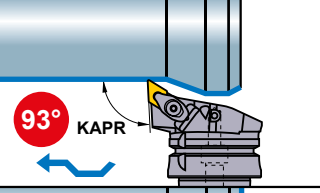

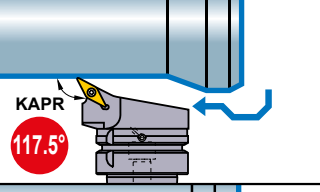

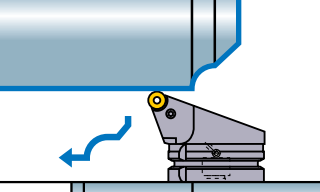

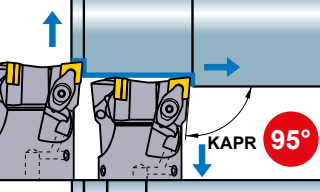

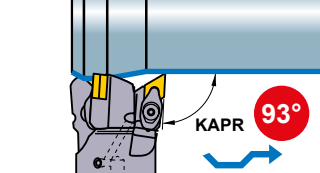

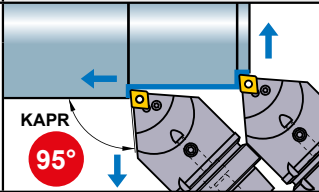
- Available for use with JIS B4126 (ISO 5610) 32 x 32 and 32 x 25 tools.
- Possible to fit a 25 x 25 tool by using a 7mm plate.
- *Plate not supplied.

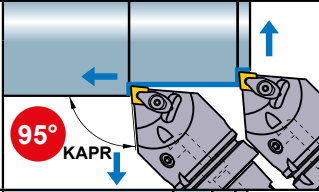

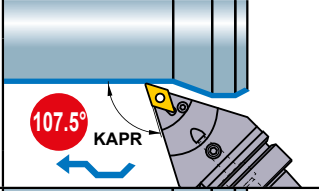
CLASSIFICATION OF HSK-T TOOLS

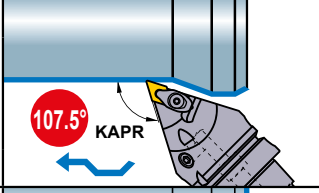
EXTERNAL TURNING • FACING • COPYING

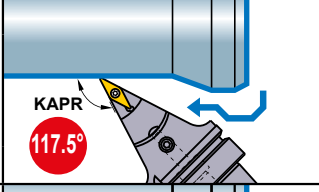

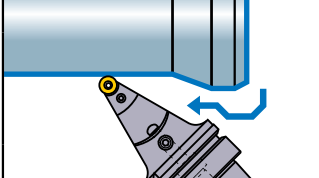
Order Number	Geometry
H63TH-PCLNR/L-DX12  → H006	
H63TH-DCLNR/L-DX12  → H006	
H63TH-PDJNR/L-DX15  → H009	
H63TH-DDJNR/L-DX15  → H009	
H63TH-SVPBR/L-DX16  → H013	
H63TH-PRGCR/L-DX12  → H012	
H63TH-DCLNL-L12-3  → H008	
H63TH-DDJNL-L15-3  → H011	

Order Number	Geometry
H63TH-PCMNN-H/L12  → H007	
H63TH-DCMNN-H/L12  → H007	
H63TH-PDNNN-H/L15  → H010	
H63TH-DDNNN-H/L15  → H010	
H63TH-SVVBH-H/L16  → H013	
H63TH-PRDCN-H/L12  → H012	

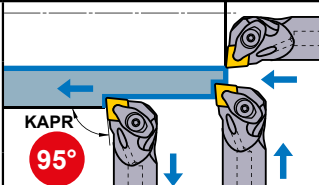



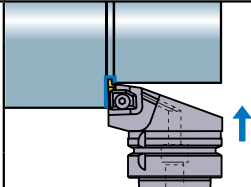

EXTERNAL TURNING • FACING • BORING

Order Number	Geometry
H63TH-A25KDCLNR/L12 H63TH-A32LDCLNR/L12  → H008	

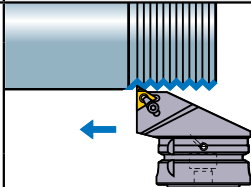

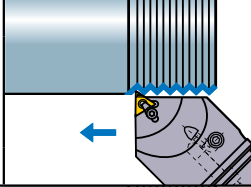

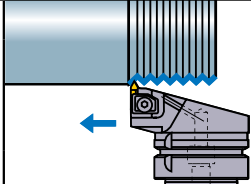
GROOVING

Order Number	Geometry
H63TH-MGHR/L-DX43    H014	







THREADING

Order Number	Geometry
H63TH-MMTER-DX16    H016	
H63TH-MMTENR-H/L16    H016	
H63TH-MTHR/L-DX43    H017	

EXTERNAL TURNING TOOL HOLDERS

Order Number	Holder
H63TH-EV2525R/L-112   H019	
H100TH-EV3232R/L-180   H019	
H63TH-EN2525R/L-115  *1  H020	
H100TH-EN3232R/L-130  *1  H020	
H63TH-EV2020R/L-105-3   H021	

BORING BAR HOLDERS

Order Number	Holder
H63TH-B   H021	
H100TH-B   H022	
SL32-90 (Sleeve)  *2  H022	

Note 1) The HSK63A shank type has a built-in coolant pipe for installation.

*1 Mitsubishi Materials is licensed for production and distribution of these tools from MORI SEIKI CO., LTD under Patent No.3720202.

*2 The SL32-90 sleeve is only for use with H100TH-B32-135.







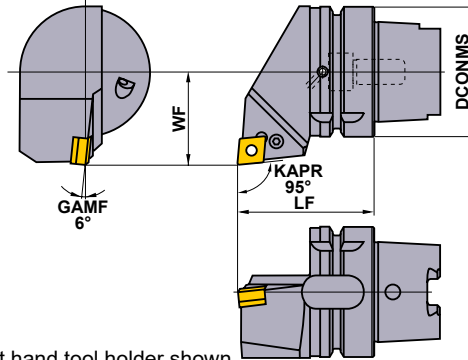
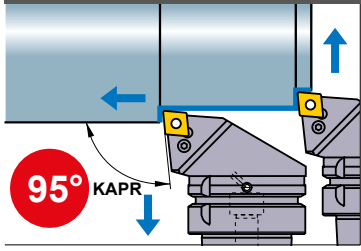

HSK-T SYSTEM





PCLN

External turning • Facing



Right hand tool holder shown.

Finish	Light	Medium
FP  (12)	LP  (12)	MP  (12)
Medium MK  (12)	Medium Standard  (12)	Medium— Rough RP  (12)
Stainless MM  (12)	PCBN  (12)	

Order Number	Stock		Insert Number	Dimensions (mm)			*2 WT (kg)				 *1		
	R	L		DCONMS	LF	WF		Shim	Shim Pin	Clamp Lever	Clamp Screw	Wrench	
H63TH-PCLNR/L-DX12	●	●	CN○A CN○G CN○M	1204	63	65	45	1.3	LLSCN42	LLP14	LLCL14	LLCS108	HKY30R

*1 Clamp Torque (N • m) : LLCS108=3.3

*2 WT : Tool Weight







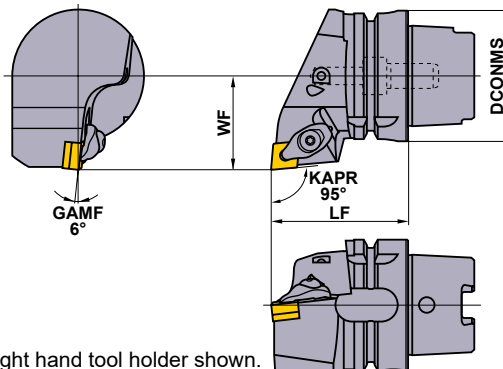
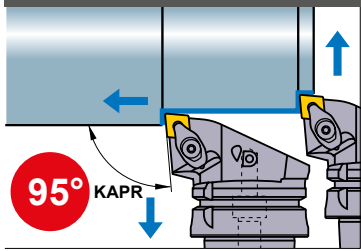

Note 1) Dimensions shown for insert corner RE 0.8.







DCLN

External turning • **DOUBLE CLAMP** type Facing



Right hand tool holder shown.

Finish	Light	Medium
FP  (12)	LP  (12)	MP  (12)
Medium MK  (12)	Medium Standard  (12)	Medium— Rough RP  (12)
Stainless MM  (12)	PCBN  (12)	

Order Number	Stock		Insert Number	Dimensions (mm)			*2 WT (kg)					 *1		
	R	L		DCONMS	LF	WF		Shim	Shim Pin	Clamp Bridge	Spring	Clamp Screw	Wrench	
H63TH-DCLNR/L-DX12	●	●	CN○A CN○G CN○M	1204	63	65	45	1.3	LLSCN42	LLP14	DCK2613	DCS1	DC0621T	TKY20F

*1 Clamp Torque (N • m) : DC0621T=5.0

*2 WT : Tool Weight









Note 1) Dimensions shown for insert corner RE 0.8.







● : Inventory maintained.

PCLN type inserts	> A098—A104
DCLN type inserts	> A098—A104
PCBN & PCD inserts	> B036—B038, B064
RECOMMENDED CUTTING CONDITIONS	> A074

PCMN

External turning • Facing

Finish	Light	Medium
FP  (12)	LP  (12)	MP  (12)
Medium MK  (12)	Medium Standard  (12)	Medium— Rough RP  (12)
Stainless MM  (12)	PCBN  (12)	

Order Number	Stock	Insert Number	Dimensions (mm)		*2 WT (kg)						
			DCONMS	LF		Shim	Shim Pin	Clamp Lever	Clamp Screw	Plug	Wrench
H63TH-PCMNN-H12	●	CN \circ A CN \circ G CN \circ M	63	100	1.7	LLSCN42	LLP14	LLCL14	LLCS108	HGM-PT1/8	HKY30R
H63TH-PCMNN-L12	●		63	140	2.7	LLSCN42	LLP14	LLCL14	LLCS108	HGM-PT1/8	HKY30R









*1 Clamp Torque (N • m) : LLCS108=3.3







*2 WT : Tool Weight

Note 1) Dimensions shown for insert corner RE 0.8.

DCMN

External turning • DOUBLE CLAMP type Facing

Finish	Light	Medium
FP  (12)	LP  (12)	MP  (12)
Medium MK  (12)	Medium Standard  (12)	Medium— Rough RP  (12)
Stainless MM  (12)	PCBN  (12)	

Order Number	Stock	Insert Number	Dimensions (mm)		*2 WT (kg)						
			DCONMS	LF		Shim	Shim Pin	Clamp Bridge	Spring	Clamp Screw	Wrench
H63TH-DCMNN-H12	●	CN \circ A CN \circ G CN \circ M	63	100	1.7	LLSCN42	LLP14	DCK2613	DCS1	DC0621T	TKY20F
H63TH-DCMNN-L12	●		63	140	2.7	LLSCN42	LLP14	DCK2613	DCS1	DC0621T	TKY20F

*1 Clamp Torque (N • m) : DC0621T=5.0

*2 WT : Tool Weight

Note 1) Dimensions shown for insert corner RE 0.8.

H
HSK-T TOOLS

PCMN type inserts	> A098—A104
DCMN type inserts	> A098—A104
PCBN & PCD inserts	> B036—B038, B064

RECOMMENDED CUTTING CONDITIONS	> A074
SPARE PARTS	> N001
TECHNICAL DATA	> P001

HSK-T SYSTEM

DCLN External turning • Facing **DOUBLE CLAMP type**

Finish	Light	Medium
FP (12)	LP (12)	MP (12)
Medium MK (12)	Medium Standard (12)	Medium— Rough RP (12)
Stainless MM (12)	PCBN (12)	

Left hand tool holder only.

Order Number	Stock		Insert Number	Dimensions (mm)			*2 WT (kg)	*1						
	L			DCONMS	LF	WF		Shim	Shim Pin	Clamp Bridge	Spring	Clamp Screw	Wrench	
H63TH-DCLNL-L12-3	●		CN○A CN○G CN○M	1204	63	140	30	2.2	LLSCN42	LLP14	DCK2613	DCS1	DC0621T	TKY20F

*1 Clamp Torque (N • m) : DC0621T=5.0

*2 WT : Tool Weight

Note 1) Dimensions shown for insert corner RE 0.8.

HSK-T TOOLS

DCLN External turning • Facing • Boring **DOUBLE CLAMP type**

Finish	Light	Medium
FP (12)	LP (12)	MP (12)
Medium MK (12)	Medium Standard (12)	Medium— Rough RP (12)
Stainless MM (12)	PCBN (12)	

Right hand tool holder shown.

Order Number	Stock		Insert Number	Dimensions (mm)						*2 WT (kg)	*1						
	R	L		DCONMS	LF	LU	WF	GAMF	DMIN		Shim	Shim Pin	Clamp Bridge	Spring	Clamp Screw	Wrench	
H63TH-A25KDCLNR/L12	●	●	CN○A CN○G CN○M	1204	63	125	82	17	11°	32	1.1	LLSCP42	LLP14	DCK2613	DCS1	DC0621T	TKY20F
H63TH-A32LDCLNR/L12	●	●	CN○A CN○G CN○M	1204	63	140	100	22	13°	40	1.4	LLSCN42	LLP14	DCK2613	DCS1	DC0621T	TKY20F

*1 Clamp Torque (N • m) : DC0621T=5.0

*2 WT : Tool Weight

Note 1) Dimensions shown for insert corner RE 0.8.

● : Inventory maintained.

DCLN type inserts	> A098—A104
PCBN & PCD inserts	> B036—B038, B064
RECOMMENDED CUTTING CONDITIONS	> A074

PDJN

External turning • Copying

Right hand tool holder shown.

Finish	Light	Medium
FP (15)	LP (15)	MP (15)
Medium MK (15)	Medium-Rough RP (15)	Stainless MM (15)
G Class R/L (15)	PCBN (15)	

Order Number	Stock		Insert Number	Dimensions (mm)			*3 WT (kg)	*2					
	R	L		DCONMS	LF	WF		Shim	Shim Pin	Clamp Lever	Clamp Screw	Wrench	
H63TH-PDJNR/L-DX15	●	●	DNOA DNOG DNOM DNMX	1504	63	65	45	1.2	LLSDN43 (LLSDN42)	LLP14	LLCL24	LLCS108	HKY30R

*1 Clamp Torque (N • m) : LLCS108=3.3

*2 Please use shim no. LLSDN42 with 6.35mm thick inserts. When using 6.35mm thick inserts, the shim should be ordered separately.

*3 WT : Tool Weight

Note 1) Dimensions shown for insert corner RE 0.8.

DDJN

External turning • Copying

DOUBLE CLAMP type

Right hand tool holder shown.

Finish	Light	Medium
FP (15)	LP (15)	MP (15)
Medium MK (15)	Medium-Rough RP (15)	Stainless MM (15)
G Class R/L (15)	PCBN (15)	

Order Number	Stock		Insert Number	Dimensions (mm)			*3 WT (kg)	*2						
	R	L		DCONMS	LF	WF		Shim	Shim Pin	Clamp Bridge	Spring	Clamp Screw	Wrench	
H63TH-DDJNR/L-DX15	●	●	DNOA DNOG DNOM DNMX	1504	63	65	45	1.2	LLSDN43 (LLSDN42)	LLP24	DCK2613	DCS1	DC0621T	TKY20F

*1 Clamp Torque (N • m) : DC0621T=5.0

*2 Please use shim no. LLSDN42 with 6.35mm thick inserts. When using 6.35mm thick inserts, the shim should be ordered separately.

*3 WT : Tool Weight

Note 1) Dimensions shown for insert corner RE 0.8.

H
HSK-T TOOLS

PDJN type inserts	> A105–A111
DDJN type inserts	> A105–A111
PCBN & PCD inserts	> B039–B042, B064

RECOMMENDED CUTTING CONDITIONS	> A074
SPARE PARTS	> N001
TECHNICAL DATA	> P001

HSK-T SYSTEM

PDNN

External turning • Copying

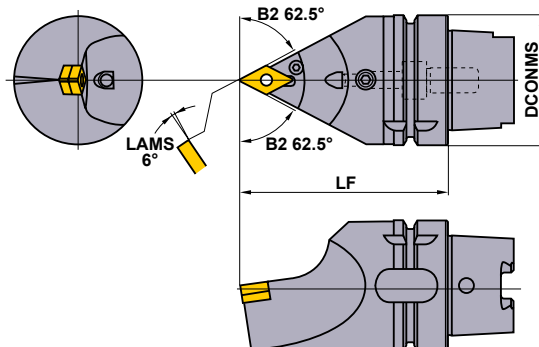
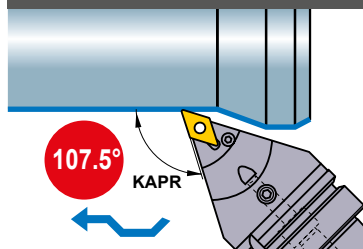

Finish	Light	Medium
FP  (15)	LP  (15)	MP  (15)
Medium MK  (15)	Medium-Rough RP  (15)	Stainless MM  (15)
G Class R/L  (15)	PCBN  (15)	

Order Number	Stock	Insert Number	Dimensions (mm)		*3 WT (kg)	*2						
			DCONMS	LF		Shim	Shim Pin	Clamp Lever	Clamp Screw	Plug	Wrench	
H63TH-PDNNN-H15	●	DN \circ A DN \circ G DN \circ M	1504 \circ	63	100	1.6	LLSDN43 (LLSDN42)	LLP14	LLCL24	LLCS108	HGM-PT1/8	HKY30R
H63TH-PDNNN-L15	●			63	140	2.5	LLSDN43 (LLSDN42)	LLP14	LLCL24	LLCS108	HGM-PT1/8	HKY30R

*1 Clamp Torque (N • m) : LLCS108=3.3

*2 Please use shim no. LLSDN42 with 6.35mm thick inserts. When using 6.35mm thick inserts, the shim should be ordered separately.







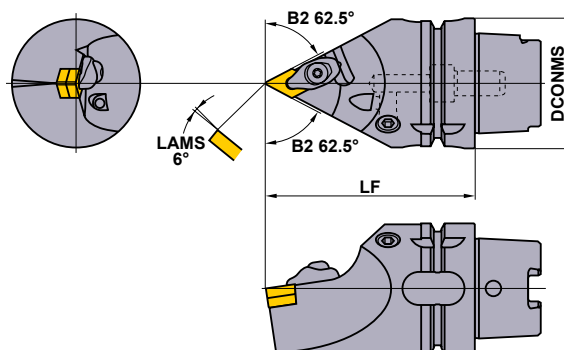
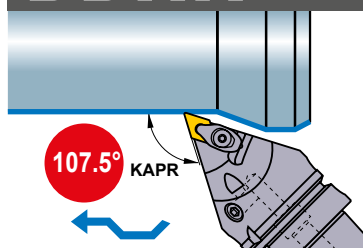

*3 WT : Tool Weight

Note 1) Dimensions shown for insert corner RE 0.8.

DDNN

External turning • Copying **DOUBLE CLAMP type**



Finish	Light	Medium
FP  (15)	LP  (15)	MP  (15)
Medium MK  (15)	Medium-Rough RP  (15)	Stainless MM  (15)
G Class R/L  (15)	PCBN  (15)	

Order Number	Stock	Insert Number	Dimensions (mm)		*3 WT (kg)	*2						
			DCONMS	LF		Shim	Shim Pin	Clamp Bridge	Spring	Clamp Screw	Wrench	
H63TH-DDNNN-H15	●	DN \circ A DN \circ G DN \circ M	1504 \circ	63	100	1.6	LLSDN43 (LLSDN42)	LLP24	DCK2613	DCS1	DC0621T	TKY20F
H63TH-DDNNN-L15	●			63	140	2.5	LLSDN43 (LLSDN42)	LLP24	DCK2613	DCS1	DC0621T	TKY20F

*1 Clamp Torque (N • m) : DC0621T=5.0

*2 Please use shim no. LLSDN42 with 6.35mm thick inserts. When using 6.35mm thick inserts, the shim should be ordered separately.

*3 WT : Tool Weight

Note 1) Dimensions shown for insert corner RE 0.8.

HSK-T TOOLS

H

● : Inventory maintained.

PDNN type inserts	> A105–A111
DDNN type inserts	> A105–A111
PCBN & PCD inserts	> B039–B042, B064
RECOMMENDED CUTTING CONDITIONS	> A074

DDJN

External turning • Facing DOUBLE CLAMP type

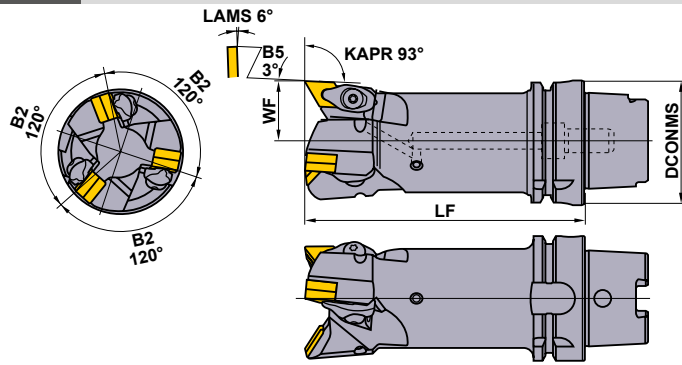
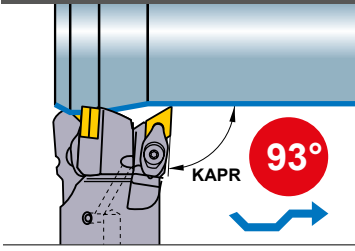

Left hand tool holder only.

Finish		Light	
FP	LP		
(15)	(15)		
Medium		Medium	
MP	MK		
(15)	(15)		
Medium—Rough		Stainless	
RP	MM		
(15)	(15)		

Order Number	Stock	Insert Number	Dimensions (mm)			*3 WT (kg)	*2						
			DCONMS	LF	WF		Shim	Shim Pin	Clamp Bridge	Spring	Clamp Screw	Wrench	
H63TH-DDJNL-L15-3	●	DN○A DN○G DN○M DNMX	1504	63	140	30	2.2	LLSDN43 (LLSDN42)	LLP24	DCK2613	DCS1	DC0621T	TKY20F

*1 Clamp Torque (N • m) : DC0621T=5.0

*2 Please use shim no. LLSDN42 with 6.35mm thick inserts. When using 6.35mm thick inserts, the shim should be ordered separately.

*3 WT : Tool Weight

Note 1) Dimensions shown for insert corner RE 0.8.

DDJN type inserts	> A105—A111
PCBN & PCD inserts	> B039—B042, B064
RECOMMENDED CUTTING CONDITIONS	> A074

SPARE PARTS	> N001
TECHNICAL DATA	> P001

HSK-T SYSTEM

PRGC

External turning • Facing • Copying

Medium

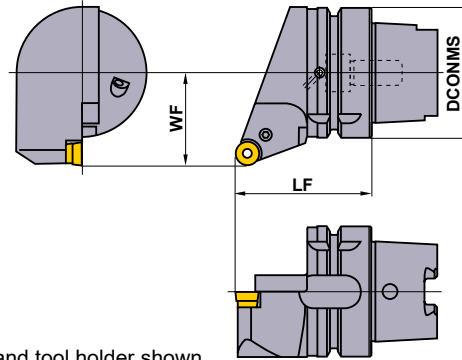
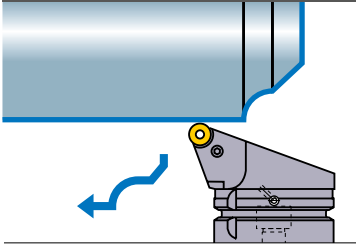

Right hand tool holder shown.

Order Number	Stock		Insert Number	Dimensions (mm)			*2 WT (kg)				*1	
	R	L		DCONMS	LF	WF		Shim	Shim Pin	Clamp Lever	Clamp Screw	Wrench
H63TH-PRGCR/L-DX12	●	●	RCMX 1204M0	63	65	45	1.2	LLSRN123	LLP13	LLCL112	LLCS106	HKY25R

*1 Clamp Torque (N • m) : LLCS106=2.2

*2 WT : Tool Weight

PRDC

External turning • Facing • Copying

Medium

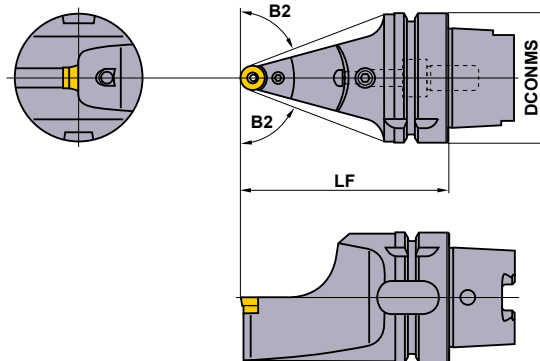
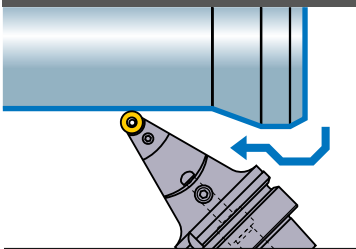

Order Number	Stock		Insert Number	Dimensions (mm)			*2 WT (kg)				*1		
	R	L		DCONMS	LF	B2		Shim	Shim Pin	Clamp Lever	Clamp Screw	Plug	Wrench
H63TH-PRDCN-H12	●	●	RCMX 1204M0	63	100	69°	1.4	LLSRN123	LLP13	LLCL112	LLCS106	HGM-PT1/8	HKY25R
H63TH-PRDCN-L12	●	●		63	140	75°	2.3	LLSRN123	LLP13	LLCL112	LLCS106	HGM-PT1/8	HKY25R

*1 Clamp Torque (N • m) : LLCS106=2.2

*2 WT : Tool Weight

RECOMMENDED CUTTING CONDITIONS

	Work Material	Hardness	Cutting Mode	Breaker	Grade	Cutting Speed (m/min)
P	Mild Steel	≤180HB	Medium Cutting	Standard	UE6110	205–350
	Carbon Steel Alloy Steel	180HB–350HB	Medium Cutting	Standard	UE6110	150–260
M	Stainless Steel	≤200HB	Medium Cutting	Standard	US735	70–130

● : Inventory maintained.

PRGC type inserts > A154

PRDC type inserts > A154

SVPB

Facing • Copying

Right hand tool holder shown.

Finish		Light	
R/L-F	SV		
		(16)	(16)
Medium		Medium	
MV	MP		
		(16)	(16)
PCBN			
		(16)	

Order Number	Stock		Insert Number	Dimensions (mm)				*2 WT (kg)					
	R	L		DCONMS	LF	WF	WF2		Shim	Shim Pin	Clamp Screw	Wrench	
H63TH-SVPBR/L-DX16	●	●	VB[○]T VB[○]W	1604	63	65	45	3.8	1.1	SPSVN32	BCP141	TS35D	TKY15F

*1 Clamp Torque (N • m) : TS35D=3.5

*2 WT : Tool Weight

Note 1) Dimensions shown for insert corner RE 0.8.

SVVB

Facing • Copying

Finish		Light	
R/L-F	SV		
		(16)	(16)
Medium		Medium	
MV	MP		
		(16)	(16)
PCBN			
		(16)	

Order Number	Stock		Insert Number	Dimensions (mm)			*2 WT (kg)						
	R	L		DCONMS	LF	B2		Shim	Shim Pin	Clamp Screw	Plug	Wrench	
H63TH-SVVBH-H16	●	●	VB[○]T VB[○]W	1604	63	100	66.5°	1.3	SPSVN32	BCP141	TS35D	HGM-PT1/8	TKY15F
H63TH-SVVBH-L16	●	●	VB[○]T VB[○]W	1604	63	140	72.5°	2.2	SPSVN32	BCP141	TS35D	HGM-PT1/8	TKY15F

*1 Clamp Torque (N • m) : TS35D=3.5

*2 WT : Tool Weight

Note 1) Dimensions shown for insert corner RE 0.8.

RECOMMENDED CUTTING CONDITIONS

Work Material	Hardness	Cutting Mode	Breaker	Grade	Cutting Speed (m/min)	
P	Mild Steel	≤180HB	Finish Cutting	F	AP25N	250 (150–300)
		Medium Cutting	MP	MC6015	200 (150–250)	
	Carbon Steel Alloy Steel	180HB–350HB	Finish Cutting	F	AP25N	210 (150–260)
			Medium Cutting	MP	MC6025	170 (120–210)
M	Stainless Steel	≤200HB	Medium Cutting	MM	MP7035	100 (70–120)
K	Cast Iron	Tensile Strength ≤350MPa	Medium Cutting	MK	MC5015	170 (140–200)

SVPB type inserts > A164–A166

SVVB type inserts > A164–A166

PCBN inserts > B059

SPARE PARTS > N001

TECHNICAL DATA > P001

H

HSK-T TOOLS

H013

HSK-T SYSTEM

MG

Grooving

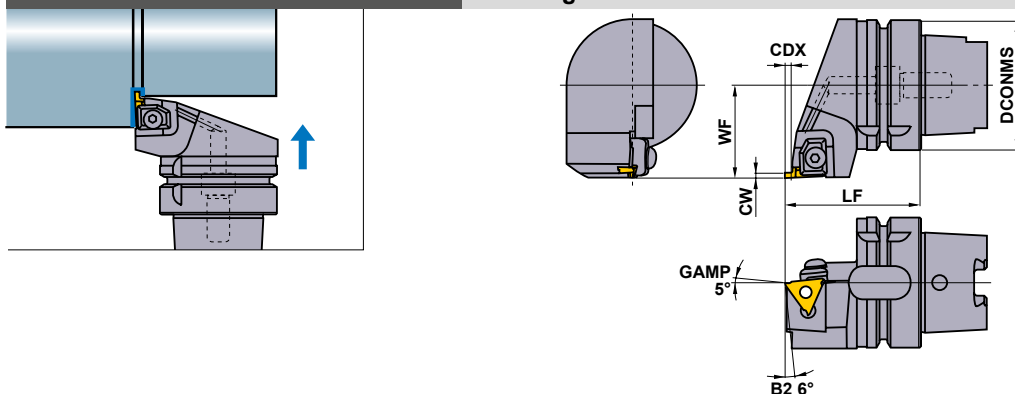

Order Number	Stock		Insert Number	Dimensions (mm)					*2 WT (kg)	*1			
	R	L		DCOMMS	CW	CDX	LF	WF		Clamp Bridge	Clamp Screw	Spring	Wrench
H63TH-MGHR/L-DX4315	★	★	MGTR/L 43125 43470	63	1.25	1.2	65	45	1.2	MTK1R/L	HBH06020	MES3	HKY40R
				63	1.45	1.5	65	45	1.2				
H63TH-MGHR/L-DX4323	★	★		63	1.5 ≤ CW ≤ 2.3	3	65	45	1.2				
H63TH-MGHR/L-DX4333	★	★		63	2.3 < CW ≤ 3.3	4.5	65	45	1.2				
				63	3.3 < CW ≤ 4.7	4.5	65	45	1.2				

*1 Clamp Torque (N · m) : HBH06020=7.0

*2 WT : Tool Weight

H

HSK-T TOOLS

RECOMMENDED CUTTING CONDITIONS

	Work Material	Hardness	Grade	Cutting Speed (m/min)	Feed (mm/rev)
P	Carbon Steel Alloy Steel	180—350HB	VP20MF	120 (100—140)	0.10 (0.03—0.18)
			NX2525	130 (100—160)	0.12 (0.03—0.2)
M	Stainless Steel	≤200HB	VP20MF	120 (100—140)	0.10 (0.03—0.18)
K	Cast Iron	Tensile Strength ≤350MPa	VP20MF	120 (100—140)	0.10 (0.03—0.18)

● : Inventory maintained. ★ : Inventory maintained in Japan.

(10 inserts in one case) (PCBN inserts are available in 1 piece in one case.)

INSERTS

Order Number	Stock						Dimensions (mm)					Geometry	
	Coated		Cermet		Carbide		CW	CDX	IC	W1	RER/L		LE
	VP20MF		NX2525		UTi20T								
	R	L	R	L	R	L							
MGTR/L43125	★	★	★	★	●	●	1.25	1.2	12.7	4.76	0.2	2.7	MGTR/L...
MGTR/L43145	★	★		★	●	★	1.45	1.5	12.7	4.76	0.2	—	
MGTR/L43150	★	★	★	●	●	●	1.5	3	12.7	4.76	0.2	2.7	
MGTR/L43175	★	★	★	★	●	●	1.75	3	12.7	4.76	0.2	—	
MGTR/L43200	★	★	★	●	●	●	2	3	12.7	4.76	0.2	2.7	
MGTR/L43230	★	★	●	★	●	●	2.3	3	12.7	4.76	0.2	—	
MGTR/L43250	★	★	★	★	●	●*	2.5	4.5	12.7	4.76	0.3	2.7	
MGTR/L43260	★	★	★		●	●	2.6	4.5	12.7	4.76	0.3	—	
MGTR/L43270	★	★			●	★	2.7	4.5	12.7	4.76	0.3	—	
MGTR/L43280		★		★	●	●	2.8	4.5	12.7	4.76	0.3	—	
MGTR/L43300	★	★	★	★	●	●*	3	4.5	12.7	4.76	0.3	2.7	
MGTR/L43320	★				●	●	3.2	4.5	12.7	4.76	0.3	—	
MGTR/L43330		★		★	●	●	3.3	4.5	12.7	4.76	0.3	—	
MGTR/L43350	★	★	★	★	●	●*	3.5	4.5	12.7	4.76	0.3	2.7	
MGTR/L43400	★	★	★		●	●*	4	4.5	12.7	4.76	0.3	2.7	
MGTR/L43420	★	★	★		●	●	4.2	4.5	12.7	4.76	0.4	—	
MGTR/L43430	★	★	★		●	●	4.3	4.5	12.7	4.76	0.4	—	
MGTR/L43450	★	★	●	★	●	●	4.5	4.5	12.7	4.76	0.4	—	
MGTR/L43470	★	★	★	★	●	★	4.7	4.5	12.7	4.76	0.4	—	



HSK-T TOOLS

HSK-T SYSTEM

MMTE

Threading

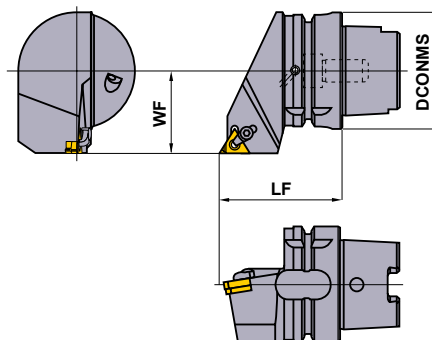
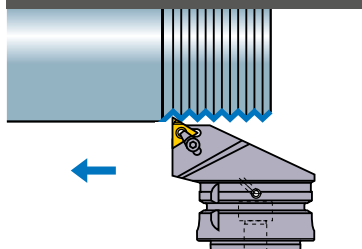

Right hand tool holder only.

Order Number	Stock R	Insert Number	Dimensions (mm)			*2 WT (kg)		*1			*1	
			DCONMS	LF	WF							
H63TH-MMTER-DX16	★	MMT16ER	63	65	45	1.2	SETK51	SETS51	CR4	CTE32TP15	HFC03008	TKY15F HKY20R

*1 Clamp Torque (N • m) : SETS51=3.5, HFC03008=1.5

*2 WT : Tool Weight

MMTEN

Threading

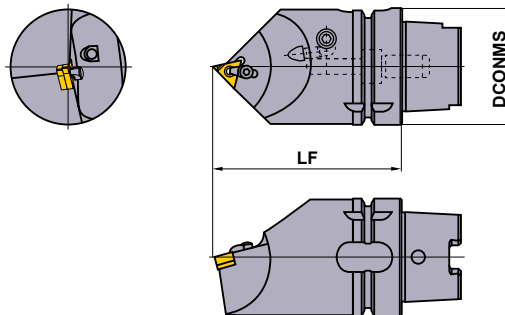
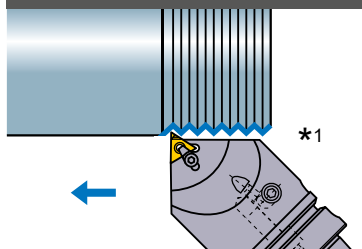

Tool holder for right hand insert only.

Order Number	Stock	Insert Number	Dimensions (mm)			*3 WT (kg)		*2			*2		
			DCONMS	LF									
H63TH-MMTENR-H16	★	MMT16ER	63	100		1.7	SETK51	SETS51	CR4	CTE32TP15	HFC03008	HGM-PT1/8	TKY15F HKY20R
H63TH-MMTENR-L16	★		63	140		2.7	SETK51	SETS51	CR4	CTE32TP15	HFC03008	HGM-PT1/8	TKY15F HKY20R

*1 For use with B axis tilted at 45 degrees.



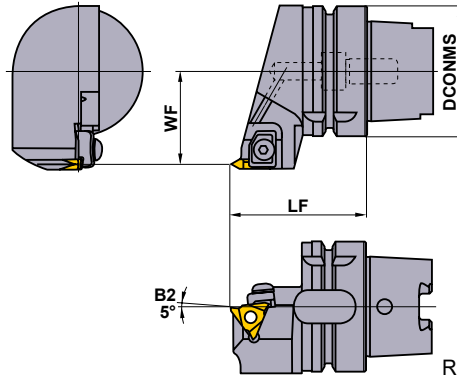
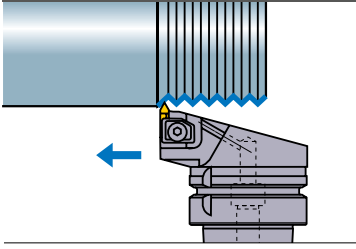

*2 Clamp Torque (N • m) : SETS51=3.5, HFC03008=1.5

*3 WT : Tool Weight

★ : Inventory maintained in Japan.

MT**Threading**

Right hand tool holder shown.

Order Number	Stock		Insert Number	Dimensions (mm)			*2 WT (kg)					
	R	L		DCONMS	LF	WF		Clamp Bridge	Clamp Screw	Spring	Wrench	
H63TH-MTHR/L-DX43	★	★	MTTR/L	43	63	65	45	1.2	MTK1R/L	HBH06020	MES3	HKY40R

*1 Clamp Torque (N • m) : HBH06020=7.0

*2 WT : Tool Weight

H

HSK-T TOOLS

RECOMMENDED CUTTING CONDITIONS





	Work Material	Hardness	Grade	Cutting Speed (m/min)
P	Mild Steel	≤180HB	UP20M	140 (100–180)
			UTi20T	120 (100–150)
	Carbon Steel Alloy Steel	180HB–350HB	UP20M	120 (100–150)
			UTi20T	100 (70–120)
M	Stainless Steel	≤200HB	UP20M	120 (80–150)
			UTi20T	100 (70–130)
K	Cast Iron	Tensile Strength ≤350MPa	UP20M	80 (60–100)
			UTi20T	80 (60–100)
			HTi10	100 (70–130)

APPLICABLE INSERT > H018
SPARE PARTS > N001
TECHNICAL DATA > P001

H017

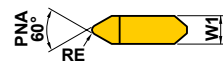
HSK-T SYSTEM

INSERTS

Type	Order Number	Class	Coated				ISO Pitch mm (thread/inch)	Dimensions (mm)			Geometry
			UP20M	Cermet	Carbide			IC	W1	RE	
General 60°	MTTR436000	G		●	●		-0.8	12.7	4.76	0	MTTR/L(60°) (G Class)   Right hand insert shown.
	MTTR436001	G	★	●	●	★	1.0-1.75	12.7	4.76	0.1	
	MTTL436001	G	★		●	★	1.0-1.75	12.7	4.76	0.1	
	MTTR436002	G	★	●	●	★	2.0-2.5	12.7	4.76	0.2	
	MTTL436002	G		●	●		2.0-2.5	12.7	4.76	0.2	
	MTTR436003	G	★	●	●	★	3.0-3.5	12.7	4.76	0.3	
	MTTL436003	G		●	●		3.0-3.5	12.7	4.76	0.3	
	MTTR436004	G		●	●		4.0-4.5	12.7	4.76	0.4	
General 55°	MTTR435501	G		●	★		(28-10)	12.7	4.76	0.1	MTTR(55°) (G Class)   Right hand insert shown.
	MTTR435502	G		●	●		(16-8)	12.7	4.76	0.2	
	MTTR435503	G		●	●		(11-8)	12.7	4.76	0.3	

STANDARD OF DEPTH OF CUT ● METRIC SCREW THREAD

Unit : mm

- The chart on the right shows the cutting depths when machining external ISO metric screw threads.
- When using cermet grades or cutting stainless steel, please increase the number of passes by 2-3 times.

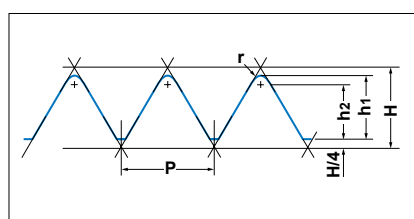

P (Pitch)	0.75	1.00	1.25	1.50	1.75	2.00	2.50	3.00	3.50	4.00	4.50	
h1	0.46	0.61	0.77	0.92	1.07	1.23	1.53	1.84	2.15	2.45	2.76	
h2	0.35	0.47	0.59	0.70	0.82	0.94	1.17	1.41	1.65	1.87	2.11	
r (Nose Radius)	0.11	0.14	0.18	0.22	0.25	0.29	0.36	0.43	0.50	0.58	0.65	
Number of Passes	1	0.18	0.20	0.20	0.25	0.25	0.25	0.30	0.30	0.35	0.35	0.40
	2	0.13	0.15	0.18	0.20	0.20	0.25	0.25	0.25	0.30	0.30	0.35
	3	0.10	0.10	0.12	0.15	0.20	0.20	0.20	0.25	0.25	0.25	0.30
	4	0.05	0.10	0.12	0.15	0.15	0.15	0.20	0.20	0.20	0.25	0.25
	5		0.06	0.10	0.10	0.12	0.15	0.15	0.20	0.20	0.25	0.25
	6			0.05	0.07	0.10	0.10	0.10	0.15	0.20	0.20	0.20
	7					0.05	0.08	0.10	0.15	0.15	0.20	0.20
	8						0.05	0.10	0.10	0.15	0.15	0.15
	9							0.08	0.10	0.10	0.15	0.15
	10							0.05	0.09	0.10	0.10	0.15
	11								0.05	0.10	0.10	0.10
	12									0.05	0.10	0.10
	13										0.05	0.10
	14											0.06

Note 1) The first pass causes a high load on the cutting edge.
 In order to avoid damage, restrict the depth of cut to a maximum of 0.4-0.5mm.

EXTERNAL TURNING TOOL HOLDERS External turning • Facing

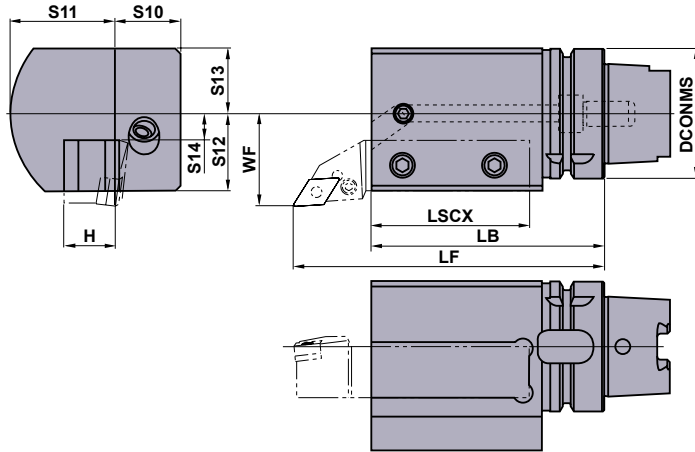

■ This holder is for 25×25 size tools.
Please shorten the tool as shown below before use.

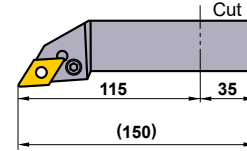

Right hand tool holder shown.

Order Number	Stock		Dimensions (mm)										* WT (kg)			
	R	L	DCONMS	LF	LB	LSCX	H	S10	S11	WF	S14	S12				S13
H63TH-EV2525R/L-112	★	★	63	150	112	77	25	32	53	45	13	38	32	3.9	HSS12025	HGM-PT1/8

* WT : Tool Weight

EXTERNAL TURNING TOOL HOLDERS External turning • Facing

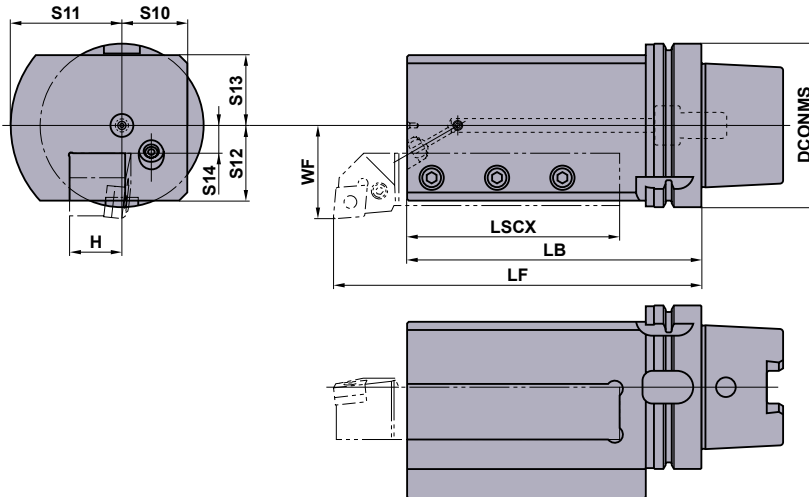

■ This holder is for 32×32 and 32×25 size tools.

Right hand tool holder shown.

Order Number	Stock		Dimensions (mm)										* WT (kg)			
	R	L	DCONMS	LF	LB	LSCX	H	S10	S11	WF	S14	S12				S13
H100TH-EV3232R/L-180	★	★	100	220	180	130	32	40	68	57	17	46	43	11.7	HSS14035	HSS06006

Note 1) Can be used with 32 x 32 and 32 x 25 tool holders. Possible to fit a 25 x 25 tool by using a 7mm plate.

* WT : Tool Weight

HSK-T SYSTEM

EXTERNAL TURNING TOOL HOLDERS External turning • Facing

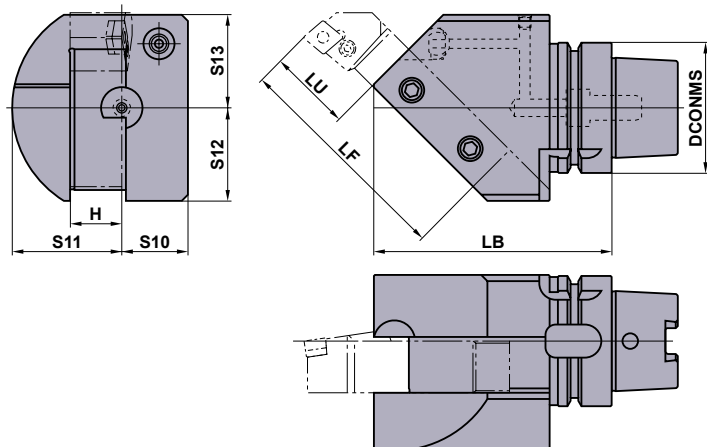

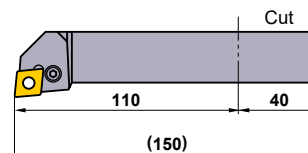

■ This holder is for 25×25 size tools.
Please shorten the tool as shown below before use.



Mitsubishi Materials is licensed to produce and distribute these tools by MORI SEIKI CO., LTD under Patent No.3720202.

Right hand tool holder shown.

Order Number	Stock		Dimensions (mm)									* WT (kg)	 Clamp Screw	 Plug
	R	L	DCONMS	LB	LU	LF	H	S10	S11	S12	S13			
H63TH-EN2525R/L-115	★	★	63	115	40	110	25	32	53	45	45	3.7	HSS12030	HSS06006

* WT : Tool Weight

EXTERNAL TURNING TOOL HOLDERS External turning • Facing

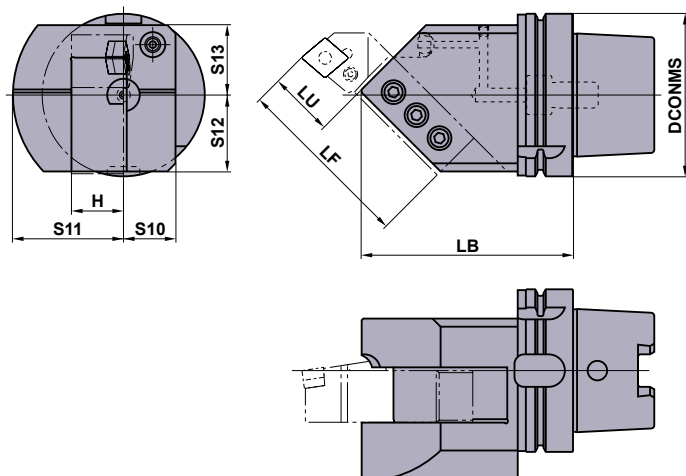

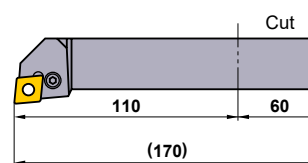

■ This holder is for 32×32 and 32×25 size tools.
Please shorten the tool as shown below before use.



Mitsubishi Materials is licensed to produce and distribute these tools by MORI SEIKI CO., LTD under Patent No.3720202.

Right hand tool holder shown.

Order Number	Stock		Dimensions (mm)									* WT (kg)	 Clamp Screw	 Plug
	R	L	DCONMS	LB	LU	LF	H	S10	S11	S12	S13			
H100TH-EN3232R/L-130	★	★	100	130	40	110	32	32	68	47	43	6.6	HSS14030	HSS06006

Note 1) Can be used with 32 x 32 and 32 x 25 tool holders. Possible to fit a 25 x 25 tool by using a 7mm plate.

* WT : Tool Weight

★ : Inventory maintained in Japan.

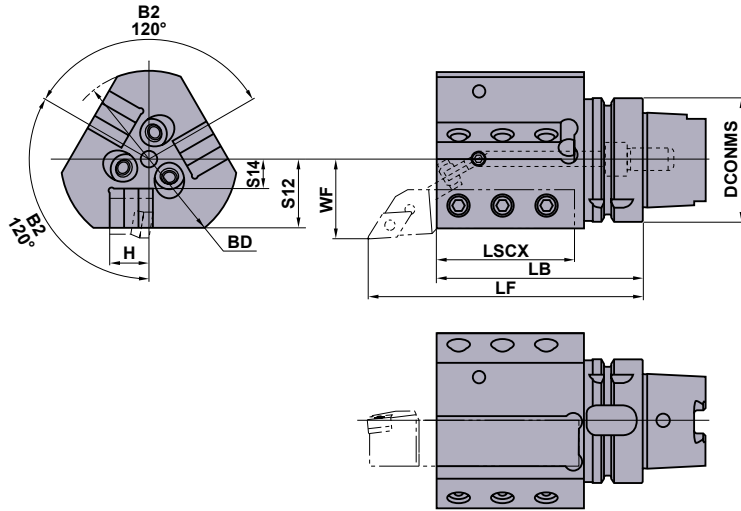

EXTERNAL TURNING TOOL HOLDERS External turning • Facing

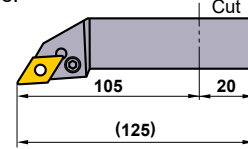

■ This holder is for 20×20 size tools.
Please shorten the tool as shown below before use.





Right hand tool holder shown.

Order Number	Stock		Dimensions (mm)									* WT (kg)	  		
	R	L	DCONMS	LF	LB	LSCX	H	BD	WF	S14	S12		Clamp Screw	Nozzle Plug	Plug
H63TH-EV2020R/L-105-3	★	★	63	140	105	70	20	90	40	15	35	2.9	HSS12030	HSS05012	HSS06006

* WT : Tool Weight

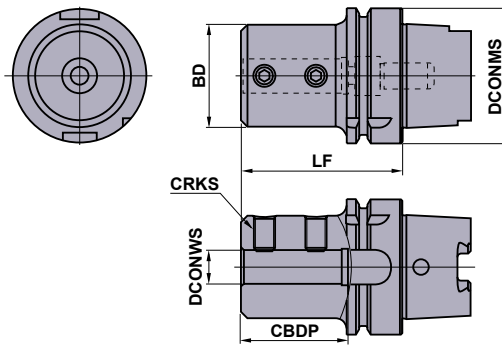
BORING BAR HOLDERS Boring



Order Number	Stock	Dimensions (mm)						* WT (kg)	
		DCONMS	BD	DCONWS	LF	CBDP	CRKS		Clamp Screw
H63TH-B08-65	★	63	28	8	65	40	M8	0.9	HSS08010
H63TH-B10-70	★	63	35	10	70	45	M8	1.0	HSS08012
H63TH-B12-70	★	63	42	12	70	45	M8	1.1	HSS08012
H63TH-B16-75	★	63	48	16	75	50	M10	1.3	HSS10016
H63TH-B20-75	★	63	52	20	75	50	M10	1.4	HSS10016
H63TH-B25-83	★	63	62	25	83	58	M12	1.7	HSS12016
H63TH-B32-87	★	63	62	32	87	62	M12	1.7	HSS12016
H63TH-B40-97	★	63	65	40	97	72	M16	1.8	HSS16012

Note 1) Please cut the boring bar to adjust the shank length. This also applies to indexable type drills.

* WT : Tool Weight

H

HSK-T TOOLS

HSK-T SYSTEM

BORING BAR HOLDERS Boring

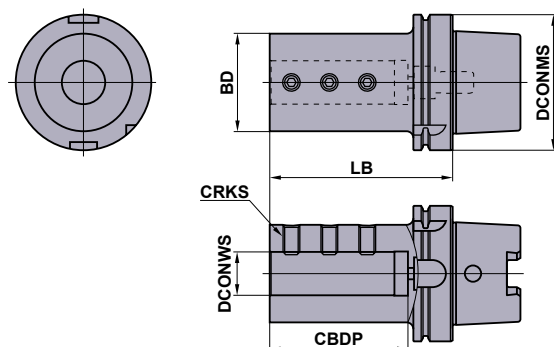



Order Number	Stock	Dimensions (mm)						* WT (kg)	 Clamp Screw
		DCONMS	BD	DCONWS	LB	CBDP	CRKS		
H100TH-B25-120	★	100	62	25	120	88	M12	3.9	HSS12016
H100TH-B32-135	★	100	72	32	135	102	M12	4.8	HSS12018
H100TH-B40-150	★	100	82	40	150	117	M16	5.9	HSS16020
H100TH-B50-180	★	100	92	50	180	147	M16	7.7	HSS16020

Note 1) Available for use with a sleeve for small round-shank tool installation.

* WT : Tool Weight

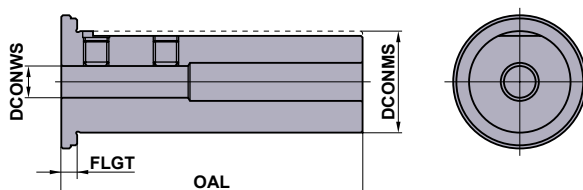
BORING BAR SLEEVES FOR H100TH-B32-135



Order Number	Stock	Dimensions (mm)				* WT (kg)	 Clamp Screw
		DCONWS	DCONMS	OAL	FLGT		
SL3208-90	★	8	32	95	5	0.6	HSS06008
SL3210-90	★	10	32	95	5	0.5	HSS08008
SL3212-90	★	12	32	95	5	0.5	HSS08008
SL3216-90	★	16	32	95	5	0.5	HSS08006
SL3220-90	★	20	32	95	5	0.4	HSS08005

Note 1) These sleeves are only compatible with H100TH-B32-135 holder.

* WT : Tool Weight

Memo

A series of horizontal dashed lines for writing.

Memo

A series of horizontal dashed lines for writing, spanning the width of the page.

SPARE PARTS

IDENTIFICATION	N002
SPARE PARTS	
CLAMP SCREW	N003
SET BOLT	N009
ADJUSTMENT SCREW / NUT	N010
SHIM	N011
SHIM PIN AND CLAMP LEVER	N014
LOCK PIN	N015
CLAMP BRIDGE	N015
BREAKER PIECE	N017
ANTI SEIZE LUBRICANT	N018



IDENTIFICATION

IDENTIFICATION OF CLAMP SCREW (Metric coarse right hand screw thread)

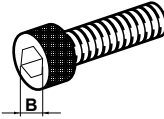

H SC 060 05

Length

Example	
Symbol	L
05	5
10	10
20	20
30	30

Screw Diameter

Example	
Symbol	d
050	M5
060	M6

Hexagonal Hole Dimensions

Diameter	Pitch	B Dimensions			
		HBH	HFC	HSC	HS \odot
M2	0.4	—	—	1.5	0.9
M2.5	0.45	—	—	2	1.3
M3	0.5	2	2	2.5	1.5
M4	0.7	2.5	2.5	3	2
M5	0.8	3	3	4	2.5
M6	1	4	4	5	3
M8	1.25	5	5	6	4
M10	1.5	6	6	8	5

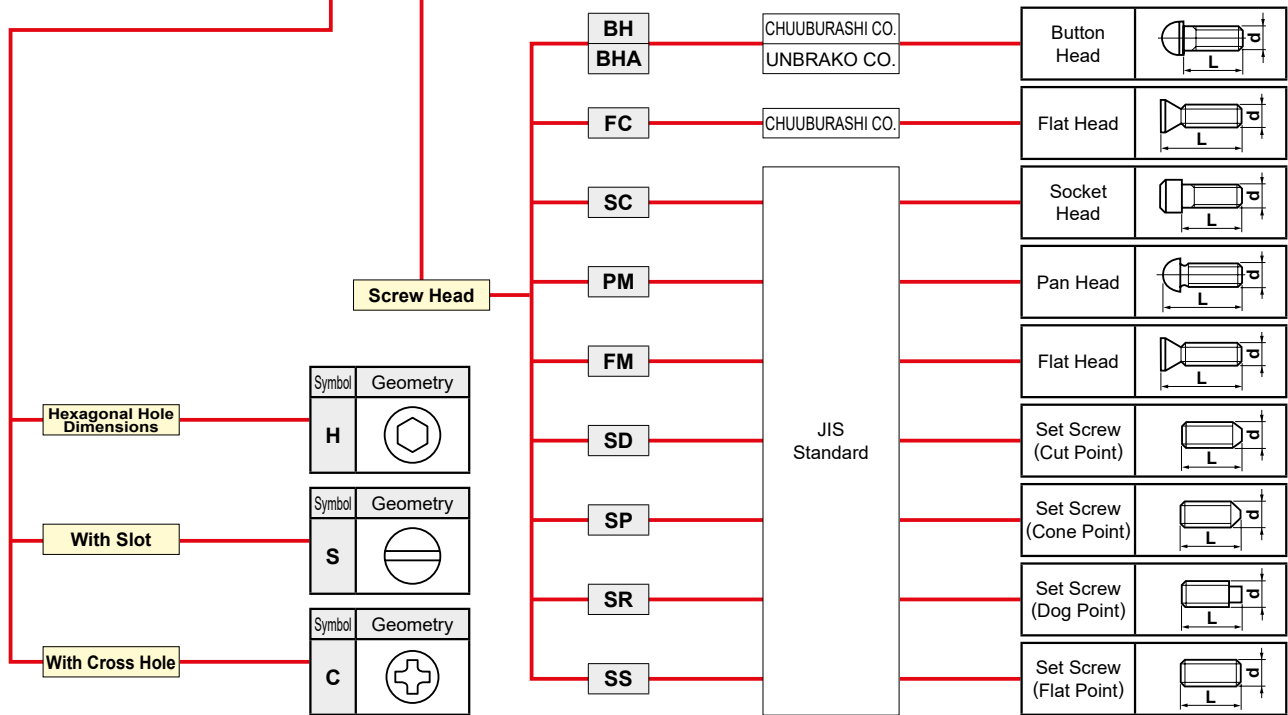

Hexagonal Hole Dimensions

Symbol	Geometry
H	

With Slot

Symbol	Geometry
S	

With Cross Hole

Symbol	Geometry
C	

SPARE PARTS Z

IDENTIFICATION OF WRENCH

HKY 15 R

Symbol	Wrench
HKY	Hexagonal Wrench
TKY	Torx Wrench
RKY	R Wrench
TIP	Torx plus Wrench

Hexagonal Wrench	
Symbol	B
15	1.5
20	2
25	2.5
30	3
35	3.5
40	4
50	5
60	6

Torx Wrench		
Symbol	B	Size
06	1.7	T6
08	2.3	T8
10	2.7	T10
15	3.3	T15
20	3.8	T20
25	4.4	T25
27	5.0	T27
30	5.5	T30

Torx plus Wrench		
Symbol	B	Size
06	1.8	6IP
07	2.1	7IP
08	2.4	8IP
10	2.8	10IP
15	3.4	15IP

R	Standard L Wrench	
L	Long L Wrench	
T	T Wrench	
F	Flag Wrench	
FS	Flag Wrench	
W	Flag Wrench	
D	Driver	
DS	Driver	
S	Wrench	

IMX 10 - WR

Symbol	Wrench
IMX	Wrench for iMX Series

Hexagonal Wrench	
Symbol	B
10	8
12	10
16	13
20	16
25	20

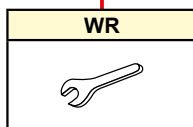

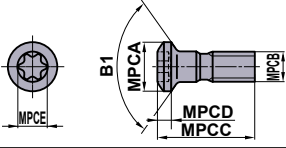
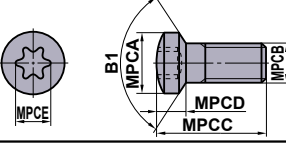
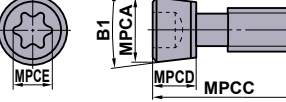
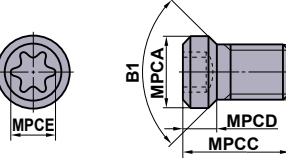
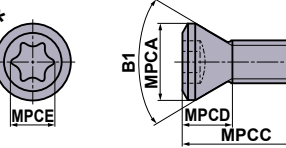
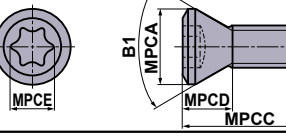
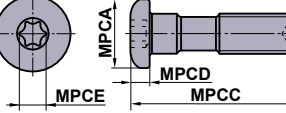

SPARE PARTS

CLAMP SCREW

Geometry	Order Number	Dimensions (mm)					Angle	MPCDS	TQ (N·m)	Tool Holder
		MPCA	MPCB	MPCC	MPCD	MPCE				
	AJS3010T10	5	M3×0.5	10	1.5	2.8	120°	T10	2.5	Profile Holder (⊕C032) AJX (⊕K180) AJX (⊕K180)
	AJS4012T15	7	M4×0.7	12	2.2	3.4	120°	T15	3.5	
	AJS5014T25	8	M5×0.8	14	2.7	4.5	120°	T25	7.5	
	BRS103	5	M3×0.5	9.9	2.9	3.4	120°	T15	3.5	
	BRS105	8	M5×0.8	13.8	3.8	4.5	120°	T25	7.5	
	CAS51T	7.9	M5×0.8	19	5	4.5	10°	T25	8.5	
	CS200T	3.2	M2×0.4	5	1.6	1.8	90°	T6	0.6	F Type Boring Bar (⊕E027)
	CS250T	3.7	M2.5×0.45	6	1.8	2.4	90°	T8	1.0	Milling Tools Series (⊕K001)
	* CS250560T	3.9	M2.5×0.45	5.2	2.5	2.4	60°	T8	1.0	BRP (⊕K190)
	CS300590T	4.1	M3×0.5	5.5	2.1	2.4	90°	T8	1.0	DCCC (⊕K200)
	CS300790TS	4.7	M3×0.5	7	2.3	2.8	90°	T10	2.0	
	CS300890T	4.1	M3×0.5	8	2.1	2.4	90°	T8	1.0	
	CS350690T	4.8	M3.5×0.6	6.5	2.4	2.8	90°	T10	2.5	MMTI Type Boring Bar (⊕G026) BRP (⊕K190)
	* CS350760T	5.5	M3.5×0.6	7	4.0	3.4	60°	T15	3.5	
	CS350790T	4.8	M3.5×0.6	7	2.4	2.8	90°	T10	3.5	
	* CS350860T	5.5	M3.5×0.6	8.4	4.0	3.4	60°	T15	3.5	DCCC (⊕K200)
	CS350990T	4.8	M3.5×0.6	9	2.4	2.8	90°	T10	2.5	AL Type Holder (⊕C034)
	CS400990T	6.0	M4×0.7	9	2.8	3.4	90°	T15	3.5	
	CS401160T	5.7	M4×0.7	11	4.5	3.4	60°	T15	3.5	
	* CS401990T	6.0	M4×0.7	19	3.0	3.9	90°	T20	3.5	AHX640S (⊕K041)
	CS451190T	6.3	M4.5×0.75	11	2.9	3.9	90°	T20	5.0	
* CS501160T	7.0	M5×0.8	11	3.6	3.9	60°	T20	5.0		
CS501290T	7.0	M5×0.8	11	3.5	4.5	90°	T25	7.5	PMR (⊕K236)	
* CS5015060T	7.2	M5×0.8	15	2.4	3.9	60°	T20	5.0		
CS502190T	8.5	M5×0.8	21	4.0	5.1	90°	T27	7.5		
CS6016060T	8.5	M6×1.0	16	4.5	4.5	60°	T25	7.5		
	CSF401260T	7.2	M4×0.5	12	5.2	3.9	60°	T20	5.0	
	DC0520T	8.5	M5×0.8	22.5	2.5	3.4	—	T15	3.5	DOUBLE CLAMP Holder (⊕C008)
	DC0621T	10.5	M6×1.0	25	4	3.9	—	T20	5.0	DOUBLE CLAMP DIMPLE BAR (⊕E015) HSK Tool Holder (⊕H001)
	DKS4	5.6	M4×0.7	18	3.5	3	—	—	3.3	
DKS5	7.6	M5×0.8	19	4.5	4	—	—	7.0		

SPARE PARTS

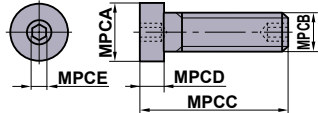
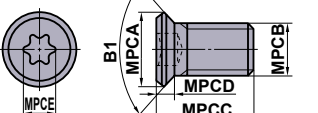
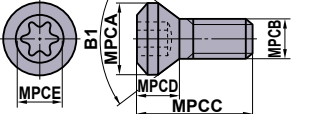
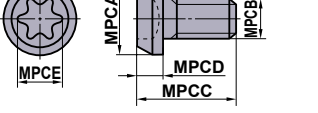
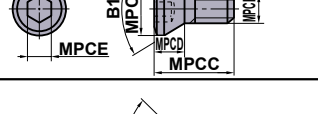
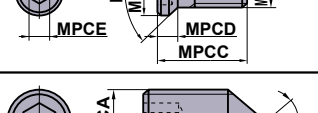
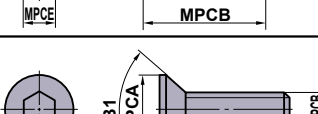
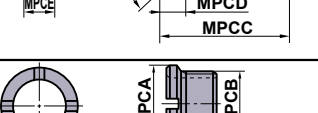
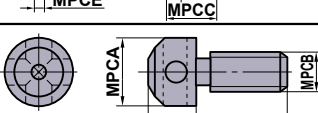
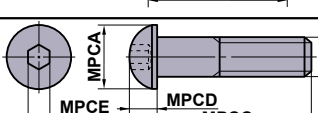
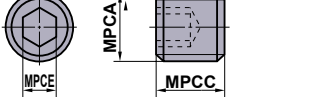
CLAMP SCREW

Geometry	Order Number	Dimensions (mm)					Angle		TQ (N·m)	Tool Holder
		MPCA	MPCB	MPCD	MPCD	MPCD	B1	MPCDS		
	EGS06019	9	M6×1	22.5	3.5	3	—	—	3.3	
	EGS08024	11	M8×1.25	28.5	4.5	4	—	—	7.0	
	FC400890T	5.6	M4×0.7	7.5	1.3	2.8	90°	T10	2.5	AL Type Holder (☉C035) AL Type Boring Bar (☉E041)
	GY05016S	8.7	M5×0.8	16	3.5	3.9	90°	T20	5.0	GY Series (☉F004)
	GY06013M	12	M6×1	18	5	5.6	—	T30	6.0	GY Series (☉F004)
	HFF06015	10	M6×1	15	6	5	80°	—	8.2	
	HS4L	5.4	M4×0.7	14	2.3	2.5	80°	—	3.8	
	HS5S	6.8	M5×0.8	9	2.8	3	80°	—	3.3	
	HS5L	6.8	M5×0.8	15	2.8	3	80°	—	6.6	
	HSP05008C	M5×0.8	8	—	—	2.5	—	—	2.5	MP Type Holder (☉C019)
	HY-A1	4.4	M3×0.5	7	2.1	2	82°	—	1.5	
	HY-V1	5.5	M3×0.5	7	2.5	2	82°	—	1.5	
	HY2	5.5	M3×0.5	10	2.5	2	82°	—	1.5	
	HY3	7	M3.5×0.6	12	2.9	2	82°	—	1.5	
	HY4	9.3	M5×0.8	16	3.6	3	82°	—	3.3	
	JSS6	6.9	M6×0.75	4.5	1.5	0.8	—	—	—	
	JSS7	8	M7×0.75	4.4	1.5	1	—	—	—	
	KS1	7	M4×0.7	14	5	—	—	—	—	
	KS2	10	M6×1	18	7	—	—	—	—	
	KS2S	10	M6×1	18	7	—	—	—	—	
	KS12	10	M6×1	26	4	4	—	—	7.0	
	LLR1	M5×0.8	—	3.5	—	2.5	—	—	—	
	LLR2	M6×1	—	5	—	3	—	—	—	

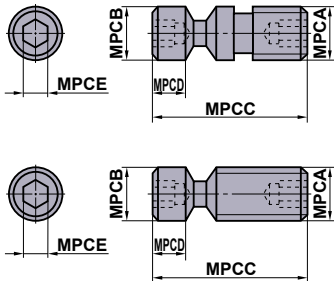
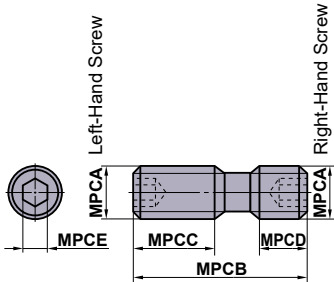
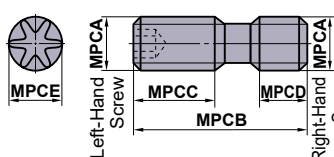
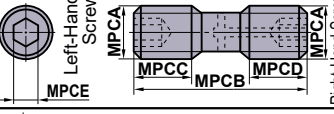
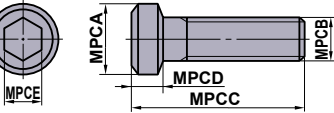
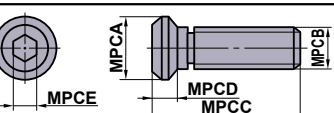
Geometry	Order Number	Dimensions (mm)					Angle B1	MPCOS	TQ (N·m)	Tool Holder		
		MPCA	MPCB	MPCC	MPCD	MPCE						
 <p>LLCS103, LLCS105 LLCS112, LLCS125 LLCS205</p> <p>The products with "*" do not have a hexagonal hole at the end marked MPCB.</p> <p>The products with "☆" do not have a hexagonal hole at the end marked MPCA.</p>	☆ LLCS103	M3×0.5	4	11	4.6	2	—	—	1.5	P Type Boring Bar (E037) HSK Tool Holder (H001)		
	* LLCS105	M5×0.8	M5×0.8	10	1.5	2	—	—	1.5			
	LLCS106	M6×1	6	16.5	3.5	2.5	—	—	2.2			
	* LLCS106S	M6×1	6	13.4	0.7	2.5	—	—	2.2			
	LLCS108	M8×1.25	8	21	6.5	3	—	—	3.3			
	* LLCS108S	M8×1.25	8	16.5	2	3	—	—	3.3			
	LLCS110	M10×1.5	10	29	8	4	—	—	7.0			
	LLCS112	M12×1	11.9	36.2	9	5	—	—	8.0			
	LLCS125	M5×0.8	M5×0.8	12	2	2	—	—	1.5			
	LLCS205	M5×0.8	M5×0.8	16	4	2	—	—	1.5			
	LLCS206	M6×1	6	26	13	2.5	—	—	2.2			
	LLCS208	M8×1.25	8	24	6.5	3	—	—	3.3			
	LLCS306	M6×1	6	21	4	2.5	—	—	2.2			
	LLCS308	M8×1.25	8	42	27.5	3	—	—	3.3			
	LLCS310	M10×1	10	29	8	4	—	—	7.0			
	LLCS410	M10×1	10	30	6.6	4	—	—	7.0			
	LLCS508	M8×1	8	24	6.5	3	—	—	3.3			
	* LLCS508S	M8×1	8	20.5	3	3	—	—	3.3			
	 <p>Left-Hand Screw Right-Hand Screw</p> <p>*Without Hexagonal Hole on Right-Hand Screw</p>	LS1	M6×1	22	8	8	3	—	—		5.0	Milling Tools Series (K001)
		LS2	M8×1	29	13	10	4	—	—		8.2	
LS3		M8×1	32	13	13	4	—	—	8.2			
* LS4		M6×1	15	8	4	3	—	—	5.0			
* LS5		M6×1	18	8	5	3	—	—	5.0			
* LS6		M8×1	24	13	5	4	—	—	8.2			
* LS7		M8×1	27	13	8	4	—	—	8.2			
* LS8		M6×0.75	18	7	7	3	—	—	5.0			
* LS9		M6×0.75	22	8	8	3	—	—	5.0			
* LS10		M7×0.75	16	6	6	4	—	—	8.2			
* LS11		M8×1	16	6	6	4	—	—	7.8			
* LS12		M8×1	24	7	7	4	—	—	7.8			
* LS13		M8×1	34	12	12	4	—	—	7.8			
* LS14		M7×0.75	24	10	10	4	—	—	7.8			
* LS16		M7×0.75	23	11	8	4	—	—	7.8			
* LS18		M7×0.75	14	6	4	4	—	—	7.8			
* LS20		M10×1.5	26	9	9	5	—	—	9.0			
* LS21		M10×1.5	32	12	12	5	—	—	9.0			
LS24		M8×1.25	24	8.5	8.5	4	—	—	7.8			
LS25		M8×1	28.5	12.0	10.5	4	—	—	8.2			
 <p>Left-Hand Screw Right-Hand Screw</p>		LS10T	M7×0.75	14	6	5	4.5	—	T25	8.0	DOUBLE CLAMP Holder (C009) AHX640W (K048)	
		LS14T	M7×0.75	24	10	10	4.5	—	T25	8.0		
		LS15T	M7×0.75	18	7	7	4.5	—	T25	8.0		
		LS19T	M6×0.75	11	4	4	3.4	—	T15	5.0		
		LS10TS	M7×0.75	13	6	4	4.5	—	T25	8.5		
	LS0622T	M6×0.75	22	8	8	3.4	—	T15	6.0			
 <p>Left-Hand Screw Right-Hand Screw</p>	LS24H	M8×1.25	24	8.5	8.5	4	—	—	8.2			
	MGS6	10	M6×1	26	4	5	—	—	9.0	APX3000 (K133)		
	MHT1	11	M8×1	18.5	3.5	4	—	—	8.7			

SPARE PARTS

CLAMP SCREW

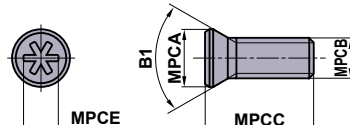
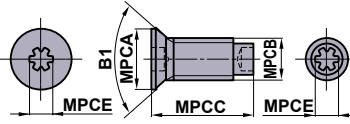
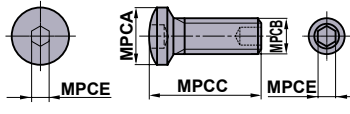
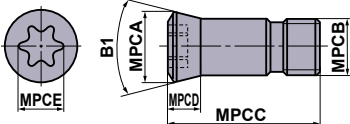
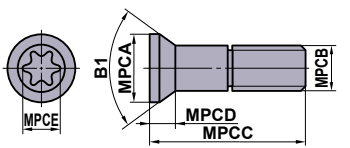
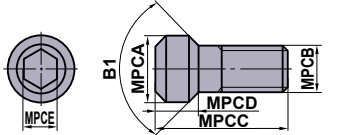
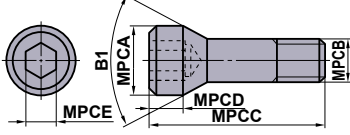
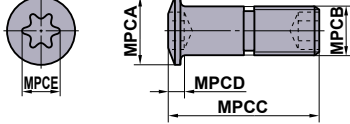
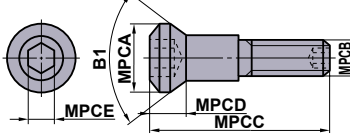
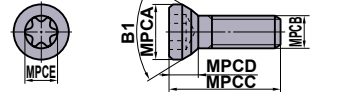
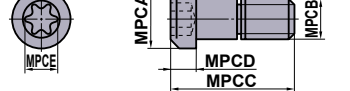
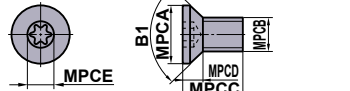
Geometry	Order Number	Dimensions (mm)					Angle	MPCDS	TQ (N·m)	Tool Holder
		MPCA	MPCB	MPCD	MPCD	MPCCE				
	NS251	3.6	M2.5×0.45	7	—	2.2	60°	—	0.7	BTVH (⊕D016) CSVH (⊕D027) CTAH-S (⊕D020)
	NS401	5.8	M4×0.7	6	—	3.6	60°	—	3.5	
	NS402W	5.85	M4×0.7	10	—	2.2	60°	—	0.7	CTAH (⊕D020) CTBH (⊕D022)
	NS403W	5.85	M4×0.7	12	—	2.2	60°	—	0.7	
	NS404W	5.8	M4×0.7	10	—	2.2	90°	—	0.7	
	NS501W	8	M5×0.8	16	—	2.5	120°	—	2.2	SMALL TOOLS (⊕D001)
	NS502W	8	M5×0.8	20	—	2.5	120°	—	2.2	
	RN-S6	9.5	M6×0.75	20.3	4.6	3.9	61°	T20	5.0	
	RN-S7	11	M7×0.75	24.7	5.2	4.5	61°	T25	7.5	
	RS3008T	4.3	M3×0.35	8.6	2	2.4	61°	T8	1.5	SRF (⊕K212) SUF (⊕K216)
	RS3510T	5	M3.5×0.35	10	2.3	2.8	61°	T10	2.5	
	RS4015T	6	M4×0.5	14	2.7	3.4	61°	T15	3.3	
	RS5020T	8.1	M5×0.5	16.4	3.6	3.9	61°	T20	5.0	
	RS6025T	9.5	M6×0.75	21.5	4.2	4.5	61°	T25	7.5	
	RS8030T	12	M8×0.75	25	5	5.6	61°	T30	10.0	
	S1	3.5	M2×0.4	5.5	2.2	1.5	92°	—	0.6	
	S3	4.5	M3×0.5	7.7	2.4	2	92°	—	1.5	
	S4	5.3	M4×0.7	8	1.8	2.5	62°	—	2.2	
	S5	6.8	M5×0.8	9	2.4	3	62°	—	3.3	
	SD32	12	M8×1.25	28	7.2	6	50°	—	9.5	
	SD40	12	M8×1.25	36	7.2	6	50°	—	9.5	
	SD50	16	M10×1.5	46	8.2	8	50°	—	1.0	
	SD63	16	M10×1.5	61	8.2	8	50°	—	1.0	
	SETS51	6.8	M5×0.8	14.8	1.5	3.4	—	T15	3.5	MMTE Type Holder (⊕G019) MMTI Type Boring Bar (⊕G026) HSK Tool Holder (⊕H001)
	SETS61	8	M6×1	20	1.8	3.9	—	T20	5.0	
	SLCS105	10	M5×0.8	25	6.3	4	90°	—	7.0	WP Type Holder (⊕C017)
	SLCS106	12	M6×1	32	6.2	4	90°	—	7.0	
	SPS1	8.5	M5×0.8	16	4	4.5	70°	T25	5.0	
	SRS5	6.7	M5×0.8	16	3.5	3.9	—	T20	5.0	
	STS1	6.8	M3×0.5	7	2.2	2.8	90°	T10	2.5	

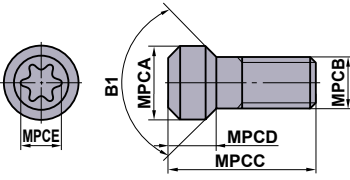
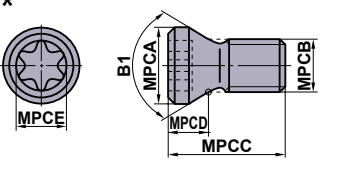
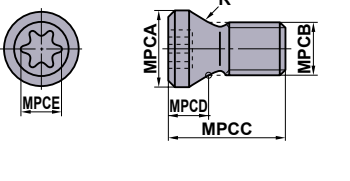
Geometry	Order Number	Dimensions (mm)					Angle	MPCDS	TQ (N·m)	Tool Holder
		MPCA	MPCB	MPCC	MPCD	MPCE				
	* TS16	2.5	M1.6×0.35	3.2	1.6	1.8	60°	T6	0.6	MICRO-DEX (☉E018)
	TS2	2.7	M2×0.4	4.6	1.4	1.8	60°	T6	0.6	
	* TS2A	2.7	M2×0.4	4.5	1.2	1.8	60°	T6	0.6	AQX (☉K172)
	TS2C	2.7	M2×0.4	3.8	1.4	1.8	60°	T6	0.6	
	☆ TS2D	3.8	M2×0.4	5.3	1.9	1.8	82°	T6	0.6	DIMPLE BAR (☉E007)
	TS21	2.7	M2×0.4	3.4	1.4	1.8	60°	T6	0.6	F Type Boring Bar (☉E029)
	* TS22	3.0	M2.2×0.45	5	1.2	1.8	60°	T6	0.6	S Type Boring Bar (☉E030)
	* TS25	3.3	M2.5×0.45	5.5	1.7	2.4	60°	T8	1.0	AQX (☉K172) AJX (☉K180)
	☆ TS25D	4.4	M2.5×0.45	6.2	2.2	2.4	82°	T8	1.0	MMTI Type Boring Bar (☉G026)
	* TS25H	3.6	M2.5×0.45	5.5	2	2.4	60°	T8	1.0	SRM2 (☉K220)
	TS202	2.7	M2×0.4	5.5	1.8	1.8	60°	T6	0.6	
	TS253	3.3	M2.5×0.45	4.5	1.7	2.4	60°	T8	1.0	Milling Tools Series (☉K001)
	TS254	3.3	M2.5×0.45	7	1.7	2.4	60°	T8	1.0	SMALL TOOLS (☉D001) PMF (☉K234)
	* TS255	3.5	M2.5×0.45	7.5	1.6	2.4	60°	T8	1.0	Profile Holder (☉C032)
		TS3	3.9	M3×0.5	6	2	2.4	60°	T8	1.0
TS304		3.9	M3×0.5	10.5	2.0	2.4	60°	T8	1.5	
TS3D		5.0	M3×0.5	6	2.3	2.8	82°	T10	2.5	DIMPLE BAR (☉E007)
* TS3SB		4.4	M3×0.5	8	2	2.4	80°	T8	1.5	AXD4000 (☉K155)
TS3SBS		4.4	M3×0.5	6.5	2	2.4	80°	T8	1.5	AXD4000 (☉K155)
☆ TS31D		4.8	M3×0.5	7.2	2.2	2.8	82°	T10	2.5	DIMPLE BAR (☉E007)
* TS32		3.9	M3×0.5	7.5	2	2.4	60°	T8	2.0	SRM2 (☉K220)
* TS33		3.9	M3×0.5	6.7	2	2.4	60°	T8	1.5	AQX (☉K172) AJX (☉K180)
TS35		4.8	M3.5×0.6	6.5	2.4	2.8	60°	T10	2.5	
* TS35D		5.3	M3.5×0.6	12	2.8	3.4	60°	T15	3.5	HSK Tool Holder (☉H001)
★ TS35R		5.7	M3.5×0.6	10	2.1	3.4	—	T15	3.5	AHX440S (☉K034) AHX475S (☉K038)
TS351		4.8	M3.5×0.6	7.2	2.4	2.8	60°	T10	2.5	AJX (☉K180) SRM2 (☉K220)
TS352		4.8	M3.5×0.6	10	3	2.8	60°	T10	2.5	VFX5 (☉K192)
TS4S		5.4	M4×0.7	7	2.4	3.4	80°	T15	3.5	
		* TS4SL	5.4	M4×0.7	8	2.4	3.4	80°	T15	4.0
	* TS4SB	5.8	M4×0.7	9	2.7	3.4	80°	T15	3.5	AXD7000 (☉K166)
	* TS4SBL	5.8	M4×0.7	10.5	2.7	3.4	80°	T15	3.5	GY SERIES (☉F004) AXD7000 (☉K166)
	TS4	5.4	M4×0.7	8	2.6	3.4	60°	T15	3.5	CE/CF/CGSP (☉K230) TSMP (☉K232)
	TS4D	5.6	M4×0.7	7.7	2.5	3.4	82°	T15	3.5	DIMPLE BAR (☉E007)
	TS42	5.4	M4×0.7	6	2.6	3.4	60°	T15	3.5	
	TS43	5.4	M4×0.7	10	2.6	3.4	60°	T15	3.5	AJX (☉K180) BRP (☉K190) SRM2 (☉K220)
	TS44	5.4	M4×0.7	12	2.6	3.4	60°	T15	3.5	
	TS406	5.4	M4×0.7	15.5	2.6	3.4	60°	T15	3.5	
	TS407	5.4	M4×0.7	9	2.6	3.4	60°	T15	3.5	AQX (☉K172) AJX (☉K180)
	TS450	5.9	M4.5×0.75	13	3.6	3.9	60°	T20	5.0	VFX6 (☉K196)
	TS5S	6.8	M5×0.8	9	2.9	4.5	80°	T25	7.5	
	* TS5SL	6.8	M5×0.8	12	2.9	4.5	80°	T25	7.5	
	TS5	6.8	M5×0.8	9	3.2	4.5	60°	T25	7.5	SP Holder (☉C024) CE/CF/CGSP (☉K230) TSMP (☉K232)
	TS5L	6.8	M5×0.8	15	2.9	4.5	80°	T25	7.5	
★ TS5R	6.9	M5×0.8	12	3.5	3.9	—	T20	5.0	WWX400 (☉K056) WJX (☉K072)	
TS52	6.8	M5×0.8	8	3.2	4.5	60°	T25	7.5	CE/CF/CGSP (☉K230)	
TS53	6.8	M5×0.8	16	3.2	4.5	60°	T25	7.5		
TS54	6.8	M5×0.8	12	3.2	4.5	60°	T25	7.5	AJX (☉K180)	
TS55	6.8	M5×0.8	10.5	3.2	4.5	60°	T25	7.5	GY SERIES (☉F004) AQX (☉K172) SPX (☉K203) SRM2 (☉K220)	
* TS6S	8.5	M6×1.0	13	4.4	5.6	60°	T30	10.0	AQX (☉K172) SRM2 (☉K220)	
* TS6	8.5	M6×1.0	16	4.4	5.6	60°	T30	10.0	SRM2 (☉K220)	

N

SPARE PARTS

SPARE PARTS

CLAMP SCREW

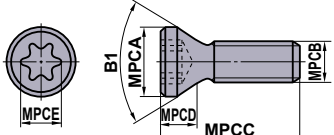
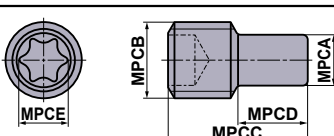
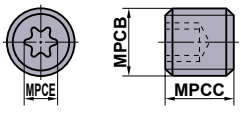
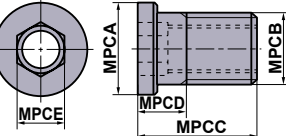
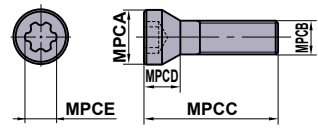
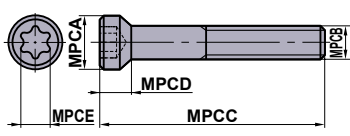
Geometry	Order Number	Dimensions (mm)					Angle B1	MPCDS	TQ (N·m)	Tool Holder
		MPCA	MPCB	MPCC	MPCD	MPC E				
	TPS20	2.7	M2×0.4	3.5	1.3	1.8	60°	6IP	0.5	
	TPS20-1	2.65	M2×0.4	4.7	2.4	1.8	60°	6IP	0.6	MVX (⊕M160)
	TPS22	3.0	M2.2×0.45	4.7	1.6	2.1	60°	7IP	0.5	
	TPS22S	3.0	M2.2×0.45	4.2	1.6	2.1	60°	7IP	0.5	
	TPS25	3.3	M2.5×0.45	5.5	1.7	2.1	60°	7IP	1.0	APX3000 (⊕K133) MVX (⊕M160)
	TPS25-1	3.3	M2.5×0.45	6.5	1.7	2.1	60°	7IP	1.0	APX3000 (⊕K133)
	TPS27F1	3.7	M2.7×0.35	6.5	1.8	2.1	60°	7IP	1.0	VPX200 (⊕K086)
	TPS27F2	3.7	M2.7×0.35	8.0	1.8	2.1	60°	7IP	1.0	VPX300 (⊕K100)
	TPS3	3.9	M3×0.5	6.7	1.4	2.82	60°	10IP	1.0	MVX (⊕M160)
	* TPS3R	4.6	M3×0.5	8.5	1.4	2.82	—	10IP	2.0	WJX09 (⊕K072)
	TPS3SB	4.4	M3×0.5	8	2.0	2.82	80°	10IP	3.0	AXD4000A (⊕K162)
	TPS35	5.3	M3.5×0.6	11.5	2.8	3.4	60°	15IP	3.5	ASX445 (⊕K026) ASX400 (⊕K068) PMR (⊕K236)
	TPS351	4.8	M3.5×0.6	7.2	1.4	2.82	60°	10IP	2.5	MVX (⊕M160)
	TPS351B	5.1	M3.5×0.6	7.2	1.4	2.82	60°	10IP	2.5	ARP (⊕K238)
	TPS4	5.3	M4×0.7	8	2.6	3.4	60°	15IP	3.5	APX4000 (⊕K140) ARP (⊕K238) MVX (⊕M160)
	TPS40F1	5.3	M4×0.5	10.5	2.8	3.4	60°	15IP	3.0	VPX300 (⊕K100)
TPS43	5.3	M4×0.7	10	2.6	3.4	60°	15IP	4.0	APX4000 (⊕K140) MVX (⊕M160)	
* TPS4R	6.4	M4×0.7	10.6	2.9	3.4	—	15IP	3.5	WSX445 (⊕K016)	
TPS54	6.8	M5×0.8	12	3.2	4.5	60°	25IP	7.5	MVX (⊕M160)	
	TSR05008S	3.5	M5×0.8	8	—	2.8	—	T10	—	
	TSR06011S	4	M6×1.0	11	—	3.9	—	T20	—	
	TSS04005	—	M4×0.7	5	—	2.4	—	T8	—	PMF (⊕K234)
	TSS04505S	—	M4.5×0.7	5	—	3.5	—	T10	3.5	FMAX (⊕K051)
	TSS05006	—	M5×0.8	6	—	2.8	—	T10	—	
	TSS06010	—	M6×1	10	—	3.9	—	T20	—	
	WCS503507H	6.3	M5×0.5	7	3.3	3.5	—	—	5.0	ASX445 (⊕K026) ASX400 (⊕K068) PMR (⊕K236)
	WCS604010H	7.8	M6×0.75	10	4.1	4.0	—	—	7.0	PMR (⊕K236)
	WS203107TPS	3.1	M2×0.25	7.3	1.7	1.8	60°	6IP	1.0	STAW (⊕M141)
	WS203108TPS	3.1	M2×0.25	8.3	1.9	1.8	60°	6IP	1.0	
	WS253909TPS	3.9	M2.5×0.35	9.5	2.4	2.4	60°	8IP	2.0	
	WS304912TPS	4.9	M3×0.35	12	3.25	2.82	60°	10IP	2.5	
	WS254012T	4	M2.5×0.45	11.5	2.2	2.4	80°	T8	2.0	TAW (⊕M150)
	WS254013T	4	M2.5×0.45	12.5	2.2	2.4	80°	T8	2.0	
	WS254014T	4	M2.5×0.45	13.5	2.2	2.4	80°	T8	2.0	
	WS254015T	4	M2.5×0.45	14.5	2.2	2.4	80°	T8	2.0	
	WS254016T	4	M2.5×0.45	15.5	2.2	2.4	80°	T8	2.0	
	WS304517T	4.5	M3×0.5	16.5	3.4	2.8	60°	T10	3.5	
	WS304518T	4.5	M3×0.5	17.5	3.4	2.8	60°	T10	3.5	
	WS355520T	5.5	M3.5×0.6	19.5	3.9	3.4	60°	T15	5.5	
	WS355521T	5.5	M3.5×0.6	20.5	3.9	3.4	60°	T15	5.5	
	WS406023T	6	M4×0.7	22.0	4.4	4.5	60°	T25	8.5	
	WS406024T	6	M4×0.7	23.0	4.4	4.5	60°	T25	8.5	
	WS508026T	8	M5×0.8	25.0	5.2	5.1	60°	T27	12.0	
WS508027T	8	M5×0.8	26.0	5.2	5.1	60°	T27	12.0		

SET BOLT

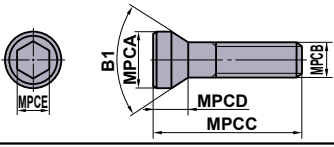
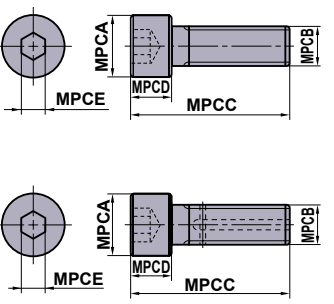
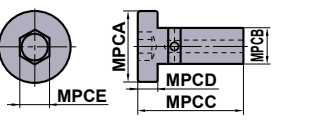
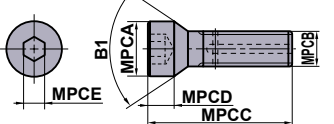
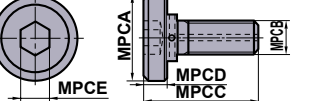
Geometry	Order Number	Dimensions (mm)					Angle	MPCDS	TQ (N·m)	Tool Holder
		MPCA	MPCB	MPCC	MPCD	MPCE				
	BOES101	15	M10×1.5	45	10	8	60°	—	10.0	
	* HSC08025H	13	M8×1.25	33	8	5	—	—	24	VPX200/300 (⊕K086,K100) ARP (⊕K238)
	HSC05030	8.5	M5×0.8	35	5	4	—	—	10	APX3000/4000 (⊕K133,K140)
	* HSC08030H	13	M8×1.25	38	8	5	—	—	24	WSX445 (⊕K016)
	HSC08045	13	M8×1.25	53	8	5	—	—	24	VPX200/300 (⊕K086,K100)
	HSC08040	13	M8×1.25	48	8	5	—	—	24	WSX445 (⊕K016)
	HSC08050	13	M8×1.25	58	8	5	—	—	24	VPX200/300 (⊕K086,K100)
	* HSC10030H	16	M10×1.5	40	10	6	—	—	40	APX3000/4000 (⊕K133,K140) AJX (⊕K180) WSX445 (⊕K016)
	HSC10035	16	M10×1.5	45	10	6	—	—	44	VFX5 (⊕K192) VFX6 (⊕K196)
	HSC10050	16	M10×1.5	60	10	8	—	—	44	APX3000/4000 (⊕K133,K140) VPX200/300 (⊕K086,K100)
	HSC10055	16	M10×1.5	65	10	8	—	—	44	VFX5 (⊕K192)
	HSC10060	16	M10×1.5	70	10	8	—	—	44	VPX200/300 (⊕K086,K100)
	HSC10070	16	M10×1.5	80	10	8	—	—	44	VPX200/300 (⊕K086,K100) ASPX (⊕K028)
	HSC12035	18	M12×1.75	47	12	10	—	—	80	WSX445 (⊕K016)
	* HSC12035H	18	M12×1.75	47	12	10	—	—	80	APX3000/4000 (⊕K133,K140) AJX (⊕K180)
	HSC12040	18	M12×1.75	52	12	10	—	—	80	
	HSC12045	18	M12×1.75	57	12	10	—	—	80	WSX445 (⊕K016)
	HSC12060	18	M12×1.75	72	12	10	—	—	80	VPX200/300 (⊕K086,K100)
	HSC12070	18	M12×1.75	82	12	10	—	—	80	APX3000/4000 (⊕K133,K140) AJX (⊕K180) WSX445 (⊕K016)
	HSC16040	24	M16×2	56	16	14	—	—	150	WSX445 (⊕K016)
	* HSC16040H	24	M16×2	56	16	14	—	—	150	APX3000/4000 (⊕K133,K140) AJX (⊕K180)
HSC16055	24	M16×2	71	16	14	—	—	150	VPX200/300 (⊕K086,K100)	
HSC16065	24	M16×2	81	16	14	—	—	150	VPX200/300 (⊕K086,K100)	
HSC16080	24	M16×2	96	16	14	—	—	150		
HSC20040	30	M20×2.5	60	20	17	—	—	320		
HSC20090	30	M20×2.5	110	20	17	—	—	320		
	HSCX12030H	24	M12×1.75	37	7	8	—	—	40	FMAX (⊕K051)
	HSCX16035H	30	M16×2	44	9	12	—	—	100	
	HSCX20035H	36	M20×2.5	46	11	14	—	—	180	
	HFF08033H	11	M8×1.25	33	5	5	90°	—	8.2	WJX09 (⊕K072)
	HFF08043H	11	M8×1.25	43	5	5	90°	—	8.2	AXD4000 (⊕K155)
	MBA16033H	40	M16×2	43	10	14	—	—	150	AHX640 (For φ100) (⊕K041) WSX445 (⊕K016)
	MBA20040H	50	M20×2.5	54	14	17	—	—	320	APX4000 (⊕K140) AHX475S (⊕K038) AHX640S (⊕K041) AXD4000 (⊕K155) AXD7000 (⊕K166) AJX (⊕K180)

* With coolant hole.

N

SPARE PARTS

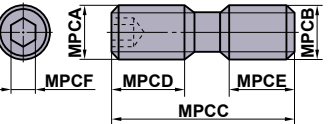
Geometry	Order Number	Dimensions (mm)						TQ (N·m)	Tool Holder
		MPCA	MPCB	MPCC	MPCD	MPCE	MPCF		
	HDS08030	M8×0.75	M8×1.25	30	13.5	11.5	4	8.2	BRP (⊕K190)
	HDS10031	M10×1.0	M10×1.5	31	14	12	5	9.0	PMF (⊕K234)

SPARE PARTS

LARGE ADJUSTMENT SCREW

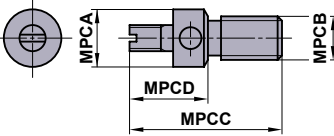
Geometry	Order Number	Dimensions (mm)					Angle	MPCDS	TQ (N·m)	Tool Holder
		MPCA	MPCB	MPCC	MPCD	MPCE	B1			
	KSS2	6.6	M5×0.8	17.5	9	—	—	—	FMAX (K051)	

MICRO ADJUSTMENT NUT

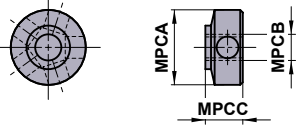
Geometry	Order Number	Dimensions (mm)					Angle	MPCDS	TQ (N·m)	Tool Holder
		MPCA	MPCB	MPCC	MPCD	MPCE	B1			
	KSN3	8.6	M3×0.35	4.3	—	—	—	—	FMAX (K051)	

SHIM

Geometry	Order Number	Dimensions (mm)						Tool Holder
		MPCA	MPCB	MPCC	MPCD	MPCE	MPCF	
	CS32	9.52	3.18	0.8	0.8	1.2	1.2	
	CS42	12.70	3.18	0.8	0.8	1.2	1.6	
	CS43	12.70	4.76	0.8	0.8	1.2	1.6	
	* PS31	8.28	2.38	0.2	0.2	0.6	0.6	
	* PS42	11.46	3.18	0.2	0.2	0.6	1.0	
	CT22	6.35	3.18	0.4	0.8	1.2	—	F Type Boring Bar (☉E028)
	CT32	9.52	3.18	0.4	0.8	1.2	—	
	* PT21	5.11	2.38	0.2	0.2	0.6	—	
	* PT32	8.28	3.18	0.2	0.2	0.6	—	
	* PT42	10.85	3.18	0.3	0.3	0.7	—	
BPT322	7.8	3.18	—	—	—	—		
	DCSVN32	9.52	3.18	0.8	1.2	—	—	DOUBLE CLAMP Holder (☉C019) DOUBLE CLAMP DIMPLE BAR (☉E017)
	ESS42	12.70	3.18	0.8	0.8	1.2	1.6	
	EST32	9.52	3.18	0.4	0.8	1.2	—	
EST43	12.70	4.76	0.4	0.8	1.2	—		
	LLSCN3T3	9.52	3.97	0.4	0.4	0.8	0.8	LL Type Holder (☉C008)
	LLSCN33	9.52	4.76	0.4	0.4	0.8	0.8	LL Type Holder (☉C008)
	LLSCN42	12.70	3.18	0.8	0.8	1.2	1.2	DOUBLE CLAMP DIMPLE BAR (☉E015)
	LLSCN53	15.87	4.76	1.2	1.2	1.6	1.6	P Type Boring Bar (☉E038)
	LLSCN63	19.05	4.76	1.2	1.2	1.6	1.6	HSK Tool Holder (☉H001)
	* LLSCP42	12.70	3.18	0.8	0.8	1.2	1.2	DOUBLE CLAMP DIMPLE BAR (☉E015)
* LLSCP63	19.05	4.76	1.2	1.2	1.6	1.6	P Type Boring Bar (☉E038) HSK Tool Holder (☉H001)	
	LLSDN32	9.52	3.18	0.8	1.2	—	—	DOUBLE CLAMP Holder (☉C010)
	LLSDN42	12.70	3.18	0.8	1.2	—	—	LL Type Holder (☉C010)
	LLSDN43	12.70	4.76	0.8	1.2	—	—	DOUBLE CLAMP DIMPLE BAR (☉E015)
	LLSDN53	15.87	4.76	1.2	1.6	—	—	P Type Boring Bar (☉E038) HSK Tool Holder (☉H001)
	* LLSDP42	12.70	3.18	0.8	1.2	—	—	DOUBLE CLAMP DIMPLE BAR (☉E015)
	LLSRN103	8.3	3.18	—	—	—	—	LL Type Holder (☉C026)
	LLSRN123	9.8	3.18	—	—	—	—	HSK Tool Holder (☉H001)
	LLSRN164	13.6	4.76	—	—	—	—	
	LLSRN204	17.3	4.76	—	—	—	—	
	LLSRN256	22.0	6.35	—	—	—	—	
	LLSRN326	28.0	6.35	—	—	—	—	
	LLSSN32	9.52	3.18	0.8	0.8	1.2	1.2	DOUBLE CLAMP DIMPLE BAR (☉E016) P Type Boring Bar (☉E037)
	LLSSN33	9.52	4.76	0.8	0.8	1.2	1.2	
	LLSSN42	12.70	3.18	0.8	0.8	1.2	1.6	
	LLSSN53	15.87	4.76	1.2	1.2	1.6	1.6	
	LLSSN63	19.05	4.76	1.2	1.2	1.6	2.0	
	LLSSN84	25.40	6.35	1.6	1.6	2.4	2.4	
* LLSSP42	12.70	3.18	0.8	0.8	1.2	1.6	DOUBLE CLAMP DIMPLE BAR (☉E016)	

N

SPARE PARTS

SPARE PARTS

SHIM

Geometry	Order Number	Dimensions (mm)						Tool Holder
		MPCA	MPCB	MPCC	MPCD	MPCE	MPCF	
	LLSTE32	7.6	3.18	0.4	0.4	0.4	—	LL Type Holder (☉C016) DOUBLE CLAMP DIMPLE BAR (☉E016) P Type Boring Bar (☉E037)
	LLSTN32	9.52	3.18	0.4	0.8	1.2	—	
	LLSTN33	9.52	4.76	0.4	0.8	1.2	—	
	LLSTN42	12.70	3.18	0.4	0.8	1.2	—	
	LLSTN53	15.87	4.76	0.8	1.2	1.6	—	
	* LLSTP32	9.52	3.18	0.4	0.8	1.2	—	
* LLSTP42	12.70	3.18	0.4	0.8	1.2	—		
	LLSWN32	9.52	3.18	0.4	0.8	1.2	—	LL Type Holder (☉C022) DOUBLE CLAMP Holder (☉C022) DOUBLE CLAMP DIMPLE BAR (☉E017)
	LLSWN3T3	9.52	3.97	0.4	0.8	1.2	—	
	LLSWN42	12.70	3.18	0.4	0.8	1.2	—	
	* LLSWP32	9.52	3.18	0.4	0.8	1.2	—	
	* LLSWP42	12.70	3.18	0.4	0.8	1.2	—	
	MHS532R/L	9.4	15.7	4.5	0.8	0.8	—	
	MHS533R/L	9.4	15.7	4.5	1.2	1.2	—	
	MHS534R/L	9.4	15.7	4.5	1.6	1.6	—	
	MHS543R/L	9.4	15.7	6.5	1.2	1.2	—	
	MLCP42	12.58	3.18	1.2	1.2	1.2	1.2	P Type Boring Bar (☉E038)
	MLDP42	12.56	3.18	1.2	1.2	—	—	P Type Boring Bar (☉E038)
	MLSP42	12.63	3.18	1.2	1.2	1.2	1.2	P Type Boring Bar (☉E037)
	MLTP32	9.50	3.18	1.2	1.2	1.2	—	P Type Boring Bar (☉E037)
	MSCN63	18.8	4.76	1.6	1.6	1.6	1.6	DOUBLE CLAMP Holder (☉C009) (For Heavy Cutting)
	MSSN63	18.8	4.76	1.6	1.6	1.6	1.6	DOUBLE CLAMP Holder (☉C012) (For Heavy Cutting)
	CT32T1	9.525	15.03	3.18	—	—	—	
	* PT32T1R	8.28	13.34	3.18	—	—	—	
	* PT32T2R	8.28	13.19	3.18	—	—	—	

Geometry	Order Number	Dimensions (mm)						Tool Holder
		MPCA	MPCB	MPCC	MPCD	MPCE	MPCF	
	PV321	9.52	3.18	0.4	0.4	—	—	MP Type Holder (☉C019)
	PV322	9.52	3.18	0.8	0.8	—	—	
	PV323	9.52	3.18	1.2	1.2	—	—	
	SPSVN32	8.06	3.18	0.3	0.3	—	—	SP Type Holder (☉C030) HSK Tool Holder (☉H001)
	STASX400N	11.00	3.00	0.4	0.4	0.4	0.4	ASX400 (☉K068)
	STASX445N	10.76	3.00	—	—	—	—	ASX445 (☉K026)
	STBS500N	12.7	3.18	0.8	0.8	0.8	0.8	
	WPSTN33	9.3	4.76	0.8	0.4	1.2	—	WP Type Holder (☉C017)
	WPSTN43	12.50	4.76	0.8	0.4	1.2	—	
	* WPSWC43	12.50	4.76	0.4	0.8	1.2	—	WP Type Holder (☉C023)
	* WPSWN43	12.50	4.76	0.4	0.8	1.2	—	

Z

SPARE PARTS

SPARE PARTS

SHIM PIN AND CLAMP LEVER

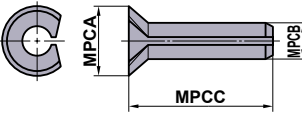
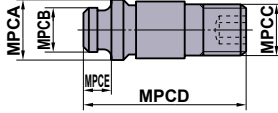
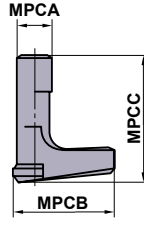
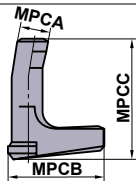
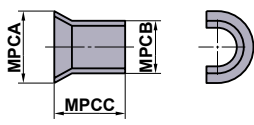
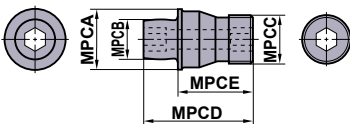
Geometry	Order Number	Dimensions (mm)					Tool Holder
		MPCA	MPCB	MPCC	MPCD	MPCE	
	BCP141	3.0	1.4	5.6	—	—	SP Type Holder (☉C030) F Type Boring Bar (☉E028) HSK Tool Holder (☉H013)
	BCP201	4.3	2	7.4	—	—	
	BCP202	4.3	2	6.4	—	—	
	BCP251	4.8	2.5	7.4	—	—	
	BCP252	4.8	2.5	6.4	—	—	
	BCP301	5.3	3	7.4	—	—	
	CCP33	6.5	3.66	M5×0.8	18.5	3	WP Holder (☉C017)
	CCP34	7.5	5.0	M6×1.0	18.5	3	
	CCP44	7.5	5.0	M5×0.8	14.2	3	
	LLCL12S	2.1	9.3	5.6	—	—	LL Type Holder (☉C016) P Type Boring Bar (☉E037) HSK Tool Holder (☉H001)
	LLCL13	3.6	10	12.5	—	—	
	LLCL13S	3.6	10	7.8	—	—	
	LLCL14	4.7	13.4	13.2	—	—	
	LLCL14S	4.7	13.6	12.2	—	—	
	LLCL15	6.0	19	17	—	—	
	LLCL16	7.5	20.8	21	—	—	
	LLCL18	8.6	25.4	25.2	—	—	
	LLCL23	3.6	12.0	11.5	—	—	
	LLCL23S	3.6	11.6	9.5	—	—	
	LLCL24	4.7	16.2	14.8	—	—	
	LLCL25	6.0	17.1	17	—	—	
		LLCL110	3.0	10.7	11.6	—	
LLCL112		3.5	13	13.5	—	—	
LLCL116		4.5	18.5	18	—	—	
LLCL120		5.6	20.3	19	—	—	
LLCL125		6	24	24	—	—	
LLCL132		8	30	27	—	—	
	LLP13	5.55	4.85	5.3	—	—	LL Type Holder (☉C008) DOUBLE CLAMP Holder (☉C008) DOUBLE CLAMP DIMPLE BAR (☉E015) P Type Boring Bar (☉E037) HSK Tool Holder (☉H001)
	LLP14	7.25	6.55	5.8	—	—	
	LLP15	8.8	8.05	8.6	—	—	
	LLP16	10.85	9.85	11.1	—	—	
	LLP18	15.35	13.05	12.0	—	—	
	LLP23	5.55	4.85	6.8	—	—	
	LLP24	7.25	6.55	9.1	—	—	
	MP6	11.9	7.8	M10×1	22.1	15	DOUBLE CLAMP Holder (☉C009) (For Heavy Cutting)

LOCK PIN

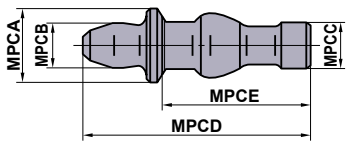
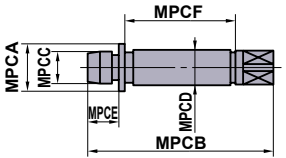
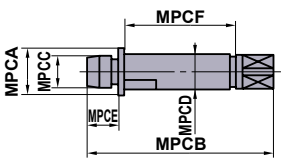
Geometry	Order Number	Dimensions (mm)						Tool Holder
		MPCA	MPCB	MPCC	MPCD	MPCE	MPCF	
	P11S	6	3.7	4	17	11.1	—	MP Type Holder (C019)
	P21S	7.5	4.9	4.5	17.2	11.5	—	
	P221US	4	18	2.11	3.5	3.3	7.7	
	P333WS	5.75	24	3.64	5.0	4.9	11.3	
	P434W	7.75	30	5.03	7.0	4.9	16.8	

CLAMP BRIDGE

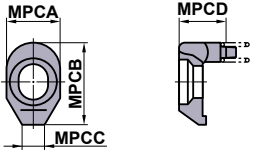
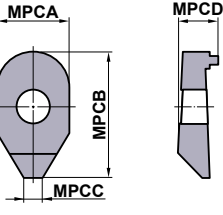
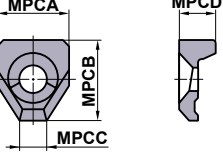
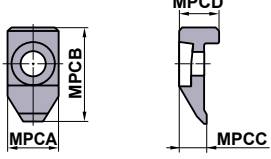
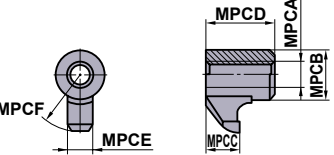
Geometry	Order Number	Dimensions (mm)						Tool Holder
		MPCA	MPCB	MPCC	MPCD	MPCE	MPCF	
	AMS3	7	12	3	3.3	—	—	Profile Holder (C032) AJX (K180)
	AMS4	9	13.5	3	3.8	—	—	
	AMS5	10	15	3.5	5	—	—	
	CA142	8	15	4	7	—	—	
	CA150	9	16	4.5	7	—	—	
	CA151	10	17	5	7	—	—	
	CA152	10	19	5	7	—	—	
	CA153	10	24	5	7	—	—	
	CA161	13	20	6	8	—	—	
	CA162	13	24	6	8	—	—	
	CA163	13	27	6	8	—	—	
	CA181	16	30	8	10	—	—	
CA183	16	37	8	10	—	—		
	CCK13	15	18.5	6	9	—	—	WP Type Holder (C017)
	CCK14	19	22	8	9.5	—	—	
	CCTC1	13	25	7	10.2	—	—	
	CK231	M6×1	8	4	7.5	4.5	9.5	
	CK232	M6×1	8	4.5	8	4.5	11.5	
	CK341	M8×1	11	5.5	13.5	6	13.5	
	CK342	M8×1	11	6	14	6	16.5	

N

SPARE PARTS

SPARE PARTS

CLAMP BRIDGE

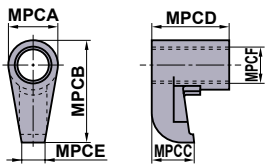
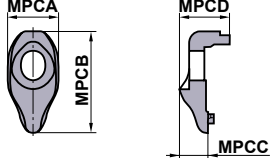
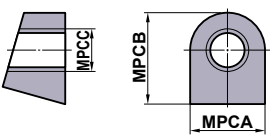
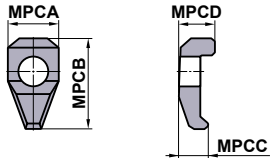
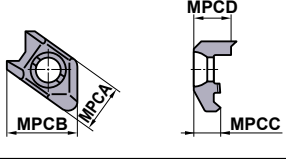
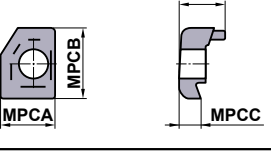
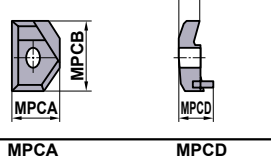
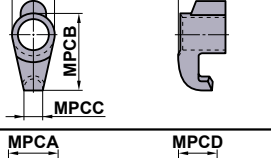
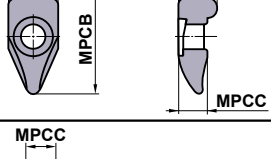
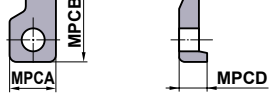
Geometry	Order Number	Dimensions (mm)						Tool Holder
		MPCA	MPCB	MPCC	MPCD	MPCE	MPCF	
	CKW6	10.9	22.5	9.2	16.8	5	M8×1	DOUBLE CLAMP Holder (☉C009) (For Heavy Cutting)
	DCK2211 DCK2613 DCK3113	11 13 13	22 26.5 31	6.57 7.35 9	11.1 12.9 14.5	— — —	— — —	DOUBLE CLAMP Holder (☉C008) DOUBLE CLAMP DIMPLE BAR (☉E015) HSK Tool Holder (☉H001)
	KGC1	12.0	15.0	M7×0.75	—	—	—	
	LK1	8	14.3	4.5	5.9	—	—	
	MHK5NR/L	15.5	23.5	8.1	12.1	—	—	
	MTK1R/L	13	17.5	5	12	—	—	MG Type Holder (☉F124) MT Type Holder (☉G024) HSK Tool Holder (☉H001)
	MTK2R/L	18	28	7	14	—	—	
	SETK51 SETK61	6.8 8.9	14.5 18.1	2.9 4.1	8 8.6	— —	— —	MMTE Type Holder (☉G019) MMTI Type Holder (☉G026) HSK Tool Holder (☉H001)
	SRK1R	9.4	21	5.5	7.5	—	—	
	UCR	12	24	8	7	—	—	

BREAKER PIECE

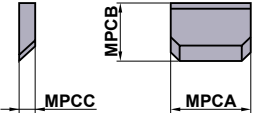
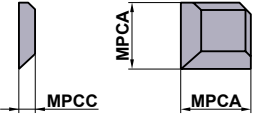
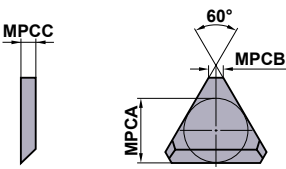
Geometry	Order Number	Dimensions (mm)					Tool Holder
		MPCA	MPCB	MPCC	IC	LBB	
	CBS3	9.4	8.0	1.5	9.525	1.5	
	CBS4	12.6	9.2	2.5	12.70	3.5	
	CBS4N	12.6	10.2	2.5	12.70	2.5	
	CBS4F	12.6	11.2	2.5	12.70	1.5	
	CBS6	18.9	14.6	2.5	19.05	4.5	
	CBS6F	18.9	17.6	2.5	19.05	1.5	
	CBS3D	8.0	—	1.5	9.525	1.5	
	CBS4D	10.2	—	2.5	12.70	2.5	
	CBT2N	5.67	1.4	1.5	6.35	1.0	F Type Boring Bar (E028) *For positive inserts, the breaker width is 0.5mm larger than the figures in the list.
	CBT3	7.20	1.4	2.5	9.525	3.5	
	CBT3N	7.87	1.4	2.5	9.525	2.5	
	CBT3F	8.53	1.4	2.5	9.525	1.5	
	CBT4N	11.07	1.4	2.5	12.70	2.5	
	CBT4F	11.73	1.4	2.5	12.70	1.5	

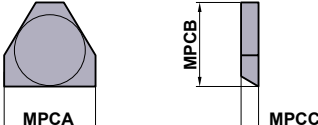

Geometry	Order Number	Dimensions (mm)			MPCD (mm)	Tool Holder
		MPCA	MPCB	MPCC		
	CBT3106	11.5	10.6	2.0	2.5—3.0	
	CBT3113	11.5	11.3	2.0	1.5—2.0	
	CBT3120	11.5	12	2.0	0.75—1.25	

Z

SPARE PARTS

ANTI SEIZE LUBRICANT

ANTI SEIZE LUBRICANT

Shape	Order Number	Stock	Volume (g)
	MK1K	★	20
	MK1KS	★	3

TECHNICAL DATA

ISO13399 COMPLIANCE	P002
TROUBLE SHOOTING FOR TURNING	P006
CHIP CONTROL FOR TURNING	P008
EFFECTS OF CUTTING CONDITIONS FOR TURNING.....	P009
FUNCTION OF THE TOOL FEATURES FOR TURNING.....	P011
FORMULAE FOR CUTTING POWER.....	P015
TROUBLE SHOOTING FOR THREADING	P016
THREADING METHODS	P017
METALLIC MATERIALS CROSS REFERENCE LIST	P020
SURFACE ROUGHNESS	P024
HARDNESS COMPARISON TABLE	P025
FIT TOLERANCE TABLE (HOLE).....	P026
FIT TOLERANCE TABLE (SHAFT).....	P028
INTERNATIONAL SYSTEM OF UNITS.....	P030
TOOL WEAR AND DAMAGE	P031
CUTTING TOOL MATERIALS	P032
GRADE CHAIN	P033
GRADES COMPARISON TABLE	P034
INSERT CHIPBREAKER COMPARISON TABLE.....	P040



ISO13399 COMPLIANCE

List of Property Symbols Complying with ISO13399

Alphabetical

Source: ISO13399 standard

URL : <https://www.iso.org/search/x/query/13399>

ISO13399 Property Symbols	Content
ADJLX	Adjustment limit maximum
ADJRG	Adjustment range
ALF	Clearance angle radial
ALP	Clearance angle axial
AN	Clearance angle major
ANN	Clearance angle minor
APMX	Depth of cut maximum
AS	Clearance angle wiper edge
ASP	Adjusting screw protrusion
AZ	Plunge depth maximum
B	Shank width
BBD	Balanced by design
BCH	Corner chamfer length
BD	Body diameter
BDX	Body diameter maximum
BHCC	Bolt hole circle count
BHTA	Body half taper angle
BMC	Body material code
BS	Wiper edge length
BSR	Wiper edge radius
CASC	Cartridge size code
CB	Chipbreaker face count
CBDP	Connection bore depth
CBMD	Chipbreaker manufacturers designation
CBP	Chipbreaker property
CCMS	Connection code machine side
CCWS	Connection code workpiece side
CCP	Chamfer corner property
CDI	Insert cutting diameter
CDX	Cutting depth maximum
CEATC	Tool cutting edge angle type code
CECC	Cutting edge condition code
CEDC	Cutting edge count
CF	Spot chamfer
CHW	Corner chamfer width
CICT	Cutting item count
CNC	Corner count
CND	Coolant entry diameter
CNSC	Coolant entry style code
CNT	Coolant entry thread size
CP	Coolant pressure
CRE	Spot radius
CRKS	Connection retention knob thread size
CSP	Coolant supply property
CTP	Coating property
CTX	Cutting point translation X-direction
CTY	Cutting point translation Y-direction
CUTDIA	Work piece parting diameter maximum
CUB	Connection unit basis
CW	Cutting width
CWX	Cutting width maximum
CXD	Coolant exit diameter

ISO13399 Property Symbols	Content
CXSC	Coolant exit style code
CZC	Connection size code
D1	Fixing hole diameter
DAH	Diameter access hole
DAXN	Axial groove outside diameter minimum
DAXX	Axial groove outside diameter maximum
DBC	Diameter bolt circle
DC	Cutting diameter
DCB	Connection bore diameter
DCBN	Connection bore diameter minimum
DCBX	Connection bore diameter maximum
DCC	Design configuration style code
DCCB	Counterbore diameter connection bore
DCIN	Cutting diameter internal
DCINN	Cutting diameter internal minimum
DCINX	Cutting diameter internal maximum
DCN	Cutting diameter minimum
DCON	Connection diameter
DCONMS	Connection diameter machine side
DCONWS	Connection diameter workpiece side
DCSC	Cutting diameter size code
DCSFMS	Contact surface diameter machine side
DCX	Cutting diameter maximum
DF	Flange diameter
DHUB	Hub diameter
DMIN	Minimum bore diameter
DMM	Shank diameter
DN	Neck diameter
DRVA	Drive angle
EPSR	Insert included angle
FHA	Flute helix angle
FHCSA	Fixing hole countersunk angle
FHCSD	Fixing hole countersunk diameter
FLGT	Flange thickness
FMT	Form type
FXHLP	Fixing hole property
GAMF	Rake angle radial
GAMN	Rake angle normal
GAMO	Rake angle orthogonal
GAMP	Rake angle axial
GAN	Insert rake angle
H	Shank height
HA	Thread height theoretical
HAND	Hand
HBH	Head bottom offset height
HBKL	Head back offset length
HBKW	Head back offset width
HBL	Head bottom offset length
HC	Thread height actual
HF	Functional height
HHUB	Hub height
HTB	Body height
IC	Inscribed circle diameter
IFS	Insert mounting style code
IIC	Insert interface code
INSL	Insert length
KAPR	Tool cutting edge angle
KCH	Corner chamfer angle

TECHNICAL DATA

ISO13399 Property Symbols	Content
KRINS	Cutting edge angle major
KWW	Keyway width
KYP	Keyway property
L	Cutting edge length
LAMS	Inclination angle
LB	Body length
LBB	Chipbreaker width
LBX	Body length maximum
LCCB	Counterbore depth connection bore
LCF	Length chip flute
LDRED	Reduced body diameter length
LE	Cutting edge effective length
LF	Functional length
LFA	a dimension on lf
LH	Head length
LPR	Protruding length
LS	Shank length
LSC	Clamping length
LSCN	Clamping length minimum
LSCX	Clamping length maximum
LTA	LTA length (length from MCS to CRP)
LU	Usable length
LUX	Usable length maximum
M	m-dimension
M2	Distance between the nominal inscribed circle and the corner of an insert that has the secondary included angle
MHA	Mounting hole angle
MHD	Mounting hole distance
MHH	Mounting hole height
MIID	Master insert identification
MTP	Clamping type code
NCE	Cutting end count
NOF	Flute count
NOI	Insert index count
NT	Tooth count
OAH	Overall height
OAL	Overall length
OAW	Overall width
PDPT	Profile depth insert
PDX	Profile distance ex
PDY	Profile distance ey
PFS	Profile style code
PL	Point length
PNA	Profile included angle
PRFRAD	Profile radius
PSIR	Tool lead angle
PSIRL	Cutting edge angle major left hand
PSIRR	Cutting edge angle major right hand
RAL	Relief angle left hand
RAR	Relief angle right hand
RCP	Rounded corner property
RE	Corner radius
REL	Corner radius left hand
RER	Corner radius right hand
RMPX	Ramping angle maximum
RPMX	Rotational speed maximum
S	Insert thickness
S1	Insert thickness total
SC	Insert shape code
SDL	Step diameter length
SIG	Point angle

ISO13399 Property Symbols	Content
SSC	Insert seat size code
SX	Shank cross section shape code
TC	Tolerance class insert
TCE	Tipped cutting edge code
TCTR	Thread tolerance class
TD	Thread diameter
THFT	Thread form type
THL	Threading length
THLGTH	Thread length
THSC	Tool holder shape code
THUB	Hub thickness
TP	Thread pitch
TPI	Threads per inch
TPIN	Threads per inch minimum
TPIX	Threads per inch maximum
TPN	Thread pitch minimum
TPT	Thread profile type
TPX	Thread pitch maximum
TQ	Torque
TSYC	Tool style code
TTP	Thread type
ULDR	Usable length diameter ratio
UST	Unit system
W1	Insert width
WEP	Wiper edge property
WF	Functional width
WF2	Distance between the cutting reference point and the front seating surface of a turning tool
WFS	Functional width secondary
WT	Weight of item
ZEFF	Face effective cutting edge count
ZEFP	Peripheral effective cutting edge count
ZNC	Cutting edge center count
ZNF	Face mounted insert count
ZNP	Peripheral mounted insert count

List of Reference Symbols Complying with ISO13399

ISO13399 Reference Symbols	Content
CIP	Coordinate system In Process
CRP	Cutting Reference Point
CSW	Coordinate System Workpiece side
MCS	Mounting Coordinate System
PCS	Primary Coordinate System

TROUBLE SHOOTING FOR TURNING

Trouble		Solution	Insert Grade Selection				Cutting Conditions				Style and Design of the Tool					Machine, Installation of Tool						
			Select a harder grade	Select a tougher grade	Select a grade with better thermal shock resistance	Select a grade with better adhesion resistance	Cutting speed	Feed	Depth of cut	Coolant		Select chipbreaker	Rake	Corner radius	Lead angle	Honing strengthens the cutting edge	Class of insert	Improve tool holder rigidity	Increase clamping rigidity of the tool and workpiece	Decrease holder overhang	Decrease power and machine backlash	
										Do not use water-soluble cutting fluid	Determine dry or wet cutting											Up ↗
Deterioration of Tool Life	Insert wear quickly generated	Improper tool grade	●																			
		Improper cutting edge geometry									●	↗	↗	↗	●	↘						
		Improper cutting speed					↘	↗			●											
	Chipping or fracturing of cutting edge	Improper tool grade		●																		
		Improper cutting conditions						↘	↘													
		Lack of cutting edge strength.									●		↗		↗							
		Thermal crack occurs			●		↘	↘	↘	●	●											
Deterioration of Surface Finish	Poor finished surface	Build-up edge occurs			●	↗	↗		●	●												
		Lack of rigidity														●	●	●	●			
Out of Tolerance	Dimensions are not constant	Poor insert accuracy													●							
		Large cutting resistance and cutting edge flank									●	●	↘	↘	↘	●	●	●	●			
Out of Tolerance	Necessary to adjust often because of over-size	Improper tool grade	●																			
		Improper cutting conditions					↘	↗														
Deterioration of Surface Finish	Poor finished surface	Welding occurs				↗			●	●												
		Improper cutting edge geometry									●		↗									
		Chattering					↘	↘	↘							●	●	●	●			
Generation of Heat	Workpiece over heating can cause poor accuracy and short life of insert	Improper cutting conditions				↘	↘	↘														
		Improper cutting edge geometry									●	↗			↘							

Trouble		Solution	Insert Grade Selection				Cutting Conditions				Style and Design of the Tool				Machine, Installation of Tool							
			Select a harder grade	Select a tougher grade	Select a grade with better thermal shock resistance	Select a grade with better adhesion resistance	Cutting speed	Feed	Depth of cut	Coolant	Chipbreaker	Rake	Corner radius	Lead angle	Honing strengthens the cutting edge	Class of insert	Improve tool holder rigidity	Increase clamping rigidity of the tool and workpiece	Decrease holder overhang	Decrease power and machine backlash		
Factors						Up ↗	Down ↘		Do not use water-soluble cutting fluid	Determine dry or wet cutting	Up ↗	Down ↘										
Burrs, Chipping etc.	Burrs (Steel, Aluminium)	Notch wear	●																			
		Improper cutting conditions					↘ ●	↗ ●			Wet ●											
		Improper cutting edge geometry										●	↗ ●	↘ ●	↘ ●	↘ ●						
	Workpiece chipping (Cast iron)	Improper cutting conditions					↘ ●	↘ ●														
		Improper cutting edge geometry										●	↗ ●	↗ ●	↗ ●	↘ ●						
		Vibration occurs															●	●	●	●		
	Burrs (Mild steel)	Improper tool grade			●																	
		Improper cutting conditions					↗ ●			●	Wet ●											
		Improper cutting edge geometry										●	↗ ●			↘ ●						
		Vibration occurs															●	●	●	●		
	Poor Chip Dispersal	Long chips	Improper cutting conditions				↘ ●	↗ ●	↗ ●		Wet ●											
			Large chip control range										●									
Improper cutting edge geometry														↘ ●	↘ ●							
Chips are short and scattered		Improper cutting conditions					↘ ●	↘ ●			Dry ●											
		Small chip control range										●										
		Improper cutting edge geometry												↗ ●	↗ ●							



TECHNICAL DATA

CHIP CONTROL FOR TURNING

CHIP BREAKING CONDITIONS IN STEEL TURNING

Type	A Type	B Type	C Type	D Type	E Type
Small Depth of Cut $d < 7\text{mm}$					
Large Depth of Cut $d = 7 - 15\text{mm}$					
Curl Length l	No curl	$l \geq 50\text{mm}$	$l \leq 50\text{mm}$ 1-5 Curl	$\cong 1$ Curl	Less Than 1 Curl Half a Curl
Note	<ul style="list-style-type: none"> ● Irregular continuous shape ● Tangle around tool and workpiece 	<ul style="list-style-type: none"> ● Regular continuous shape ● Long chips 	Good	Good	<ul style="list-style-type: none"> ● Chip scattering ● Chattering ● Poor finished surface ● Maximum

● Cutting speed and chip control range of chipbreaker

In general, when cutting speed increases, the chip control range tends to become narrower.

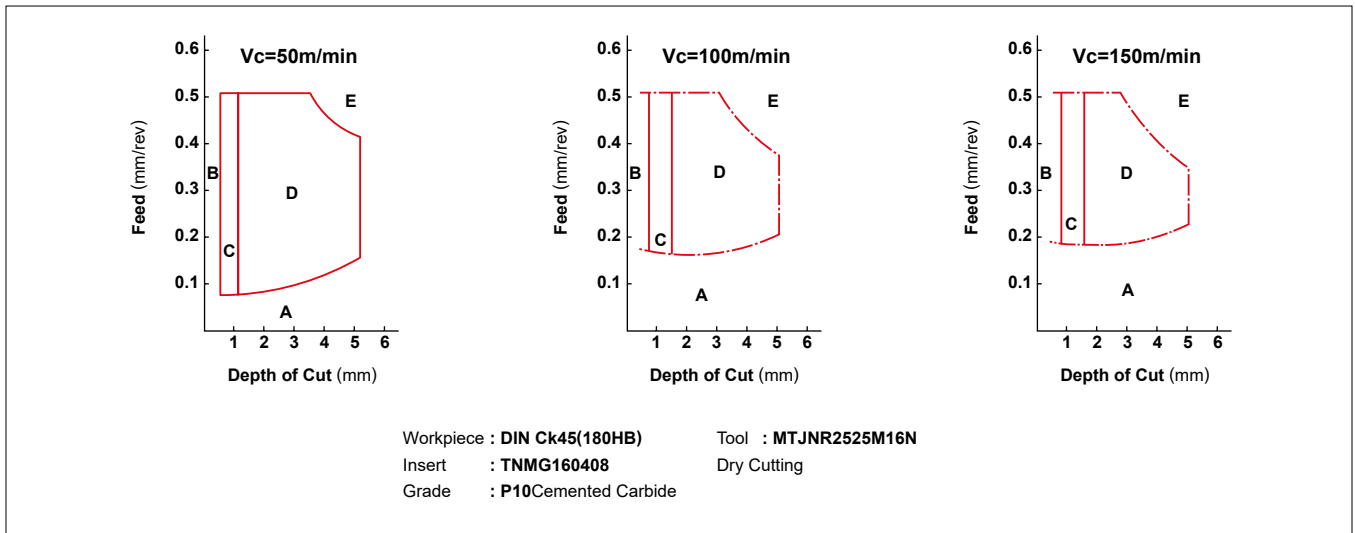

● Effects of coolant on the chip control range of a chipbreaker

If the cutting speed is the same, the range of chip control differs according to whether coolant is used or not.

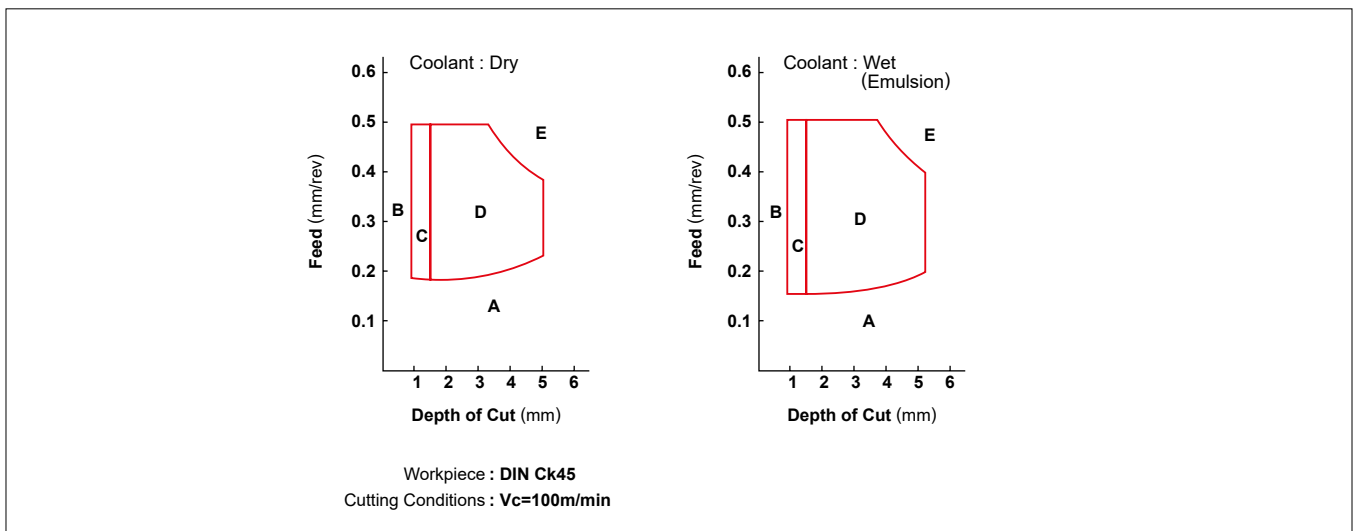

EFFECTS OF CUTTING CONDITIONS FOR TURNING

■ EFFECTS OF CUTTING CONDITIONS

Ideal conditions for cutting are short cutting time, long tool life and high cutting accuracy. In order to obtain these conditions, a selection of efficient cutting conditions and tools, based on work material, hardness, shape and machine capability is necessary.

■ CUTTING SPEED

Cutting speed has severe impact on tool life. Increasing cutting speed increases cutting temperature and results in a shortened tool life. Cutting speed varies depending on the type and hardness of the work material. Selecting a tool grade suitable for the cutting speed is necessary.

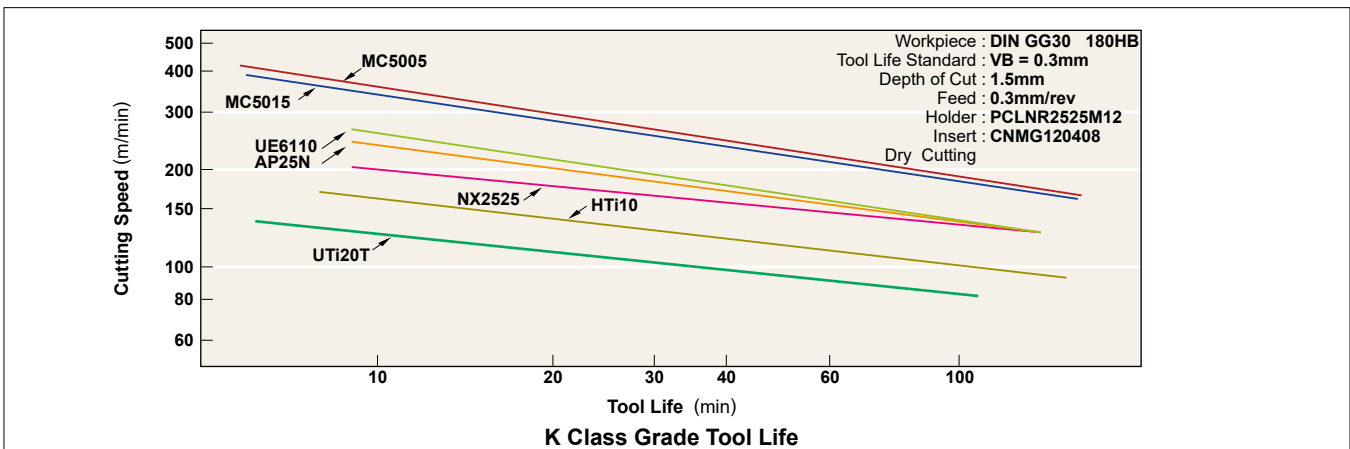
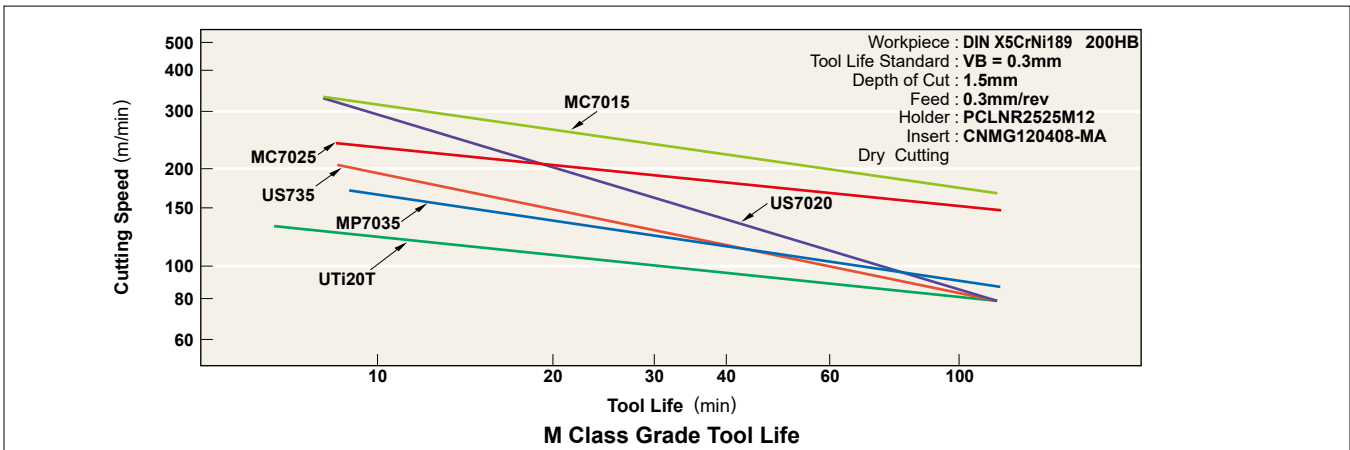
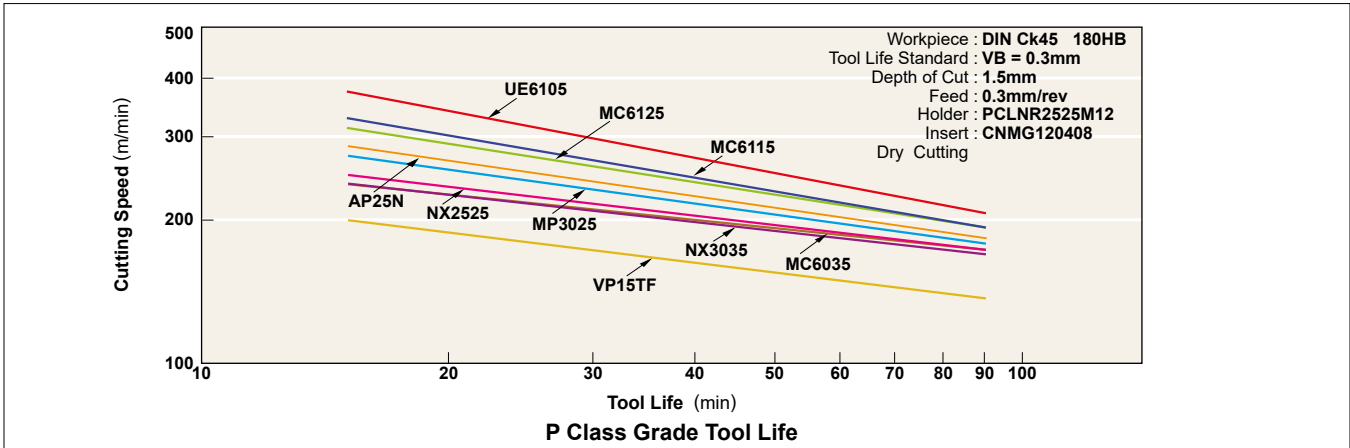

● Effects of Cutting Speed

1. Increasing cutting speed by 20% decreases tool life by 50%. Increasing cutting speed by 50% decreases tool life by 80%.
2. Cutting at low cutting speed (20–40m/min) tends to cause chattering. Thus, tool life is shortened.

EFFECTS OF CUTTING CONDITIONS FOR TURNING

■ FEED

When cutting with a general holder, feed is the distance a holder moves per workpiece revolution. In milling, feed is the distance a machine table moves per cutter revolution divided by the number of inserts. Thus, it is indicated as feed per tooth. Feed rate relates to finished surface roughness.

● Effects of Feed

1. Decreasing feed rate results in flank wear and shortens tool life.
2. Increasing feed rate increases cutting temperature and flank wear. However, effects on the tool life is minimal compared to cutting speed.
3. Increasing feed rate improves machining efficiency.

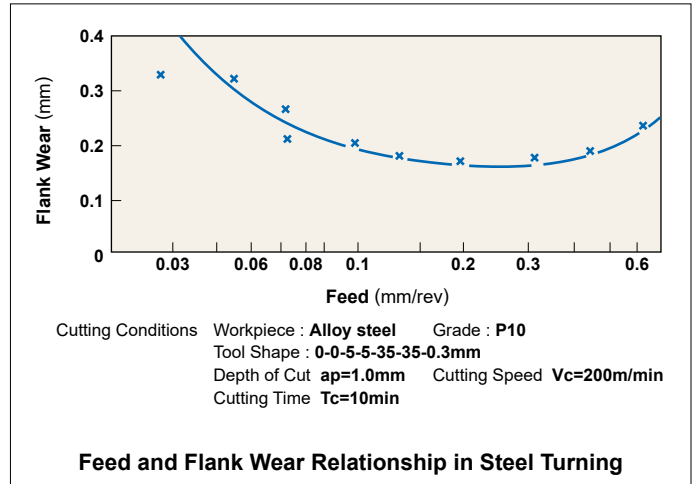

■ DEPTH OF CUT

Depth of cut is determined according to the required stock removal, shape of workpiece, power and rigidity of the machine and tool rigidity.

● Effects of Depth of Cut

1. Changing depth of cut doesn't effect tool life greatly.
2. Small depths of cut result in friction when cutting the hardened layer of a workpiece. Thus tool life is shortened.
3. When cutting uncut surfaces or cast iron surfaces, the depth of cut needs to be increased as much as the machine power allows in order to avoid cutting the impure hard surface layer with the tip of cutting edge and therefore prevent chipping and abnormal wear.

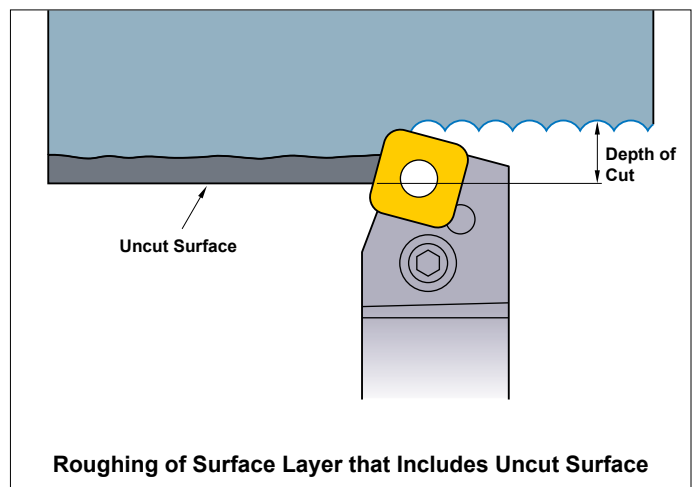
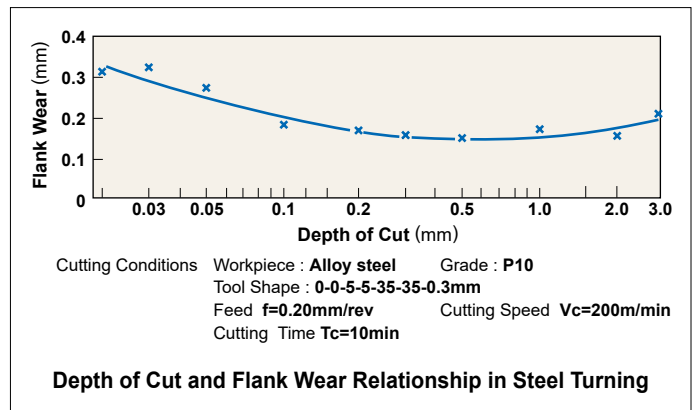

P

TECHNICAL DATA

FUNCTION OF TOOL FEATURES FOR TURNING

RAKE ANGLE

Rake angle is the cutting edge angle that has a large effect on cutting resistance, chip disposal, cutting temperature and tool life.

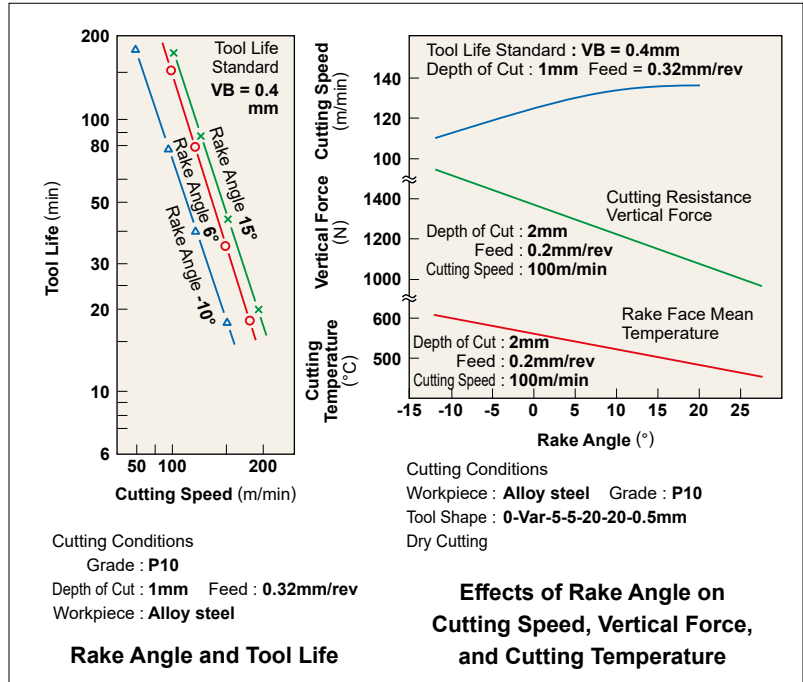
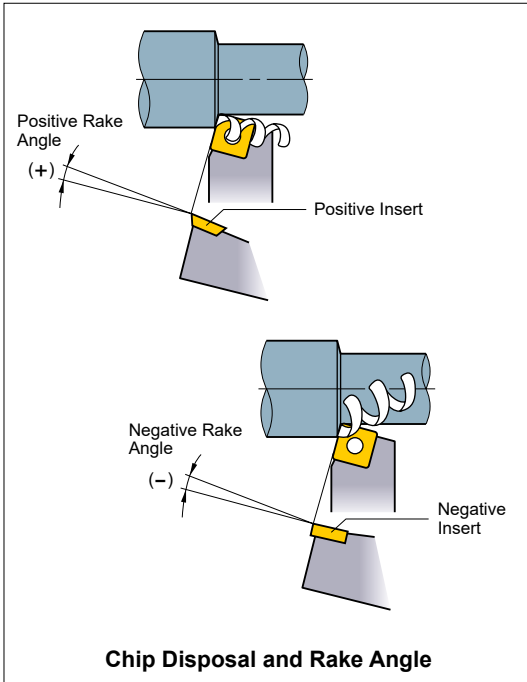

Effects of Rake Angle

1. Increasing rake angle in the positive (+) direction improves sharpness.
2. Increasing rake angle by 1° in the positive (+) direction decreases cutting power by about 1%.
3. Increasing rake angle in the positive (+) direction lowers cutting edge strength and in the negative (-) direction increases cutting resistance.

When to Increase Rake Angle in the Negative (-) Direction

- Hard workpiece.
- When cutting edge strength is required such as in interrupted cutting and uncut surface cutting.

When to Increase Rake Angle in the Positive (+) Direction

- Soft workpiece.
- Workpiece is easily machined.
- When the workpiece or the machine have poor rigidity.

FLANK ANGLE

Flank angle prevents friction between the flank face and workpiece resulting in a smooth feed.

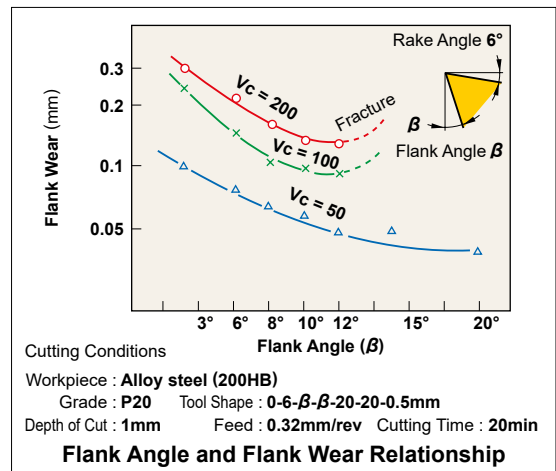
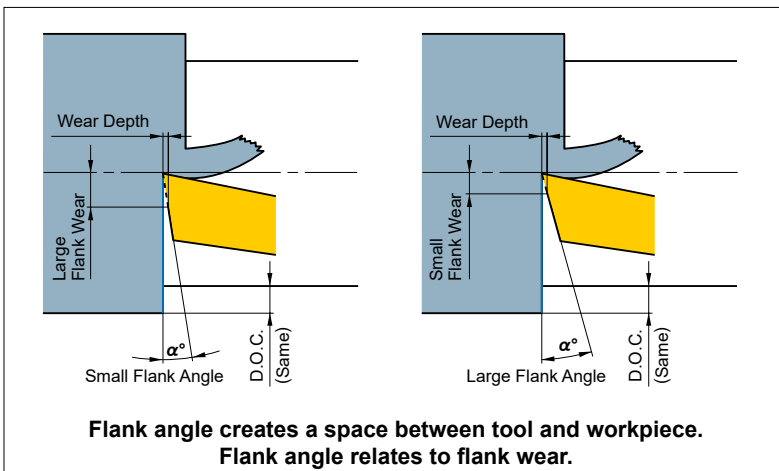

Effects of Flank Angle

1. Increasing flank angle decreases flank wear occurrence.
2. Increasing flank angle lowers cutting edge strength.

When to Decrease Flank Angle

- Hard workpieces.
- When cutting edge strength is required.

When to Increase Flank Angle

- Soft workpieces.
- Workpieces suffer easily from work hardening.

FUNCTION OF TOOL FEATURES FOR TURNING

■ SIDE CUTTING EDGE ANGLE (LEAD ANGLE)

Side cutting edge angle and corner angle lower impact load and effect feed force, back force and chip thickness.

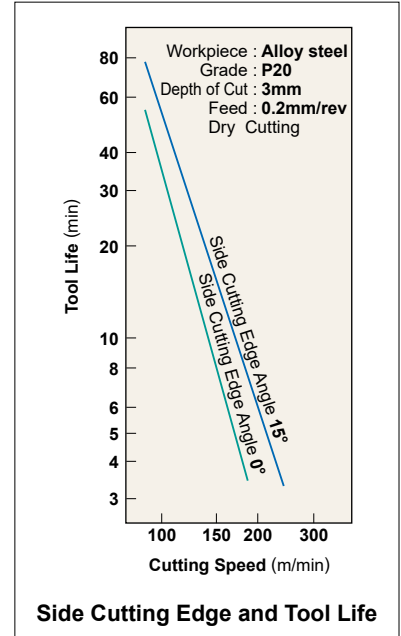
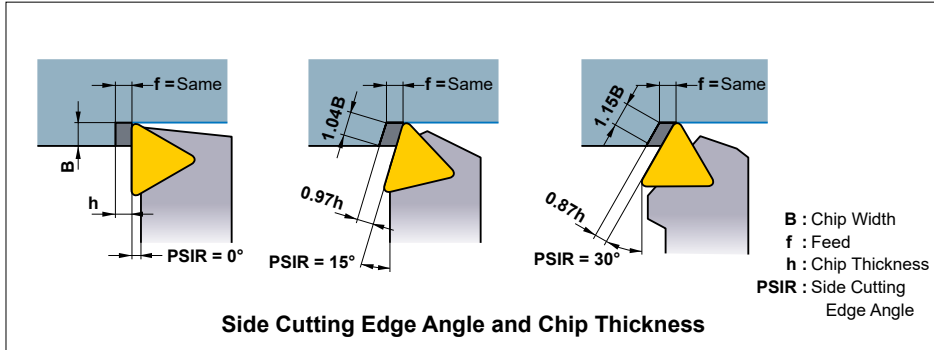

● Effects of Side Cutting Edge Angle (Lead Angle)

1. At the same feed rate, increasing the side cutting edge angle increases the chip contact length and decreases chip thickness. As a result, the cutting force is dispersed on a longer cutting edge and tool life is prolonged. (Refer to the chart.)
2. Increasing the side cutting edge angle increases force a' . Thus, thin, long workpieces can suffer from bending.
3. Increasing the side cutting edge angle decreases chip control.
4. Increasing the side cutting edge angle decreases the chip thickness and increases chip width. Thus, breaking the chips is difficult.

When to Decrease Lead Angle

- Finishing with a small depth of cut.
- Thin, long workpieces.
- When the machine has poor rigidity.

When to Increase Lead Angle

- Hard workpieces which produce high cutting temperature.
- When roughing a large diameter workpiece.
- When the machine has high rigidity.

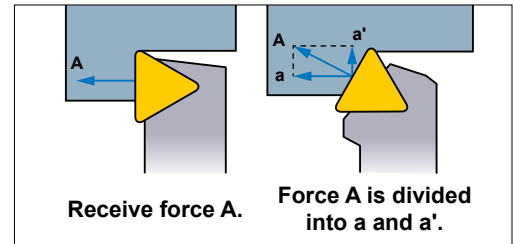

■ END CUTTING EDGE ANGLE

The end cutting edge angle avoids interference between the machined surface and the tool (end cutting edge). Usually $5^\circ - 15^\circ$.

● Effects of End Cutting Edge Angle

1. Decreasing the end cutting edge angle increases cutting edge strength, but it also increases cutting edge temperature.
2. Decreasing the end cutting edge angle increases the back force and can result in chattering and vibration while machining.
3. Small end cutting edge angle for roughing and a large angle when finishing are recommended.

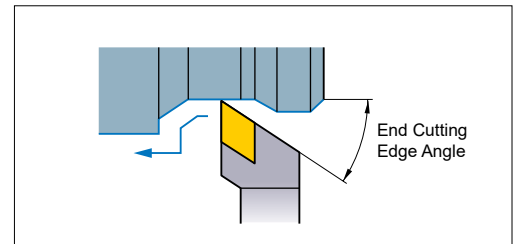

■ CUTTING EDGE INCLINATION

Cutting edge inclination indicates inclination of the rake face. When heavy cutting, the cutting edge receives an extremely large shock at the beginning of cutting. Cutting edge inclination keeps the cutting edge from receiving this shock and prevents fracturing. $3^\circ - 5^\circ$ in turning and $10^\circ - 15^\circ$ in milling are recommended.

● Effects of Cutting Edge Inclination

1. Negative (-) cutting edge inclination disposes chips in the workpiece direction, and positive (+) disposes chips in the opposite direction.
2. Negative (-) cutting edge inclination increases cutting edge strength, but it also increases back force of cutting resistance. Thus, chattering easily occurs.

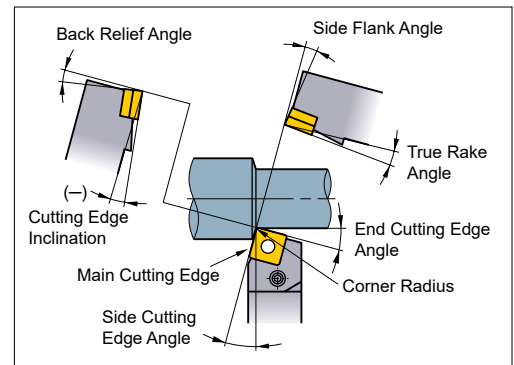

■ HONING AND LAND

Honing and land are cutting edge shapes that maintain cutting edge strength. Honing can be round or chamfer type. The optimal honing width is approximately 1/2 of the feed. Land is the narrow flat area on the rake or flank face.

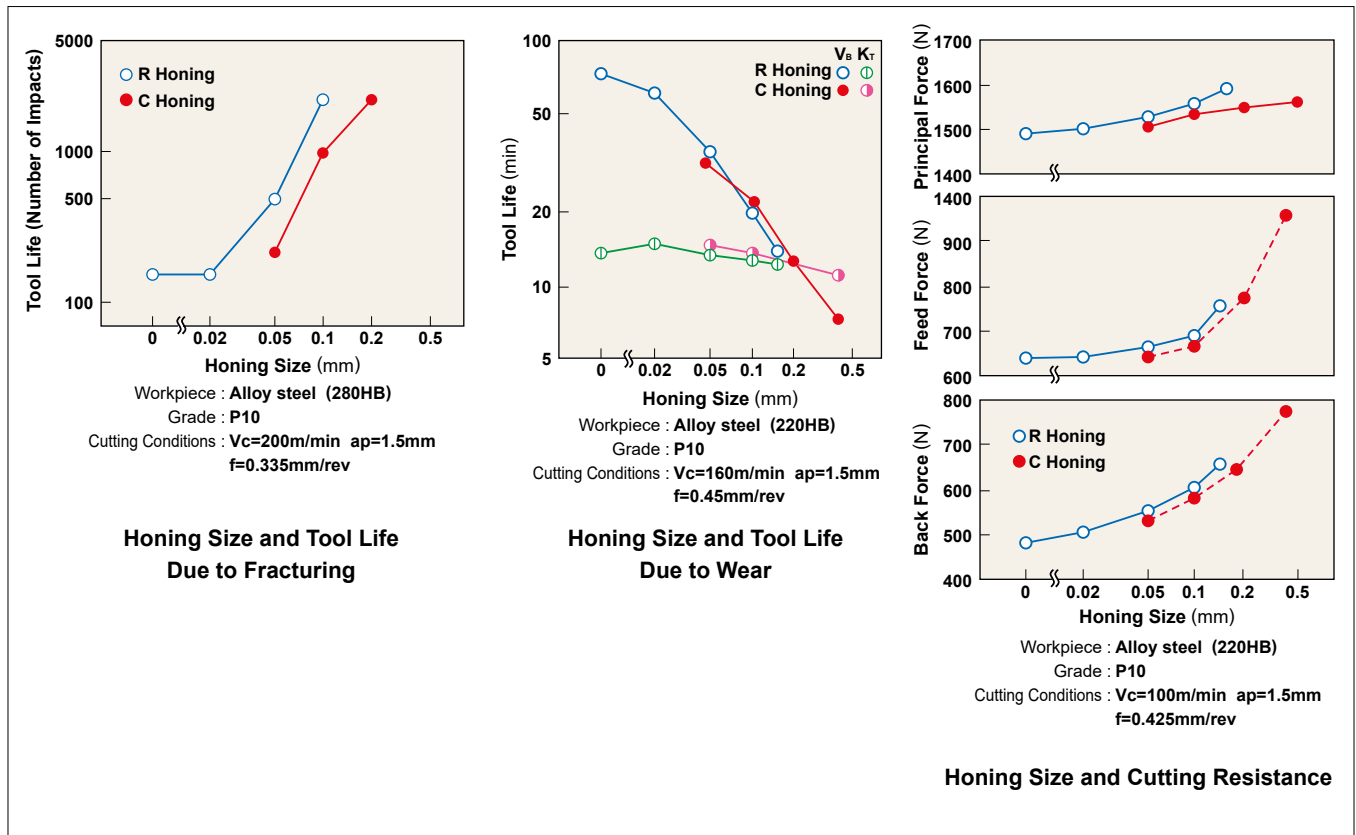
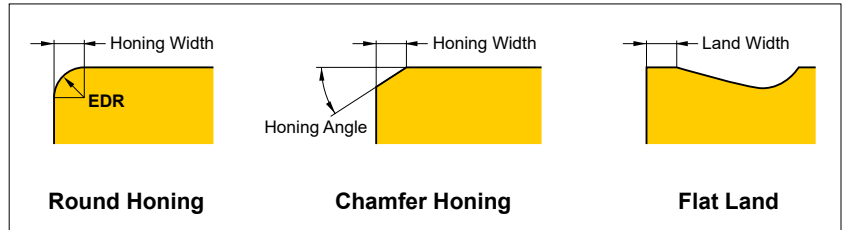

● Effects of Honing

1. Enlarging the honing increases cutting edge strength, tool life and reduces fracturing.
2. Enlarging the honing increases flank wear occurrence and shortens tool life. Honing size doesn't affect rake wear.
3. Enlarging the honing increases cutting resistance and chattering.

When to Decrease Honing Size

- When finishing with a small depth of cut and small feed.
- Soft workpieces.
- When the workpiece and the machine have poor rigidity.

When to Increase Honing Size

- Hard workpieces.
- When cutting edge strength is required for uncut surfaces and interrupted cutting.
- When the machine has high rigidity.

Note 1) Cemented carbide, UTi, coated diamond and indexable cermet inserts have round honing as standard already.

FUNCTION OF TOOL FEATURES FOR TURNING

■ RADIUS

Radius effects the cutting edge strength and finished surface. In general, a corner radius 2–3 times the feed is recommended.

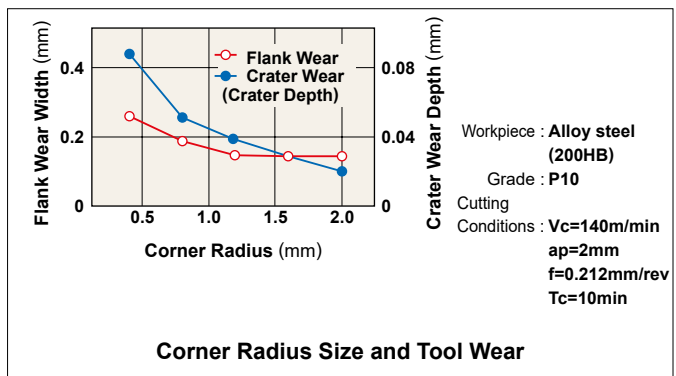
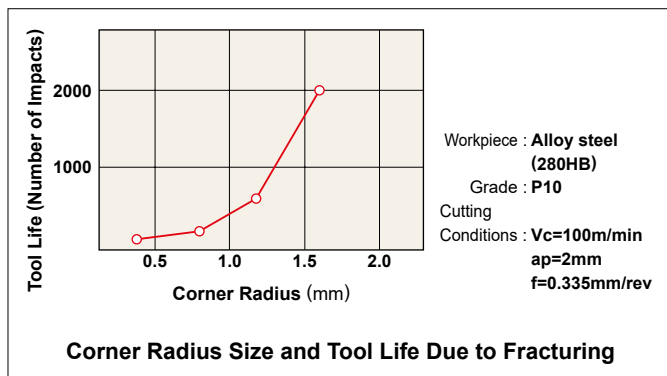
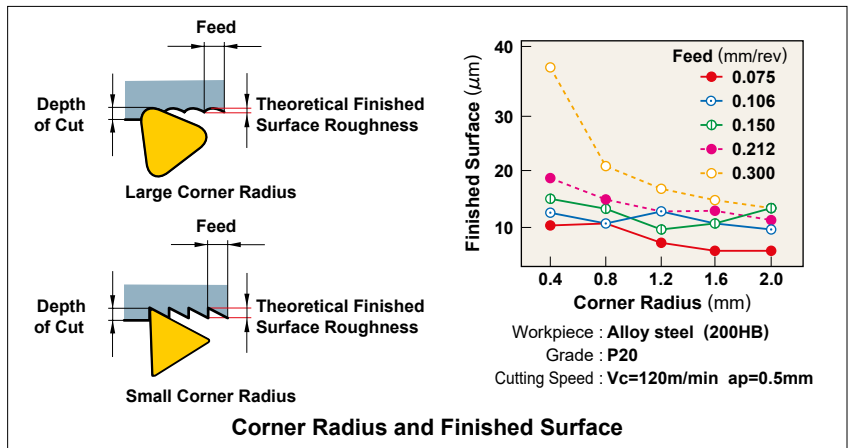

● Effects of Corner Radius

1. Increasing the corner radius improves the surface finish.
2. Increasing the corner radius improves cutting edge strength.
3. Increasing the corner radius too much increases the cutting resistance and causes chattering.
4. Increasing the corner radius decreases flank and rake wear.
5. Increasing the corner radius too much results in poor chip control.

When to Decrease Corner Radius

- Finishing with small depth of cut.
- Thin, long workpieces.
- When the machine has poor rigidity.

When to Increase Corner Radius

- When cutting edge strength is required for interrupted cutting and uncut surface cutting.
- When roughing a workpiece with a large diameter.
- When the machine has high rigidity.

● Corner Radius and Chip Control Range

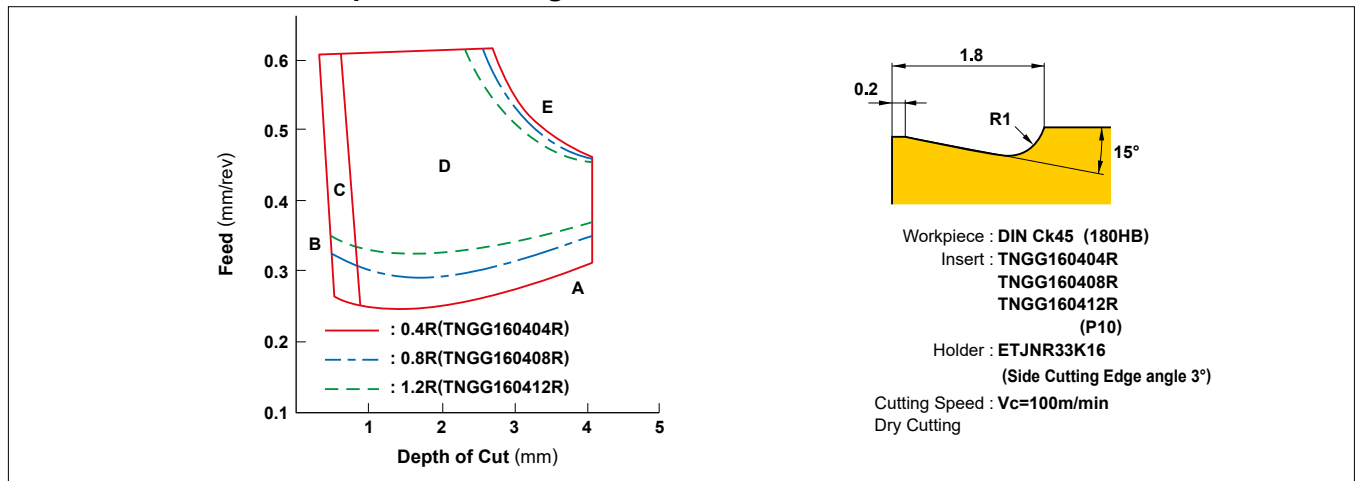

Note 1) Please refer to page P008 for chip shapes (A, B, C, D, E).

FORMULAE FOR CUTTING POWER

■ CUTTING POWER (Pc)

$$P_c = \frac{a_p \cdot f \cdot V_c \cdot K_c}{60 \times 10^3 \cdot \eta} \text{ (kW)}$$

P_c (kW) : Actual Cutting Power
f (mm/rev) : Feed per Revolution
K_c (MPa) : Specific Cutting Force

a_p (mm) : Depth of Cut
V_c (m/min) : Cutting Speed
η : (Machine Coefficient)

(Example) What is the cutting power required for machining mild steel at cutting speed 120m/min with depth of cut 3mm and feed 0.2mm/rev (Machine coefficient 80%) ? (Answer) Substitute the specific cutting force K_c=3100MPa into the formula.

$$P_c = \frac{3 \times 0.2 \times 120 \times 3100}{60 \times 10^3 \times 0.8} = 4.65 \text{ (kW)}$$

● K_c

Work Material	Tensile Strength(MPa) and Hardness	Specific Cutting Force K _c (MPa)				
		0.1 (mm/rev)	0.2 (mm/rev)	0.3 (mm/rev)	0.4 (mm/rev)	0.6 (mm/rev)
Mild Steel	520	3610	3100	2720	2500	2280
Medium Steel	620	3080	2700	2570	2450	2300
Hard Steel	720	4050	3600	3250	2950	2640
Tool Steel	670	3040	2800	2630	2500	2400
Tool Steel	770	3150	2850	2620	2450	2340
Chrome Manganese Steel	770	3830	3250	2900	2650	2400
Chrome Manganese Steel	630	4510	3900	3240	2900	2630
Chrome Molybdenum Steel	730	4500	3900	3400	3150	2850
Chrome Molybdenum Steel	600	3610	3200	2880	2700	2500
Nickel Chrome Molybdenum Steel	900	3070	2650	2350	2200	1980
Nickel Chrome Molybdenum Steel	352HB	3310	2900	2580	2400	2200
Hard Cast Iron	46HRC	3190	2800	2600	2450	2270
Meehanite Cast Iron	360	2300	1930	1730	1600	1450
Grey Cast Iron	200HB	2110	1800	1600	1400	1330

■ CUTTING SPEED (V_c)

$$V_c = \frac{\pi \cdot D_m \cdot n}{1000} \text{ (m/min)}$$

V_c (m/min) : Cutting Speed
D_m (mm) : Workpiece Diameter
π (3.14) : Pi
n (min⁻¹) : Main Axis Spindle Speed

*Divide by 1000 to change to m from mm.

(Example) What is the cutting speed when main axis spindle speed is 700min⁻¹ and external diameter is φ50 ?

(Answer) Substitute π=3.14, D_m=50, n=700 into the formula.

$$V_c = \frac{\pi \cdot D_m \cdot n}{1000} = \frac{3.14 \times 50 \times 700}{1000} = 110 \text{ m/min}$$

Cutting speed is 110m/min.

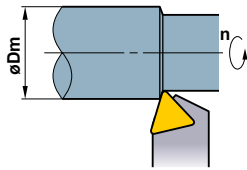

■ FEED (f)

$$f = \frac{l}{n} \text{ (mm/rev)}$$

f (mm/rev) : Feed per Revolution
l (mm/min) : Cutting Length per Min.
n (min⁻¹) : Main Axis Spindle Speed

(Example) What is the feed per revolution when main axis spindle speed is 500min⁻¹ and cutting length per minute is 120mm/min ?

(Answer) Substitute n=500, l=120 into the formula.

$$f = \frac{l}{n} = \frac{120}{500} = 0.24 \text{ mm/rev}$$

The answer is 0.24mm/rev.

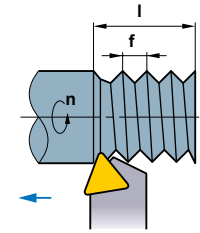

■ CUTTING TIME (T_c)

$$T_c = \frac{l_m}{l} \text{ (min)}$$

T_c (min) : Cutting Time
l_m (mm) : Workpiece Length
l (mm/min) : Cutting Length per Min.

(Example) What is the cutting time when 100mm workpiece is machined at 1000min⁻¹ with feed = 0.2mm/rev ?

(Answer) First, calculate the cutting length per min. from the feed and spindle speed.

$$l = f \cdot n = 0.2 \times 1000 = 200 \text{ mm/min}$$

Substitute the answer above into the formula.

$$T_c = \frac{l_m}{l} = \frac{100}{200} = 0.5 \text{ min}$$

0.5 x 60=30 (sec.) The answer is 30 sec.

■ THEORETICAL FINISHED SURFACE ROUGHNESS (h)

$$h = \frac{f^2}{8RE} \times 1000 \text{ (}\mu\text{m)}$$

h (μm) : Finished Surface Roughness
f (mm/rev) : Feed per Revolution
RE (mm) : Insert Corner Radius

(Example) What is the theoretical finished surface roughness when the insert corner radius is 0.8mm and feed is 0.2mm/rev ?

(Answer) Substitute f=0.2mm/rev, RE=0.8 into the formula.

$$h = \frac{0.2^2}{8 \times 0.8} \times 1000 = 6.25 \mu\text{m}$$

The theoretical finished surface roughness is 6μm.

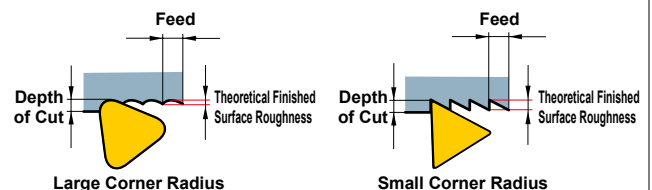

TROUBLE SHOOTING FOR THREADING

Problems	Observation	Causes	Solutions	
Low thread precision.	Threads do not mesh with each other.	Incorrect tool installation.	Set the insert centre height at 0mm.	
			Check holder inclination (Lateral).	
	Shallow thread.	Incorrect depth of cut.	Modify the depth of cut.	
		Lack of insert wear or plastic deformation resistance.	Refer to "Quickly generated flank wear." and "Large plastic deformation." below.	
Poor surface finish.	Surface damage.	Chips wrap around or clog the work pieces.	Change to flank infeed and control the chip discharge direction. Change to an M-class insert with a 3-D chipbreaker.	
		The side of the insert cutting edge interferes with the workpiece.	Check the lead angle and select an appropriate shim.	
		Surface tears.	Built-up edge (Welding).	Increase cutting speed. Increase coolant pressure and volume.
	Cutting resistance too high.		Decrease depth of cut per pass.	
	Surface vibrations.	Cutting speed too high.	Decrease the cutting speed.	
		Insufficient work piece or tool clamping.	Re-check work piece and tool clamping. (Chuck pressure, clamping allowance)	
		Incorrect tool installation.	Set the insert centre height at 0 mm.	
	Short tool life.	Flank wear quickly generated.	Cutting speed too high.	Decrease the cutting speed.
			Too many passes causes abrasive wear.	Reduce the number of passes.
			Small depth of cut for the finishing pass.	Do not re-cut at 0mm depth of cut, larger than 0.05mm depth of cut is recommended.
Non-uniform wear of the right and left sides of the cutting edge.		The work piece lead angle and the tool lead angle do not match.	Check the work piece lead angle and select an appropriate shim.	
Chipping and fracture.		Cutting speed too low.	Increase cutting speed.	
			Cutting resistance too high.	Increase the number of passes and decrease the cutting resistance per pass.
		Unstable clamping.		Check work piece deflection. Shorten tool overhang. Re-check work piece and tool clamping. (Chuck pressure, clamping allowance)
				Chip packing.
		Non-chamfered work pieces causes high resistance at the start of each pass.	Chamfer the workpiece entry and exit faces.	
		Large plastic deformation.	High cutting speed and large heat generation.	Decrease the cutting speed.
			Lack of coolant supply.	Check coolant supply is sufficient. Increase coolant pressure and volume.
Cutting resistance too high.				Increase the number of passes and decrease the cutting resistance per pass.

P

TECHNICAL DATA

THREADING METHODS

THREADING METHODS

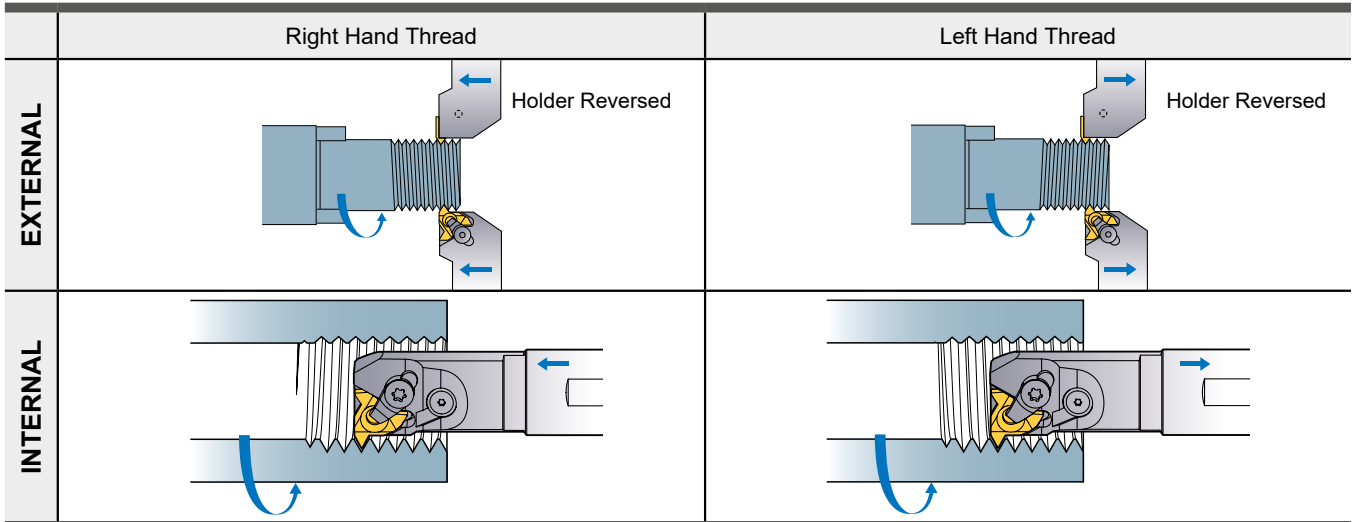

INSERT TYPES

Partial Form	Full Form	Semi-Full Form (Trapezoidal threads only)
<ul style="list-style-type: none"> ● The same insert can be used for a range of pitches. ● Shorter tool life because the nose radius of the insert is smaller than that of the full form insert. ● Finishing with another operation is necessary. 	<ul style="list-style-type: none"> ● No deburring needed after threading. ● Requires different threading inserts. 	<ul style="list-style-type: none"> ● No deburring needed after threading. ● Requires different threading inserts. ● Finishing with another operation is necessary.
<p>Crest Radius (Additional turning necessary to finish the thread crest.)</p> <p>Pre-finished Surface</p> <p>Finished Surface</p> <p>Feed Direction</p> <p>Insert</p>	<p>Crest Radius (Wiped/finished surface.)</p> <p>Pre-finished Surface</p> <p>Finished Surface</p> <p>Finishing allowance</p> <p>Feed Direction</p> <p>Insert</p>	<p>Crest Radius (Additional turning necessary to finish the thread crest.)</p> <p>Pre-finished Surface</p> <p>Finished Surface</p> <p>Feed Direction</p> <p>Insert</p>

INFEEED METHODS

	Radial Infeed	Flank Infeed	Modified Flank Infeed	Incremental Infeed
	<p>Radial Infeed</p>	<p>Flank Infeed</p>	<p>Modified Flank Infeed</p>	<p>Incremental Infeed</p>
Features	Advantages	<ul style="list-style-type: none"> ● Relatively easy to use. (Semi-standard programme for threading.) ● Reduced cutting force. ● Suitable for large pitch threads or materials that peel easily. ● Good chip discharge. 	<ul style="list-style-type: none"> ● Preventing flank wear on the right side of the cutting edge. ● Reduced cutting force. ● Suitable for large pitch threads or materials that peel easily. ● Good chip discharge. 	<ul style="list-style-type: none"> ● Uniform flank wear of the right and left sides of the cutting edge. ● Reduced cutting force. ● Suitable for large pitch threads or materials that peel easily.
	Disadvantages	<ul style="list-style-type: none"> ● Easiest to use. (Standard programme for threading) ● Wide application. (Cutting conditions easy to change.) ● Uniform wear of the right and left sides of the cutting edge. 	<ul style="list-style-type: none"> ● Large flank wear on the right side of the cutting edge. ● Relatively difficult to change cutting depth. (Re-programming necessary) 	<ul style="list-style-type: none"> ● Complex machining programming. ● Difficult to change cutting depth. (Re-programming necessary)

THREADING METHODS

THREADING DEPTH

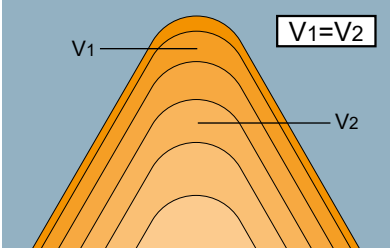
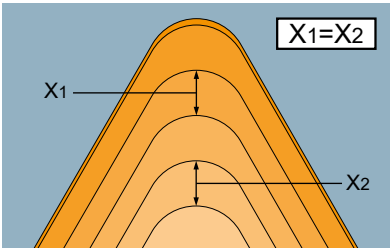
		Features	
		Advantages	Disadvantages
 <p>Fixed cut area</p>	<ul style="list-style-type: none"> ● Easy to use. (Standard programme for threading.) ● Superior resistance to vibration. (Constant cutting force.) 	<ul style="list-style-type: none"> ● Long chips generated during the final pass. ● Complex calculation of cutting depth when changing the number of passes. 	
 <p>Fixed cutting depth</p>	<ul style="list-style-type: none"> ● Reduced load on nose radius during the first half of the passes. ● Easy chip control. (Optional setting of chip thickness) ● Easy to calculate cutting depth when changing the number of passes. ● Good chip control. 	<ul style="list-style-type: none"> ● Subject to vibration in the later stages of cutting. (Increased cutting force) ● In some cases, changing the NC programme is necessary. 	

Note 1) It is recommended to set the depth of cut of the final pass to 0.05mm–0.025mm. Large cutting depths can cause vibration, leading to a poor surface finish.

■ FORMULAE

● Formulae to calculate infeed for each pass in a reduced series.

$\Delta ap_n = \frac{ap}{\sqrt{n_{ap}-1}} \times \sqrt{b}$	<p>(Example) External threading (ISO Metric) Pitch : 1.0mm ap : 0.6mm n_{ap} : 5 passes</p> <p>1st Pass $\Delta ap_1 = \frac{0.60}{\sqrt{5-1}} \times \sqrt{0.3} = 0.16 \rightarrow \mathbf{0.16} (\Delta ap_1)$</p> <p>2nd Pass $\Delta ap_2 = \frac{0.60}{\sqrt{5-1}} \times \sqrt{2-1} = 0.3 \rightarrow \mathbf{0.14} (\Delta ap_2 - \Delta ap_1)$</p> <p>3rd Pass $\Delta ap_3 = \frac{0.60}{\sqrt{5-1}} \times \sqrt{3-1} = 0.42 \rightarrow \mathbf{0.12} (\Delta ap_3 - \Delta ap_2)$</p> <p>4th Pass $\Delta ap_4 = \frac{0.60}{\sqrt{5-1}} \times \sqrt{4-1} = 0.52 \rightarrow \mathbf{0.1} (\Delta ap_4 - \Delta ap_3)$</p> <p>5th Pass $\Delta ap_5 = \frac{0.60}{\sqrt{5-1}} \times \sqrt{5-1} = 0.6 \rightarrow \mathbf{0.08} (\Delta ap_5 - \Delta ap_4)$</p>
<p>Δap_n : Depth of cut n : Actual pass ap : Total depth of cut n_{ap} : Number of passes b : 1st pass 0.3 2nd pass 2-1 = 1 3rd pass 3-1 = 2 . . nth pass n-1</p>	

■ NC PROGRAMME FOR MODIFIED FLANK INFEEED

● Example: M12×1.0 5 passes modified 5°

External Threading	Internal Threading
G00 Z = 5.0 X = 14.0	G00 Z = 5.0 X = 10.0
G92 U - 4.34 Z - 13.0 F1.0	G92 U4.34 Z - 13.0 F1.0
G00 W - 0.07	G00 W - 0.07
G92 U - 4.64 Z - 13.0 F1.0	G92 U4.64 Z - 13.0 F1.0
G00 W - 0.06	G00 W - 0.05
G92 U - 4.88 Z - 13.0 F1.0	G92 U4.84 Z - 13.0 F1.0
G00 W - 0.05	G00 W - 0.04
G92 U - 5.08 Z - 13.0 F1.0	G92 U5.02 Z - 13.0 F1.0
G00 W - 0.03	G00 W - 0.03
G92 U - 5.20 Z - 13.0 F1.0	G92 U5.14 Z - 13.0 F1.0
G00	G00

SELECTING CUTTING CONDITIONS

		Priority					
		Tool Life	Cutting Force	Surface Finish	Precision of Thread	Chips Discharge	Efficiency (Reduced Passes)
Threading Methods	Radial	○		○	○		○
	Flank	(△ : Modified)	○	(△ : Modified)		○	
Cutting Depth	Fixed Cutting Depth					○	
	Fixed Cut Area	○	○	○	○		○

Note 1) Tool life and surface finish accuracy can be increased by changing the threading method from flank infeed to modified flank infeed. Chip control can be improved by increasing the cutting depth in the later half of passes.

CUTTING DEPTH AND THE NUMBER OF PASSES

● Selection of the appropriate cutting depth and the right number of passes is vital for threading.

- For most threading, use a "threading cycle program," which has originally been installed on machines, and specify "total cutting depth" and "cutting depth in the first or final pass."
- Cutting depth and the number of passes are easy to change for the radial infeed method, thus making it easy to determine the appropriate cutting conditions.

FEATURES AND BENEFITS OF MITSUBISHI PRODUCTS

- Insert grades with high wear and plastic deformation resistance, specially produced for threading tools, ensure highly efficient cutting by enabling high-speed machining and a reduced number of passes.

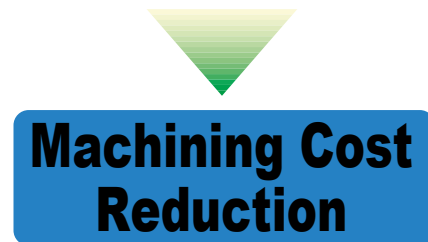

ADVICE ON IMPROVED THREADING

● Increasing tool life

- To prevent damage to the nose radius - Recommended method - Modified flank infeed
- To have uniform flank wear on both sides of a cutting edge - Recommended method - Radial infeed
- To prevent crater wear - Recommended method - Flank infeed

● Preventing chip problems

- Change to flank or modified infeed.
- During radial infeed cutting, use an inverted holder and change the coolant supply to a downward direction.
- When using the radial infeed method, set the minimum cutting depth at around 0.2mm to make the chips thicker.

● To achieve highly efficient machining

- Increase cutting speed. (Dependant on the maximum revolution and rigidity of the machine.)
- Reduce the number of passes. (Reduce by 30-40%.)
- A reduced number of passes can improve chip discharge because of the thicker chips generated.

● Preventing vibration

- Change to flank or modified infeed.
- When using radial infeed, reduce cutting depth in the later half of passes and lower the cutting speed.

● Increased surface finish accuracy

- A final wiping pass should be performed at the same depth of cut as the last regular pass.
- When using the flank infeed method, change to radial infeed only during the final pass.

METALLIC MATERIALS CROSS REFERENCE LIST

■ CARBON STEEL

Germany		U.K.		France	Italy	Spain	Sweden	Japan	USA	China
W-nr.	DIN	BS	EN	AFNOR	UNI	UNE	SS	JIS	AISI/SAE	GB
1.0038	RSt.37-2	4360 40 C	–	E 24-2 Ne	–	–	1311	STKM 12A STKM 12C	A570.36	15
1.0401	C15	080M15	–	CC12	C15, C16	F.111	1350	–	1015	15
1.0402	C22	050A20	2C	CC20	C20, C21	F.112	1450	–	1020	20
1.0715	9SMn28	230M07	1A	S250	CF9SMn28	F.2111 11SMn28	1912	SUM22	1213	Y15
1.0718	9SMnPb28	–	–	S250Pb	CF9SMnPb28	11SMnPb28	1914	SUM22L	12L13	–
1.0722	10SPb20	–	–	10PbF2	CF10Pb20	10SPb20	–	–	–	–
1.0736	9SMn36	240M07	1B	S300	CF9SMn36	12SMn35	–	–	1215	Y13
1.0737	9SMnPb36	–	–	S300Pb	CF9SMnPb36	12SMnP35	1926	–	12L14	–
1.1141	Ck15	080M15	32C	XC12	C16	C15K	1370	S15C	1015	15
1.1158	Ck25	–	–	–	–	–	–	S25C	1025	25
1.8900	StE380	4360 55 E	–	–	FeE390KG	–	2145	–	A572-60	–
1.0501	C35	060A35	–	CC35	C35	F.113	1550	–	1035	35
1.0503	C45	080M46	–	CC45	C45	F.114	1650	–	1045	45
1.0726	35S20	212M36	8M	35MF4	–	F210G	1957	–	1140	–
1.1157	40Mn4	150M36	15	35M5	–	–	–	–	1039	40Mn
1.1167	36Mn5	–	–	40M5	–	36Mn5	2120	SMn438(H)	1335	35Mn2
1.1170	28Mn6	150M28	14A	20M5	C28Mn	–	–	SCMn1	1330	30Mn
1.1183	Cf35	060A35	–	XC38TS	C36	–	1572	S35C	1035	35Mn
1.1191	Ck45	080M46	–	XC42	C45	C45K	1672	S45C	1045	Ck45
1.1213	Cf53	060A52	–	XC48TS	C53	–	1674	S50C	1050	50
1.0535	C55	070M55	9	–	C55	–	1655	–	1055	55
1.0601	C60	080A62	43D	CC55	C60	–	–	–	1060	60
1.1203	Ck55	070M55	–	XC55	C50	C55K	–	S55C	1055	55
1.1221	Ck60	080A62	43D	XC60	C60	–	1678	S58C	1060	60Mn
1.1274	Ck101	060A96	–	XC100	–	F.5117	1870	–	1095	–
1.1545	C105W1	BW1A	–	Y105	C36KU	F.5118	1880	SK3	W1	–
1.1545	C105W1	BW2	–	Y120	C120KU	F.515	2900	SUP4	W210	–

■ ALLOY STEEL

Germany		U.K.		France	Italy	Spain	Sweden	Japan	USA	China
W-nr.	DIN	BS	EN	AFNOR	UNI	UNE	SS	JIS	AISI/SAE	GB
1.0144	St.44.2	4360 43 C	–	E28-3	–	–	1412	SM400A, SM400B SM400C	A573-81	–
1.0570	St52-3	4360 50 B	–	E36-3	Fe52BFN Fe52CFN	–	2132	SM490A, SM490B SM490C	–	–
1.0841	St52-3	150M19	–	20MC5	Fe52	F.431	2172	–	5120	–
1.0904	55Si7	250A53	45	55S7	55Si8	56Si7	2085	–	9255	55Si2Mn
1.0961	60SiCr7	–	–	60SC7	60SiCr8	60SiCr8	–	–	9262	–
1.3505	100Cr6	534A99	31	100C6	100Cr6	F.131	2258	SUJ2	ASTM 52100	Gr15, 45G
1.5415	15Mo3	1501-240	–	15D3	16Mo3KW	16Mo3	2912	–	ASTM A204Gr.A	–
1.5423	16Mo5	1503-245-420	–	–	16Mo5	16Mo5	–	–	4520	–
1.5622	14Ni6	–	–	16N6	14Ni6	15Ni6	–	–	ASTM A350LF5	–
1.5662	X8Ni9	1501-509-510	–	–	X10Ni9	XBNI09	–	–	ASTM A353	–
1.5710	36NiCr6	640A35	111A	35NC6	–	–	–	SNC236	3135	–
1.5732	14NiCr10	–	–	14NC11	16NiCr11	15NiCr11	–	SNC415(H)	3415	–
1.5752	14NiCr14	655M13	36A	12NC15	–	–	–	SNC815(H)	3415, 3310	–
1.6523	21NiCrMo2	805M20	362	20NCD2	20NiCrMo2	20NiCrMo2	2506	SNCM220(H)	8620	–
1.6546	40NiCrMo22	311-Type 7	–	–	40NiCrMo2(KB)	40NiCrMo2	–	SNCM240	8740	–
1.6587	17CrNiMo6	820A16	–	18NCD6	–	14NiCrMo13	–	–	–	–
1.7015	15Cr3	523M15	–	12C3	–	–	–	SCr415(H)	5015	15Cr

Germany		U.K.		France	Italy	Spain	Sweden	Japan	USA	China
W-nr.	DIN	BS	EN	AFNOR	UNI	UNE	SS	JIS	AISI/SAE	GB
1.7045	42Cr4	–	–	–	–	42Cr4	2245	SCr440	5140	40Cr
1.7176	55Cr3	527A60	48	55C3	–	–	–	SUP9(A)	5155	20CrMn
1.7262	15CrMo5	–	–	12CD4	–	12CrMo4	2216	SCM415(H)	–	–
1.7335	13CrMo4 4	1501-620Gr27	–	15CD3.5 15CD4.5	14CrMo45	14CrMo45	–	–	ASTM A182 F11, F12	–
1.7380	10CrMo910	1501-622 Gr31, 45	–	12CD9 12CD10	12CrMo9 12CrMo10	TU.H	2218	–	ASTM A182 F.22	–
1.7715	14MoV63	1503-660-440	–	–	–	13MoCrV6	–	–	–	–
1.8523	39CrMoV13 9	897M39	40C	–	36CrMoV12	–	–	–	–	–
1.6511	36CrNiMo4	816M40	110	40NCD3	38NiCrMo4(KB)	35NiCrMo4	–	–	9840	–
1.6582	34CrNiMo6	817M40	24	35NCD6	35NiCrMo6(KB)	–	2541	–	4340	40CrNiMoA
1.7033	34Cr4	530A32	18B	32C4	34Cr4(KB)	35Cr4	–	SCr430(H)	5132	35Cr
1.7035	41Cr4	530M40	18	42C4	41Cr4	42Cr4	–	SCr440(H)	5140	40Cr
1.7131	16MnCr5	(527M20)	–	16MC5	16MnCr5	16MnCr5	2511	–	5115	18CrMn
1.7218	25CrMo4	1717CDS110 708M20	–	25CD4	25CrMo4(KB)	55Cr3	2225	SCM420 SCM430	4130	30CrMn
1.7220	34CrMo4	708A37	19B	35CD4	35CrMo4	34CrMo4	2234	SCM432 SCCRM3	4137 4135	35CrMo
1.7223	41CrMo4	708M40	19A	42CD4TS	41CrMo4	42CrMo4	2244	SCM 440	4140 4142	40CrMoA
1.7225	42CrMo4	708M40	19A	42CD4	42CrMo4	42CrMo4	2244	SCM440(H)	4140	42CrMo 42CrMnMo
1.7361	32CrMo12	722M24	40B	30CD12	32CrMo12	F.124.A	2240	–	–	–
1.8159	50CrV4	735A50	47	50CV4	50CrV4	51CrV4	2230	SUP10	6150	50CrVA
1.8509	41CrAlMo7	905M39	41B	40CAD6 40CAD2	41CrAlMo7	41CrAlMo7	2940	–	–	–
1.2067	100Cr6	BL3	–	Y100C6	–	100Cr6	–	–	L3	CrV, 9SiCr
1.2419	105WCr6	–	–	105WC13	100WCr6 107WCr5KU	105WCr5	2140	SKS31 SKS2, SKS3	–	CrWMo
1.2713	55NiCrMoV6	BH224/5	–	55NCDV7	–	F.520.S	–	SKT4	L6	5CrNiMo
1.5662	X8Ni9	1501-509	–	–	X10Ni9	XBNI09	–	–	ASTM A353	–
1.5680	12Ni19	–	–	Z18N5	–	–	–	–	2515	–
1.6657	14NiCrMo134	832M13	36C	–	15NiCrMo13	14NiCrMo131	–	–	–	–
1.2080	X210Cr12	BD3	–	Z200C12	X210Cr13KU X250Cr12KU	X210Cr12	–	SKD1	D3 ASTM D3	Cr12
1.2601	X153CrMoV12	BD2	–	–	X160CrMoV12	–	–	SKD11	D2	Cr12MoV
1.2363	X100CrMoV5	BA2	–	Z100CDV5	X100CrMoV5	F.5227	2260	SKD12	A2	Cr5Mo1V
1.2344	X40CrMoV51 X40CrMoV51	BH13	–	Z40CDV5	X35CrMoV05KU X40CrMoV51KU	X40CrMoV5	2242	SKD61	H13 ASTM H13	40CrMoV5
1.2436	X210CrW12	–	–	–	X215CrW121KU	X210CrW12	2312	SKD2	–	–
1.2542	45WCrV7	BS1	–	–	45WCrV8KU	45WCrSi8	2710	–	S1	–
1.2581	X30WCrV93	BH21	–	Z30WCV9	X28W09KU	X30WCrV9	–	SKD5	H21	30WCrV9
1.2601	X165CrMoV12	–	–	–	X165CrMoV12KU	X160CrMoV12	2310	–	–	–
1.2833	100V1	BW2	–	Y1105V	–	–	–	SKS43	W210	V
1.3255	S 18-1-2-5	BT4	–	Z80WKCV	X78WCo1805KU	HS18-1-1-5	–	SKH3	T4	W18Cr4VCo5
1.3355	S 18-0-1	BT1	–	Z80WCV	X75W18KU	HS18-0-1	–	SKH2	T1	–
1.3401	G-X120Mn12	Z120M12	–	Z120M12	XG120Mn12	X120MN12	–	SCMnH/1	–	–
1.4718	X45CrSi93	401S45	52	Z45CS9	X45CrSi8	F.322	–	SUH1	HW3	X45CrSi93
1.3343	S6-5-2	4959BA2	–	Z40CSD10	15NiCrMo13	–	2715	SUH3	D3	–
1.3343	S6/5/2	BM2	–	Z85WDCV	HS6-5-2-2	F.5603	2722	SKH9, SKH51	M2	–
1.3348	S 2-9-2	–	–	–	HS2-9-2	HS2-9-2	2782	–	M7	–
1.3243	S6/5/2/5	BM35	–	6-5-2-5	HS6-5-2-5	F.5613	2723	SKH55	M35	–

TECHNICAL DATA

METALLIC MATERIALS CROSS REFERENCE LIST

■ STAINLESS STEEL (FERRITIC, MARTENSITIC)

Germany		U.K.		France	Italy	Spain	Sweden	Japan	USA	China
W-nr.	DIN	BS	EN	AFNOR	UNI	UNE	SS	JIS	AISI/SAE	GB
1.4000	X7Cr13	403S17	–	Z6C13	X6Cr13	F.3110	2301	SUS403	403	OCr13 1Cr12
1.4001	X7Cr14	–	–	–	–	F.8401	–	–	–	–
1.4005	X12CrS13	416S21	–	Z11CF13	X12CrS13	F.3411	2380	SUS416	416	–
1.4006	X10Cr13	410S21	56A	Z10C14	X12Cr13	F.3401	2302	SUS410	410	1Cr13
1.4016	X8Cr17	430S15	60	Z8C17	X8Cr17	F.3113	2320	SUS430	430	1Cr17
1.4027	G-X20Cr14	420C29	56B	Z20C13M	–	–	–	SCS2	–	–
1.4034	X46Cr13	420S45	56D	Z40CM Z38C13M	X40Cr14	F.3405	2304	SUS420J2	–	4Cr13
1.4003	–	405S17	–	Z8CA12	X6CrAl13	–	–	–	405	–
1.4021	–	420S37	–	Z8CA12	X20Cr13	–	2303	–	420	–
1.4057	X22CrNi17	431S29	57	Z15CNi6.02	X16CrNi16	F.3427	2321	SUS431	431	1Cr17Ni2
1.4104	X12CrMoS17	–	–	Z10CF17	X10CrS17	F.3117	2383	SUS430F	430F	Y1Cr17
1.4113	X6CrMo17	434S17	–	Z8CD17.01	X8CrMo17	–	2325	SUS434	434	1Cr17Mo
1.4313	X5CrNi134	425C11	–	Z4CND13.4M	(G)X6CrNi304	–	2385	SCS5	CA6-NM	–
1.4724	X10CrA113	403S17	–	Z10C13	X10CrA112	F.311	–	SUS405	405	OCr13Al
1.4742	X10CrA118	430S15	60	Z10CAS18	X8Cr17	F.3113	–	SUS430	430	Cr17
1.4747	X80CrNiSi20	443S65	59	Z80CSN20.02	X80CrSiNi20	F.320B	–	SUH4	HNV6	–
1.4762	X10CrA124	–	–	Z10CAS24	X16Cr26	–	2322	SUH446	446	2Cr25N
1.4871	X53CrMnNiN219	349S54	–	Z52CMN21.09	X53CrMnNiN219	–	–	SUH35	EV8	5Cr2Mn9Ni4N
1.4521	X1CrMoTi182	–	–	–	–	–	2326	–	S44400	–
1.4922	X20CrMoV12-1	–	–	–	X20CrMoNi1201	–	2317	–	–	–
1.4542	–	–	–	Z7CNU17-04	–	–	–	–	630	–

■ STAINLESS STEEL (AUSTENITIC)

Germany		U.K.		France	Italy	Spain	Sweden	Japan	USA	China
W-nr.	DIN	BS	EN	AFNOR	UNI	UNE	SS	JIS	AISI/SAE	GB
1.4306	X2CrNi1911	304S11	–	Z2CN18.10	X2CrNi18.11	–	2352	SUS304L	304L	OCr19Ni10
1.4350	X5CrNi189	304S11	58E	Z6CN18.09	X5CrNi1810	F.3551 F.3541 F.3504	2332	SUS304	304	OCr18Ni9
1.4305	X12CrNiS188	303S21	58M	Z10CNF18.09	X10CrNiS18.09	F.3508	2346	SUS303	303	1Cr18Ni9MoZr
–	–	304C12	–	Z3CN19.10	–	–	2333	SUS304L	–	–
1.4306	X2CrNi189	304S12	–	Z2CrNi1810	X2CrNi18.11	F.3503	2352	SCS19	304L	–
1.4310	X12CrNi177	–	–	Z12CN17.07	X12CrNi1707	F.3517	2331	SUS301	301	Cr17Ni7
1.4311	X2CrNiN1810	304S62	–	Z2CN18.10	–	–	2371	SUS304LN	304LN	–
1.4401	X5CrNiMo1810	316S16	58J	Z6CND17.11	X5CrNiMo1712	F.3543	2347	SUS316	316	OCr17Ni11Mo2
1.4308	G-X6CrNi189	304C15	–	Z6CN18.10M	–	–	–	SCS13	–	–
1.4408	G-X6CrNiMo1810	316C16	–	–	–	F.8414	–	SCS14	–	–
1.4581	G-X5CrNiMoNb1810	318C17	–	Z4CNDNb1812M	XG8CrNiMo1811	–	–	SCS22	–	–
1.4429	X2CrNiMoN1813	–	–	Z2CND17.13	–	–	2375	SUS316LN	316LN	OCr17Ni13Mo
1.4404	–	316S13	–	Z2CND17.12	X2CrNiMo1712	–	2348	–	316L	–
1.4435	X2CrNiMo1812	316S13	–	Z2CND17.12	X2CrNiMo1712	–	2353	SCS16 SUS316L	316L	OCr27Ni12Mo3
1.4436	–	316S13	–	Z6CND18-12-03	X8CrNiMo1713	–	2343, 2347	–	316	–
1.4438	X2CrNiMo1816	317S12	–	Z2CND19.15	X2CrNiMo1816	–	2367	SUS317L	317L	OCr19Ni13Mo
1.4539	X1NiCrMo	–	–	Z6CNT18.10	–	–	2562	–	UNS V 0890A	–
1.4541	X10CrNiTi189	321S12	58B	Z6CNT18.10	X6CrNiTi1811	F.3553 F.3523	2337	SUS321	321	1Cr18Ni9Ti
1.4550	X10CrNiNb189	347S17	58F	Z6CNNb18.10	X6CrNiNb1811	F.3552 F.3524	2338	SUS347	347	1Cr18Ni11Nb
1.4571	X10CrNiMoTi1810	320S17	58J	Z6CNDT17.12	X6CrNiMoTi1712	F.3535	2350	–	316Ti	Cr18Ni12Mo2T
1.4583	X10CrNiMoNb1812	–	–	Z6CNDNb1713B	X6CrNiMoNb1713	–	–	–	318	Cr17Ni12Mo3Mb

Germany		U.K.		France	Italy	Spain	Sweden	Japan	USA	China
W-nr.	DIN	BS	EN	AFNOR	UNI	UNE	SS	JIS	AISI/SAE	GB
1.4828	X15CrNiSi2012	309S24	–	Z15CNS20.12	X6CrNi2520	–	–	SUH309	309	1Cr23Ni13
1.4845	X12CrNi2521	310S24	–	Z12CN2520	X6CrNi2520	F.331	2361	SUH310	310S	OCr25Ni20
1.4406	X10CrNi18.08	–	58C	Z1NCDU25.20	–	F.8414	2370	SCS17	308	–
1.4418	X4CrNiMo165	–	–	Z6CND16-04-01	–	–	–	–	–	–
1.4568	–	316S111	–	Z8CNA17-07	X2CrNiMo1712	–	–	–	17-7PH	–
1.4504	–	–	–	–	–	–	–	–	–	–
1.4563	–	–	–	Z1NCDU31-27-03 Z1CNDU20-18-06AZ	–	–	2584 2378	–	NO8028 S31254	–
1.4878	X12CrNiTi189	321S32	58B, 58C	Z6CNT18.12B	X6CrNiTi18.11	F.3523	–	SUS321	321	1Cr18Ni9Ti

HEAT RESISTANT STEELS

Germany		U.K.		France	Italy	Spain	Sweden	Japan	USA	China
W-nr.	DIN	BS	EN	AFNOR	UNI	UNE	SS	JIS	AISI/SAE	GB
1.4864	X12NiCrSi3616	–	–	Z12NCS35.16	–	–	–	SUH330	330	–
1.4865	G-X40NiCrSi3818	330C11	–	–	XG50NiCr3919	–	–	SCH15	HT, HT 50	–

GRAY CAST IRON

Germany		U.K.		France	Italy	Spain	Sweden	Japan	USA	China
W-nr.	DIN	BS	EN	AFNOR	UNI	UNE	SS	JIS	AISI/SAE	GB
–	–	–	–	–	–	–	0100	–	–	–
–	GG 10	–	–	Ft 10 D	–	–	0110	FC100	No 20 B	–
0.6015	GG 15	Grade 150	–	Ft 15 D	G15	FG15	0115	FC150	No 25 B	HT150
0.6020	GG 20	Grade 220	–	Ft 20 D	G20	–	0120	FC200	No 30 B	HT200
0.6025	GG 25	Grade 260	–	Ft 25 D	G25	FG25	0125	FC250	No 35 B	HT250
–	–	–	–	–	–	–	–	–	No 40 B	–
0.6030	GG 30	Grade 300	–	Ft 30 D	G30	FG30	0130	FC300	No 45 B	HT300
0.6035	GG 35	Grade 350	–	Ft 35 D	G35	FG35	0135	FC350	No 50 B	HT350
0.6040	GG 40	Grade 400	–	Ft 40 D	–	–	0140	–	No 55 B	HT400
0.6660	GGL NiCr202	L-NiCuCr202	–	L-NC 202	–	–	0523	–	A436 Type 2	–

DUCTILE CAST IRON

Germany		U.K.		France	Italy	Spain	Sweden	Japan	USA	China
W-nr.	DIN	BS	EN	AFNOR	UNI	UNE	SS	JIS	AISI/SAE	GB
0.7040	GGG 40	SNG 420/12	–	FCS 400-12	GS 370-17	FGE 38-17	07 17-02	FCD400	60-40-18	QT400-18
–	GGG 40.3	SNG 370/17	–	FGS 370-17	–	–	07 17-12	–	–	–
0.7033	GGG 35.3	–	–	–	–	–	07 17-15	–	–	–
0.7050	GGG 50	SNG 500/7	–	FGS 500-7	GS 500	FGE 50-7	07 27-02	FCD500	80-55-06	QT500-7
0.7660	GGG NiCr202	Grade S6	–	S-NC202	–	–	07 76	–	A43D2	–
–	GGG NiMn137	L-NiMn 137	–	L-MN 137	–	–	07 72	–	–	–
–	GGG 60	SNG 600/3	–	FGS 600-3	–	–	07 32-03	FCD600	–	QT600-3
0.7070	GGG 70	SNG 700/2	–	FGS 700-2	GS 700-2	FGE 70-2	07 37-01	FCD700	100-70-03	QT700-18

MALLEABLE CAST IRON

Germany		U.K.		France	Italy	Spain	Sweden	Japan	USA	China
W-nr.	DIN	BS	EN	AFNOR	UNI	UNE	SS	JIS	AISI/SAE	GB
–	–	8 290/6	–	MN 32-8	–	–	08 14	FCMB310	–	–
–	GTS-35	B 340/12	–	MN 35-10	–	–	08 15	FCMW330	32510	–
0.8145	GTS-45	P 440/7	–	Mn 450	GMN45	–	08 52	FCMW370	40010	–
0.8155	GTS-55	P 510/4	–	MP 50-5	GMN55	–	08 54	FCMP490	50005	–
–	GTS-65	P 570/3	–	MP 60-3	–	–	08 58	FCMP540	70003	–
0.8165	GTS-65-02	P 570/3	–	Mn 650-3	GMN 65	–	08 56	FCMP590	A220-70003	–
–	GTS-70-02	P 690/2	–	Mn 700-2	GMN 70	–	08 62	FCMP690	A220-80002	–

SURFACE ROUGHNESS

SURFACE ROUGHNESS

(From JIS B 0601-1994)

Type	Code	Determination	Determination Example (Figure)
Arithmetical Mean Roughness	Ra	<p>Ra means the value obtained by the following formula and expressed in micrometer (μm) when sampling only the reference length from the roughness curve in the direction of the mean line, taking X-axis in the direction of mean line and Y-axis in the direction of longitudinal magnification of this sampled part and the roughness curve is expressed by $y=f(x)$:</p> $Ra = \frac{1}{l} \int_0^l f(x) dx$	
Maximum Height	Rz	<p>Rz shall be that only when the reference length is sampled from the roughness curve in the direction of the mean line, the distance between the top profile peak line and the bottom profile valley line on this sampled portion is measured in the longitudinal magnification direction of roughness curve and the obtained value is expressed in micrometer (μm).</p> <p>Note: When finding Rz, a portion without an exceptionally high peak or low valley, which may be regarded as a flaw, is selected as the sampling length.</p> $Rz = R_p + R_v$	
Ten-Point Mean Roughness	RzJIS	<p>RzJIS shall be that only when the reference length is sampled from the roughness curve in the direction of its mean line, the sum of the average value of absolute values of the heights of five highest profile peaks (Y_p) and the depths of five deepest profile valleys (Y_v) measured in the vertical magnification direction from the mean line of this sampled portion and this sum is expressed in micrometer (μm).</p> $Rz_{JIS} = \frac{(Y_{p1} + Y_{p2} + Y_{p3} + Y_{p4} + Y_{p5}) + (Y_{v1} + Y_{v2} + Y_{v3} + Y_{v4} + Y_{v5})}{5}$	<p>$Y_{p1}, Y_{p2}, Y_{p3}, Y_{p4}, Y_{p5}$: altitudes of the five highest profile peaks of the sampled portion corresponding to the reference length l.</p> <p>$Y_{v1}, Y_{v2}, Y_{v3}, Y_{v4}, Y_{v5}$: altitudes of the five deepest profile valleys of the sampled portion corresponding to the reference length l.</p>

RELATIONSHIP BETWEEN ARITHMETICAL MEAN (Ra) AND CONVENTIONAL DESIGNATION (REFERENCE DATA)

Arithmetical Mean Roughness Ra		Max. Height Rz	Ten-Point Mean Roughness RzJIS	Sampling Length for Rz • RzJIS l (mm)	Conventional Finish Mark
Standard Series	Cutoff Value λ_c (mm)	Standard Series			
0.012 a	0.08	0.05s	0.05z	0.08	▽▽▽▽
0.025 a		0.1 s	0.1 z		
0.05 a	0.25	0.2 s	0.2 z	0.25	
0.1 a		0.4 s	0.4 z		
0.2 a		0.8 s	0.8 z		
0.4 a	0.8	1.6 s	1.6 z	0.8	▽▽▽
0.8 a		3.2 s	3.2 z		
1.6 a		6.3 s	6.3 z		
3.2 a		12.5 s	12.5 z		
6.3 a	2.5	25 s	25 z	2.5	▽▽
12.5 a		50 s	50 z		
25 a	8	100 s	100 z	8	▽
50 a		200 s	200 z		
100 a		—	400 s		

Note 1) The correlation among the three is shown for convenience and is not exact.

Note 2) Ra: The evaluation length of Rz and RzJIS is the cutoff value and sampling length multiplied by 5, respectively.

HARDNESS COMPARISON TABLE

HARDNESS CONVERSION NUMBERS OF STEEL

Brinell Hardness (HB), 10mm Ball, Load: 3000kgf		Vickers Hardness	Rockwell Hardness				Shore Hardness	Tensile Strength (Approx.) MPa	Brinell Hardness (HB), 10mm Ball, Load: 3000kgf		Vickers Hardness	Rockwell Hardness				Shore Hardness	Tensile Strength (Approx.) MPa
Standard Ball	Tungsten Carbide Ball		A Scale, Load: 60kgf, Diamond Point	B Scale, Load: 100kgf, 1/16" Ball	C Scale, Load: 150kgf, Diamond Point	D Scale, Load: 100kgf, Diamond Point			Standard Ball	Tungsten Carbide Ball		A Scale, Load: 60kgf, Diamond Point	B Scale, Load: 100kgf, 1/16" Ball	C Scale, Load: 150kgf, Diamond Point	D Scale, Load: 100kgf, Diamond Point		
		(HV)	(HRA)	(HRB)	(HRC)	(HRD)	(HS)			(HV)	(HRA)	(HRB)	(HRC)	(HRD)	(HS)	MPa	
—	—	940	85.6	—	68.0	76.9	97	—	429	429	455	73.4	—	45.7	59.7	61	1510
—	—	920	85.3	—	67.5	76.5	96	—	415	415	440	72.8	—	44.5	58.8	59	1460
—	—	900	85.0	—	67.0	76.1	95	—	401	401	425	72.0	—	43.1	57.8	58	1390
—	(767)	880	84.7	—	66.4	75.7	93	—	388	388	410	71.4	—	41.8	56.8	56	1330
—	(757)	860	84.4	—	65.9	75.3	92	—	375	375	396	70.6	—	40.4	55.7	54	1270
—	(745)	840	84.1	—	65.3	74.8	91	—	363	363	383	70.0	—	39.1	54.6	52	1220
—	(733)	820	83.8	—	64.7	74.3	90	—	352	352	372	69.3	(110.0)	37.9	53.8	51	1180
—	(722)	800	83.4	—	64.0	73.8	88	—	341	341	360	68.7	(109.0)	36.6	52.8	50	1130
—	(712)	—	—	—	—	—	—	—	331	331	350	68.1	(108.5)	35.5	51.9	48	1095
—	(710)	780	83.0	—	63.3	73.3	87	—	321	321	339	67.5	(108.0)	34.3	51.0	47	1060
—	(698)	760	82.6	—	62.5	72.6	86	—	—	—	—	—	—	—	—	—	—
—	(684)	740	82.2	—	61.8	72.1	—	—	311	311	328	66.9	(107.5)	33.1	50.0	46	1025
—	(682)	737	82.2	—	61.7	72.0	84	—	302	302	319	66.3	(107.0)	32.1	49.3	45	1005
—	(670)	720	81.8	—	61.0	71.5	83	—	293	293	309	65.7	(106.0)	30.9	48.3	43	970
—	(656)	700	81.3	—	60.1	70.8	—	—	285	285	301	65.3	(105.5)	29.9	47.6	—	950
—	(653)	697	81.2	—	60.0	70.7	81	—	277	277	292	64.6	(104.5)	28.8	46.7	41	925
—	(647)	690	81.1	—	59.7	70.5	—	—	269	269	284	64.1	(104.0)	27.6	45.9	40	895
—	(638)	680	80.8	—	59.2	70.1	80	—	262	262	276	63.6	(103.0)	26.6	45.0	39	875
—	630	670	80.6	—	58.8	69.8	—	—	255	255	269	63.0	(102.0)	25.4	44.2	38	850
—	627	667	80.5	—	58.7	69.7	79	—	248	248	261	62.5	(101.0)	24.2	43.2	37	825
—	—	677	80.7	—	59.1	70.0	—	—	241	241	253	61.8	100	22.8	42.0	36	800
—	601	640	79.8	—	57.3	68.7	77	—	235	235	247	61.4	99.0	21.7	41.4	35	785
—	—	640	79.8	—	57.3	68.7	—	—	229	229	241	60.8	98.2	20.5	40.5	34	765
—	578	615	79.1	—	56.0	67.7	75	—	223	223	234	—	97.3	(18.8)	—	—	—
—	—	607	78.8	—	55.6	67.4	—	—	217	217	228	—	96.4	(17.5)	—	33	725
—	555	591	78.4	—	54.7	66.7	73	2055	212	212	222	—	95.5	(16.0)	—	—	705
—	—	579	78.0	—	54.0	66.1	—	2015	207	207	218	—	94.6	(15.2)	—	32	690
—	534	569	77.8	—	53.5	65.8	71	1985	201	201	212	—	93.8	(13.8)	—	31	675
—	—	533	77.1	—	52.5	65.0	—	1915	197	197	207	—	92.8	(12.7)	—	30	655
—	514	547	76.9	—	52.1	64.7	70	1890	192	192	202	—	91.9	(11.5)	—	29	640
(495)	—	539	76.7	—	51.6	64.3	—	1855	187	187	196	—	90.7	(10.0)	—	—	620
—	495	528	76.3	—	51.0	63.8	68	1820	183	183	192	—	90.0	(9.0)	—	28	615
(477)	—	516	75.9	—	50.3	63.2	—	1780	179	179	188	—	89.0	(8.0)	—	27	600
—	—	508	75.6	—	49.6	62.7	—	1740	174	174	182	—	87.8	(6.4)	—	—	585
—	477	508	75.6	—	49.6	62.7	66	1740	170	170	178	—	86.8	(5.4)	—	26	570
(461)	—	495	75.1	—	48.8	61.9	—	1680	167	167	175	—	86.0	(4.4)	—	—	560
—	—	491	74.9	—	48.5	61.7	—	1670	163	163	171	—	85.0	(3.3)	—	25	545
—	461	491	74.9	—	48.5	61.7	65	1670	156	156	163	—	82.9	(0.9)	—	—	525
—	—	474	74.3	—	47.2	61.0	—	1595	149	149	156	—	80.8	—	—	23	505
—	—	472	74.2	—	47.1	60.8	—	1585	143	143	150	—	78.7	—	—	22	490
—	444	472	74.2	—	47.1	60.8	63	1585	137	137	143	—	76.4	—	—	21	460
—	—	474	74.3	—	47.2	61.0	—	1595	131	131	137	—	74.0	—	—	—	450
—	—	472	74.2	—	47.1	60.8	—	1585	126	126	132	—	72.0	—	—	20	435
—	444	472	74.2	—	47.1	60.8	63	1585	121	121	127	—	69.8	—	—	19	415
—	—	472	74.2	—	47.1	60.8	—	1585	116	116	122	—	67.6	—	—	18	400
—	—	472	74.2	—	47.1	60.8	63	1585	111	111	117	—	65.7	—	—	15	385

Note 1) The above list is the same as that of AMS Metals Hand book with tensile strength in approximate metric value and Brinell hardness over a recommended range.

Note 2) 1MPa=1N/mm²

Note 3) Figures in () are rarely used and are included for reference. This list has been taken from JIS Handbook Steel I.

FIT TOLERANCE TABLE (HOLE)

Classification of Standard Dimensions (mm)		Class of Geometrical Tolerance Zone of Holes															
>	≤	B10	C9	C10	D8	D9	D10	E7	E8	E9	F6	F7	F8	G6	G7	H6	H7
—	3	+180	+85	+100	+34	+45	+60	+24	+28	+39	+12	+16	+20	+8	+12	+6	+10
		+140	+60	+60	+20	+20	+20	+14	+14	+14	+6	+6	+6	+2	+2	0	0
3	6	+188	+100	+118	+48	+60	+78	+32	+38	+50	+18	+22	+28	+12	+16	+8	+12
		+140	+70	+70	+30	+30	+30	+20	+20	+20	+10	+10	+10	+4	+4	0	0
6	10	+208	+116	+138	+62	+76	+98	+40	+47	+61	+22	+28	+35	+14	+20	+9	+15
		+150	+80	+80	+40	+40	+40	+25	+25	+25	+13	+13	+13	+5	+5	0	0
10	14	+220	+138	+165	+77	+93	+120	+50	+59	+75	+27	+34	+43	+17	+24	+11	+18
		+150	+95	+95	+50	+50	+50	+32	+32	+32	+16	+16	+16	+6	+6	0	0
14	18	+244	+162	+194	+98	+117	+149	+61	+73	+92	+33	+41	+53	+20	+28	+13	+21
		+160	+110	+110	+65	+65	+65	+40	+40	+40	+20	+20	+20	+7	+7	0	0
18	24	+270	+182	+220	+119	+142	+180	+75	+89	+112	+41	+50	+64	+25	+34	+16	+25
		+170	+120	+120	+80	+80	+80	+50	+50	+50	+25	+25	+25	+9	+9	0	0
30	40	+280	+192	+230	+146	+174	+220	+90	+106	+134	+49	+60	+76	+29	+40	+19	+30
		+180	+130	+130	+100	+100	+100	+60	+60	+60	+30	+30	+30	+10	+10	0	0
40	50	+310	+214	+260	+174	+207	+260	+107	+126	+159	+58	+71	+90	+34	+47	+22	+35
		+190	+140	+140	+120	+120	+120	+72	+72	+72	+36	+36	+36	+12	+12	0	0
50	65	+320	+224	+270	+208	+245	+305	+125	+148	+185	+68	+83	+106	+39	+54	+25	+40
		+200	+150	+150	+145	+145	+145	+85	+85	+85	+43	+43	+43	+14	+14	0	0
65	80	+470	+330	+390	+242	+285	+355	+146	+172	+215	+79	+96	+122	+44	+61	+29	+46
		+310	+230	+230	+170	+170	+170	+100	+100	+100	+50	+50	+50	+15	+15	0	0
80	100	+525	+355	+425	+271	+320	+400	+162	+191	+240	+88	+108	+137	+49	+69	+32	+52
		+340	+240	+240	+190	+190	+190	+110	+110	+110	+56	+56	+56	+17	+17	0	0
100	120	+565	+375	+445	+299	+350	+440	+182	+214	+265	+98	+119	+151	+54	+75	+36	+57
		+380	+260	+260	+210	+210	+210	+125	+125	+125	+62	+62	+62	+18	+18	0	0
120	140	+605	+395	+465	+327	+385	+480	+198	+232	+290	+108	+131	+165	+60	+83	+40	+63
		+420	+280	+280	+230	+230	+230	+135	+135	+135	+68	+68	+68	+20	+20	0	0
140	160	+690	+430	+510	+355	+445	+555	+215	+265	+335	+125	+155	+195	+75	+105	+55	+85
		+480	+300	+300	+240	+240	+240	+160	+160	+160	+80	+80	+80	+30	+30	0	0
160	180	+750	+460	+540	+425	+515	+625	+265	+325	+405	+145	+175	+215	+85	+115	+65	+95
		+540	+330	+330	+280	+280	+280	+190	+190	+190	+95	+95	+95	+40	+40	0	0
180	200	+830	+500	+590	+445	+535	+645	+285	+345	+425	+155	+185	+225	+95	+125	+75	+105
		+600	+360	+360	+300	+300	+300	+210	+210	+210	+125	+125	+125	+55	+55	0	0
200	225	+910	+540	+630	+515	+605	+715	+325	+385	+465	+175	+205	+245	+105	+135	+85	+115
		+680	+400	+400	+340	+340	+340	+240	+240	+240	+145	+145	+145	+65	+65	0	0
225	250	+1010	+595	+690	+645	+735	+845	+385	+455	+535	+205	+235	+275	+115	+145	+95	+125
		+760	+440	+440	+380	+380	+380	+270	+270	+270	+165	+165	+165	+75	+75	0	0
250	280	+750	+460	+540	+695	+785	+895	+425	+495	+575	+235	+265	+305	+125	+155	+105	+135
		+540	+330	+330	+280	+280	+280	+200	+200	+200	+115	+115	+115	+65	+65	0	0
280	315	+830	+500	+590	+715	+805	+915	+465	+535	+615	+255	+285	+325	+135	+165	+115	+145
		+600	+360	+360	+300	+300	+300	+210	+210	+210	+125	+125	+125	+75	+75	0	0
315	355	+910	+540	+630	+845	+935	+1045	+505	+575	+655	+275	+305	+345	+145	+175	+125	+155
		+680	+400	+400	+340	+340	+340	+240	+240	+240	+145	+145	+145	+85	+85	0	0
355	400	+1010	+595	+690	+935	+1025	+1135	+545	+615	+695	+295	+325	+365	+155	+185	+135	+165
		+760	+440	+440	+380	+380	+380	+270	+270	+270	+165	+165	+165	+95	+95	0	0
400	450	+1090	+635	+730	+1045	+1135	+1245	+585	+655	+735	+315	+345	+385	+165	+195	+145	+175
		+840	+480	+480	+420	+420	+420	+300	+300	+300	+185	+185	+185	+105	+105	0	0

Note 1) Values shown in the upper portion of the respective boxes are the upper dimensional tolerance, while values shown in the lower portion are the lower dimensional tolerance.

Class of Geometrical Tolerance Zone of Holes

H8	H9	H10	JS6	JS7	K6	K7	M6	M7	N6	N7	P6	P7	R7	S7	T7	U7	X7
+14 0	+25 0	+40 0	± 3	± 5	0 -6	0 -10	-2 -8	-2 -12	-4 -10	-4 -14	-6 -12	-6 -16	-10 -20	-14 -24	-	-18 -28	-20 -30
+18 0	+30 0	+48 0	± 4	± 6	+2 -6	+3 -9	-1 -9	0 -12	-5 -13	-4 -16	-9 -17	-8 -20	-11 -23	-15 -27	-	-19 -31	-24 -36
+22 0	+36 0	+58 0	± 4.5	± 7	+2 -7	+5 -10	-3 -12	0 -15	-7 -16	-4 -19	-12 -21	-9 -24	-13 -28	-17 -32	-	-22 -37	-28 -43
+27 0	+43 0	+70 0	± 5.5	± 9	+2 -9	+6 -12	-4 -15	0 -18	-9 -20	-5 -23	-15 -26	-11 -29	-16 -34	-21 -39	-	-26 -44	-33 -51 -56
+33 0	+52 0	+84 0	± 6.5	± 10	+2 -11	+6 -15	-4 -17	0 -21	-11 -24	-7 -28	-18 -31	-14 -35	-20 -41	-27 -48	-	-33 -54	-46 -67 -77
+39 0	+62 0	+100 0	± 8	± 12	+3 -13	+7 -18	-4 -20	0 -25	-12 -28	-8 -33	-21 -37	-17 -42	-25 -50	-34 -59	-39 -64 -70	-51 -76 -86	-
+46 0	+74 0	+120 0	± 9.5	± 15	+4 -15	+9 -21	-5 -24	0 -30	-14 -33	-9 -39	-26 -45	-21 -51	-30 -60 -62	-42 -72 -78	-55 -85 -94	-76 -106 -121	-
+54 0	+87 0	+140 0	± 11	± 17	+4 -18	+10 -25	-6 -28	0 -35	-16 -38	-10 -45	-30 -52	-24 -59	-38 -73 -81	-58 -93 -101	-78 -113 -126	-111 -146 -166	-
+63 0	+100 0	+160 0	± 12.5	± 20	+4 -21	+12 -28	-8 -33	0 -40	-20 -45	-12 -52	-36 -61	-28 -68	-48 -88 -90 -93	-77 -117 -125 -133	-107 -147 -159 -171	-	-
+72 0	+115 0	+185 0	± 14.5	± 23	+5 -24	+13 -33	-8 -37	0 -46	-22 -51	-14 -60	-41 -70	-33 -79	-60 -106 -109 -113	-113 -151 -159 -169	-	-	-
+81 0	+130 0	+210 0	± 16	± 26	+5 -27	+16 -36	-9 -41	0 -52	-25 -57	-14 -66	-47 -79	-36 -88	-74 -126 -78 -130	-	-	-	-
+89 0	+140 0	+230 0	± 18	± 28	+7 -29	+17 -40	-10 -46	0 -57	-26 -62	-16 -73	-51 -87	-41 -98	-87 -144 -93 -150	-	-	-	-
+97 0	+155 0	+250 0	± 20	± 31	+8 -32	+18 -45	-10 -50	0 -63	-27 -67	-17 -80	-55 -95	-45 -108	-103 -166 -109 -172	-	-	-	-

FIT TOLERANCE TABLE (SHAFT)

Classification of Standard Dimensions (mm)		Class of Geometrical Tolerance Zone of Shafts														
>	≤	b9	c9	d8	d9	e7	e8	e9	f6	f7	f8	g5	g6	h5	h6	h7
-	3	-140	-60	-20	-20	-14	-14	-14	-6	-6	-6	-2	-2	0	0	0
		-165	-85	-34	-45	-24	-28	-39	-12	-16	-20	-6	-8	-4	-6	-10
3	6	-140	-70	-30	-30	-20	-20	-20	-10	-10	-10	-4	-4	0	0	0
		-170	-100	-48	-60	-32	-38	-50	-18	-22	-28	-9	-12	-5	-8	-12
6	10	-150	-80	-40	-40	-25	-25	-25	-13	-13	-13	-5	-5	0	0	0
		-186	-116	-62	-76	-40	-47	-61	-22	-28	-35	-11	-14	-6	-9	-15
10	14	-150	-95	-50	-50	-32	-32	-32	-16	-16	-16	-6	-6	0	0	0
		-193	-138	-77	-93	-50	-59	-75	-27	-34	-43	-14	-17	-8	-11	-18
14	18	-150	-95	-50	-50	-32	-32	-32	-16	-16	-16	-6	-6	0	0	0
		-193	-138	-77	-93	-50	-59	-75	-27	-34	-43	-14	-17	-8	-11	-18
18	24	-160	-110	-65	-65	-40	-40	-40	-20	-20	-20	-7	-7	0	0	0
		-212	-162	-98	-117	-61	-73	-92	-33	-41	-53	-16	-20	-9	-13	-21
24	30	-160	-110	-65	-65	-40	-40	-40	-20	-20	-20	-7	-7	0	0	0
		-212	-162	-98	-117	-61	-73	-92	-33	-41	-53	-16	-20	-9	-13	-21
30	40	-170	-120	-80	-80	-50	-50	-50	-25	-25	-25	-9	-9	0	0	0
		-232	-182	-119	-142	-75	-89	-112	-41	-50	-64	-20	-25	-11	-16	-25
40	50	-180	-130	-119	-142	-75	-89	-112	-41	-50	-64	-20	-25	-11	-16	-25
		-242	-192	-119	-142	-75	-89	-112	-41	-50	-64	-20	-25	-11	-16	-25
50	65	-190	-140	-100	-100	-60	-60	-60	-30	-30	-30	-10	-10	0	0	0
		-264	-214	-100	-100	-60	-60	-60	-30	-30	-30	-10	-10	0	0	0
65	80	-200	-150	-146	-174	-90	-106	-134	-49	-60	-76	-23	-29	-13	-19	-30
		-274	-224	-146	-174	-90	-106	-134	-49	-60	-76	-23	-29	-13	-19	-30
80	100	-220	-170	-120	-120	-72	-72	-72	-36	-36	-36	-12	-12	0	0	0
		-307	-257	-120	-120	-72	-72	-72	-36	-36	-36	-12	-12	0	0	0
100	120	-240	-180	-174	-207	-107	-126	-159	-58	-71	-90	-27	-34	-15	-22	-35
		-327	-267	-174	-207	-107	-126	-159	-58	-71	-90	-27	-34	-15	-22	-35
120	140	-260	-200	-145	-145	-85	-85	-85	-43	-43	-43	-14	-14	0	0	0
		-360	-300	-145	-145	-85	-85	-85	-43	-43	-43	-14	-14	0	0	0
140	160	-280	-210	-208	-245	-125	-148	-185	-68	-83	-106	-32	-39	-18	-25	-40
		-380	-310	-208	-245	-125	-148	-185	-68	-83	-106	-32	-39	-18	-25	-40
160	180	-310	-230	-208	-245	-125	-148	-185	-68	-83	-106	-32	-39	-18	-25	-40
		-410	-330	-208	-245	-125	-148	-185	-68	-83	-106	-32	-39	-18	-25	-40
180	200	-340	-240	-170	-170	-100	-100	-100	-50	-50	-50	-15	-15	0	0	0
		-455	-355	-170	-170	-100	-100	-100	-50	-50	-50	-15	-15	0	0	0
200	225	-380	-260	-242	-285	-146	-172	-215	-79	-96	-122	-35	-44	-20	-29	-46
		-495	-375	-242	-285	-146	-172	-215	-79	-96	-122	-35	-44	-20	-29	-46
225	250	-420	-280	-242	-285	-146	-172	-215	-79	-96	-122	-35	-44	-20	-29	-46
		-535	-395	-242	-285	-146	-172	-215	-79	-96	-122	-35	-44	-20	-29	-46
250	280	-480	-300	-190	-190	-110	-110	-110	-56	-56	-56	-17	-17	0	0	0
		-610	-430	-190	-190	-110	-110	-110	-56	-56	-56	-17	-17	0	0	0
280	315	-540	-330	-271	-320	-162	-191	-240	-88	-108	-137	-40	-49	-23	-32	-52
		-670	-460	-271	-320	-162	-191	-240	-88	-108	-137	-40	-49	-23	-32	-52
315	355	-600	-360	-210	-210	-125	-125	-125	-62	-62	-62	-18	-18	0	0	0
		-740	-500	-210	-210	-125	-125	-125	-62	-62	-62	-18	-18	0	0	0
355	400	-680	-400	-299	-350	-182	-214	-265	-98	-119	-151	-43	-54	-25	-36	-57
		-820	-540	-299	-350	-182	-214	-265	-98	-119	-151	-43	-54	-25	-36	-57
400	450	-760	-440	-230	-230	-135	-135	-135	-68	-68	-68	-20	-20	0	0	0
		-915	-595	-230	-230	-135	-135	-135	-68	-68	-68	-20	-20	0	0	0
450	500	-840	-480	-327	-385	-198	-232	-290	-108	-131	-165	-47	-60	-27	-40	-63
		-995	-635	-327	-385	-198	-232	-290	-108	-131	-165	-47	-60	-27	-40	-63

Note 1) Values shown in the upper portion of the respective boxes are the upper dimensional tolerance, while values shown in the lower portion are the lower dimensional tolerance.

Class of Geometrical Tolerance Zone of Shafts

h8	h9	js5	js6	js7	k5	k6	m5	m6	n6	p6	r6	s6	t6	u6	x6
0 -14	0 -25	± 2	± 3	± 5	+4 0	+6 0	+6 +2	+8 +2	+10 +4	+12 +6	+16 +10	+20 +14	—	+24 +18	+26 +20
0 -18	0 -30	± 2.5	± 4	± 6	+6 +1	+9 +1	+9 +4	+12 +4	+16 +8	+20 +12	+23 +15	+27 +19	—	+31 +23	+36 +28
0 -22	0 -36	± 3	± 4.5	± 7	+7 +1	+10 +1	+12 +6	+15 +6	+19 +10	+24 +15	+28 +19	+32 +23	—	+37 +28	+43 +34
0 -27	0 -43	± 4	± 5.5	± 9	+9 +1	+12 +1	+15 +7	+18 +7	+23 +12	+29 +18	+34 +23	+39 +28	—	+44 +33	+51 +40 +56 +45
0 -33	0 -52	± 4.5	± 6.5	± 10	+11 +2	+15 +2	+17 +8	+21 +8	+28 +15	+35 +22	+41 +28	+48 +35	—	+54 +41	+67 +54 +77 +64
0 -39	0 -62	± 5.5	± 8	± 12	+13 +2	+18 +2	+20 +9	+25 +9	+33 +17	+42 +26	+50 +34	+59 +43	+64 +48 +70 +54	+76 +60 +86 +70	—
0 -46	0 -74	± 6.5	± 9.5	± 15	+15 +2	+21 +2	+24 +11	+30 +11	+39 +20	+51 +32	+60 +41 +62 +43	+72 +53 +78 +59	+85 +66 +94 +75	+106 +87 +121 +102	—
0 -54	0 -87	± 7.5	± 11	± 17	+18 +3	+25 +3	+28 +13	+35 +13	+45 +23	+59 +37	+73 +51 +76 +54	+93 +71 +101 +79	+113 +91 +126 +104	+146 +124 +166 +144	—
0 -63	0 -100	± 9	± 12.5	± 20	+21 +3	+28 +3	+33 +15	+40 +15	+52 +27	+68 +43	+88 +63 +90 +65 +93 +68	+117 +92 +125 +100 +133 +108	+147 +122 +159 +134 +171 +146	—	—
0 -72	0 -115	± 10	± 14.5	± 23	+24 +4	+33 +4	+37 +17	+46 +17	+60 +31	+79 +50	+106 +77 +109 +80 +113 +84	+151 +122 +159 +130 +169 +140	—	—	—
0 -81	0 -130	± 11.5	± 16	± 26	+27 +4	+36 +4	+43 +20	+52 +20	+66 +34	+88 +56	+126 +94 +130 +98	—	—	—	—
0 -89	0 -140	± 12.5	± 18	± 28	+29 +4	+40 +4	+46 +21	+57 +21	+73 +37	+98 +62	+144 +108 +150 +114	—	—	—	—
0 -97	0 -155	± 13.5	± 20	± 31	+32 +5	+45 +5	+50 +23	+63 +23	+80 +40	+108 +68	+166 +126 +172 +132	—	—	—	—

INTERNATIONAL SYSTEM OF UNITS

UNIT CONVERSION TABLE for EASIER CHANGE into SI UNITS
(Bold type Indicates SI unit)

● **Pressure**

Pa	kPa	MPa	bar	kgf/cm ²	atm	mmH ₂ O	mmHg or Torr
1	1×10 ⁻³	1×10 ⁻⁶	1×10 ⁻⁵	1.01972×10 ⁻⁵	9.86923×10 ⁻⁶	1.01972×10 ⁻¹	7.50062×10 ⁻³
1×10 ³	1	1×10 ⁻³	1×10 ⁻²	1.01972×10 ⁻²	9.86923×10 ⁻³	1.01972×10 ²	7.50062
1×10 ⁶	1×10 ³	1	1×10	1.01972×10	9.86923	1.01972×10 ⁵	7.50062×10 ³
1×10 ⁵	1×10 ²	1×10 ⁻¹	1	1.01972	9.86923×10 ⁻¹	1.01972×10 ⁴	7.50062×10 ²
9.80665×10 ⁴	9.80665×10	9.80665×10 ⁻²	9.80665×10 ⁻¹	1	9.67841×10 ⁻¹	1×10 ⁴	7.35559×10 ²
1.01325×10 ⁵	1.01325×10 ²	1.01325×10 ⁻¹	1.01325	1.03323	1	1.03323×10 ⁴	7.60000×10 ²
9.80665	9.80665×10 ⁻³	9.80665×10 ⁻⁶	9.80665×10 ⁻⁵	1×10 ⁻⁴	9.67841×10 ⁻⁵	1	7.35559×10 ⁻²
1.33322×10 ²	1.33322×10 ⁻¹	1.33322×10 ⁻⁴	1.33322×10 ⁻³	1.35951×10 ⁻³	1.31579×10 ⁻³	1.35951×10	1

Note 1) 1Pa=1N/m²

● **Force**

N	dyn	kgf
1	1×10 ⁵	1.01972×10 ⁻¹
1×10 ⁻⁵	1	1.01972×10 ⁻⁶
9.80665	9.80665×10 ⁵	1

● **Stress**

Pa	MPa or N/mm ²	kgf/mm ²	kgf/cm ²
1	1×10 ⁻⁶	1.01972×10 ⁻⁷	1.01972×10 ⁻⁵
1×10 ⁶	1	1.01972×10 ⁻¹	1.01972×10
9.80665×10 ⁶	9.80665	1	1×10 ²
9.80665×10 ⁴	9.80665×10 ⁻²	1×10 ⁻²	1

Note 1) 1Pa=1N/m²

● **Work / Energy / Quantity of Heat**

J	kW·h	kgf·m	kcal
1	2.77778×10 ⁻⁷	1.01972×10 ⁻¹	2.38889×10 ⁻⁴
3.600 ×10 ⁶	1	3.67098×10 ⁵	8.6000 ×10 ²
9.80665	2.72407×10 ⁻⁶	1	2.34270×10 ⁻³
4.18605×10 ³	1.16279×10 ⁻³	4.26858×10 ²	1

Note 1) 1J=1W·s, 1J=1N·m

1cal=4.18605J

(By the law of weights and measures)

● **Power (Rate of Production / Motive Power) /Heat Flow Rate**

W	kgf·m/s	PS	kcal/h
1	1.01972×10 ⁻¹	1.35962×10 ⁻³	8.6000 ×10 ⁻¹
9.80665	1	1.33333×10 ⁻²	8.43371
7.355 ×10 ²	7.5 ×10	1	6.32529×10 ²
1.16279	1.18572×10 ⁻¹	1.58095×10 ⁻³	1

Note 1) 1W=1J/s, PS:French horse power







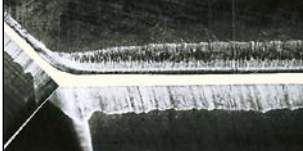
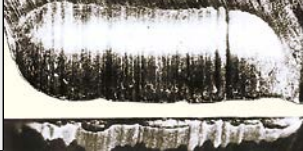

1PS=0.7355kW

1cal=4.18605J

(By the law of weights and measures)

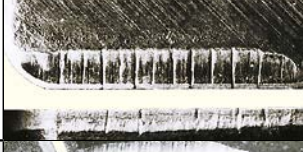
TOOL WEAR AND DAMAGE

CAUSES AND COUNTERMEASURES

Tool Damage Form	Cause	Countermeasure
Flank Wear 	<ul style="list-style-type: none"> • Tool grade is too soft. • Cutting speed is too high. • Flank angle is too small. • Feed rate is extremely low. 	<ul style="list-style-type: none"> • Tool grade with high wear resistance. • Lower cutting speed. • Increase flank angle. • Increase feed rate.
Crater Wear 	<ul style="list-style-type: none"> • Tool grade is too soft. • Cutting speed is too high. • Feed rate is too high. 	<ul style="list-style-type: none"> • Tool grade with high wear resistance. • Lower cutting speed. • Lower feed rate.
Chipping 	<ul style="list-style-type: none"> • Tool grade is too hard. • Feed rate is too high. • Lack of cutting edge strength. • Lack of shank or holder rigidity. 	<ul style="list-style-type: none"> • Tool grade with high toughness. • Lower feed rate. • Increase honing size. (Round honing is to be changed to chamfer honing.) • Use a large tool shank size.
Fracture 	<ul style="list-style-type: none"> • Tool grade is too hard. • Feed rate is too high. • Lack of cutting edge strength. • Lack of shank or holder rigidity. 	<ul style="list-style-type: none"> • Tool grade with high toughness. • Lower feed rate. • Increase honing. (Round honing is to be changed to chamfer honing.) • Use large shank size.
Plastic Deformation 	<ul style="list-style-type: none"> • Tool grade is too soft. • Cutting speed is too high. • Depth of cut and feed rate are too large. • Cutting temperature is high. 	<ul style="list-style-type: none"> • Tool grade with high wear resistance. • Lower cutting speed. • Decrease depth of cut and feed rate. • Tool grade with high thermal conductivity.
Welding 	<ul style="list-style-type: none"> • Cutting speed is low. • Poor sharpness. • Unsuitable grade. 	<ul style="list-style-type: none"> • Increase cutting speed. (For DIN Ck45, cutting speed 80m/min.) • Increase rake angle. • Tool grade with low affinity. (Coated grade, cermet grade)
Thermal Cracks 	<ul style="list-style-type: none"> • Expansion or shrinkage due to cutting heat. • Tool grade is too hard. • *Especially in milling. 	<ul style="list-style-type: none"> • Dry cutting. (For wet cutting, flood workpiece with cutting fluid) • Tool grade with high toughness.
Notching 	<ul style="list-style-type: none"> • Hard surfaces such as uncut surfaces, chilled parts and machining hardened layers. • Friction caused by jagged shape chips. (Caused by small vibration) 	<ul style="list-style-type: none"> • Tool grade with high wear resistance. • Increase rake angle to improve sharpness.
Flaking 	<ul style="list-style-type: none"> • Cutting edge welding and adhesion. • Poor chip disposal. 	<ul style="list-style-type: none"> • Increase rake angle to improve sharpness. • Enlarge chip pocket.
Flank Wear Fracture *Damage for polycrystallines 	<ul style="list-style-type: none"> • Damage due to the lack of strength of a curved cutting edge. 	<ul style="list-style-type: none"> • Increase honing. • Tool grade with high toughness.
Crater Wear Fracture *Damage for polycrystallines 	<ul style="list-style-type: none"> • Tool grade is too soft. • Cutting resistance is too high and causes high cutting heat. 	<ul style="list-style-type: none"> • Decrease honing. • Tool grade with high wear resistance.

CUTTING TOOL MATERIALS

Cemented carbide (WC-Co) was developed in 1923 and was later improved by adding TiC and TaC. In 1969, CVD coating technology was developed and coated carbide has since been widely used. TiC-TiN based cermet was developed in 1974. Today, "Coated carbide grades for roughing and cermet for finishing" is a well established method.

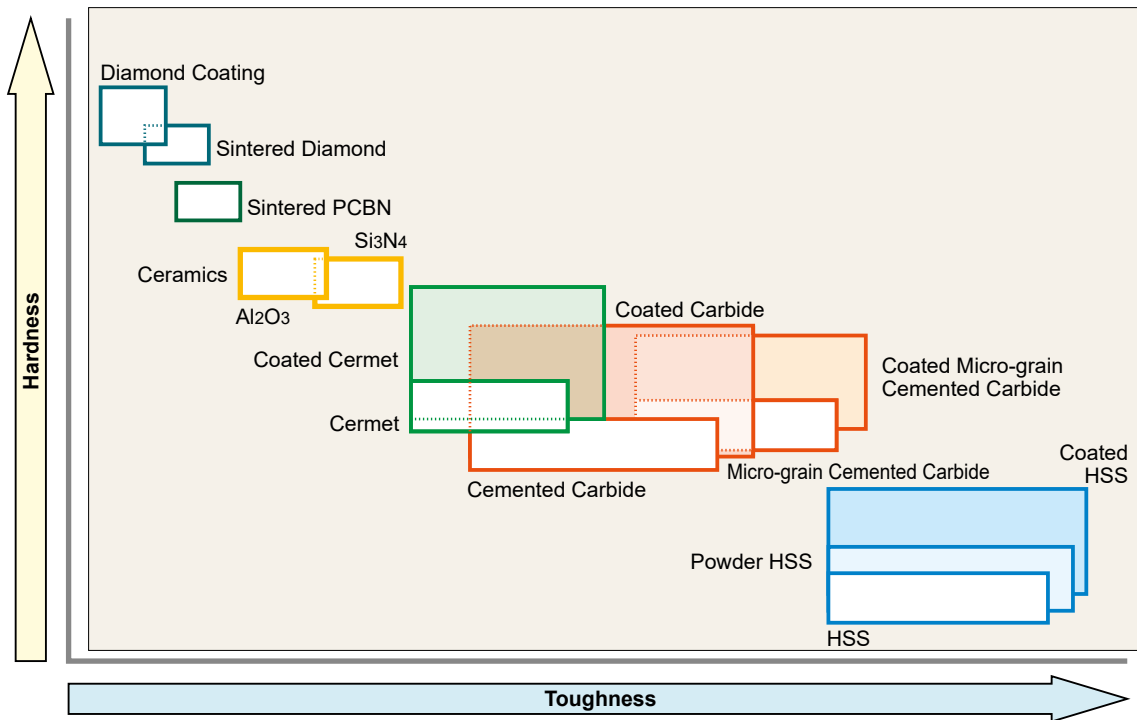

P

GRADE CHARACTERISTICS

Hard Materials	Hardness (HV)	Energy Formation (kcal/g·atom)	Solubility in Iron (%.1250°C)	Thermal Conductivity (W/m·k)	Thermal * Expansion (x 10 ⁻⁶ /k)	Tool Material
Diamond	>9000	–	Highly Soluble	2100	3.1	Sintered Diamond
PCBN	>4500	–	–	1300	4.7	Sintered PCBN
Si ₃ N ₄	1600	–	–	100	3.4	Ceramics
Al ₂ O ₃	2100	-100	≠0	29	7.8	Ceramics Cemented Carbide
TiC	3200	-35	< 0.5	21	7.4	Cermet Coated Carbide
TiN	2500	-50	–	29	9.4	Cermet Coated Carbide
TaC	1800	-40	0.5	21	6.3	Cemented Carbide
WC	2100	-10	7	121	5.2	Cemented Carbide

*1W/m·K=2.39×10⁻³cal/cm·sec·°C

TECHNICAL DATA

GRADE CHAIN

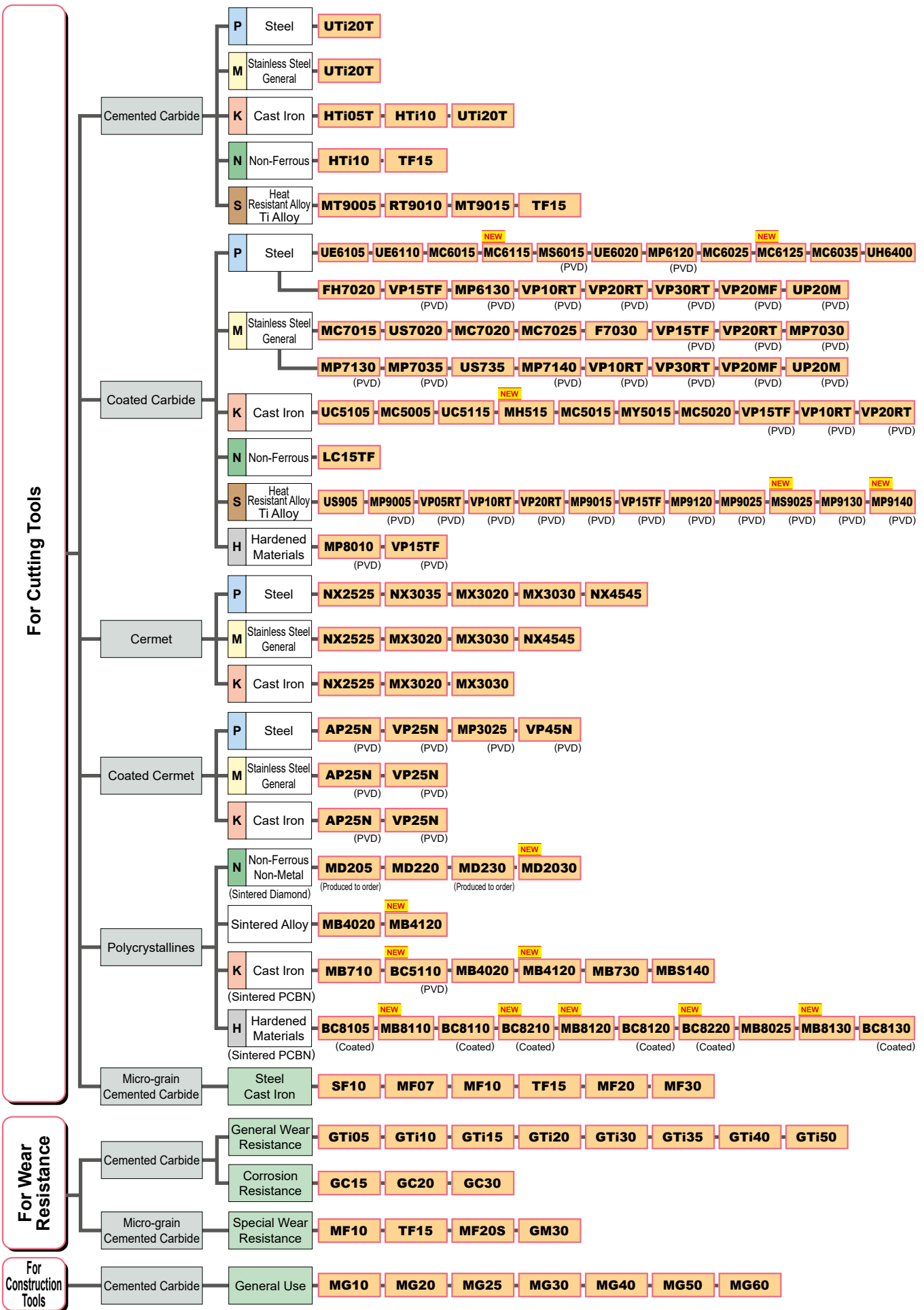

P

TECHNICAL DATA

GRADES COMPARISON TABLE

CEMENTED CARBIDE

Classification	ISO	Mitsubishi Materials	Sandvik	Kennametal	Seco Tools	Iscar	Sumitomo Electric	Tungaloy	Kyocera	Dijet	MOLDINO	
	Symbol											
Turning	P	P01										
		P10				IC70	ST10P	TH10			WS10	
		P20	UTi20T				IC70 IC50M	ST20E	KS20			EX35
		P30	UTi20T				IC50M IC54	A30 A30N	UX30 KS15F			EX35
		P40					IC54	ST40E	TX40			EX35
	M	M10			KU10 K313 K68	890	IC07	EH510	TH10			WA10B
		M20	UTi20T		KU10 K313 K68	HX 883	IC07 IC08 IC20	EH520	KS20			EX35
		M30	UTi20T				IC08 IC20 IC28	A30 A30N	UX30			EX35
		M40					IC28		TU40			
	K	K01	HTi05T		KU10 K313 K68			H1 H2	KS05F			WH01 WH05
		K10	HTi10		KU10 K313 K68	890	IC20	EH510	TH10	KW10 GW15	KT9	WH10
		K20	UTi20T	H13A	KU10 K313 K68	HX	IC20	G10E H10E EH520	KS15F KS20	GW25	KT9	WH20
		K30	UTi20T			883		G10E H10E				
	N	N01		H10				H1 H2	KS05F	GW05 KW10		
		N10	HTi10	H10 HBA	KU10 K313 K68	890	IC08 IC20	EH510	TH10	KW10 GW15	KT9	WH10
		N20		H10 HBA	KU10 K313 K68	HX KX	IC08 IC20	G10E EH520	KS15F		KT9	WH20
		N30				883						
	S	S01	MT9005							SW05		
		S10	MT9005 RT9010 MT9015	H10A H10F H13A	KU10 K313 K68	HX 883	IC07 IC08	EH510	KS05F TH10	SW10		WH13S
		S20	RT9010 TF15		KU10 K313 K68	883	IC07 IC08	EH520	KS15F KS20	SW25		
S30		TF15										
Milling	P	P10										
		P20	UTi20T		K125M		IC50M IC28	A30N			EX35	
		P30	UTi20T	SM30	GX		IC50M IC28	A30N	UX30		EX35	
		P40					IC28				EX35	
	M	M10										
		M20	UTi20T				IC08 IC20	A30N				EX35
		M30	UTi20T	SM30			IC08 IC28	A30N				EX35
		M40					IC28					
	K	K01	HTi05T		K115M,K313							
		K10	HTi10		K115M K313		IC20	G10E	TH10	KW10 GW25	KT9	WH10
		K20	UTi20T	H13A		HX	IC20	G10E		GW25	FZ15	WH20
		K30	UTi20T									

Note 1) The tables above are based on published data and not authorized by each manufacturer.

P

TECHNICAL DATA

MICRO GRAIN

Classification	ISO	Mitsubishi	Sandvik	Kennametal	Seco	Sumitomo	Tungaloy	Kyocera	Dijet	MOLDINO	
	Symbol	Materials			Tools	Electric					
Cutting Tools	Z	Z01	SF10 MF07 MF10	PN90 6UF,H3F 8UF,H6F			F0	F MD05F MD1508		FZ05 FB05 FB10	NM08
		Z10	HTi10 MF20	H10F		890	XF1 F1 AFU	MD10 MD0508 MD07F	FW30	FZ10 FZ15 FB15	NM10 NM12 NM15
		Z20	TF15 MF30	H15F		890 883	AF0 SF2 AF1	EM10 MD20 G1F		FZ15 FB15 FB20	BRM20 EF20N
		Z30				883	A1 CC			FZ20 FB20	NM25 NM40

CERMET

Classification	ISO	Mitsubishi	Sandvik	Kennametal	Seco	Iscar	Sumitomo	Tungaloy	Kyocera	Dijet	MOLDINO	
	Symbol	Materials			Tools		Electric					
Turning	P	P01	AP25N* VP25N*				IC20N IC520N*	T1000A	NS520 GT720*	CCX* TN610 PV710* PV30*		
		P10	NX2525 AP25N* VP25N*	CT5015 GC1525*	KT315 KT125	TP1020 TP1030* CM CMP*	IC20N IC520N* IC530N*	T1500A T1500Z*	NS520 NS9530 GT9530* AT9530*	CCX* TN60 TN610 PV710* TN620 PV720*	CX75	CZ25*
		P20	NX2525 AP25N* VP25N* NX3035 MP3025*	GC1525*	KT325 KT1120 KT5020*	TP1020 TP1030*	IC20N IC520N* IC30N IC530N* IC75T	T1500A T1500Z* T2500A T2500Z* T3000Z*	NS9530 GT9530* AT9530*	TN60 TN620 PV720* TN6020	CX75 PX90*	CH550
		P30	MP3025* VP45N*				IC75T	T3000Z*		PV730* PV90*	PX90*	
	M	M10	NX2525 AP25N* VP25N*	GC1525*	KT125	TP1020 TP1030* CM CMP*		T1000A T1500Z*		TN60 TN620 PV720* TN6020		CZ25*
		M20	NX2525 AP25N* VP25N*					T1500A T1500Z*		TN90 TN6020 TN620 PV720* PV90*		CH550
		M30								PV730*		
	K	K01	NX2525 AP25N*					T1000A	NS520 GT720*	CCX* PV7005*		
		K10	NX2525 AP25N*	CT5015	KT325 KT125				NS520 NS9530 GT9530*	CCX* PV7005* TN60		CZ25*
		K20	NX2525 AP25N*									CH550
	Milling	P	P10	NX2525		C15M	IC30N			TN620M TN60	CX75	MZ1000*
			P20	MX3020 NX2525	CT530	KT530M HT7 KT605M	C15M MP1020	IC30N	T250A T2500A		TN100M TN620M TN60	CX75 CX90
P30			MX3030 NX4545				IC30N	T4500A	NS740		CX90	CH7035
M		M10	NX2525				IC30N			TN60		
		M20	MX3020 NX2525	CT530	KT530M HT7 KT605M	C15M	IC30N	T250A T2500A		TN100M	CX75	
		M30	MX3030 NX4545					T4500A				
K		K01										
		K10	NX2525							TN60	CX75	
		K20	NX2525		KT530M HT7						CX75	

*Coated Cermet

Note 1) The tables above are based on published data and not authorized by each manufacturer.

P

TECHNICAL DATA

GRADES COMPARISON TABLE

CVD COATED GRADE

Classification	ISO	Mitsubishi Materials	Sandvik	Kennametal	Seco Tools	Iscar	Sumitomo Electric	Tungaloy	Kyocera	Dijet	MOLDINO			
	Symbol													
Turning	P	P01	MC6115 UE6105	GC4305 GC4205 GC4415	KCP05B KCP05 KC9105	TP0501 TP0500 TP1501 TP1500	IC9150 IC8150 IC428	AC810P AC700G	T9105 T9025	CA510 CA5505	JC110V	HG8010		
		P10	MC6115 UE6105 MC6015 UE6110 MY5015	GC4315 GC4215 GC4325 GC4415	KCP10B KCP10 KCP25 KC9110	TP1501 TP1500 TP2501 TP2500	IC9150 IC8150 IC8250	AC810P AC700G AC820P AC2000 AC8015P	T9105 T9115 T9215	CA510 CA5505 CA515 CA5515	JC110V JC215V	HG8010 HG8025 GM8020		
		P20	MC6115 MC6015 UE6110 MC6125 MC6025 UE6020 MY5015	GC4315 GC4215 GC4325 GC4425	KCP25B KCP30B KCP25 KC9125	TP2501 TP2500	IC8250 IC9250 IC8350	AC820P AC2000 AC8025P AC830P	T9115 T9125 T9215 T9225	CA025P CA515 CA5515 CA525 CA5525 CR9025	JC110V JC215V	HG8025 GM8020 GM25		
		P30	MC6125 MC6025 UE6020 MC6035 UH6400	GC4325 GC4335 GC4225 GC4235 GC4425	KCP30B KCP30	TP3501 TP3500 TP3000	IC8350 IC9250 IC9350	AC8035P AC830P AC630M	T9125 T9135 T9225 T9235	CA025P CA525 CA5525 CA530 CA5535 CR9025	JC215V JC325V	GM25 GM8035		
		P40	MC6035 UH6400	GC4235 GC4335	KCP40 KCP40B KC9140 KC9240	TP3501 TP3500 TP3000	IC9350	AC8035P AC630M	T9135 T9035 T9235	CA530 CA5535	JC325V	GM8035 GX30		
	M	M10	MC7015 US7020	GC2015 GC2220	KCM15B KCM15	TM1501 TM2000	IC6015 IC8250	AC610M AC6020M	T6120 T9215	CA6515	JX605X JC110V			
		M20	MC7015 US7020 MC7025	GC2015 GC2220	KCM15 KCM25B KCP40B	TM2000 TM2501	IC6015	AC6020M AC610M AC6030M AC630M	T6120 T9215	CA6515 CA6525	JC110V	HG8025 GM25		
		M30	MC7025 US735	GC2025	KCM25 KCM35B KCP40	TM4000 TM3501	IC6025	AC6030M AC630M	T6130	CA6525	JX525X	GM8035 GX30		
		M40	US735	GC2025	KCM35B KCM35	TM4000 TM3501	IC6025	AC6030M AC630M			JX525X	GX30		
	K	K01	MC5005 UC5105	GC3205 GC3210	KCK05B KCK05	TK0501 TH1500	IC5005	AC405K AC410K AC4010K	T505 T515 T5105	CA4505 CA4010 CA310	JC050W JC105V	HX3505		
		K10	MC5015 MH515 UC5115 MY5015	GC3205 GC3210	KCK15B KCK15 KCK20 KC9315 KCK20B	TK0501 TK1501	IC5005 IC5010 IC428	AC405K AC4010K AC410K AC4015K AC415K	T515 T5115	CA315 CA4515 CA4010 CA4115	JC108W JC050W JC105V JC110V	HX3515 HG8010		
		K20	MC5015 MH515 UC5115 UE6110 MY5015	GC3225	KCK20B KCK20 KCPK05	TK1501	IC5010 IC8150	AC4015K AC415K AC420K AC8025P	T5115 T5125	CA320 CA4515 CA4115 CA4120	JC108W JC110V JC215V	HG8025 GM8020		
		K30	UE6110	GC3225	KCPK05			AC8025P	T5125		JC215	HG8025 GM8020		
	S	S01	US905	S05F S205						CA6515 CA6525 CA6535		HS9105 HS9115		
	Milling	P	P10				MP1501	IC5400	ACP2000 XCU2500 ACP100			JC730U		
			P20	F7030 MC7020	GC4220		MP1501 MP2501 T25M	IC5500	ACP2000 ACP3000 XCU2500 ACP100	T3130 T3225		JC730U JC835S	GX2140 GF30	
			P30	F7030 MC7020	GC4330 GC4230	KCPK30 KC930M	MP1501 MP2501 TM25 T350	IC5500	ACP3000 XCU2500 ACP100	T3130 T3225		JC835S JC730U	GX2140 GX2160 GF30	
			P40		GC4340 GC4240	KC935M KC530M	MM4500 T350M						GX2030 GX2160	
		M	M10							XCU2500			JC730U	
			M20	US735 MC7020			KC925M	MP2501 MS2500 T25M T350M		ACP100 ACM200 XCU2500	T3130 T3225	CA6535	JC730U JC835S	AX2040 GX2140
M30			US735 FC7020 MC7020	GC2040		KC930M	MP2501 T25M T350M		ACP100 XCU2500 ACM200	T3130 T3225	CA6535	JC730U JC835S	AX2040 GX2140 GX2160 GX30	
M40						KC930M KC935M	MM4500 T350M						GX2160	
K		K01												
		K10	MC5020						XCK2000 ACK200	T1215 T1115	CA420M	JC605W	GX2120	
		K20	MC5020	GC3220 GC3330 K20W		KC915M	MP1501	IC5100	ACK200 XCK2500 XCK2000 ACK200	T1115		JC610 JC605W JC608X	GX2120	
		K30		GC3330 GC3040		KC920M KC925M KCPK30 KC930M KC935M	MP1501	IC5100 DT7150				JC610		

Note 1) The tables above are based on published data and not authorized by each manufacturer.

PVD COATED GRADE

Classification	ISO	Mitsubishi	Sandvik	Kennametal	Seco	Iscar	Sumitomo	Tungaloy	Kyocera	Dijet	MOLDINO	
	Symbol	Materials			Tools		Electric					
Turning	P	P01							PR1005			
	P10	VP10MF MS6015	GC1125	KCU10 KC5010 KC5510 KU10T	CP200 TS2000	IC250 IC507 IC570 IC807 IC907 IC908		AH710 SH725	PR1005 PR1705 PR930 PR1025 PR1115 PR1225 PR1425 PR1725			
	P20	VP10RT VP20RT VP15TF VP20MF MS6015	GC1125 GC15	KCU10 KC5025 KC5525 KU25T	TS2500	IC1007 IC250 IC308 IC507 IC807 IC808 IC907 IC908 IC1008 IC1028 IC3028		AH710 AH725 AH120 SH730 GH730 GH130 SH725	PR930 PR1025 PR1725 PR1115 PR1225 PR1425 PR1535		IP2000	
	P30	VP10RT VP20RT VP15TF VP20MF	GC1125	KCU25 KC5525 KU25T	CP500	IC228 IC250 IC328 IC330 IC354 IC528 IC1008 IC1028 IC3028		AH725 AH120 SH730 GH730 GH130 AH740 J740 SH725 AH7025	PR1025 PR1725 PR1225 PR1425 PR1535 PR1625		IP3000	
	P40				CP500 CP600	IC228 IC328 IC528 IC928 IC1008 IC1028 IC3028		AH740 J740	PR1535			
	M	M01										
	M10	VP10MF MS6015	GC1115 GC15 GC1105	KCU10 KC5010 KC5510	CP200 TS2000	IC354 IC507 IC520 IC807 IC907 IC1007 IC5080T		AC8005 AH710 SH725	PR1025 PR1225 PR1425 PR1725	JC5003 JC8015	IP050S	
	M20	VP10RT VP20RT VP15TF VP20MF MS9025	GC1115 GC15 GC1125	KCU10 KC5010 KC5510	TS2500 CP500	IC354 IC808 IC908 IC1008 IC1028 IC3028 IC5080T	AC520U AC5015S	AH710 AH725 AH120 SH730 GH730 GH130 GH330 AH630 SH725 AH8015 AH7025	PR1025 PR1125 PR1225 PR1425 PR915 PR930 PR1535 PR1725	JC5003 JC5015 JC8015 JC5118	IP100S	
	M30	VP10RT VP20RT VP15TF VP20MF MP7035	GC1125 GC2035	KCU25 KC5525	CP500 CP600 TTP2050	IC228 IC250 IC328 IC330 IC1008 IC1028 IC9080T	AC520U AC530U AC1030U AC6040M AC5025S	GH330 AH725 AH120 SH730 GH730 GH130 J740 AH645 SH725	PR1125 PR1725 PR1425 PR1535	JC5015 JC8015 JC5118		
	M40	MP7035	GC2035			IC328 IC928 IC1008 IC1028 IC3028 IC9080T	AC530U AC6040M	J740	PR1535	JC5118		
	K	K01										
	K10		GC15	KCU10 KC5010 KC5510	CP200 TS2000	IC350 IC910 IC1008	AC510U	GH110 AH110 AH710				
	K20	VP10RT VP20RT VP15TF		KCU15 KCU25	CP200 TS2000 TS2500	IC228 IC350 IC808 IC830 IC908 IC1007 IC1008		GH110 AH7025 AH110 AH710 AH725 AH120 GH730 GH130				
	K30	VP10RT VP20RT VP15TF		KCU25 KC5525	CP500	IC228 IC350 IC808 IC830 IC908 IC928 IC1007 IC1008		AH725 AH120 GH730 GH130				
	S	S01	MP9005 VP05RT			TH1000	IC507 IC804 IC807 IC907 IC5080T	AC5005S	AH905 AH8005	PR005S PR1305	JC5003 JC8015	JP9105
	S10	MP9005 MP9015 VP10RT	GC1105 GC15	KCU10 KC5010 KC5410 KC5510	CP200 CP250 TS2000 TS2050 TS2500 TH1000	IC507 IC806 IC807 IC903 IC5080T	AC510U AC5015S	AH905 SH730 AH110 AH8005 AH120	PR005S PR015S PR1310	JC5003 JC5015 JC8015	JP9115	
	S20	MP9015 MT9015	GC1125	KCU10 KCU25 KC5025 KC5525	TS2500 CP500	IC228 IC300 IC328 IC808 IC908 IC928 IC3028 IC806 IC9080T	AC510U AC520U AC5025S	AH120 AH725 AH8015	PR015S PR1125 PR1325	JC5015 JC8015 JC5118		
	S30	MS9025 MP9025 VP15TF VP20RT	GC1125	KC5525	CP600	IC928 IC830	AC1030U	AH725 AH7025	PR1125 PR1535	JC5118		
	Milling	P	P01				IC903				JC8003	ATH80D ATH08M TH308 PN208 JP4105 PN15M
		P10		GC1010 GC1130	KC505M KC715M KC510M KC515M		IC250 IC350 IC808 IC810 IC900 IC903 IC908 IC910 IC950	ACU2500 ACP200		PR830 PR1225	JC8003 JC8015 JC5015 JC5118	PN15M PN215 PCA12M JP4115
P20		MP6120 VP15TF	GC1010 GC1030 GC1130 GC2030	KC522M KC525M KC527M KC610M KC620M KC635M KC715M KC720M KC730M KTPK20	F25M MP3000	IC250 IC300 IC328 IC330 IC350 IC808 IC810 IC830 IC900 IC908 IC910 IC928 IC950 IC1008	ACU2500 ACP200	AH3225 AH725 AH120 GH330 AH330 AH9130 AH6030	PR830 PR1225 PR1230 PR1525	JC5015 JC5040 JC6235 JC8015 JC5118 JC6235 JC7560P JC8118P	CY9020 JP4120 CY150	

Note 1) The tables above are based on published data and not authorized by each manufacturer.

P

TECHNICAL DATA

GRADES COMPARISON TABLE

PVD COATED GRADE

Classification	ISO	Mitsubishi Materials	Sandvik	Kennametal	Seco Tools	Iscar	Sumitomo Electric	Tungaloy	Kyocera	Dijet	MOLDINO		
	Symbol												
Milling	P	P30	MP6120 VP15TF MP6130 VP30RT	GC1010 GC1030 GC2030 GC1130	KC735M KC725M KC530M KC537M KCPM40	F25M MP3000 F30M MP2050	IC250 IC300 IC328 IC330 IC350 IC830 IC845 IC900 IC928 IC950 IC1008	ACU2500 ACP200 ACP300	AH725 AH120 AH130 AH140 GH130 AH730 AH3035 AH6030 AH3225 AH9130	PR1230 PR1525	JC6235 JC7560 JC8050 JC7560P JC5015 JC8118 JC5040 JC8118P JC8015 JC5118	JS4045 CY250 CY250V CY25 HC844	
			P40	VP30RT	GC2030 GC1030 GC1130	KC735M KC537M KCPM40	F40M T60M	IC300 IC328 IC330 IC830 IC928 IC1008	ACP300	AH140 AH3035	PR1525	JC6235 JC7560 JC8050 JC7560P JC5040 JC8118 JC5118 JC8118P JC5118	JS4060 PTH30E PTH40H JX1060 JS4060
	M	M01					IC907						PN08M PN208
		M10		GC1025 GC1030 GC1010 GC1130	KC715M KC515M		IC903	ACU2500 ACM100		PR1225			PN15M PN215
		M20	VP15TF MP7130 MP7030 VP20RT	GC1025 GC1030 GC1040 GC2030 S30T	KC610M KC635M KC730M KC720M KC522M KC525M KCPM40 KTPK20	F25M MP3000	IC250 IC300 IC808 IC830 IC900 IC908 IC928 IC1008	ACU2500 ACP200	AH725 AH120 GH330 AH330 GH110 AH6030 AH9130	PR1025 PR1225	JC5015 JC5118 JC8015	JP4120	
		M30	VP15TF MP7130 MP7030 VP20RT MP7140 VP30RT	S30T GC1040 GC2030	KC537M KC725M KC735M KCPM40 KC530M	F30M F40M MP3000 MP2050	IC250 IC300 IC328 IC330 IC380 IC830 IC882 IC928 IC1008	ACP200 ACP300 ACM300	AH120 AH725 AH130 AH140 GH130 AH730 GH340 AH9130 AH3135 AH4035	PR830 PR1225 PR1525 PR1535	JC5015 JC7560 JC8015 JC7560P JC8050 JC8118 JC5118 JC8118P	JS4045 CY250 HC844	
		M40	MP7140 VP30RT			F40M MP2050	IC250 IC300 IC328 IC330 IC882 IC1008	ACP300 ACM300	AH140 AH3135 AH4035	PR1525 PR1535	JC5015 JC7560 JC5118 JC7560P JC8050 JC8118 JC8118P	PTH30E PTH40H JM4160	
	K	K01	MP8010						AH110 GH110 AH330		JC8003		ATH80D ATH08M TH308
		K10	MP8010	GC1010	KC514M KC515M KC527M KC635M	MK2050	IC350 IC810 IC830 IC900 IC910 IC928 IC950 IC380 IC1008	ACU2500 ACK3000	AH110 GH110 AH725 AH120 GH130 AH330	PR1210 PR1510	JC8015		ATH10E TH315 CY100H
		K20	VP15TF VP20RT	GC1010 GC1020	KTPK20 KC514M KC610M KC520M KC620M KC524M	MK2000 MK2050	IC350 IC808 IC810 IC830 IC900 IC908 IC910 IC928 IC950 IC1008	ACU2500 ACK300 ACK3000	GH130 AH9130 AH9030	PR1210 PR1510	JC5015 JC8015 JC6235		CY150 JP4120 CY9020 PTH13S
		K30	VP15TF VP20RT	GC1020	KC522M KC725M KC524M KC735M KC537M	MK2050	IC350 IC808 IC830 IC908 IC928 IC950 IC1008	ACK300 ACK3000				JC6235 JC5015 JC8015 JC8118 JC8118P	
	S	S01					IC907 IC908 IC808 IC903		AH110 AH710	PR1210	JC8003 JC8015 JC5118		PN08M PN208
		S10	MP9120 VP15TF	GC1130 GC1010 GC1030 GC2030	KC510M	MS2050	IC903 IC907 IC908 IC840 IC910 IC808	EH520Z EH20Z ACM100	AH120 AH725	PR1210	JC8003 JC5015 JC8015 JC5118		JS1025 JP4120
		S20	MP9120 VP15TF MP9130 MP9030	S30T GC2030 GC1030 GC1130	KC522M KC525M KCSM30 KCPM40	MS2050 MP2050	IC300 IC908 IC808 IC900 IC830 IC928 IC328 IC330 IC840 IC882 IC380	EH520Z EH20Z ACK300 ACP300	AH725 AH6030 AH130	PR1535	JC8015 JC5015 JC8050 JC5118		PTH30H
		S30		GC2030 GC1040	KC725M KCPM40	MS2050 F40M KCSM40	IC830 IC882 IC928	ACP300 ACM300	AH3135	PR1535	JC8050 JC7560 JC5118		JM4160
		H	H01	MP8010 VP05HT				IC903				JC8003 DH103 JC8008 DH102	
H10	VP15TF VP10H	GC1130 GC1010 GC1030	KC505M KC510M	MH1000 F15M	IC900 IC808 IC907 IC905					JC8003 JC8008 JC8015 JC5118 JC8118P		JP4105 TH303 TH308 PTH08M ATH08M ATH80D	
H20	VP15TF	GC1030 GC1130			F15M	IC900 IC808 IC908 IC380 IC1008		AH3135		JC8015 JC5118 JC8118P		JP4115 TH315	
H30					MP3000 F30M	IC380 IC900 IC1008		AH3135				JP4120	

Note 1) The tables above are based on published data and not authorized by each manufacturer.

PCBN

Classification	ISO	Mitsubishi Materials	Sandvik	Seco Tools	Sumitomo Electric	Tungaloy	Kyocera	Dijet	
	Symbol								
Turning	H	H01	BC8105 BC8110 MB8110	CB7105	CBN060K	BNC100 BNX10 BN1000 BNC2010	BXM10 BX310	KBN05M KBN10M KBN510	
		H10	BC8110 MBC020 BC8120 BC8220 MB8025 MB8110 MB8120	CB7115 CB7015	CBN010	BNC160 BNX20 BN2000 BNC2020	BXM10 BX330 BX530	KBN05M KBN25M KBN525	JBN300
		H20	MBC020 BC8120 BC8220 MB8025 MB8120	CB7125 CB7025 CB20	CBN150 CBN160C	BNC200 BNX25 BN250 BNC2020	BXM20 BXA20 BX360	KBN525 KBN05M KBN25M	JBN245
		H30	BC8130 MB8130	CB7135 CB7525	CBN150 CBN160C	BNC300 BN350	BXC50 BX380	KBN35M	
	S	S01	MB730 MB8025		CBN170	BN700 BN7000	M714B		
		S10				BNS8125	BX470, BX480		
		S20							
		S30							
	K	K01	MB710 BC5110 MB5015			BN500 BNC500	BX870 BX930 BX910		
		K10	MB730 MB4020 MB4120	CB7525		BN700 BN7500 BN7000	BX470 BX480	KBN60M	JBN795
		K20	MB730 MB4020 MB4120		CBN200	BN700 BN7000	BX480	KBN60M	JBN500
		K30	BC5030	CB7925	CBN300 CBN400C CBN500	BNS800 BNC8115, BNC8125	BX90S BXC90	KBN900	
	Sintered Alloy		MB4020 MB4120		CBN200	BN7500 BN7000 BNC7115	BX470 BX480	KBN570 KBN70M	

PCD

Classification	ISO	Mitsubishi Materials	Sandvik	Seco Tools	Sumitomo Electric	Tungaloy	Kyocera	Dijet
	Symbol							
Turning	N	N01	MD205	CD05	PCD05	DA90	DX180 DX160	KPD001 JDA30 JDA735
		N10	MD220	CD10	PCD10	DA150	DX140	KPD010
		N20	MD220		PCD20	DA2200	DX120	JDA715
		N30	MD230 MD2030		PCD30 PCD30M	DA1000	DX110	KPD230 JDA10

Note 1) The tables above are based on published data and not authorized by each manufacturer.

TECHNICAL DATA

INSERT CHIPBREAKER COMPARISON TABLE

NEGATIVE INSERT TYPE

ISO Classification	Cutting Mode	Mitsubishi Materials	Sandvik	Kennametal	Seco Tools	Sumitomo Electric	Tungaloy	Kyocera	Dijet	MOLDINO	Walter	TaeguTec
P	Finish	FH, FP FY, FS	LC	FF	FF1, FF2	FA, FB FL	01* TF, 11 ZF	GP, PP, VF XP, XP-T, XF		FE	FP5	FA FX
	Light	LP SA, SH	XF PF MF	K LF, FN	MF2	SU LU, FE SX, SE	PS NS, 27 TSF, AS, TQ	PQ HQ, CQ	PF UR, UA, UT	BE B, BH, CE	MP3, FV5	FM FG
	Light (Mild Steel)	SY					17	XQ, XS				FC
	Light (With Wiper)	SW	WL, WF	FW	W-FF2 W-MF2	LUW, SEW	FW, SW AFW, ASW	WF WP, WQ			FW5, NF	WS
	Medium	MP MA MH	PM QM, XM XMR	MP, P MN	MF3 MF5, M3 M5	GU UG GE, UX	PM, NM, ZM TA, TM, AM, 28 DM, 33, 37, 38	PG, CJ, GS PS, HS PT	PG UB	CT, AB AH, AR AY, AE	MP5, MV5 MU5	PC, MP, FT MT
	Medium (With Wiper)	MW	WMX, WM WR	MW, RW	W-M6, W-M3 W-MF5	GUW		WE			MW5, NM	WT
	Rough	RP GH Std.	PR, HM Std.	RN, RP	M6, MR6, MR7	MU, MX, ME UZ	TH, THS Std.	PH GT Std.	UD GG	RE Y	RP5, RP7 RV5	RT Std.
	Heavy	HZ HL, HM, HX HV	QR, PR HR, MR	MR, RP RM RH	R4, R5 R57, RR6, R7 R68, RR9	MP HG, HP HU, HW, HF	TRS, 57 TU TUS, 65	PX	UC	HX HE, H	NRF HU5 NRR	RX, RH HD, HY, HT HZ, EH
M	Finish Light	SH, LM	XF, MF	FF, FP LF*	FF1, FF2 MF1	SU, EF	SS	MQ, SK*		MP, AB, BH	FM5	SF
	Medium	MS, GM MM, MA ES	MM QM, XM K	MS, MP UP	MF3 MF4 MF5, M3	EX, EG, UP GU HM	SA, SF SM S	MS, MU TK ST	SF, SZ SG	PV, DE, SE AH	MM5, RM5 MU5	ML EM, MM VF
	Heavy	GH, RM HL, HZ	MR MR	MR, RP	M5, M6, R6 R56, RR6, R7 R8, PR9	EM, MU MP	TH, SH		AE		HU5	
K	Finish Light	LK, MA	KF	FN	MF2 M3, M4		CF	KQ		VA, AH	MK5	FG
	Medium	MK, GK Std.	KM	RP, UN	M5	UZ, GZ, UX	CM Std.	KG, Std., C	PG	V, AE	RK5, MV7	MC
	Rough	RK	KR, KRR		MR7			KH, GC, PH	GG	RE	RK7 RV7	KT
	Heavy	Flat top		Flat top	MR9 Flat top	Flat top	CH, Flat top	ZS, Flat top	Flat top	Flat top	Flat top	
S	Finish	FJ*	SF	FS*, FF	MF1	EF		MQ, SK*			FM5	FA
	Light	LS, MJ, MJ*	SGF*	LF*, MS, FN	MF3	SU*	HRF				NFT MS3	EA, SF
	Medium	MS MA	NGP*, SM QM	UP, P, NGP*	M1 M3	EG, EX, UP	HRM, 28 SA, HMM	SQ MS, MU, TK		VI	NMS, NMT MU5	
	Heavy	RS, GJ	SR, SMR	RP	MR3 MR4	MU		SG, SX			NRS, NRT HU5	ET

*Peripheral ground type insert.

Note 1) The tables above are based on published data and not authorized by each manufacturer.

7° POSITIVE INSERT TYPE

ISO Classification	Cutting Mode	Mitsubishi Materials	Sandvik	Kennametal	Seco Tools	Sumitomo Electric	Tungaloy	Kyocera	Dijet	MOLDINO	Walter	TaeguTec
P	Finish	SMG*	UM*	LF*		FC*, SC*	JS*, 01*	CF*, CK* GQ*, GF* SKS*, SK*			FP2*	SA*
	Finish Light	FP, FV LP, SV	PF, UF	UF, 11 LF, FP	FF1 F1, MF2	FB, FP, LU LB, SU	PF, PSF PS, PSS, TSF	GP, PP, VF XP		JQ	PF4, FP4	FA, FX FG
	Light (With Wiper)	SW	WF	FW	W-F1	LUW, SDW		WP			PF	
	Medium	MV MP, Std.	PM, UM PR, UR	MF, MP	M3 F2, M5	GU MU	TM, 23 PM, 24	HQ, MF* XQ, GK	FT	JE	FP6, MP4 RP4	PC MT
	Medium (With Wiper)	MW	WM	MW	W-MF2 W-M3		SW				PM	WT
M	Finish Light	FM LM	MF, UF	LF, UF FP	F1, F2 MF2	FC*, SI* LU LB, SU	PF, PSF PS, PSS	CF*, CK* GQ*, GF* MQ*, SK*		MP	FM2* FM4	FA FG
	Medium	MM, Std.	MM, UM MR, UR	MP	M3 M5	GU, MU	PM	HQ, GK			FM6 MM4, RM4	PC MT
K	Medium	MK, Std. Flat top	KF, KM, UM, KR	Flat top	F1, M3, M5	MU, Flat top*	Flat top, CM	Flat top*			FK6, MK4 RK4, RK6	MT
N	Medium	AZ*	AL*	HP*	AL*	AG* AW*	AL*	AP* AH*	ASF*, ALU* ACB*		FN2*, PM2* MN2*	FL*
S	Finish Light	FS*, LS* FS-P*, LS-P* FJ* LS, MS	UM* UF, MF UM, MM	LF* HP*		SI* GU	Std.	CF*, CK* GQ*, GF* SK*, MQ			FM2* FM4, FM6 MM4, RM4	SA*, FA, FG PC, MT

*Peripheral ground type insert.

Note 1) The tables above are based on published data and not authorized by each manufacturer.

11° POSITIVE INSERT TYPE

ISO Classification	Cutting Mode	Mitsubishi Materials	Sandvik	Kennametal	Seco Tools	Sumitomo Electric	Tungaloy	Kyocera	Dijet	MOLDINO	Walter	TaeguTec
P	Finish Light	FV, SMG* SV	PF	UF, FP FW, LF		SI, FK, FB LU, LUW, LB SU, SF	01* PF, PSF PS, PSS, TSF	PP, GP, GF* SKS*CF*CK* PF*, XP		JQ	FP4	FG PC
	Medium	MV	PM, UM	MF MP, MW		GU, MU, US	PM TM, 23 24	HQ XQ	BM	JE	MP4	
M	Finish Light	SMG* SV	MF	HP* LF		SU	SS* PF, PS	GF*, CK* PF*, GP, CF* SKS*		MP	FM4	PC
	Medium	MV	MM			GU, MU, US	PM, Std.	HQ			MM4	

*Peripheral ground type insert.

Note 1) The tables above are based on published data and not authorized by each manufacturer.

P

TECHNICAL DATA

Memo

A series of horizontal dashed lines for writing, spanning the width of the page.

INDEX

INDEX FOR TOOL NUMBER

A.....	2
B.....	2
C.....	2
D.....	3
E.....	4
F.....	4
G.....	5
H.....	5
J.....	6
K.....	6
L.....	6
M.....	6
N.....	7
P.....	7
R.....	7
S.....	8
T.....	9
U.....	10
V.....	10
W.....	10
X.....	11

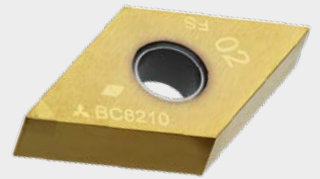
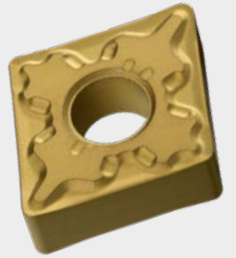

INDEX FOR TOOL NUMBER

Order Number	PRODUCT NAME	Page	Order Number	PRODUCT NAME	Page
A			CBS	Breaker piece	N017
A			CBS	Breaker piece	N017
A DCLNR/L12	DOUBLE CLAMP DIMPLE BAR.....	E015	CBT	Breaker piece	N017
A DDUNR/L15	DOUBLE CLAMP DIMPLE BAR.....	E015	CBT	Breaker piece	N017
A DSKNR/L12	DOUBLE CLAMP DIMPLE BAR.....	E016	CBT	Breaker piece	N017
A DTFNR/L16	DOUBLE CLAMP DIMPLE BAR.....	E016	CCET R/L-SN	Insert (Class E tolerance).....	A145
A DVUNR/L16	DOUBLE CLAMP DIMPLE BAR.....	E017	CCET R/L-SR	Insert (Class E tolerance).....	A143, A144
A DWLNRL/L	DOUBLE CLAMP DIMPLE BAR.....	E017	CCET R/LW-SN	Insert (Class E tolerance).....	A145
AJS T	Clamp screw.....	N003	CCGH MR/L-F	Insert (Class G tolerance).....	A141
AMS	Clamp bridge.....	N015	CCGH R/L-F	Insert (Class G tolerance).....	A140
A PCLNR/L	P type boring bar.....	E038	CCGT AZ	Insert (Class G tolerance).....	A140
A PDQNR/L15	P type boring bar.....	E039	CCGT FJ	Insert (Class G tolerance).....	A139
A PDUNR/L	P type boring bar.....	E038	CCGT L-F	Insert (Class G tolerance).....	A140
A PDZNR/L15	P type boring bar.....	E040	CCGT LS	Insert (Class G tolerance).....	A141
A PSKNR/L	P type boring bar.....	E037	CCGT M-FS	Insert (Class G tolerance).....	A139
A PTFNR/L	P type boring bar.....	E037	CCGT M-FS-P	Insert (Class G tolerance).....	A139
A PWLNRL/L06	P type boring bar.....	E039	CCGT M-LS	Insert (Class G tolerance).....	A141
ASS	Spring (For AJX/BRE/CV type cutter).....	C032	CCGT M-LS-P	Insert (Class G tolerance).....	A141
B			CCGT MR/L-F	Insert (Class G tolerance).....	A141
BCP	Shim pin.....	N014	CCGT MR/L-SN	Insert (Class G tolerance).....	A144
BF-CCGT 2	Insert (Class G tolerance).....	B052	CCGT MR/L-SS	Insert (Class G tolerance).....	A142
BF-CNGM WS2	Insert (Class G tolerance).....	B038	CCGT R/L-SS	Insert (Class G tolerance).....	A142
BF-CNGM 2	Insert (Class G tolerance).....	B038	CCGT SMG	Insert (Class G tolerance).....	A145
BF-DCGT 2	Insert (Class G tolerance).....	B055	CCGW	Insert (Class G tolerance).....	A145
BF-DNGM 2	Insert (Class G tolerance).....	B042	CCK	Clamp bridge.....	N015
BF-DNGM WS2	Insert (Class G tolerance).....	B042	CCMH MV	Insert (Class M tolerance).....	A143
BM-CCGT 2	Insert (Class G tolerance).....	B052	CCMH SV	Insert (Class M tolerance).....	A141
BM-CNGM 2	Insert (Class G tolerance).....	B038	CCMT	Insert (Class M tolerance).....	A143
BM-DCGT 2	Insert (Class G tolerance).....	B055	CCMT FM	Insert (Class M tolerance).....	A139
BM-DNGM 2	Insert (Class G tolerance).....	B042	CCMT FP	Insert (Class M tolerance).....	A139
BM-TNGM 3	Insert (Class G tolerance).....	B045	CCMT FV	Insert (Class M tolerance).....	A139
BOES101	Set bolt.....	N009	CCMT LM	Insert (Class M tolerance).....	A141
BPT322	Shim.....	N011	CCMT LP	Insert (Class M tolerance).....	A141
BRS	Clamp screw.....	N003	CCMT LS	Insert (Class M tolerance).....	A141
BTAHR/L 50	Small tools holder (External back turning).....	D014	CCMT MK	Insert (Class M tolerance).....	A143
BTAT R/L-B	Insert for external back turning.....	D014	CCMT MM	Insert (Class M tolerance).....	A142
BTAT605000RX	Insert for external back turning.....	D014	CCMT MP	Insert (Class M tolerance).....	A142
BTBT R/L-B	Insert for external back turning.....	D015	CCMT MS	Insert (Class M tolerance).....	A143
BTBT606000R/L	Insert for external back turning.....	D015	CCMT MW	Insert (Class M tolerance).....	A143
BTVHR 75	Small tools holder (External back turning).....	D016	CCMT SW	Insert (Class M tolerance).....	A141
BTVT R-B	Insert for external back turning.....	D016	CCMW	Insert (Class M tolerance).....	A145, B068
C			CCP	Shim pin.....	N014
CA	Clamp bridge.....	N015	CCTC1	Clamp bridge.....	N015
CAS51T	Set screw.....	N003	C FR-BLS	MICRO-MINI boring bar (Solid carbide).....	E024, F126
CB RS	MICRO-MINI TWIN.....	E021	CG RS	MICRO-MINI TWIN.....	F127
CB RS	MICRO-MINI TWIN.....	E021	CG RS	MICRO-MINI TWIN.....	F127
CB RS-B	MICRO-MINI TWIN.....	E021	C GYHER/LM00-M25R/L	GY PSC holder.....	F090
CB RS B	MICRO-MINI TWIN.....	E021	C GYHER/LM50-M25R/L	GY PSC holder.....	F094

Order Number	PRODUCT NAME	Page	Order Number	PRODUCT NAME	Page
C ⁰ GYHER/LM90-M25R/L	GY PSC holder	F092	CPMH ⁰⁰⁰⁰⁰⁰⁰⁰ R/L-F	Insert (Class M tolerance)	A146
C ⁰⁰ HR-BLS	MICRO-MINI boring bar (Solid carbide)	E024, F126	CPMH ⁰⁰⁰⁰⁰⁰⁰⁰ SV	Insert (Class M tolerance)	A146
CK ⁰⁰⁰⁰	Clamp bridge	N015	CPMX ⁰⁰⁰⁰⁰⁰⁰⁰	Insert (Class M tolerance)	A146
CKW6	Clamp bridge	N016	CPT ⁰⁰⁰	Side lock plate	C016–C018, C023
CNGA ⁰⁰⁰⁰⁰⁰⁰⁰	Insert (Class G tolerance)	B038	CR ⁰	Stop ring	G012, G013, H016
CNGG ⁰⁰⁰⁰⁰⁰⁰⁰ FJ	Insert (Class G tolerance)	A098	CR ⁰⁰⁰ RS ⁰⁰	MICRO-MINI TWIN	E022
CNGG ⁰⁰⁰⁰⁰⁰⁰⁰ MJ	Insert (Class G tolerance)	A099	CR ⁰⁰⁰ RS ⁰⁰⁰ B	MICRO-MINI TWIN	E022
CNGN ⁰⁰⁰⁰⁰⁰⁰⁰	Insert (Class G tolerance)	B049	CS ⁰⁰⁰	Shim	N011
CNMA ⁰⁰⁰⁰⁰⁰⁰⁰	Insert (Class M tolerance)	A104, B064	CS1/8 ⁰⁰⁰⁰⁰⁰⁰⁰	Coolant hose kit	F121
CNMG ⁰⁰⁰⁰⁰⁰⁰⁰	Insert (Class M tolerance)	A102	C ⁰⁰⁰⁰ SCLCR ⁰⁰⁰	MICRO-DEX boring bar, S type boring bar (Carbide shank)	E018, E032
CNMG ⁰⁰⁰⁰⁰⁰⁰⁰ FH	Insert (Class M tolerance)	A098	C ⁰⁰⁰⁰ SDQCR ⁰⁰⁰	S type boring bar (Carbide shank)	E033
CNMG ⁰⁰⁰⁰⁰⁰⁰⁰ FP	Insert (Class M tolerance)	A098	C ⁰⁰⁰⁰ SDUCR ⁰⁰⁰	S type boring bar (Carbide shank)	E031
CNMG ⁰⁰⁰⁰⁰⁰⁰⁰ FS	Insert (Class M tolerance)	A098	CSF401260T	Clamp screw	N003
CNMG ⁰⁰⁰⁰⁰⁰⁰⁰ FY	Insert (Class M tolerance)	A098	CS ⁰⁰⁰⁰ T	Clamp screw	N003
CNMG ⁰⁰⁰⁰⁰⁰⁰⁰ GH	Insert (Class M tolerance)	A103	CS ⁰⁰⁰⁰⁰⁰⁰⁰ T	Clamp screw	N003
CNMG ⁰⁰⁰⁰⁰⁰⁰⁰ GJ	Insert (Class M tolerance)	A103	CS ⁰⁰⁰⁰⁰⁰⁰⁰ T	Clamp screw	N003
CNMG ⁰⁰⁰⁰⁰⁰⁰⁰ GK	Insert (Class M tolerance)	A101	C ⁰⁰⁰⁰ STFCR ⁰⁰⁰	S type boring bar (Carbide shank)	E030
CNMG ⁰⁰⁰⁰⁰⁰⁰⁰ GM	Insert (Class M tolerance)	A101	CS ⁰⁰⁰⁰⁰⁰⁰⁰ TS	Clamp screw	N003
CNMG ⁰⁰⁰⁰⁰⁰⁰⁰ LK	Insert (Class M tolerance)	A099	C ⁰⁰⁰⁰ STUCR06	MICRO-DEX boring bar (Carbide shank)	E019
CNMG ⁰⁰⁰⁰⁰⁰⁰⁰ LM	Insert (Class M tolerance)	A098	CSVHR/L ⁰⁰⁰⁰⁰	Small tools holder (For cam tool posts)	D027
CNMG ⁰⁰⁰⁰⁰⁰⁰⁰ LP	Insert (Class M tolerance)	A098	C ⁰⁰⁰⁰ SVQCR ⁰⁰⁰	S type boring bar (Carbide shank)	E034
CNMG ⁰⁰⁰⁰⁰⁰⁰⁰ LS	Insert (Class M tolerance)	A099	CSVTB ⁰⁰⁰⁰⁰ R-B	Insert for external back turning	D028
CNMG ⁰⁰⁰⁰⁰⁰⁰⁰ MA	Insert (Class M tolerance)	A101	CSVTB ⁰⁰⁰⁰⁰ R/L	Insert for external back turning	D028
CNMG ⁰⁰⁰⁰⁰⁰⁰⁰ MH	Insert (Class M tolerance)	A101	CSVTBXL	Insert for external back turning, Copying	D028
CNMG ⁰⁰⁰⁰⁰⁰⁰⁰ MJ	Insert (Class M tolerance)	A099	CSVTC ⁰⁰⁰⁰⁰ R-B	Insert for external cutting off	D028
CNMG ⁰⁰⁰⁰⁰⁰⁰⁰ MK	Insert (Class M tolerance)	A100	CSVTC ⁰⁰⁰⁰⁰ R/L	Insert for external cutting off	D028
CNMG ⁰⁰⁰⁰⁰⁰⁰⁰ MM	Insert (Class M tolerance)	A100	CSVTF ⁰⁰⁰⁰⁰ R/L	Insert for external front turning	D027
CNMG ⁰⁰⁰⁰⁰⁰⁰⁰ MP	Insert (Class M tolerance)	A100	CSVTF ⁰⁰⁰⁰⁰ R/L-B	Insert for external front turning	D027
CNMG ⁰⁰⁰⁰⁰⁰⁰⁰ MS	Insert (Class M tolerance)	A100, A101	CSVTFXL	Insert for external front turning, Copying	D027
CNMG ⁰⁰⁰⁰⁰⁰⁰⁰ MW	Insert (Class M tolerance)	A102	CSVTG ⁰⁰⁰⁰⁰ R/L	Insert for grooving	D029
CNMG ⁰⁰⁰⁰⁰⁰⁰⁰ RK	Insert (Class M tolerance)	A103	CSVTT60050RR/L	Insert for threading	D029
CNMG ⁰⁰⁰⁰⁰⁰⁰⁰ RM	Insert (Class M tolerance)	A102	C ⁰⁰⁰⁰ SWUBR ⁰⁰⁰	MICRO-DEX boring bar (Carbide shank)	E018
CNMG ⁰⁰⁰⁰⁰⁰⁰⁰ RP	Insert (Class M tolerance)	A102	CT ⁰⁰⁰	Shim	N011
CNMG ⁰⁰⁰⁰⁰⁰⁰⁰ RS	Insert (Class M tolerance)	A103	CTAHR/L ⁰⁰⁰⁰⁰ -120	Small tools holder (External cutting off)	D020
CNMG ⁰⁰⁰⁰⁰⁰⁰⁰ SA	Insert (Class M tolerance)	A099	CTAHR1010-120S	Small tools holder (External cutting off)	D020
CNMG ⁰⁰⁰⁰⁰⁰⁰⁰ SH	Insert (Class M tolerance)	A099	CTAT ⁰⁰⁰⁰⁰⁰⁰⁰⁰⁰⁰⁰ B	Insert for cutting off	D021
CNMG ⁰⁰⁰⁰⁰⁰⁰⁰ SW	Insert (Class M tolerance)	A099	CTAT ⁰⁰⁰⁰⁰⁰⁰⁰⁰⁰⁰⁰ BX	Insert for cutting off	D021
CNMG ⁰⁰⁰⁰⁰⁰⁰⁰ SY	Insert (Class M tolerance)	A099	CTAT ⁰⁰⁰⁰⁰⁰⁰⁰⁰⁰⁰⁰ LL/RR	Insert for cutting off	D021
CNMM ⁰⁰⁰⁰⁰⁰⁰⁰ HL	Insert (Class M tolerance)	A103	CTBHR/L ⁰⁰⁰⁰⁰ -160	Small tools holder (External back turning, External cutting off)	D015, D022
CNMM ⁰⁰⁰⁰⁰⁰⁰⁰ HM	Insert (Class M tolerance)	A104	CTBT ⁰⁰⁰⁰⁰⁰⁰⁰⁰⁰⁰⁰ B	Insert for cutting off	D022
CNMM ⁰⁰⁰⁰⁰⁰⁰⁰ HR	Insert (Class M tolerance)	A104	CTE ⁰⁰⁰ TN/P ⁰⁰⁰	Shim (For MMTE holder)	G019
CNMM ⁰⁰⁰⁰⁰⁰⁰⁰ HV	Insert (Class M tolerance)	A104	CTI ⁰⁰⁰ TN/P ⁰⁰⁰	Shim (For MMTI holder)	G026
CNMM ⁰⁰⁰⁰⁰⁰⁰⁰ HX	Insert (Class M tolerance)	A103	CT ⁰⁰⁰ RS-M ⁰⁰⁰	MICRO-MINI TWIN	G031
CNMM ⁰⁰⁰⁰⁰⁰⁰⁰ HZ	Insert (Class M tolerance)	A104	CT32T1	Shim	N012
CNMN ⁰⁰⁰⁰⁰⁰⁰⁰	Insert (Class M tolerance)	A136	D		
CPGT ⁰⁰⁰⁰⁰⁰⁰⁰	Insert (Class G tolerance)	A146, B067	DCET ⁰⁰⁰⁰⁰⁰⁰⁰ R/L-SN	Insert (Class E tolerance)	A151, A152
CPGT ⁰⁰⁰⁰⁰⁰⁰⁰ R/L-F	Insert (Class G tolerance)	A146	DCET ⁰⁰⁰⁰⁰⁰⁰⁰ R/L-SR	Insert (Class E tolerance)	A150, A151
CPMH ⁰⁰⁰⁰⁰⁰⁰⁰ FV	Insert (Class M tolerance)	A146			
CPMH ⁰⁰⁰⁰⁰⁰⁰⁰ MV	Insert (Class M tolerance)	A146			

INDEX FOR TOOL NUMBER

Order Number	PRODUCT NAME	Page	Order Number	PRODUCT NAME	Page
DCET	Insert (Class E tolerance)	A152	DNMG	Insert (Class M tolerance)	A105
DCGT	Insert (Class G tolerance)	A147	DNMG	Insert (Class M tolerance)	A110
DCGT	Insert (Class G tolerance)	A147	DNMG	Insert (Class M tolerance)	A110
DCGT	Insert (Class G tolerance)	A147	DNMG	Insert (Class M tolerance)	A108
DCGT	Insert (Class G tolerance)	A148	DNMG	Insert (Class M tolerance)	A108
DCGT	Insert (Class G tolerance)	A149	DNMG	Insert (Class M tolerance)	A106
DCGT	Insert (Class G tolerance)	A151	DNMG	Insert (Class M tolerance)	A106
DCGT	Insert (Class G tolerance)	A149	DNMG	Insert (Class M tolerance)	A106
DCGT	Insert (Class G tolerance)	A141	DNMG	Insert (Class M tolerance)	A106
DCGT	Insert (Class G tolerance)	A148	DNMG	Insert (Class M tolerance)	A109
DCGT	Insert (Class G tolerance)	A151	DNMG	Insert (Class M tolerance)	A109
DCGT	Insert (Class G tolerance)	A149	DNMG	Insert (Class M tolerance)	A107
DCGT	Insert (Class G tolerance)	A152	DNMG	Insert (Class M tolerance)	A108
DCGW	Insert (Class G tolerance)	A152	DNMG	Insert (Class M tolerance)	A107
DCK	Clamp bridge	N016	DNMG	Insert (Class M tolerance)	A107
DCLNR/L	DOUBLE CLAMP holder	C008	DNMG	Insert (Class M tolerance)	A108
DCLNR/L	DOUBLE CLAMP holder	C008	DNMG	Insert (Class M tolerance)	A110
DCMT	Insert (Class M tolerance)	A150	DNMG	Insert (Class M tolerance)	A110
DCMT	Insert (Class M tolerance)	A147	DNMG	Insert (Class M tolerance)	A109
DCMT	Insert (Class M tolerance)	A147	DNMG	Insert (Class M tolerance)	A110
DCMT	Insert (Class M tolerance)	A147	DNMG	Insert (Class M tolerance)	A107
DCMT	Insert (Class M tolerance)	A148	DNMG	Insert (Class M tolerance)	A106
DCMT	Insert (Class M tolerance)	A148	DNMG	Insert (Class M tolerance)	A107
DCMT	Insert (Class M tolerance)	A148	DNMG	Insert (Class M tolerance)	A110
DCMT	Insert (Class M tolerance)	A150	DNMG	Insert (Class M tolerance)	A111
DCMT	Insert (Class M tolerance)	A149	DNMX	Insert (Class M tolerance)	A109
DCMT	Insert (Class M tolerance)	A149	DNMX	Insert (Class M tolerance)	A107
DCMT	Insert (Class M tolerance)	A150	DTGNR/L	DOUBLE CLAMP holder	C016
DCMT	Insert (Class M tolerance)	A150	DTGNR/L	DOUBLE CLAMP holder	C016
DCMT	Insert (Class M tolerance)	A149	DVJNR/L	DOUBLE CLAMP holder	C019
DCMW	Insert (Class M tolerance)	A152, B068	DVJNR/L	DOUBLE CLAMP holder	C021
DCS	Spring	C008, C010, C017, C019–C022	DVJNR/L	DOUBLE CLAMP holder	C020
		E015–E017, H006–H011	DVJNR/L	DOUBLE CLAMP holder	C022
DCSVN32	Shim	N011	DVJNR/L	DOUBLE CLAMP holder	C022
DC	Clamp screw	N003	E		
DDJNR/L	DOUBLE CLAMP holder	C010	E	Stop ring	C019–C021
DDJNR/L	DOUBLE CLAMP holder	C010	EGS	Clamp screw	N004
DEGX	Insert (For AL holder)	A153	ESS42	Shim	N011
DEGX	Insert (For AL holder)	A153, B073	EST	Shim	N011
DKS	Clamp screw	N003	F		
DNGA	Insert (Class G tolerance)	A111, B064	FCTU	FCTU type boring bar	E028
DNGG	Insert (Class G tolerance)	A105	FC400890T	Clamp screw	N004
DNGG	Insert (Class G tolerance)	A109	FSCLC1008R/L-06A	DIMPLE BAR	E007
DNGM	Insert (Class G tolerance)	A107	FSCLC1008R/L-06E	DIMPLE BAR (Carbide shank)	E008
DNGN	Insert (Class G tolerance)	B049	FSCLC1008R-06E	DIMPLE BAR (Carbide shank)	E008
DNMA	Insert (Class M tolerance)	A111	FSCLP	DIMPLE BAR (Carbide shank)	E008
DNMG	Insert (Class M tolerance)	A109	FSCLP	DIMPLE BAR (Carbide shank)	E007
DNMG	Insert (Class M tolerance)	A105	FSCLP	DIMPLE BAR (Carbide shank)	E007
DNMG	Insert (Class M tolerance)	A105	FSCLP	DIMPLE BAR (Carbide shank)	E008
DNMG	Insert (Class M tolerance)	A105			

INDEX FOR TOOL NUMBER

Order Number	PRODUCT NAME	Page	Order Number	PRODUCT NAME	Page
RTG00A	Insert (For TL type holder)	A176, C037	SNMG000000-MA	Insert (Class M tolerance)	A115
S			SNMG000000-MH	Insert (Class M tolerance)	A115
S0	Clamp screw	N006	SNMG000000-MK	Insert (Class M tolerance)	A114
SBAHR00000	Small tools Boring holder	D030	SNMG000000-MM	Insert (Class M tolerance)	A114
SBAT000000L	Insert (For SBAHR type holder)	D030	SNMG000000-MP	Insert (Class M tolerance)	A114
SBAT000000L-B	Insert (For SBAHR type holder)	D030	SNMG000000-MS	Insert (Class M tolerance)	A114, A115
SBH00000R	Square type holder (For MICRO-DEX/ MICROMINI type boring bar)	E026, F126, G029	SNMG000000-RK	Insert (Class M tolerance)	A116
SCACR/L00000000-SM	Small tools holder (External front turning)	D010	SNMG000000-RM	Insert (Class M tolerance)	A116
SCLCR/L00000000	SP holder	C024	SNMG000000-RP	Insert (Class M tolerance)	A116
SCLCR/L00000000-SM	Small tools holder (External front turning)	D010	SNMG000000-RS	Insert (Class M tolerance)	A116
SCMT0000000	Insert (Class M tolerance)	A156	SNMG000000-SA	Insert (Class M tolerance)	A114
SCMT000000-FM	Insert (Class M tolerance)	A155	SNMG000000-SH	Insert (Class M tolerance)	A113
SCMT000000-FP	Insert (Class M tolerance)	A155	SNMG120408-SY	Insert (Class M tolerance)	A114
SCMT000000-FV	Insert (Class M tolerance)	A155	SNMM000000-HL	Insert (Class M tolerance)	A117
SCMT000000-LM	Insert (Class M tolerance)	A155	SNMM000000-HM	Insert (Class M tolerance)	A117
SCMT000000-LP	Insert (Class M tolerance)	A155	SNMM000000-HR	Insert (Class M tolerance)	A117
SCMT000000-MK	Insert (Class M tolerance)	A156	SNMM000000-HV	Insert (Class M tolerance)	A117
SCMT000000-MM	Insert (Class M tolerance)	A155	SNMM000000-HX	Insert (Class M tolerance)	A117
SCMT000000-MP	Insert (Class M tolerance)	A155	SNMM000000-HZ	Insert (Class M tolerance)	A117
SCMT000000-MS	Insert (Class M tolerance)	A156	SNMM250724-HXD	Insert (Class M tolerance)	A118
SCMW0000000	Insert (Class M tolerance)	A156	SNMN000000	Insert (Class M tolerance)	A137, K035
SD00	Set bolt	N006	SPGN000000	Insert (Class G tolerance)	A178, B061, B075, K037
SDJCR/L00000000	SP holder	C025	SPGR090304R	Insert (Class G tolerance)	A177
SDJCR/L00000000-SM	Small tools holder (External front turning)	D011	SPGX0000000	Insert (Class G tolerance)	A157, B068
SDJER/L00000015	AL holder	C034	SPMN0000000	Insert (Class M tolerance)	A177, K037
SDNCN00000000	SP holder	C025	SPMN120304T	Insert (Class M tolerance)	A177, K037
SDNCR/L00000000-SM	Small tools holder (External front turning)	D011	SPMR0000000	Insert (Class M tolerance)	A177
SDNEN00000015	AL holder	C034	SPMR120308-80	Insert (Class M tolerance)	A177
SETK00	Clamp bridge	N016	SPMT0000000	Insert (Class M tolerance)	A157
SETS00	Clamp screw	N006	SPMW0000000	Insert (Class M tolerance)	A157, J171, K038
SH000-FSDUCL00	Small tools holder SH(for Opposite post)	D026	SPSVN32	Shim	N013
SLCS000	Clamp screw	N006	SPS1	Locator screw	N006
SL3200-90	Boring bar sleeve	H022	SRDCN00000000	SP holder	C027
SNGA0000000	Insert (Class G tolerance)	A118, B043	SRGCR/L00000000	SP holder	C027
SNGG0000000R/L	Insert (Class G tolerance)	A116	SRK1R	Clamp bridge	N016
SNGN0000000	Insert (Class G tolerance)	A137, B050	SRS5	Clamp screw	N006
SNMA0000000	Insert (Class M tolerance)	A118	S000SCLCR/L00	S type boring bar (Steel shank)	E032
SNMG0000000	Insert (Class M tolerance)	A115	S000SCZCR/L00	S type boring bar (Steel shank)	E036
SNMG000000-FH	Insert (Class M tolerance)	A113	S000SDQCR/L00	S type boring bar (Steel shank)	E033
SNMG000000-FP	Insert (Class M tolerance)	A113	S000SDUCR/L00	S type boring bar (Steel shank)	E031
SNMG000000-FS	Insert (Class M tolerance)	A113	SSSCR/L00000000	SP holder	C028
SNMG000000-GH	Insert (Class M tolerance)	A117	S000SSKCR/L00	S type boring bar (Steel shank)	E035
SNMG000000-GK	Insert (Class M tolerance)	A115	S000STFCR/L00	S type boring bar (Steel shank)	E030
SNMG000000-GM	Insert (Class M tolerance)	A115	S000STFER/L16	AL type boring bar (Steel shank)	E041
SNMG000000-LK	Insert (Class M tolerance)	A113	S000SVQCR/L00	S type boring bar (Steel shank)	E034
SNMG000000-LM	Insert (Class M tolerance)	A113	S000SVUCR/L00	S type boring bar (Steel shank)	E035
SNMG000000-LP	Insert (Class M tolerance)	A113	STASX0000N	Shim	N013
			STBS500N	Shim	N013
			STFER/L00000016	AL holder	C035

Order Number	PRODUCT NAME	Page	Order Number	PRODUCT NAME	Page
STGCR/L	SP holder	C029	TNMG	Insert (Class M tolerance)	A122
STGER/L16	AL holder	C035	TNMG-FH	Insert (Class M tolerance)	A119
STS1	Shim screw	N006	TNMG-FP	Insert (Class M tolerance)	A119
SVJBR/L-SM	Small tools holder (External front turning)	D012	TNMG-FS	Insert (Class M tolerance)	A119
SVJCR/L	SP holder	C030	TNMG-FY	Insert (Class M tolerance)	A119
SVJCR/L-SM	Small tools holder (External front turning)	D013	TNMG-GH	Insert (Class M tolerance)	A124
SVJDR/L16	AL holder	C036	TNMG-GK	Insert (Class M tolerance)	A121
SVLPR/L-SM	Small tools holder (External front turning)	D012	TNMG-GM	Insert (Class M tolerance)	A122
SVPCR/L16	SP holder	C031	TNMG-LK	Insert (Class M tolerance)	A120
SVPPR/L-SM	Small tools holder (External front turning)	D013	TNMG-LM	Insert (Class M tolerance)	A120
SVVBR/L-SM	Small tools holder (External front turning)	D013	TNMG-LP	Insert (Class M tolerance)	A120
SVVCN16	SP holder	C030	TNMG-LS	Insert (Class M tolerance)	A120
SXZCR/L15	Profile holder	C032	TNMG-MA	Insert (Class M tolerance)	A122
T			TNMG-MH	Insert (Class M tolerance)	A122
TBGN	Insert (Class G tolerance)	B062	TNMG-MJ	Insert (Class M tolerance)	A121
TCGN	Insert (Class G tolerance)	A179	TNMG-MK	Insert (Class M tolerance)	A121
TCGT-AZ	Insert (Class G tolerance)	A158	TNMG-MM	Insert (Class M tolerance)	A121
TCGT-MR/L-F	Insert (Class G tolerance)	A141	TNMG-MP	Insert (Class M tolerance)	A121
TCGT-R/L-F	Insert (Class G tolerance)	A158	TNMG-MS	Insert (Class M tolerance)	A121
TCGW	Insert (Class G tolerance)	B069	TNMG-RK	Insert (Class M tolerance)	A124
TCMT	Insert (Class M tolerance)	A160	TNMG-R/L-ES	Insert (Class M tolerance)	A123
TCMT-FM	Insert (Class M tolerance)	A158	TNMG-R/L-2G	Insert (Class M tolerance)	A123
TCMT-FP	Insert (Class M tolerance)	A158	TNMG-RM	Insert (Class M tolerance)	A123
TCMT-FV	Insert (Class M tolerance)	A158	TNMG-RP	Insert (Class M tolerance)	A123
TCMT-LM	Insert (Class M tolerance)	A159	TNMG-RS	Insert (Class M tolerance)	A124
TCMT-LP	Insert (Class M tolerance)	A159	TNMG-SA	Insert (Class M tolerance)	A120
TCMT-LS	Insert (Class M tolerance)	A159	TNMG-SH	Insert (Class M tolerance)	A120
TCMT-MK	Insert (Class M tolerance)	A159	TNMG-SY	Insert (Class M tolerance)	A121
TCMT-MM	Insert (Class M tolerance)	A159	TNMM-HL	Insert (Class M tolerance)	A124
TCMT-MP	Insert (Class M tolerance)	A159	TNMM-HZ	Insert (Class M tolerance)	A124
TCMT-MS	Insert (Class M tolerance)	A159	TNMN	Insert (Class M tolerance)	A138
TCMW	Insert (Class M tolerance)	A160, B069	TNMX-MW	Insert (Class M tolerance)	A123
TEGX	Insert (For AL holder)	B060	TNMX-SW	Insert (Class M tolerance)	A120
TEGX-R/L	Insert (For AL holder)	A161, B073	TPGH-R/L-FS	Insert (Class G tolerance)	A162
TIP	Wrench	N002	TPGN	Insert (Class G tolerance)	A181, B062, B075
TKYD	Driver	N002	TPGR-R/L	Insert (Class G tolerance)	A180
TKYF	Flag wrench	N002	TPGX	Insert (Class G tolerance)	A163, B070, K042
TKYL	Long wrench	N002	TPGX-R/L	Insert (Class G tolerance)	A162, A163
TKYR	L-wrench	N002	TPMH-FV	Insert (Class M tolerance)	A162
TKYT	T-wrench	N002	TPMH-MV	Insert (Class M tolerance)	A163
TKYW	Flag wrench	N002	TPMH-SV	Insert (Class M tolerance)	A163
TLHR	TL holder	C037	TPMN	Insert (Class M tolerance)	A180, K042
TNGA	Insert (Class G tolerance)	A125, B045, B065	TPMN220408T	Insert (Class M tolerance)	A180, K042
TNGG-R/L	Insert (Class G tolerance)	A123	TPMR	Insert (Class M tolerance)	A180
TNGG-R/L-F	Insert (Class G tolerance)	A119	TPMR-80	Insert (Class M tolerance)	A180
TNGG-R/L-FS	Insert (Class G tolerance)	A119	TPMX	Insert (Class M tolerance)	A163
TNGG-R/L-K	Insert (Class G tolerance)	A121	TPMX-L	Insert (Class M tolerance)	A163
TNGN	Insert (Class G tolerance)	A138, B050	TPS	Clamp screw	N008
TNMA	Insert (Class M tolerance)	A125	TPS	Clamp screw	N008
			TPS	Clamp screw	N008

INDEX FOR TOOL NUMBER

Order Number	PRODUCT NAME	Page	Order Number	PRODUCT NAME	Page
TPS○○○○○	Clamp screw	N008	VCMT○○○○○○○-MV	Insert (Class M tolerance)	A169
TPS○○-1	Clamp screw	N008	VCMT○○○○○○○-SV	Insert (Class M tolerance)	A168
TS○	Clamp screw	N007	VCMW○○○○○○○	Insert (Class M tolerance)	A169
TS○○	Clamp screw	N007	VDGX○○○○○○○R-F	Insert (Class G tolerance)	B074
TS○○○	Clamp screw	N007	VDGX○○○○○○○R/L	Insert (Class G tolerance)	A170
TS○○○○	Clamp screw	N007	VNGA○○○○○○○	Insert (Class G tolerance)	A129, B056
TSR○○○○○S	Clamp screw	N008	VNGG○○○○○○○-FJ	Insert (Class G tolerance)	A126
TSS○○○○○	Radial screw	N008	VNGG○○○○○○○R/L	Insert (Class G tolerance)	A129
TSS○○○○○S	Clamp screw	N008	VNGG○○○○○○○R/L-F	Insert (Class G tolerance)	A126
TTAHR/L○○○○○	Small tools holder (External threading)	D024	VNGM○○○○○○○-MJ	Insert (Class G tolerance)	A127
TTAT○○○○○○○○○-B	Insert for external threading	D024	VNMA○○○○○○○	Insert (Class M tolerance)	A129
U			VNMG○○○○○○○	Insert (Class M tolerance)	A128
UCR	Clamp bridge	N016	VNMG○○○○○○○-FH	Insert (Class M tolerance)	A126
V			VNMG○○○○○○○-FP	Insert (Class M tolerance)	A126
VBET○○○○○○○R/L-SN	Insert (Class E tolerance)	A166	VNMG○○○○○○○-FS	Insert (Class M tolerance)	A126
VBET○○○○○○○R/L-SR	Insert (Class E tolerance)	A166	VNMG○○○○○○○-GK	Insert (Class M tolerance)	A128
VBET○○○○○○○R/LW-SN	Insert (Class E tolerance)	A166	VNMG○○○○○○○-GM	Insert (Class M tolerance)	A128
VBGT○○○○○○○R/L-F	Insert (Class G tolerance)	A164	VNMG○○○○○○○-LK	Insert (Class M tolerance)	A127
VBMT○○○○○○○	Insert (Class M tolerance)	A165	VNMG○○○○○○○-LM	Insert (Class M tolerance)	A126
VBMT○○○○○○○-FM	Insert (Class M tolerance)	A164	VNMG○○○○○○○-LP	Insert (Class M tolerance)	A126
VBMT○○○○○○○-FP	Insert (Class M tolerance)	A164	VNMG○○○○○○○-LS	Insert (Class M tolerance)	A127
VBMT○○○○○○○-FV	Insert (Class M tolerance)	A164	VNMG○○○○○○○-MA	Insert (Class M tolerance)	A128
VBMT○○○○○○○-LM	Insert (Class M tolerance)	A164	VNMG○○○○○○○-MH	Insert (Class M tolerance)	A128
VBMT○○○○○○○-LP	Insert (Class M tolerance)	A164	VNMG○○○○○○○-MJ	Insert (Class M tolerance)	A127
VBMT○○○○○○○-LS	Insert (Class M tolerance)	A165	VNMG○○○○○○○-MK	Insert (Class M tolerance)	A127
VBMT○○○○○○○-MK	Insert (Class M tolerance)	A165	VNMG○○○○○○○-MP	Insert (Class M tolerance)	A127
VBMT○○○○○○○-MM	Insert (Class M tolerance)	A165	VNMG○○○○○○○-MS	Insert (Class M tolerance)	A128
VBMT○○○○○○○-MP	Insert (Class M tolerance)	A165	VNMG○○○○○○○-SA	Insert (Class M tolerance)	A127
VBMT○○○○○○○-MS	Insert (Class M tolerance)	A165	VNMG○○○○○○○-SH	Insert (Class M tolerance)	A127
VBMT○○○○○○○-MV	Insert (Class M tolerance)	A165	VNMG160408-MM	Insert (Class M tolerance)	A127
VBMT○○○○○○○-SV	Insert (Class M tolerance)	A165	VPET○○○○○○○-SRF	Insert (Class E tolerance)	A171
VBMW160408	Insert (Class M tolerance)	A166	VPGT○○○○○○○M-SMG	Insert (Class G tolerance)	A171
VCGT○○○○○○○-AZ	Insert (Class G tolerance)	A167	W		
VCGT○○○○○○○M-LS	Insert (Class G tolerance)	A168	WBGD○○○○○○○R/L-F	Insert (Class G tolerance)	A172
VCGT○○○○○○○M-LS-P	Insert (Class G tolerance)	A168	WBMT○○○○○○○R/L-MV	Insert (Class M tolerance)	A172
VCGT○○○○○○○R/L-F	Insert (Class G tolerance)	A167	WCGT○○○○○○○R/L	Insert (Class G tolerance)	A173
VCGW1103○○	Insert (Class G tolerance)	B071	WCMT○○○○○○○	Insert (Class M tolerance)	A173
VCMT○○○○○○○	Insert (Class M tolerance)	A169	WCMW06T304	Insert (Class M tolerance)	B072
VCMT○○○○○○○-FM	Insert (Class M tolerance)	A167	WCS○○○○○○○H	Shim screw	N008
VCMT○○○○○○○-FP	Insert (Class M tolerance)	A167	WNMA○○○○○○○	Insert (Class M tolerance)	A134
VCMT○○○○○○○-FV	Insert (Class M tolerance)	A167	WNMG○○○○○○○	Insert (Class M tolerance)	A133
VCMT○○○○○○○-LM	Insert (Class M tolerance)	A167	WNMG○○○○○○○-FH	Insert (Class M tolerance)	A130
VCMT○○○○○○○-LP	Insert (Class M tolerance)	A167	WNMG○○○○○○○-FP	Insert (Class M tolerance)	A130
VCMT○○○○○○○-LS	Insert (Class M tolerance)	A168	WNMG○○○○○○○-FS	Insert (Class M tolerance)	A130
VCMT○○○○○○○-MK	Insert (Class M tolerance)	A169	WNMG○○○○○○○-FY	Insert (Class M tolerance)	A130
VCMT○○○○○○○-MM	Insert (Class M tolerance)	A168	WNMG○○○○○○○-GH	Insert (Class M tolerance)	A134
VCMT○○○○○○○-MP	Insert (Class M tolerance)	A168	WNMG○○○○○○○-GJ	Insert (Class M tolerance)	A134
VCMT○○○○○○○-MS	Insert (Class M tolerance)	A169	WNMG○○○○○○○-GK	Insert (Class M tolerance)	A133
			WNMG○○○○○○○-GM	Insert (Class M tolerance)	A133

Order Number	PRODUCT NAME	Page	Order Number	PRODUCT NAME	Page
WNUMG○○○○○○○-LKInsert (Class M tolerance)	A131			
WNUMG○○○○○○○-LMInsert (Class M tolerance)	A130			
WNUMG○○○○○○○-LPInsert (Class M tolerance)	A130			
WNUMG○○○○○○○-LSInsert (Class M tolerance)	A131			
WNUMG○○○○○○○-MAInsert (Class M tolerance)	A133			
WNUMG○○○○○○○-MHInsert (Class M tolerance)	A133			
WNUMG○○○○○○○-MJInsert (Class M tolerance)	A131			
WNUMG○○○○○○○-MKInsert (Class M tolerance)	A132			
WNUMG○○○○○○○-MMInsert (Class M tolerance)	A132			
WNUMG○○○○○○○-MPInsert (Class M tolerance)	A132			
WNUMG○○○○○○○-MSInsert (Class M tolerance)	A132			
WNUMG○○○○○○○-MWInsert (Class M tolerance)	A133			
WNUMG○○○○○○○-RKInsert (Class M tolerance)	A134			
WNUMG○○○○○○○-RMInsert (Class M tolerance)	A133			
WNUMG○○○○○○○-RPInsert (Class M tolerance)	A133			
WNUMG○○○○○○○-RSInsert (Class M tolerance)	A134			
WNUMG○○○○○○○-SAInsert (Class M tolerance)	A131			
WNUMG○○○○○○○-SHInsert (Class M tolerance)	A131			
WNUMG○○○○○○○-SWInsert (Class M tolerance)	A131			
WNUMG○○○○○○○-SYInsert (Class M tolerance)	A131			
WPGT○○○○○○○Insert (Class G tolerance)	B072			
WPGT○○○○○○○R/L-FSInsert (Class G tolerance)	A174			
WPMT○○○○○○○-MVInsert (Class M tolerance)	A174			
WPSTN○○○Shim	N013			
WPSWC43Shim	N013			
WPSWN43Shim	N013			
WS○○○○○○○TClamp screw	N008			
WS○○○○○○○TPSClamp screw	N008			
X					
XCMT○○○○○○○-SVXInsert (Class M tolerance)	A175			

WORLDWIDE



MITSUBISHI MATERIALS CORPORATION - METALWORKING SOLUTIONS COMPANY A SYNERGY FOR SUCCESS

The Metalworking Solutions division of Mitsubishi Materials is dedicated to the development and processing of metals, cutting materials, coatings and precision tools. Profound know-how and many years of experience in manufacturing technology makes Mitsubishi Materials one of the leading suppliers in the precision cutting tool market.

The company's global market presence, with headquarters and sales offices in Japan, Europe, India, Brazil, China, Thailand, Mexico and the US, as well as a broad network of international distributors, ensures a targeted, comprehensive service.

Information exchange and technology transfer, open communication and growing synergies guarantee maximum performance and sustainable customer success.

METALWORKING SOLUTIONS COMPANY

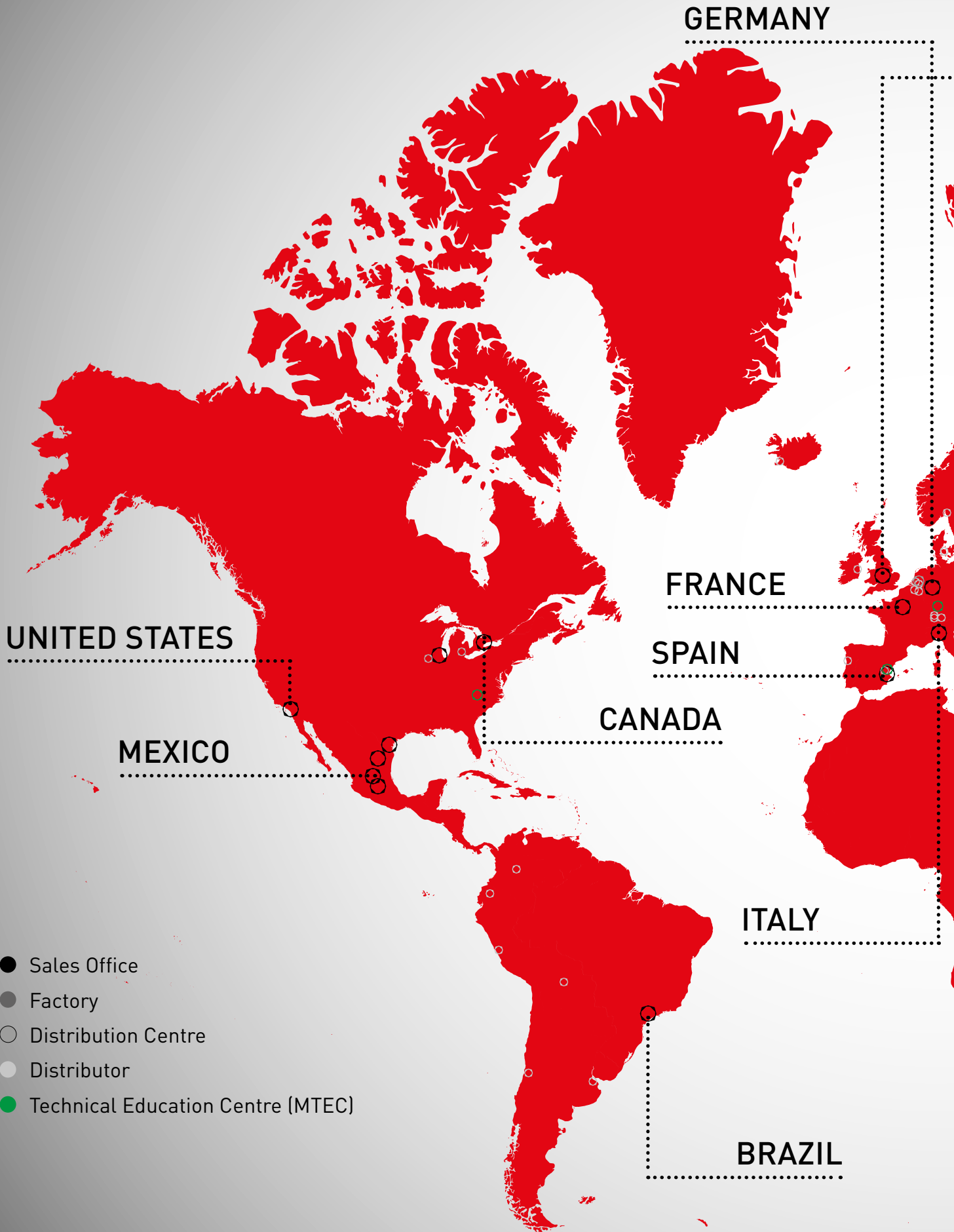



MITSUBISHI MATERIALS CORPORATION

GERMANY

MMC HARTMETALL GMBH
Comeniusstr. 2 . 40670 Meerbusch
Phone +49 2159 91890 . Fax +49 2159 918966
Email admin@mmchg.de

U.K.

MMC HARDMETAL U.K. LTD.
Mitsubishi House . Galena Close . Tamworth . Staffs. B77 4AS
Phone +44 1827 312312 . Fax +44 1827 312314
Email sales@mitsubishicarbide.co.uk

SPAIN

MITSUBISHI MATERIALS ESPAÑA, S.A.
Calle Emperador 2 . 46136 Museros/Valencia
Phone +34 96 1441711 . Fax +34 96 1443786
Email comercial@mmevalencia.es

FRANCE

MMC METAL FRANCE S.A.R.L.
6, Rue Jacques Monod . 91400 Orsay
Phone +33 1 69 35 53 53 . Fax +33 1 69 35 53 50
Email mmfsales@mmc-metal-france.fr

POLAND

MMC HARDMETAL POLAND SP. Z O.O
Al. Armii Krajowej 61 . 50 - 541 Wrocław
Phone +48 71335 1620 . Fax +48 71335 1621
Email sales@mitsubishicarbide.com.pl

RUSSIA

MMC HARDMETAL OOO LTD.
Electrozavodskaya St. 24 . build. 3 . Moscow . 107023
Phone +7 495 725 58 85 . Fax +7 495 981 39 79
Email info@mmc-carbide.ru

ITALY

MMC ITALIA S.R.L.
Viale Certosa 144 . 20156 Milano
Phone +39 0293 77031 . Fax +39 0293 589093
Email info@mmc-italia.it

TURKEY

MMC HARTMETALL GMBH ALMANYA - İZMİR MERKEZ ŞUBESİ
Adalet Mahallesi Anadolu Caddesi No: 41-1 . 15001 35530 Bayraklı/İzmir
Phone +90 232 5015000 . Fax +90 232 5015007
Email info@mmchg.com.tr

www.mitsubishicarbide.com | www.mmc-hardmetal.com