

MACH
Supersonic
Threading

**UNMATCHED
PRODUCTIVITY**

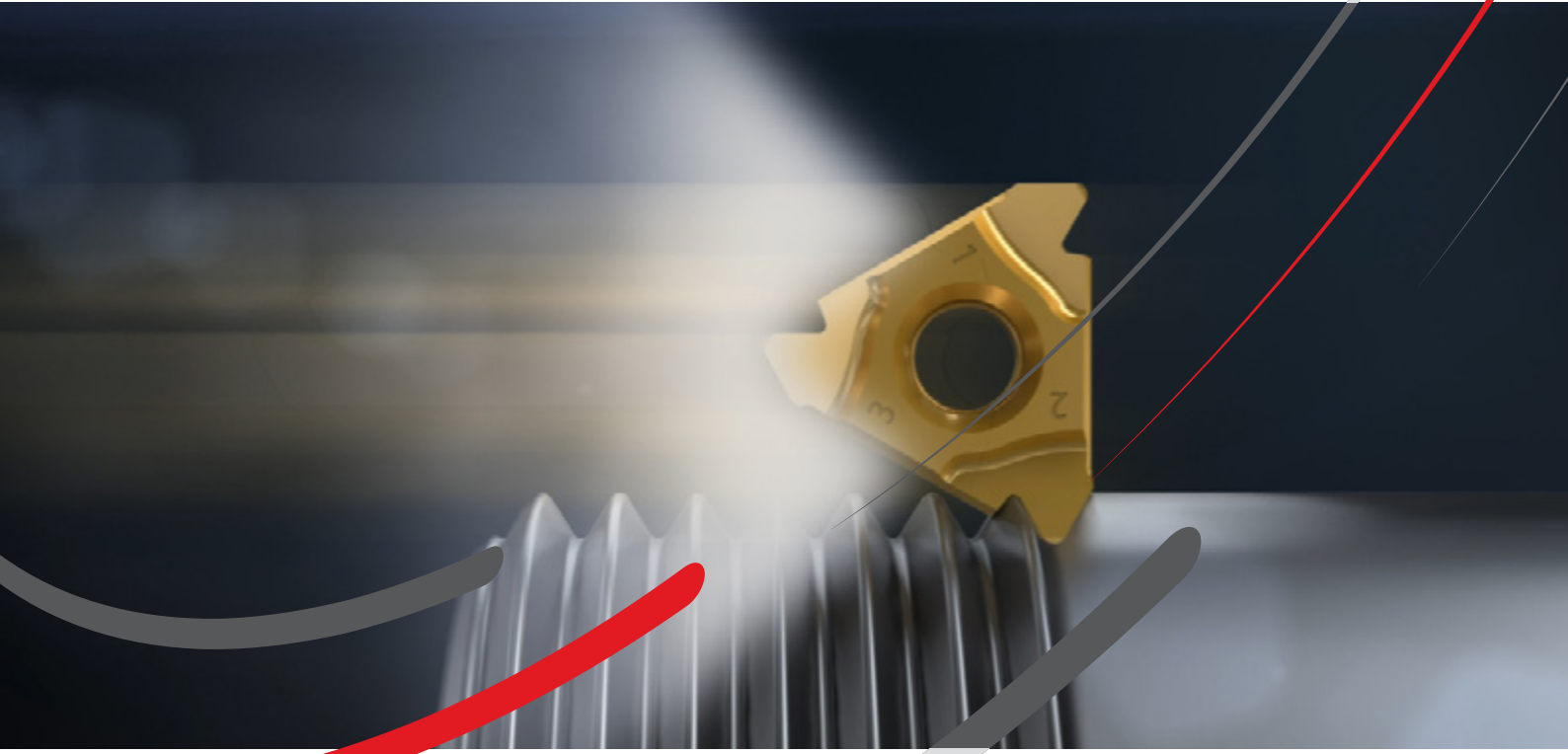

METRIC

UNMATCHED PRODUCTIVITY

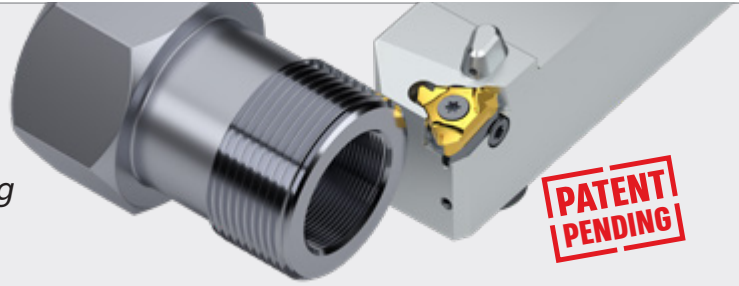

**PATENT
PENDING**

Features and Innovations 4

MACH TT External Inserts

Partial Profile 60° 6

Partial Profile 55° 6

ISO Metric 6

American UN 7

Whitworth for BSW, BSP 7

BSPT 8

NPT 8

NPTF 8

Round (405) 9

Trapez 9

UNJ 10

MJ 10

Metric Buttress (Sägengewinde) 11

API Round 11

MACH TT External Holders

Standard with Coolant (HPC) 12

Standard 12

Standard with Coolant (HPC)
for Swiss Type Machines 13

Technical Data 14

Anvils 15



Features and Innovations 16

MACH TM Solid Tools

ISO Metric 18

American UN 19

BSP 19

NPT 20

Technical Data 21



MORE THAN 2 TIMES FASTER



Standard

15 Passes | 40 sec.

Application:
M64x3.0x33

Material:
SAE 4140

Cutting Speed:
 $V_c = 100$ m/min

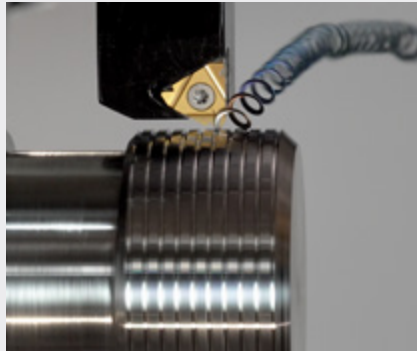

MACHTM

6 Passes | 15 sec.

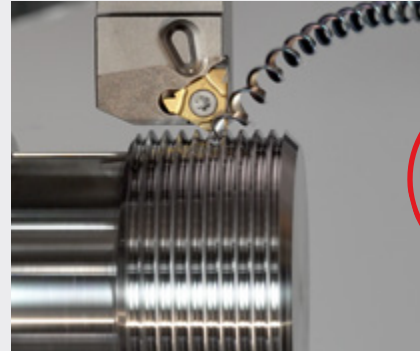

60% less passes
60% less machining time
25% more tool life

Standard (3 Flutes)

feed 0.15 mm/rev | 7 sec.

Application:
M10x1.5x20

Material:
SAE 4140

Cutting Speed:
 $V_c = 90$ m/min

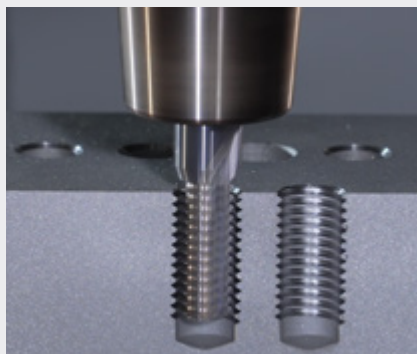

MACHTM (4 Flutes)

feed 0.4 mm/rev | 3 sec.

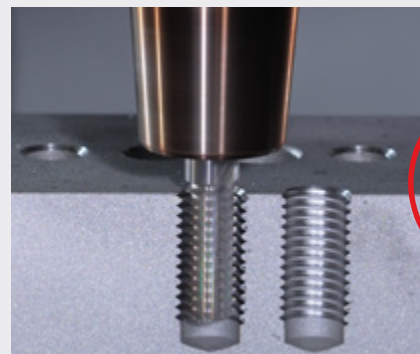

100% higher feed (mm/flute)
60% less machining time
25% more tool life



Improved Rake & Reinforced Geometry

For high resistance with a reduced number of passes

VK8 Grade

High wear resistance for general purpose applications
AlTiN + TiN PVD coating

Improved Profile Design

Superior threading surface finish

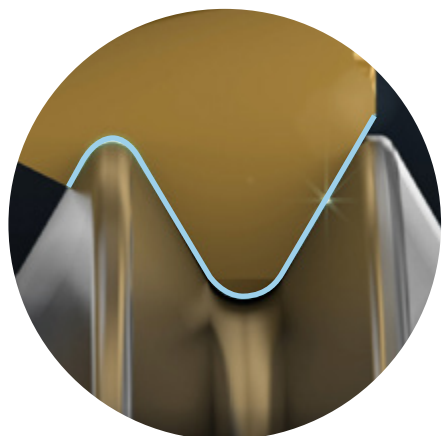

Advanced Surface Treatment

Reinforced cutting edge and smooth surface finish

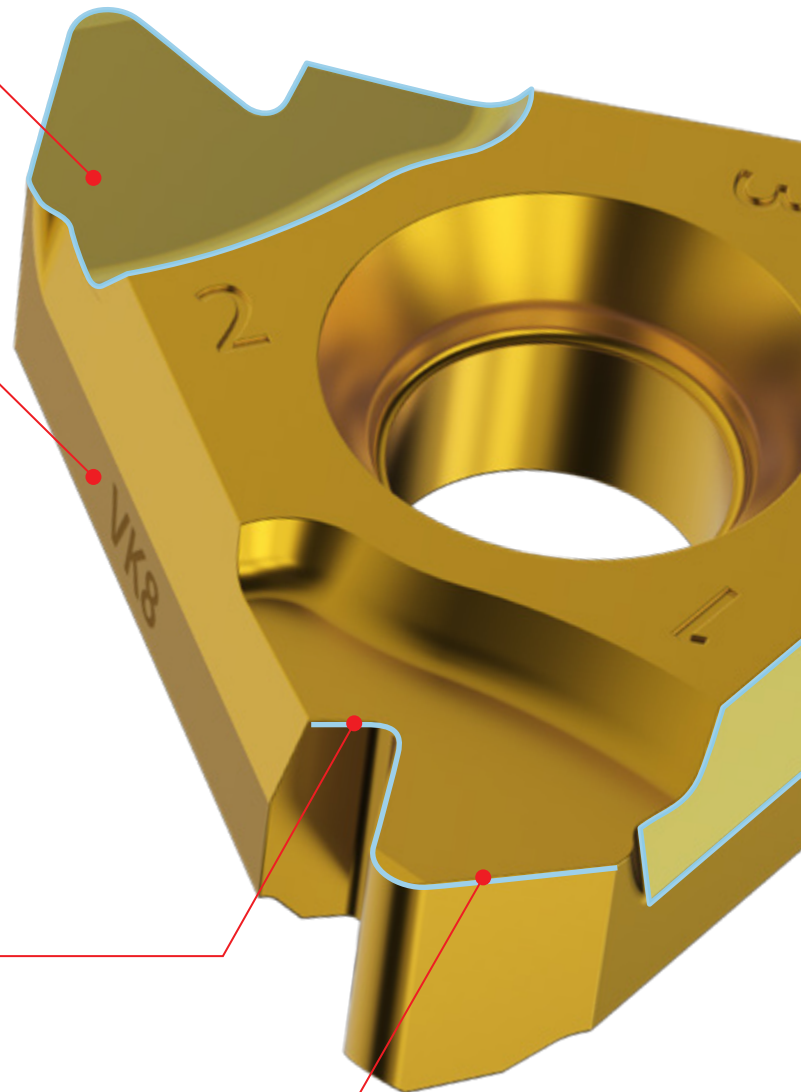



UNMATCHED PRODUCTIVITY

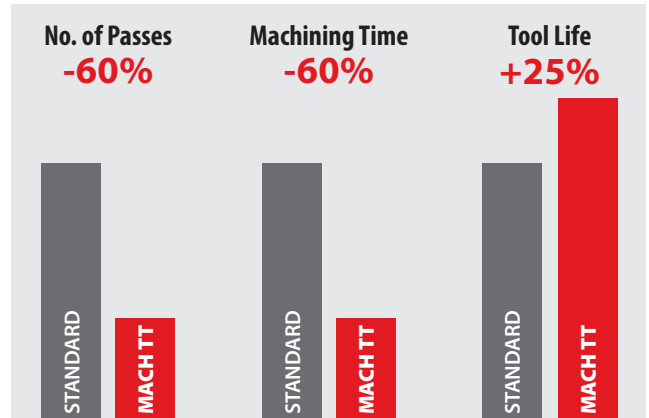

PATENT PENDING

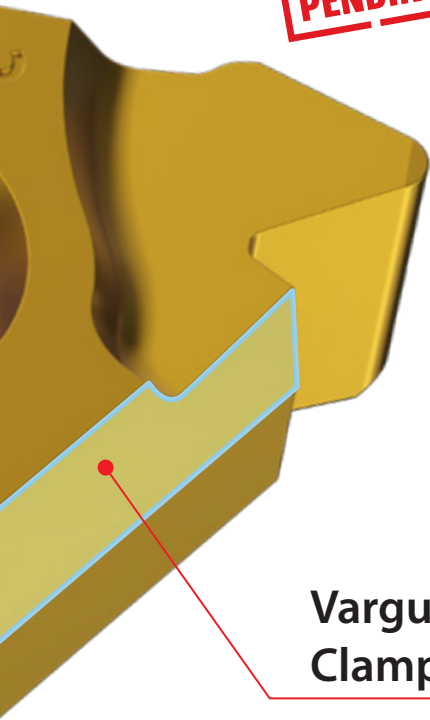

Vargus Dovetail Clamping System

Super rigid - designed for high loads

ADVANTAGES

- ✓ Significantly reduces the number of passes
- ✓ Dramatically decreases machining time
- ✓ Extended tool life
- ✓ Excellent surface finish

SUPER RIGID
MACH TT

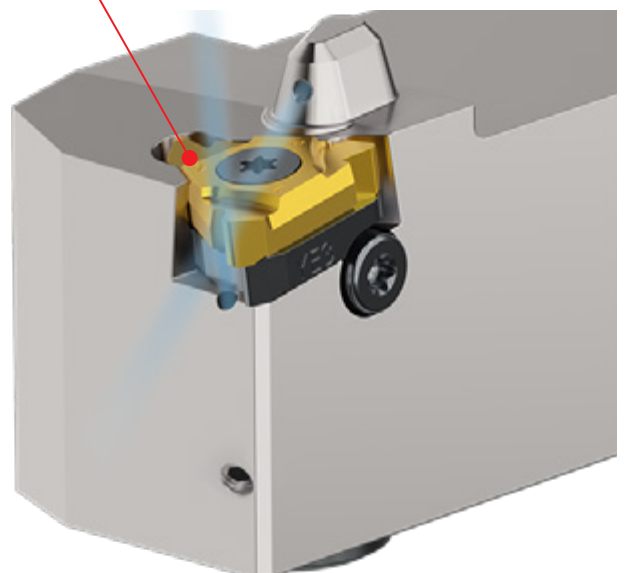
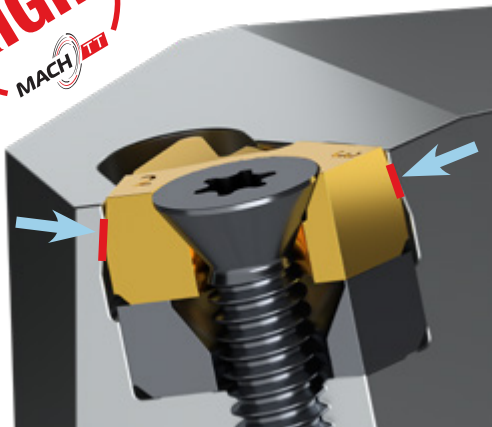

External

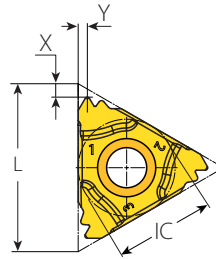

Partial Profile 60°

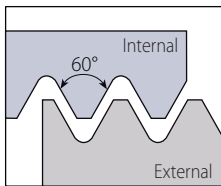

	Insert Size		Pitch		Ordering Code	Market Description	Dimensions mm			Anvil	
	IC	L mm	mm	TPI	RH		r	X	Y	RH	Toolholder
External	3/8"	16	0.5-1.5	48-16	3DTERA60...	16DTERA60...	0.05	1.5	1.4		
			1.75-3.0	14-8	3DTERG60... *	16DTERG60... *	0.27	1.4	1.7	YE3	AL....-3DT
			0.5-3.0	48-8	3DTERA60... *	16DTERA60... *	0.08	1.1	1.7		

Partial Profile 55°

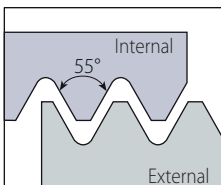

	Insert Size		Pitch		Ordering Code	Market Description	Dimensions mm			Anvil	
	IC	L mm	mm	TPI	RH		r	X	Y	RH	Toolholder
External	3/8"	16	0.5-1.5	48-16	3DTERA55... *	16DTERA55... *	0.05	1.5	1.5		
			0.5-3.0	48-8	3DTERAG55... *	16DTERAG55... *	0.07	1.1	1.7	YE3	AL....-3DT
			1.75-3.0	14-8	3DTERG55... *	16DTERG55... *	0.21	1.1	1.6		

External

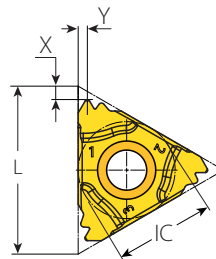

ISO Metric

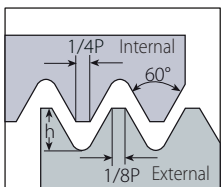

Defined by: DIN 13
Tolerance class: 6g

	Insert Size		Pitch	Ordering Code	Market Description	Dimensions mm			Anvil	
	IC	L mm	mm	RH		h min	X	Y	RH	Toolholder
External	3/8"	16	0.7	3DTER0.7ISO... *	16DTER0.7ISO... *	0.43	1.6	0.5		
			0.75	3DTER0.75ISO... *	16DTER0.75ISO... *	0.46	1.6	0.5		
			0.8	3DTER0.8ISO... *	16DTER0.8ISO... *	0.49	1.6	0.6		
			1.0	3DTER1.0ISO... *	16DTER1.0ISO... *	0.61	1.5	0.6		
			1.25	3DTER1.25ISO... *	16DTER1.25ISO... *	0.77	1.5	0.8		
			1.5	3DTER1.5ISO... *	16DTER1.5ISO... *	0.92	1.4	0.9	YE3	AL....-3DT
			1.75	3DTER1.75ISO... *	16DTER1.75ISO... *	1.07	1.4	1.2		
			2.0	3DTER2.0ISO... *	16DTER2.0ISO... *	1.23	1.4	1.3		
			2.5	3DTER2.5ISO... *	16DTER2.5ISO... *	1.53	1.4	1.4		
			3.0	3DTER3.0ISO... *	16DTER3.0ISO... *	1.84	1.3	1.5		
			3.5	3DTER3.5ISO... *	16DTER3.5ISO... *	2.15	1.3	1.8		

* Available in Q2 2022

External

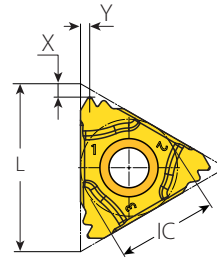

American UN

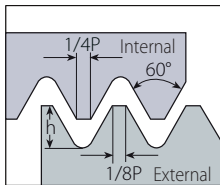

Defined by: ANSI B1.1
Tolerance class: 2A

	Insert Size		Pitch	Ordering Code	Market Description	Dimensions mm			Anvil	
	IC	L mm	TPI	RH		h min	X	Y	RH	Toolholder
External	3/8"	16	32	3DTER32UN... *	16DTER32UN... *	0.49	1.6	0.6	YE3	AL....-3DT
			28	3DTER28UN... *	16DTER28UN... *	0.56	1.6	0.6		
			27	3DTER27UN... *	16DTER27UN... *	0.58	1.6	0.6		
			24	3DTER24UN... *	16DTER24UN... *	0.65	1.5	0.7		
			20	3DTER20UN... *	16DTER20UN... *	0.78	1.5	0.8		
			18	3DTER18UN... *	16DTER18UN... *	0.87	1.4	0.9		
			16	3DTER16UN... *	16DTER16UN... *	0.97	1.4	1.0		
			14	3DTER14UN... *	16DTER14UN... *	1.11	1.4	1.2		
			13	3DTER13UN... *	16DTER13UN... *	1.20	1.4	1.3		
			12	3DTER12UN... *	16DTER12UN... *	1.30	1.4	1.4		
			11.5	3DTER11.5UN... *	16DTER11.5UN... *	1.35	1.4	1.4		
			11	3DTER11UN... *	16DTER11UN... *	1.42	1.4	1.4		
			10	3DTER10UN... *	16DTER10UN... *	1.56	1.4	1.7		
			9	3DTER9UN... *	16DTER9UN... *	1.73	1.4	1.6		
8	3DTER8UN... *	16DTER8UN... *	1.95	1.3	1.6					

Whitworth for BSW, BSP

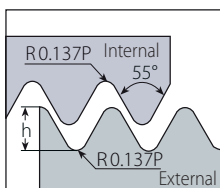

Defined by:
B.S.84:1956, DIN 259,
ISO228/1:1982
Tolerance class:
Medium class A

	Insert Size		Pitch	Ordering Code	Market Description	Dimensions mm			Anvil	
	IC	L mm	TPI	RH		h min	X	Y	RH	Toolholder
External	3/8"	16	28	3DTER28W... *	16DTER28W... *	0.58	1.6	0.6	YE3	AL....-3DT
			26	3DTER26W... *	16DTER26W... *	0.63	1.6	0.6		
			20	3DTER20W... *	16DTER20W... *	0.81	1.5	0.7		
			19	3DTER19W... *	16DTER19W... *	0.86	1.5	0.8		
			18	3DTER18W... *	16DTER18W... *	0.90	1.4	1.3		
			16	3DTER16W... *	16DTER16W... *	1.02	1.4	1.4		
			14	3DTER14W... *	16DTER14W... *	1.16	1.4	1.2		
			12	3DTER12W... *	16DTER12W... *	1.36	1.4	1.3		
			11	3DTER11W... *	16DTER11W... *	1.48	1.4	1.3		
			10	3DTER10W... *	16DTER10W... *	1.63	1.4	1.3		
			9	3DTER9W... *	16DTER9W... *	1.81	1.4	1.7		
8	3DTER8W... *	16DTER8W... *	2.03	1.1	1.5					

* Available in Q2 2022

External

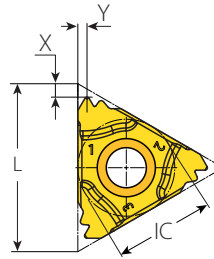

BSPT

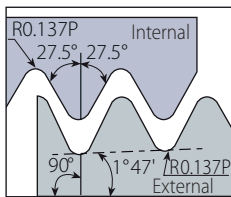

	Insert Size		Ordering Code	Market Description	Dimensions mm			Anvil		
	IC	L mm	TPI	RH	h min	X	Y	RH	Toolholder	
External	3/8"	16	28	3DTER28BSPT... *	16DTER28BSPT... *	0.58	1.6	0.6	YE3	AL....-3DT
			19	3DTER19BSPT... *	16DTER19BSPT... *	0.86	1.5	0.8		
			14	3DTER14BSPT... *	16DTER14BSPT... *	1.16	1.4	1.4		
			11	3DTER11BSPT... *	16DTER11BSPT... *	1.48	1.4	1.5		

Defined by: B.S. 21:1985
Tolerance class:
Standard BSPT

NPT

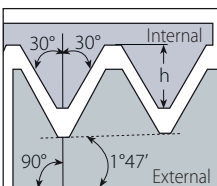

	Insert Size		Pitch	Ordering Code	Market Description	Dimensions mm			Anvil	
	IC	L mm	TPI	RH	h min	X	Y	RH	Toolholder	
External	3/8"	16	27	3DTER27NPT... *	16DTER27NPT... *	0.66	1.6	0.8	YE3	AL....-3DT
			18	3DTER18NPT... *	16DTER18NPT... *	1.01	1.5	0.9		
			14	3DTER14NPT... *	16DTER14NPT... *	1.33	1.5	1.4		
			11.5	3DTER11.5NPT... *	16DTER11.5NPT... *	1.64	1.5	1.4		
			8	3DTER8NPT... *	16DTER8NPT... *	2.42	1.2	1.8		

Defined by:
ANSI B1.20.1-1983
Tolerance class:
Standard NPT

NPTF

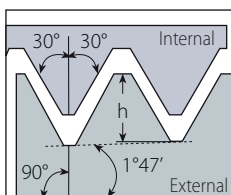

	Insert Size		Pitch	Ordering Code	Market Description	Dimensions mm			Anvil	
	IC	L mm	TPI	RH	h min	X	Y	RH	Toolholder	
External	3/8"	16	27	3DTER27NPTF... *	16DTER27NPTF... *	0.64	1.6	0.8	YE3	AL....-3DT
			18	3DTER18NPTF... *	16DTER18NPTF... *	1.00	1.5	1.4		
			14	3DTER14NPTF... *	16DTER14NPTF... *	1.35	1.5	1.4		
			11.5	3DTER11.5NPTF... *	16DTER11.5NPTF... *	1.63	1.5	1.4		
			8	3DTER8NPTF... *	16DTER8NPTF... *	2.38	1.2	1.7		

Defined by:
ANSI B1.20.3-1976
Tolerance class:
Standard NPTF

* Available in Q2 2022

External

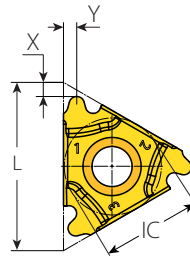

Round (405)

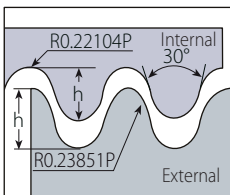

	Insert Size		Pitch	Ordering Code	Market Description	Dimensions mm			Anvil	
	IC	L mm	TPI	RH		h min	X	Y	RH	Toolholder
External	3/8"	16	8	3DTER8RD... *	16DTER8RD... *	1.59	1.4	1.3	YE3	AL....-3DT
			6	3DTER6RD... *	16DTER6RD... *	2.12	1.4	1.7		

Defined by: DIN 405
Tolerance class: 7h

External

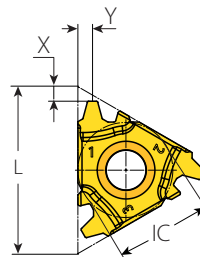

Trapez

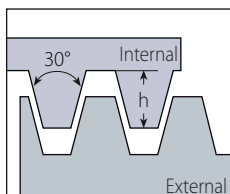

	Insert Size		Pitch	Ordering Code	Market Description	Dimensions mm			Anvil	
	IC	L mm	mm	RH		h min	X	Y	RH	Toolholder
External	3/8"	16	1.5	3DTER1.5TR... *	16DTER1.5TR... *	0.90	1.5	1.4	YE3	AL....-3DT
			2.0	3DTER2.0TR... *	16DTER2.0TR... *	1.25	1.5	1.4		
			3.0	3DTER3.0TR... *	16DTER3.0TR... *	1.75	1.4	1.5		

Defined by: DIN 103
Tolerance class: 7e

* Available in Q2 2022

External

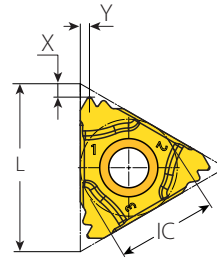

UNJ

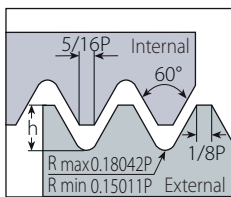

Defined by: MIL-S-8879C
Tolerance class: 3A

	Insert Size		Pitch	Ordering Code	Market Description	Dimensions mm			Anvil	
	IC	L mm	TPI	RH		h min	X	Y	RH	Toolholder
External	3/8"	16	32	3DTER32UNJ... *	16DTER32UNJ... *	0.46	1.6	0.6	YE3	AL....-3DT
			28	3DTER28UNJ... *	16DTER28UNJ... *	0.52	1.5	0.6		
			24	3DTER24UNJ... *	16DTER24UNJ... *	0.61	1.5	0.7		
			20	3DTER20UNJ... *	16DTER20UNJ... *	0.73	1.5	0.8		
			18	3DTER18UNJ... *	16DTER18UNJ... *	0.81	1.4	0.8		
			16	3DTER16UNJ... *	16DTER16UNJ... *	0.92	1.4	0.9		
			14	3DTER14UNJ... *	16DTER14UNJ... *	1.05	1.4	1.2		
12	3DTER12UNJ... *	16DTER12UNJ... *	1.22	1.4	1.2					

MJ

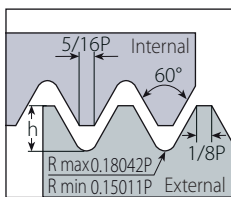

Defined by: ISO 5855
Tolerance class: 4h-6h

	Insert Size		Pitch	Ordering Code	Market Description	Dimensions mm			Anvil	
	IC	L mm	mm	RH		h min	X	Y	RH	Toolholder
External	3/8"	16	1.0	3DTER1.0MJ... *	16DTER1.0MJ... *	0.58	1.5	0.7	YE3	AL....-3DT
			1.5	3DTER1.5MJ... *	16DTER1.5MJ... *	0.87	1.4	0.9		

* Available in Q2 2022

External

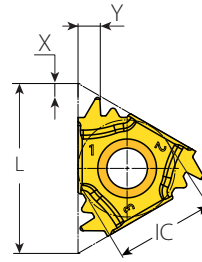

Metric Buttress

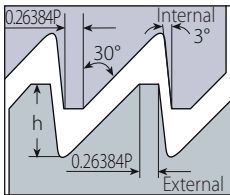

	Insert Size		Pitch	Ordering Code	Market Description	Dimensions mm			Anvil	
	IC	L mm	mm	RH		h min	X	Y	RH	Toolholder
External	3/8"	16	2.0	3DTER2.0SAGE... *	16DTER2.0SAGE... *	1.74	1.4	2.1	YE3	AL....-3DT

Defined by: DIN 513
Tolerance class: Medium Class

External

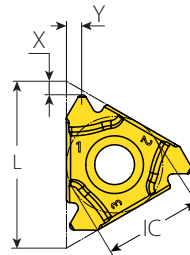

API Round

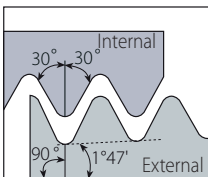

	Insert Size		Pitch	Ordering Code	Market Description	Dimensions mm			Anvil	
	IC	L mm	TPI	RH		h min	X	Y	RH	Toolholder
External	3/8"	16	10	3DTER10APIRD... *	16DTER10APIRD... *	1.41	1.4	1.3	YE3	AL....-3DT
			8	3DTER8APIRD... *	16DTER8APIRD... *	1.81	1.3	1.6		

Defined by: API SPEC. 5B
Tolerance class: Standard API RD

* Available in Q2 2022

External Toolholders

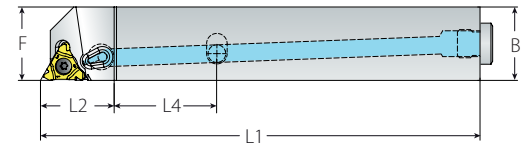
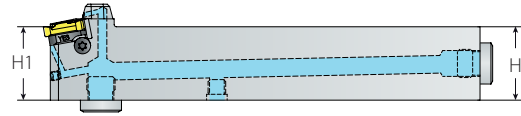
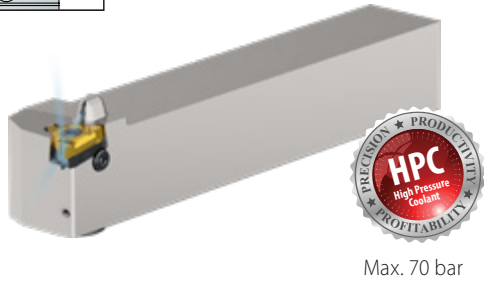
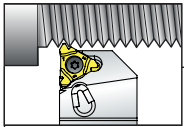

Standard with Coolant

Insert Size	Ordering Code	Market Description	Dimensions mm				Spare Parts						
IC	RH		H=H1=B	F	L1	L2	L4	Insert Screw	Anvil Screw	Torx Key	Anvil RH	Plug Screw x 2	Socket Screw
3/8"	ALCN16-3DT	ALCN16-16DT	16	16	100		25	SA3T (3.0 Nm)	SY3T	K3T	YE3	Plug G1/8"	Socket Screw M6x5
	ALCN20-3DT	ALCN20-16DT	20	20	125	25.4	30						
	ALCN25-3DT	ALCN25-16DT	25	25	150		35						
	ALCN32-3DT	ALCN32-16DT	32	32	170		35						

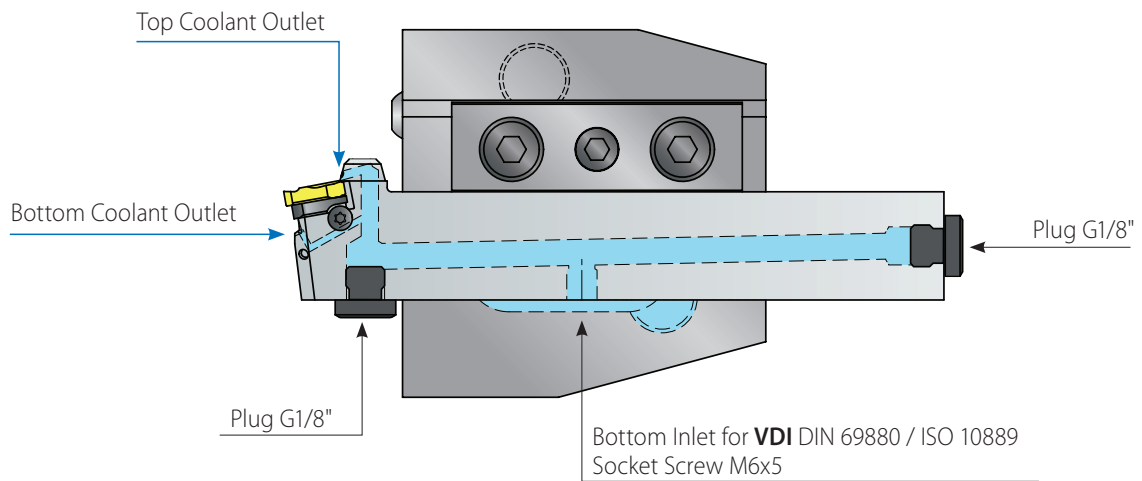

When reassembling the M6X5 plug, it is necessary to use LOCTITE 542.

The following HPC accessories (not included) can be ordered separately:

Image	Ordering Code	Item Number
	Tube Connector 25-6	013-00941
	Angled Fitting G1_8x6	013-00947
	Straight Fitting G1_8x6	013-00942

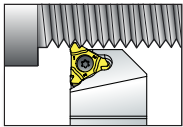

External Toolholders

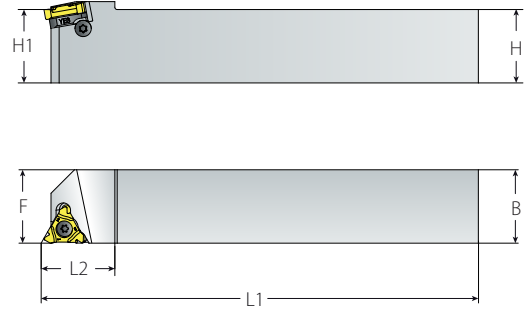
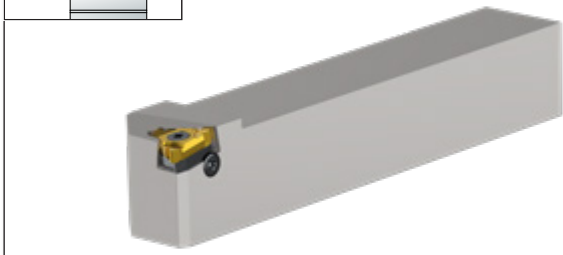

Standard

Insert Size	Ordering Code	Market Description	Dimensions mm			
IC	RH		H=H1=B	F	L1	L2
3/8"	AL12-3DT	AL12-16DT	12	12	84.5	20.7
	AL16-3DT	AL16-16DT	16	16	100	22.0
	AL20-3DT	AL20-16DT	20	20	127	24.5
	AL25-3DT	AL25-16DT	25	25	150	25.8
	AL32-3DT	AL32-16DT	32	32	170	29.5

Spare Parts

Insert Screw	Anvil Screw	Torx Key	Anvil RH
SA3T (3.0 Nm)	SY3T	K3T	YE3

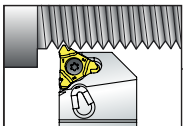

External Toolholders



Max. 70 bar

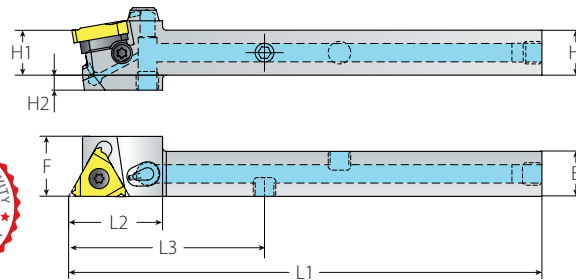

When reassembling the M6X5 plug, it is necessary to use LOCTITE 542.

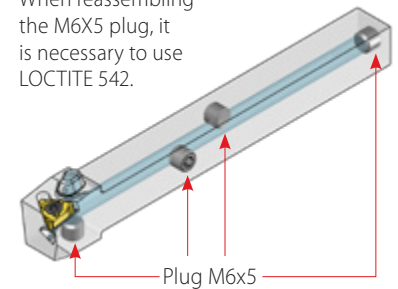

Standard with Coolant for Swiss Type Machines

Insert Size	Ordering Code	Market Description	Dimensions mm					
IC	RH		H=H1=B	F	L1	L2	L3	H2
3/8"	ALCS12-3DT	ALCS12-16DT	12	16	126.5	25.4	52.5	4

Spare Parts

Insert Screw	Anvil Screw	Torx Key	Anvil RH	Plug x 4
SA3T (3.0 Nm)	SY3T	K3T	YE3	Plug M6x5

The following HPC accessories (not included) can be ordered separately:

Image	Ordering Code	Item Number
	Tube Connector 25-6	013-00941
	Angled Fitting M6x6	013-01011
	Straight Fitting M6x6	013-01012
	Extender M6x5	013-01096
	Sealing Washer M6	013-01097

When working with Shank 12x12 the extender is necessary to connect the fitting.

How to Assemble the Accessories for Coolant Inlets on Shank 12x12

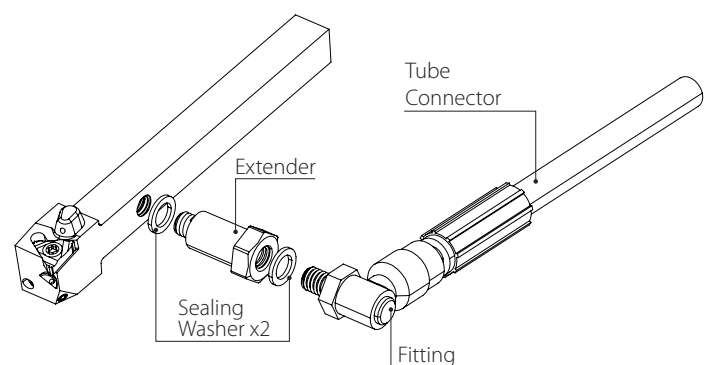

Recommended Cutting Speeds Vc [m/min] for MACH TT

Material Group	Vargus No.	Material	Hardness Brinell HB	Vc [m/min]	
				VK8	
P Steel	1	Unalloyed Steel	Low Carbon (C=0.1-0.25%)	125	115-175
	2		Medium Carbon (C=0.25-0.55%)	150	100-165
	3		High Carbon (C=0.55-0.85%)	170	90-155
	4	Low Alloy Steel (alloying elements ≤5%)	Non Hardened	180	100-165
	5		Hardened	275	75-130
	6		Hardened	350	70-125
	7	High Alloy Steel (alloying elements >5%)	Annealed	200	80-110
	8		Hardened	325	50-95
	9	Cast Steel	Low Alloy (alloying elements <5%)	200	70-120
	10		High Alloy (alloying elements >5%)	225	60-110
M Stainless Steel	11	Stainless Steel Ferritic	Non Hardened	200	70-120
	12		Hardened	330	60-105
	13	Stainless Steel Austenitic	Austenitic	180	90-130
	14		Super Austenitic	200	40-100
	15	Stainless Steel Cast Ferritic	Non Hardened	200	90-110
	16		Hardened	330	65-100
	17	Stainless Steel Cast Austenitic	Austenitic	200	85-100
	18		Hardened	330	60-100
K Cast Iron	28	Malleable Cast Iron	Ferritic (short chips)	130	60-70
	29		Pearlitic (long chips)	230	60-135
	30	Grey Cast Iron	Low Tensile Strength	180	70-120
	31		High Tensile Strength	260	60-105
	32	Nodular Sg Iron	Ferritic	160	125-145
	33		Pearlitic	260	90-110
N Non-Ferrous Metals	34	Aluminum Alloys Wrought	Non Aging	60	100-325
	35		Aged	100	80-205
	36	Aluminum Alloys	Cast	75	200-370
	37		Cast & Aged	90	200-260
	38	Aluminum Alloys	Cast Si 13-22%	130	60-165
	39	Copper and Copper Alloys	Brass	90	80-210
	40		Bronze And Non Lead Copper	100	80-235
	S Heat Resistant Material	19	High Temperature Alloys	Annealed (iron based)	200
20		Aged (iron based)		280	30-50
21		Annealed (nickel or cobalt based)		250	20-30
22		Aged (nickel or cobalt based)		350	15-25
23		Titanium Alloys	Pure 99.5 Ti	400Rm	140-160
24			α+β Alloys	1050Rm	50-70
H Hardened Material	25	Extra Hard Steel	Hardened & Tempered	45-50HRC	45-60
	26			51-55HRC	40-50

Grade	Application	Sample
VK8	High wear resistance for general purpose applications. AlTiN+TiN PVD Coating	

Number of Passes for MACH TT

Pitch	mm	0.70	0.75	1.00	1.25	1.50	1.75	2.00	2.50	3.00	3.50
	TPI	36	32	24	20	16	14	12	10	8	7
No. of passes - MACH TT		2-4	2-4	2-4	3-5	3-6	4-7	4-7	5-8	6-9	7-11
<i>In comparison (for your reference): No. of passes for Standard tools</i>		(4-7)	(4-7)	(4-8)	(5-9)	(6-10)	(7-12)	(7-12)	(8-14)	(9-16)	(10-18)



Infeed Method and Type of Passes

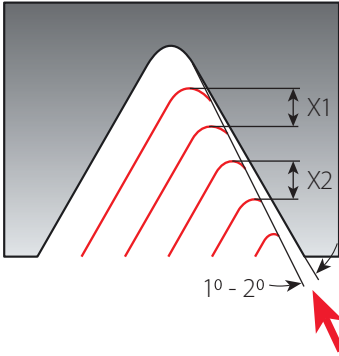

For MACH TT tools, it is recommended:

1. Use the flank infeed method (modified) with $1^\circ - 2^\circ$.
2. Use the constant depth type of passes. $X1 = X2$

Thread Turning Methods for Symmetrical Inserts

Thread	Inserts & Toolholder	Rotation	Feed Direction	Helix Method	Drawing
Right Hand External	EX RH	Counterclockwise	Towards chuck	Regular	A
Left Hand External	EX RH	Counterclockwise	From chuck	Reversed	B

MACH TT tools are designed for Right Hand applications, but can also be used for Left Hand threads.

External RH Thread (A)

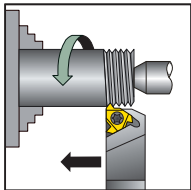

External LH Thread (B)

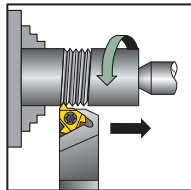

Anvils

	Resultant Helix Angle		2.5°	1.5°	0.5°
	Insert Size	Holder	Ordering Code		
	IC	L mm			
	3/8"	16	ER	YE3-1P	YE3-1N

Insert & Toolholder Combinations:

- | MACH toolholders are suitable with MACH inserts only
- | Standard toolholders can be used with MACH inserts but is less recommended

	MACH TT Insert	Standard Insert
MACH TT Toolholder		
Standard Toolholder		

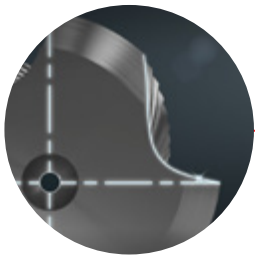

Improved Cutting Edge & Reinforced Geometry

For high loads

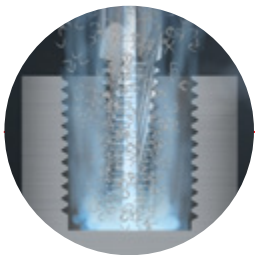

Coolant Thru

For better chip flow and surface finish



Large Core Diameter

For increased stability



Additional Flutes

For higher feed rate

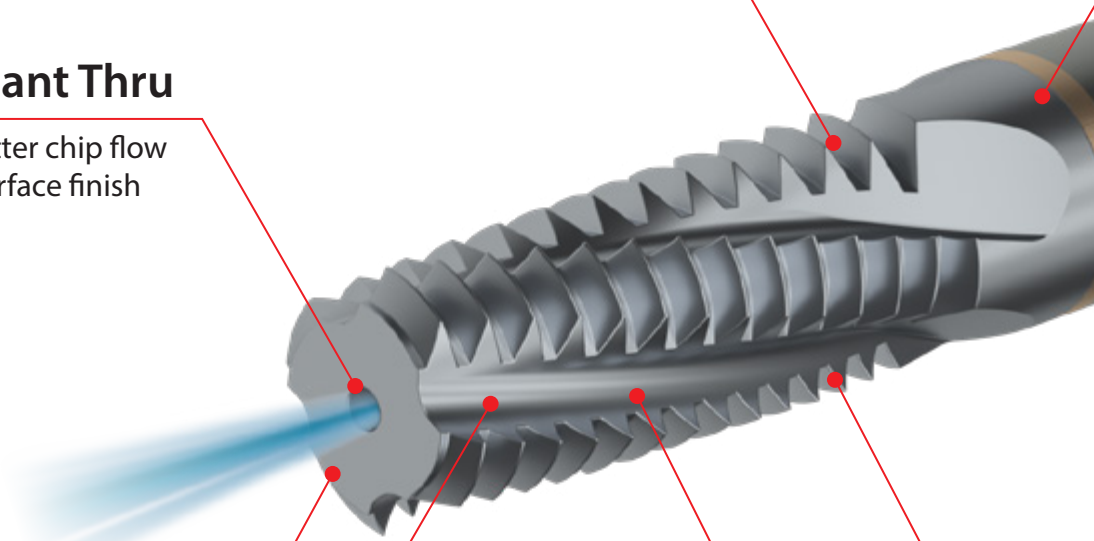



UNMATCHED PRODUCTIVITY

New Innovative VH4 Grade

High wear resistance for general purpose applications - TiCN PVD Coating

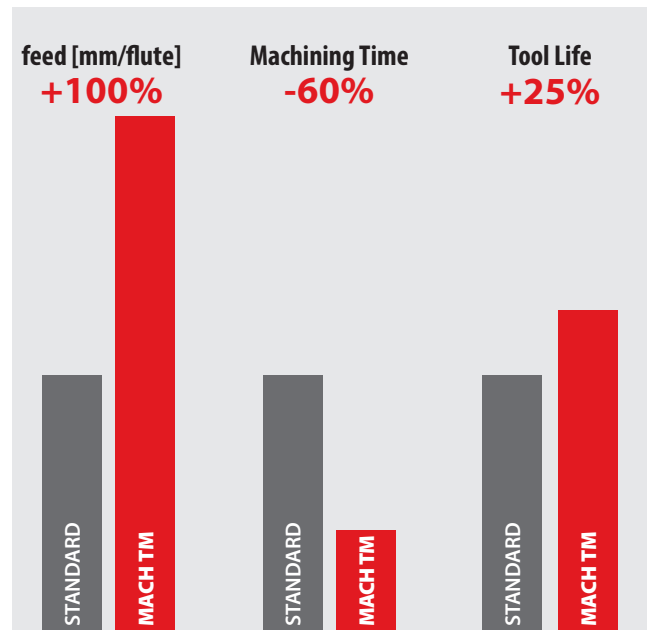
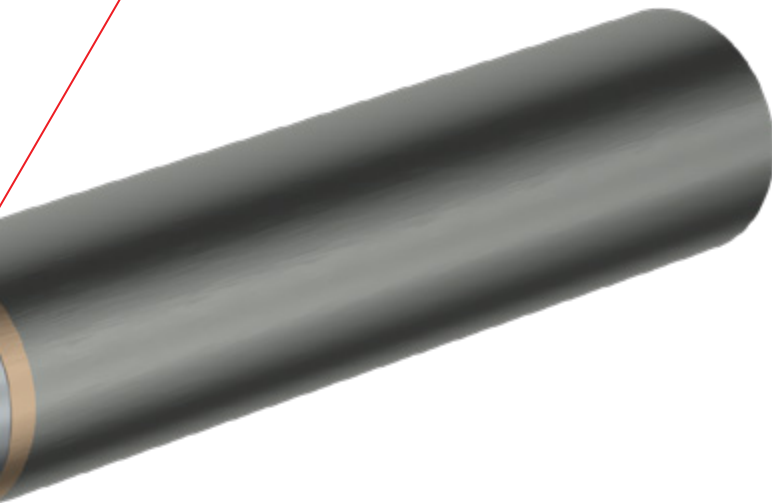
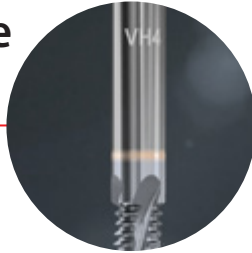

ADVANTAGES

- ✓ High feed mm/flute
- ✓ Dramatically decreases machining time
- ✓ Extended tool life
- ✓ Excellent surface finish

Advanced Surface Treatment

Reinforced cutting edge and improved surface finish

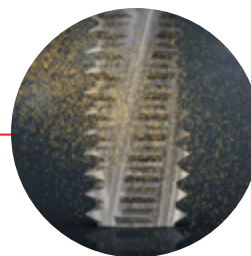

Optimal Flute Length

For higher rigidity and efficient chip evacuation

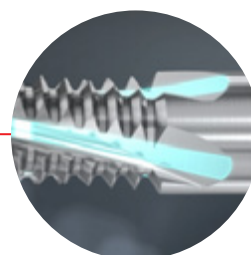

ISO Metric

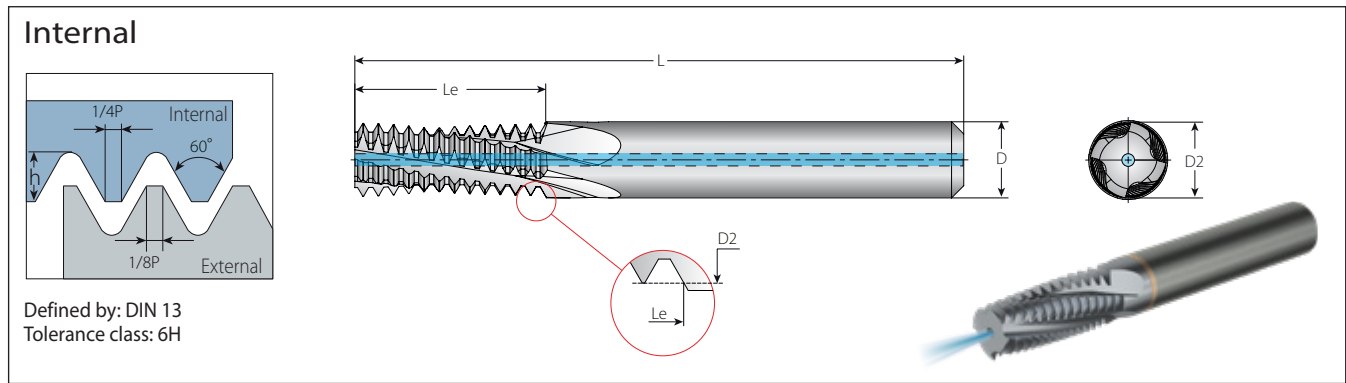

Helical Flutes with Thru-Hole Coolant

2 x Do (Le ≤ 2 x Thread Diameter)

Thread		Pitch	Ordering Code	Dimensions mm			No. of Flutes	Teeth	Bore Dia.**	
M Coarse	M Fine	mm	Internal	D	D2	L	Le	Z	Zt	mm
M3x0.5	M3.5-M16x0.5	0.5	HCF03024L06-I0.50ISOTM4	3	2.4	28.0	6.2	4	12	2.5
	M4x0.5	0.5	HCF03029L08-I0.50ISOTM4...	3	2.9	28.0	8.2	4	16	3.5
M4x0.7		0.7	HCF03029L08-I0.70ISOTM4...	3	2.9	30.0	8.7	4	12	3.3
	M6x0.75	0.75	HCF05049L12-I0.75ISOTM4...	5	4.9	40.0	12.4	4	16	5.3
M5x0.8		0.8	HCF04039L10-I0.80ISOTM4...	4	3.9	35.0	10.8	4	13	4.2
M6x1.0	M8-M40x1.0	1.0	HCF05048L12-I1.00ISOTM4...	5	4.8	41.0	12.5	4	12	5.0
M8x1.25		1.25	HCF06059L16-I1.25ISOTM4...	6	5.9	61.0	16.9	4	13	6.8
M10x1.5	M12-M48x1.5	1.5	HCF08079L20-I1.50ISOTM4...	8	7.9	64.0	20.2	4	13	8.5
M12x1.75		1.75	HCF10099L25-I1.75ISOTM5...	10	9.9	73.0	25.4	5	14	10.2
M14x2.0	M17-M80x2.0	2.0	HCF12116L29-I2.00ISOTM5...	12	11.6	80.0	29.0	5	14	12.0
M16x2.0	M17-M80x2.0	2.0	HCF12119L33-I2.00ISOTM5...	12	11.9	92.0	33.0	5	16	14.0
M20x2.5		2.5	HCF16159L41-I2.50ISOTM5...	16	15.9	102.0	41.2	5	16	17.5

** Bore diameter applies to smallest thread dia.

American UN

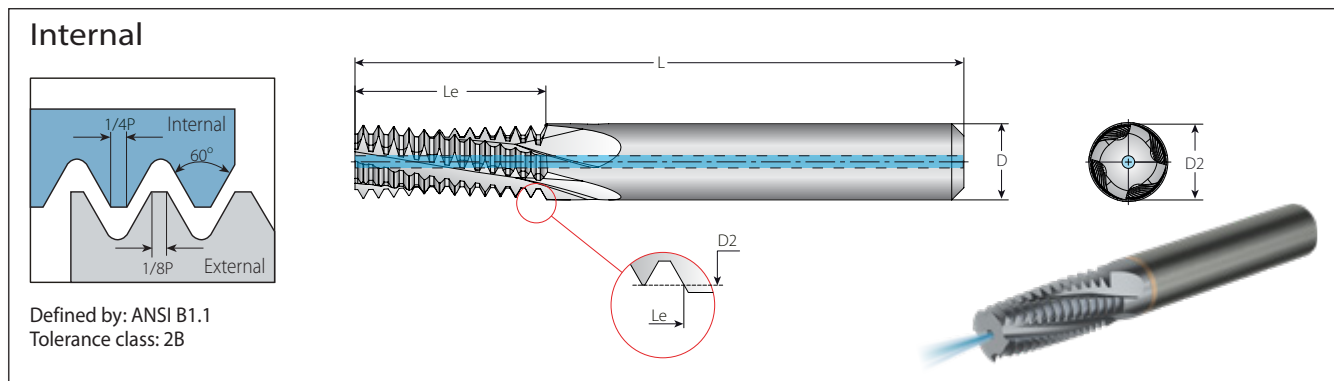

Helical Flutes with Thru-Hole Coolant

2 x Do (Le ≤ 2 x Thread Diameter)

Thread			Pitch	Ordering Code	Dimensions mm			No. of Flutes	Teeth	Bore Dia.**	
UNC	UNF	UNEF	TPI	Internal	D	D2	L	Le	Z	Zt	mm
	1/4"x28	7/16"-1/2"x28	28	HCF05049L13-I28UNTM4... *	5	4.90	40	13.1	4	14	5.5
	5/16"; 3/8"x24	9/16"-11/16"x24	24	HCF06059L16-I24UNTM4... *	6	5.90	59	16.4	4	15	6.8
	3/8"x24	9/16"-11/16"x24	24	HCF08079L19-I24UNTM4... *	8	7.90	62	19.6	4	18	8.5
1/4"-20	7/16"; 1/2"x20	3/4"-1"x20	20	HCF05049L13-I20UNTM4... *	5	4.90	41	13.3	4	10	5.2
	7/16"; 1/2"x20	3/4"-1"x20	20	HCF10096L22-I20UNTM4... *	10	9.60	72	22.2	4	17	9.8
5/16"x18	9/16"; 5/8"x18	11/16"-1 1/16"x18	18	HCF06059L16-I18UNTM4... *	6	5.90	59	16.2	4	11	6.5
3/8"x16	3/4"x16		16	HCF08076L19-I16UNTM4... *	8	7.60	64	19.8	4	12	8.0
7/16"x14	7/8"x14		14	HCF08078L22-I14UNTM4... *	8	7.80	67	22.7	4	12	9.3
1/2"x13			13	HCF10099L26-I13UNTM5... *	10	9.90	75	26.4	5	13	10.8
9/16"x12	1"-1 1/2"x12		12	HCF12118L28-I12UNTM5... *	12	11.80	83	28.6	5	13	12.3
5/8"x11			11	HCF14131L33-I11UNTM5... *	14	13.10	90	33.5	5	14	13.5
3/4"x10			10	HCF16159L39-I10UNTM5... *	16	15.90	98	39.4	5	15	16.5
1x8"			8	HCF20199L52-I8UNTM5... *	20	19.90	107	52.4	5	16	22.0

BSP

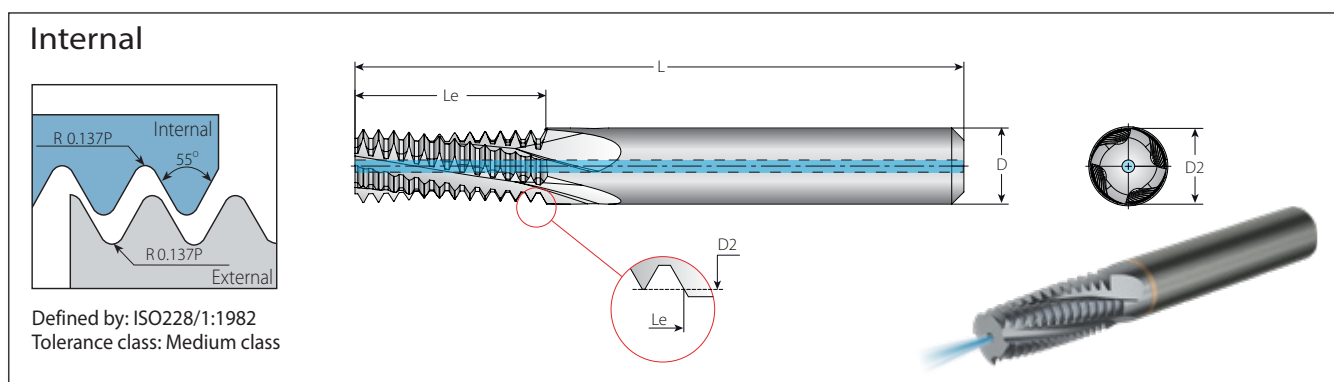

Helical Flutes with Thru-Hole Coolant

2 x Do (Le ≤ 2 x Thread Diameter)

Thread	Pitch	Ordering Code	Dimensions mm			No. of Flutes	Teeth	Bore Dia.	
Standard	TPI	Internal	D	D2	L	Le	Z	Zt	mm
1/8"x28	28	HCF08079L19-EI28BSPTM4... *	8	7.90	62	19.5	4	21	8.7
1/4"x19, 3/8"x19	19	HCF10099L27-EI19BSPTM5... *	10	9.90	75	27.4	5	20	11.8, 15.2
1/2"x14, 3/4"x14	14	HCF16159L42-EI14BSPTM5... *	16	15.90	99	42.6	5	23	19.0, 24.4

* Available in Q1 2022

** Bore diameter applies to smallest thread dia.

NPT

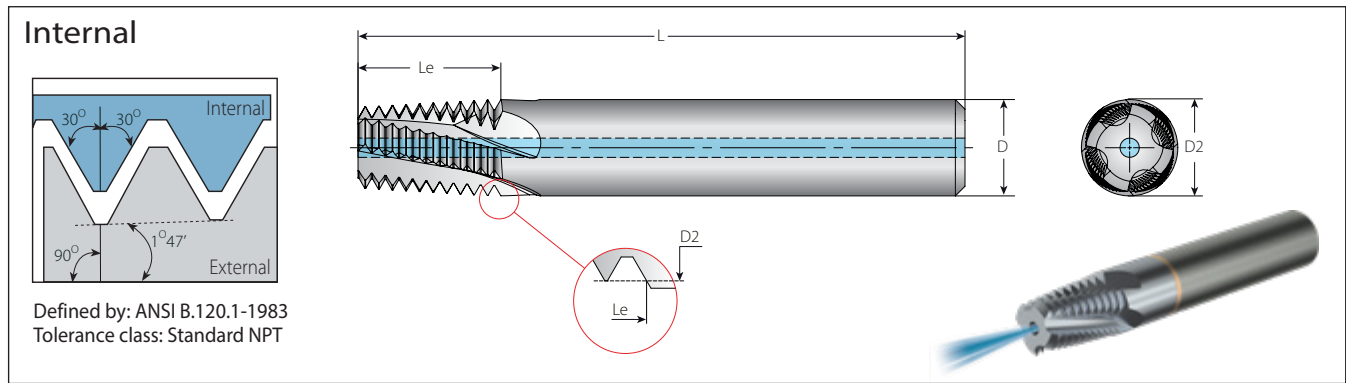

Helical Flutes with Thru-Hole Coolant

Thread	Pitch	Ordering Code	Dimensions mm				No. of Flutes	Teeth	Bore Dia.
			D	D2	L	Le			
Standard	TPI	Internal	D	D2	L	Le	Z	Zt	mm
1/16"x27	27	HCF06059L09-EI27NPT-TM4... *	6.00	5.90	53	9.9	4	10	6.3
1/8"x27	27	HCF08076L09-EI27NPT-TM4... *	8.00	7.65	53	9.9	4	10	8.5
1/4"x18, 3/8"x18	18	HCF10099L14-EI18NPT-TM4... *	10.00	9.90	63	14.8	4	10	11.1, 14.5
1/2"; 3/4"x14	14	HCF14139L19-EI14NPT-TM5... *	14.00	13.90	75	19.0	5	10	17.7, 23.0
1", 1 1/4", 1 1/2", 2", x11.5	11.5	HCF18179L23-EI11.5NPT-TM5... *	18.00	17.90	80	23.2	5	10	29.0, 37.7, 44.0, 56.0

* Available in Q1 2022



Recommended Cutting Speeds Vc [m/min] and Feed f [mm/tooth] for MACH TM

Material Group	Vargus No.	Material	Hardness Brinell HB	Vc [m/min]				Feed f [mm/tooth]		
				VH4	D2≤4 mm	D2≤8 mm	D2>8 mm	D2≤4 mm	D2≤8 mm	D2>8 mm
P Steel	1	Unalloyed Steel	Low Carbon (C=0.1-0.25%)	125	80-250	0.04-0.08	0.09-0.13	0.06-0.20		
	2		Medium Carbon (C=0.25-0.55%)	150	80-230	0.04-0.08	0.09-0.13	0.06-0.20		
	3		High Carbon (C=0.55-0.85%)	170	80-200	0.04-0.08	0.09-0.13	0.06-0.20		
	4	Low Alloy Steel (alloying elements≤5%)	Non Hardened	180	60-180	0.04-0.08	0.09-0.13	0.06-0.20		
	5		Hardened	275	60-170	0.04-0.08	0.09-0.13	0.06-0.20		
	6	High Alloy Steel (alloying elements>5%)	Annealed	350	60-160	0.03-0.06	0.05-0.10	0.06-0.12		
	7		Hardened	200	40-100	0.04-0.08	0.09-0.13	0.06-0.20		
	8	Cast Steel	Low Alloy (alloying elements <5%)	325	30-80	0.03-0.06	0.05-0.10	0.06-0.12		
	9		High Alloy (alloying elements >5%)	200	80-250	0.04-0.08	0.09-0.13	0.06-0.20		
	M Stainless Steel	10	Stainless Steel Ferritic	Non Hardened	225	60-170	0.04-0.08	0.09-0.13	0.06-0.20	
11		Hardened		200	60-150	0.03-0.06	0.05-0.10	0.06-0.12		
12		Stainless Steel Austenitic	Austenitic	330	60-120	0.015-0.03	0.03-0.05	0.02-0.06		
13			Super Austenitic	180	60-140	0.04-0.08	0.09-0.13	0.06-0.20		
14		Stainless Steel Cast Ferritic	Non Hardened	200	60-130	0.03-0.06	0.05-0.10	0.06-0.12		
15			Hardened	200	60-160	0.03-0.06	0.05-0.10	0.06-0.12		
16		Stainless Steel Cast Austenitic	Non Hardened	330	60-110	0.03-0.06	0.05-0.10	0.06-0.12		
17			Hardened	200	60-150	0.03-0.05	0.05-0.10	0.05-0.11		
18	Stainless Steel Cast Austenitic	Austenitic	330	60-100	0.015-0.03	0.03-0.05	0.02-0.06			
19		Hardened	200	60-100	0.015-0.03	0.03-0.05	0.02-0.06			
K Cast Iron	28	Malleable Cast Iron	Ferritic (short chips)	130	60-70	0.04-0.08	0.09-0.13	0.06-0.20		
	29		Pearlitic (long chips)	230	60-150	0.04-0.08	0.09-0.13	0.06-0.20		
	30	Grey Cast Iron	Low Tensile Strength	180	70-160	0.04-0.08	0.09-0.13	0.06-0.20		
	31		High Tensile Strength	260	40-120	0.03-0.06	0.05-0.10	0.06-0.12		
	32	Nodular Sg Iron	Ferritic	160	40-110	0.04-0.08	0.09-0.13	0.06-0.20		
	33		Pearlitic	260	40-100	0.03-0.06	0.05-0.10	0.06-0.12		
N Non-Ferrous Metals	34	Aluminum Alloys Wrought	Non Aging	60	200-300	0.06-0.11	0.10-0.17	0.09-0.20		
	35		Aged	100	150-250	0.03-0.09	0.05-0.12	0.05-0.14		
	36	Aluminum Alloys	Cast	75	100-200	0.06-0.11	0.10-0.17	0.09-0.20		
	37		Cast & Aged	90	120-220	0.03-0.09	0.05-0.12	0.05-0.14		
	38	Aluminum Alloys	Cast Si 13-22%	130	200-300	0.06-0.11	0.10-0.17	0.09-0.20		
	39	Copper and Copper Alloys	Brass	90	200-300	0.06-0.11	0.10-0.17	0.09-0.20		
	40		Bronze And Non Leaded Copper	100	150-250	0.03-0.09	0.05-0.12	0.05-0.14		
	S Heat Resistant Material	19	High Temperature Alloys	Annealed (iron based)	200	30-60	0.03-0.06	0.05-0.10	0.06-0.12	
20		Aged (iron based)		280	20-50	0.015-0.03	0.03-0.05	0.02-0.06		
21		Annealed (nickel or cobalt based)		250	15-35	0.015-0.03	0.03-0.05	0.02-0.06		
22		Aged (nickel or cobalt based)		350	15-30	0.015-0.03	0.03-0.05	0.02-0.06		
23		Titanium Alloys	Pure 99.5 Ti	400Rm	40-80	0.015-0.03	0.03-0.05	0.02-0.06		
24			α+β Alloys	1050Rm	20-50	0.015-0.03	0.03-0.05	0.02-0.06		

Pitch		No. of Passes
mm	TPI	
≤1.75	≤14	1
≥1.75-2.0	≥14-12	2
≥2.0	≥12	Multi-passes

To use higher feed from the range, the depth of the pre-drilled hole is recommended to be increased by 2-3 pitches of thread.

Grade	Application	Sample
VH4	High wear resistance for general purpose applications. TiCN PVD Coating	

FS LINE

Fully Sintered Inserts

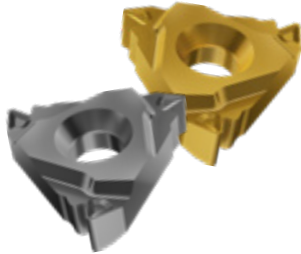

ALCN

External Thread Turning Toolholders with Two High Pressure Coolant Outlets



ALCS

External Thread Turning Toolholders for Swiss Type Machines with High Pressure Coolant (HPC)



V-CAP

Internal & External Toolholders for IC1/2" (22)

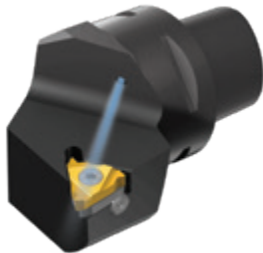

SMOOTH CUT SYSTEM

Modular Toolholder Heads for Anti-Vibration Shanks

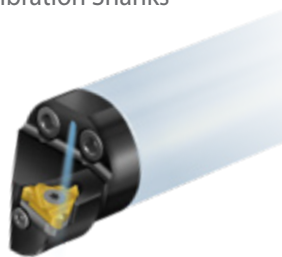

TMSD

Modular Toolholder Heads

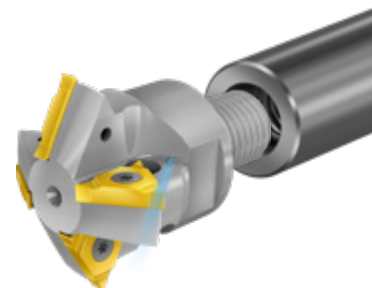

MITM Offset

Fast Machining for Large Pitches in Deep Holes

PATENT PENDING

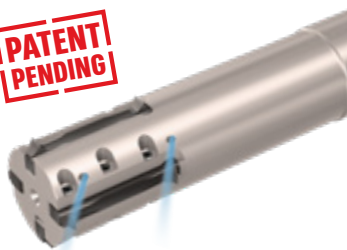

TM Solid MultiFlute

Helicool Tools
Increased Number of Flutes for Faster Machining



TM Solid TMDR

Drilling, Thread Milling & Chamfering

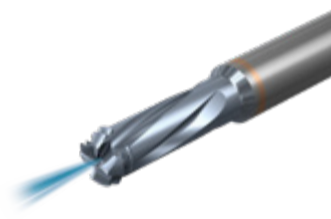

TM Solid Millipro Dental

Reinforced Miniature Thread Mills for Dental Implants

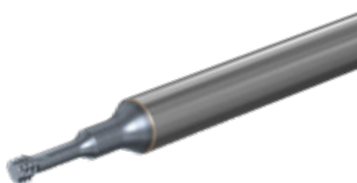

V-TAPS

Advanced Tapping Solutions



V-WHIRLING

High precision whirling system for medical and micromachining applications



With a network of 13 international companies and hundreds of distributors, warehouses and certified ISO 9001 manufacturing facilities, VARGUS Ltd. serves customers in more than 100 countries around the globe. A customer-focused organization, VARGUS Ltd. is committed to providing innovative products and solutions of the highest quality and excellent value, and is renowned for its technical expertise and uncompromising service.

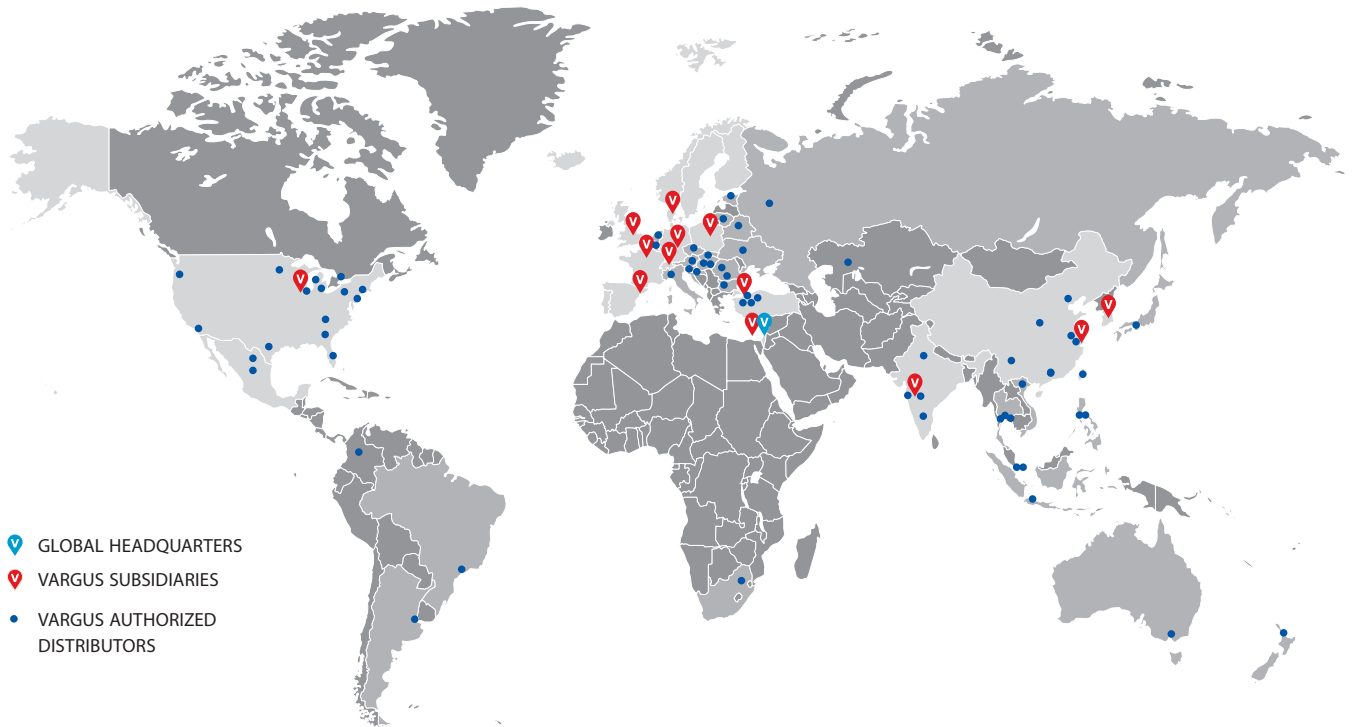

VARGUS Ltd. - Global Headquarters | ISRAEL +972 4 9855 101 | mrktg@vargus.com

EUROPE

 **DENMARK**
VARGUS Scandinavia
+45 8794 4100
vargus@vargus.dk

 **FRANCE**
VARGUS France
+33 1 4601 7060
commercial@vargus.fr

 **GERMANY**
VARGUS Germany
+49 7043 36 161
info@vargus.de

 **ISRAEL**
NEUMO-VARGUS
+972 3 537 3275
neumo@neumo-vargus.co.il

 **POLAND**
VARGUS Poland
+48 46 834 9904 / 46 831 5140
vargus@neumo.pl

 **SPAIN**
VARGUS Ibérica
+34 977 52 49 00
sales@vargus.es

 **SWITZERLAND**
VARGUS Switzerland
+41 41784 2121
info@vargus.ch

 **TURKEY**
VARGUS Turkey
+90 212 875 01 41
info@vargusturkey.com

 **UNITED KINGDOM**
VARGUS Tooling UK
+44 1952 583 222
tooling.uk@vargustooling.co.uk

ASIA

 **CHINA**
VARGUS China
+86 21 516 88300
info@varguschina.net

 **INDIA**
VARGUS India
+91 2135 654748
info@vargusindia.com

 **SOUTH KOREA**
VARGUS Korea
+82 31 660 7092
info@varguskorea.co.kr

NORTH AMERICA

 **USA**
VARGUS USA
+1 800 828 8765 / 608 756 4930
sales@vargususa.com

